



US00D780738S

(12) **United States Design Patent**
Barfoot et al.

(10) **Patent No.:** **US D780,738 S**
(45) **Date of Patent:** **** Mar. 7, 2017**

(54) **PHONE CASE**

- (71) Applicant: **Magpul Industries Corp**, Boulder, CO (US)
- (72) Inventors: **Grady Barfoot**, Denver, CO (US); **Richard M. Fitzpatrick**, Longmont, CO (US); **Michael T. Mayberry**, Denver, CO (US)
- (73) Assignee: **MAGPUL INDUSTRIES CORP.**, Austin, TX (US)

(**) Term: **14 Years**

(21) Appl. No.: **29/485,779**

(22) Filed: **Mar. 21, 2014**

(51) **LOC (10) Cl.** **14-01**

(52) **U.S. Cl.**

USPC **D14/250**

(58) **Field of Classification Search**

USPC D14/250-253, 440, 203.3-203.7, 217, D14/496, 248, 238.1, 240, 447, 230, 247, D14/341, 345, 346, 439; D3/201, 218, D3/269, 301, 273, 303, 247, 249; D13/103, 107-108, 119; D11/178.1; D19/10; 361/679.56; 379/426, 433.11, 379/455; 455/75.1, 575.8; 190/100; 206/305, 320; 220/4.02; 248/309.1
CPC . A45C 2011/002; A45C 11/00; A45C 13/002; A45C 2011/003; H04M 1/0283; H04M 1/0202

See application file for complete search history.

(56) **References Cited**

U.S. PATENT DOCUMENTS

- D150,654 S 8/1948 Raphaels
- 5,360,108 A 11/1994 Alagia
- D382,111 S 8/1997 Bardus et al.

(Continued)

OTHER PUBLICATIONS

Young-Mok, Yoo, "Korean Notice of Preliminary Rejection re Application No. 30-2014-0037870", Feb. 11, 2015, p. 3, Published in: KR.

(Continued)

Primary Examiner — Sandra Snapp

Assistant Examiner — Holly E Thurman

(74) *Attorney, Agent, or Firm* — Neugeboren O'Dowd PC

(57) **CLAIM**

The ornamental design for a phone case, as shown and described.

DESCRIPTION

FIG. 1 is a left, top, front perspective view of a phone case showing our new design;
 FIG. 2 is a left, top, front perspective view of the phone case of FIG. 1;
 FIG. 3 is a right, top, rear perspective view of the phone case of FIG. 1;
 FIG. 4 is a front elevation view of the phone case of FIG. 1;
 FIG. 5 is a rear elevation view of the phone case of FIG. 1;
 FIG. 6 is a right side elevation view of the phone case of FIG. 1;
 FIG. 7 is a left side elevation view of the phone case of FIG. 1;
 FIG. 8 is a top plan view of the phone case of FIG. 1; and,
 FIG. 9 is a bottom plan view of the phone case of FIG. 1.
 The broken lines showing portions of the design in all figures are included for the purpose of illustrating environment and unclaimed features and forms no part of the claimed design.

1 Claim, 7 Drawing Sheets

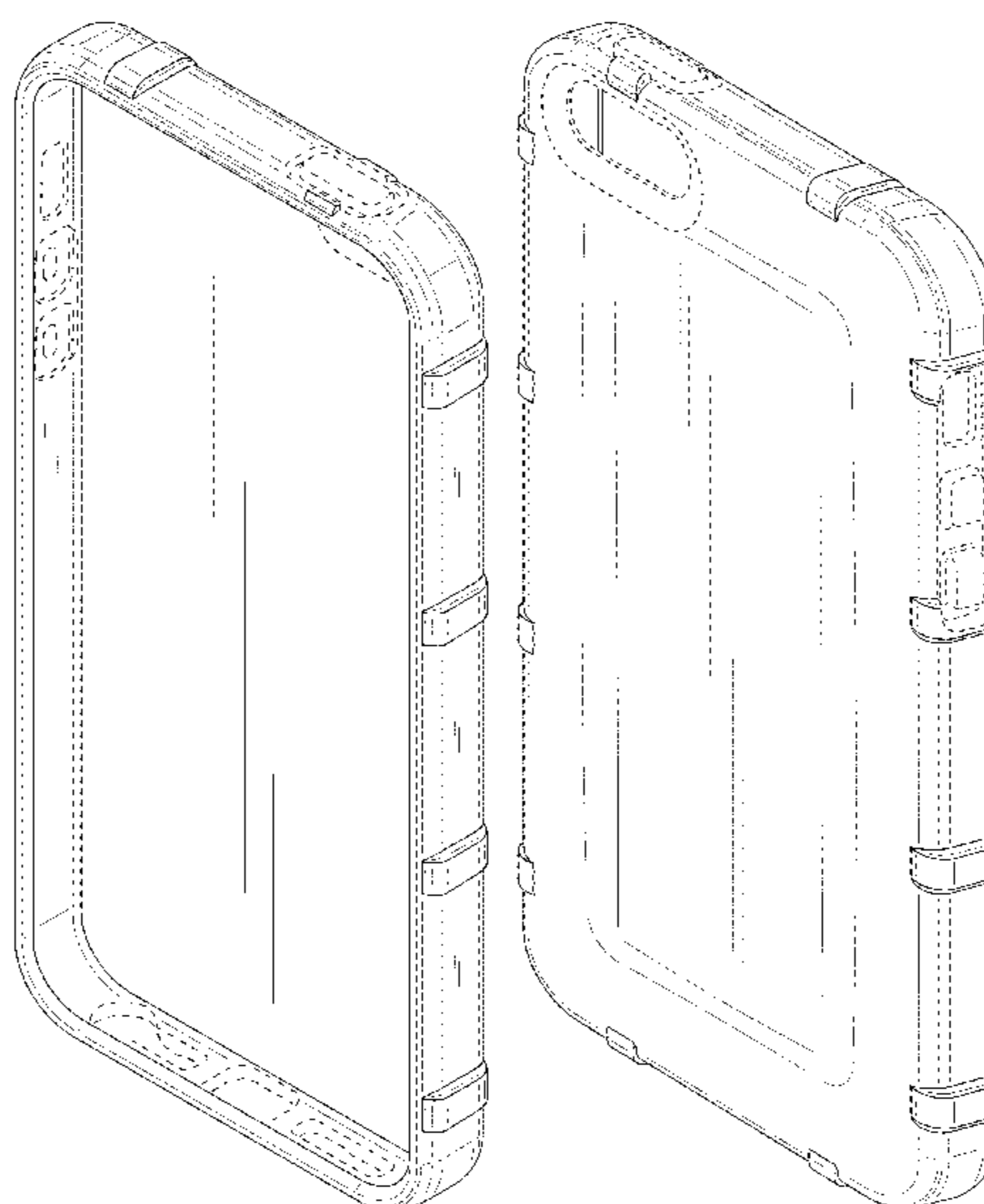

(56)

References Cited

OTHER PUBLICATIONS

U.S. PATENT DOCUMENTS

D419,297 S 1/2000 Richardson et al.
 D419,767 S 2/2000 Richardson et al.
 D419,768 S * 2/2000 Richardson D3/273
 D422,787 S * 4/2000 Feng D3/273
 D455,746 S 4/2002 Ronzani et al.
 D514,123 S 1/2006 Naruki et al.
 D516,309 S * 3/2006 Richardson D3/273
 D516,807 S * 3/2006 Richardson D3/273
 D524,046 S * 7/2006 Pangerc D3/273
 7,158,376 B2 1/2007 Richardson et al.
 D553,352 S 10/2007 Allen
 D556,681 S 12/2007 Kim
 D575,056 S 8/2008 Tan
 D581,421 S 11/2008 Richardson et al.
 D592,646 S 5/2009 Sun et al.
 D602,894 S 10/2009 Lepoultier et al.
 D606,531 S 12/2009 Ferrari et al.
 D607,444 S 1/2010 Ferrari et al.
 D615,078 S 5/2010 Bradley
 D615,536 S 5/2010 Richardson et al.
 D619,574 S 7/2010 Richardson et al.
 D622,716 S 8/2010 Andre et al.
 D623,180 S 9/2010 Diebel
 D623,640 S 9/2010 Freeman
 D625,698 S 10/2010 Miyazaki et al.
 D626,540 S 11/2010 Brown et al.
 7,859,222 B2 12/2010 Woud
 D633,164 S 2/2011 Fitzpatrick et al.
 D633,589 S 3/2011 Fitzpatrick et al.
 D634,313 S 3/2011 Fitzpatrick et al.
 D635,555 S 4/2011 Giles
 D637,592 S 5/2011 Magness et al.
 D638,006 S 5/2011 Chang
 D638,007 S 5/2011 Chang
 D638,830 S 5/2011 Magness et al.
 D643,029 S 8/2011 Feng
 D643,433 S 8/2011 Hsieh et al.
 D650,371 S 12/2011 Wibby et al.
 D651,203 S 12/2011 Michie et al.
 D655,281 S 3/2012 Turocy
 D662,925 S 7/2012 Mayberry et al.
 D681,624 S * 5/2013 Chang D14/250
 D685,357 S * 7/2013 Rekuc D14/250
 D688,233 S * 8/2013 Dong D14/250
 D689,851 S * 9/2013 Chang D14/250
 D695,378 S * 12/2013 Fitzpatrick D22/108
 8,706,176 B1 * 4/2014 Jia H04M 1/04
 206/305
 D705,886 S * 5/2014 Kielsmeier D22/108
 D706,272 S * 6/2014 Poon D14/440
 D706,880 S * 6/2014 Chu D21/573
 D707,783 S * 6/2014 Kielsmeier D22/108
 D718,294 S * 11/2014 Barfoot D14/250
 D718,756 S * 12/2014 Barfoot D14/250
 D718,759 S * 12/2014 Barfoot D14/250
 D719,145 S * 12/2014 Barfoot D14/250
 D721,370 S * 1/2015 Barfoot D14/400
 D724,691 S * 3/2015 Barfoot D22/109
 D728,727 S * 5/2015 Barfoot D22/109
 D728,728 S * 5/2015 Barfoot D22/109
 D731,494 S * 6/2015 Barfoot D14/440
 2010/0008028 A1 * 1/2010 Richardson G06F 1/1626
 361/679.01
 2010/0224519 A1 9/2010 Kao
 2010/0251590 A1 * 10/2010 Fitzpatrick F41A 9/65
 42/50

Chattopadhaya, Dr. Sukanya, "First Examination Report re Indian Application No. 265358", Nov. 12, 2014, p. 2, Published in: IN.
 "Targus Slim Fit Case for iPhone 5s/5," webpage accessed at <http://targus.com/US/-slim-fit-case-for-iphone-5s5-blue-thd03102us>, downloaded on Jun. 25, 2014, Publisher: Targus Store, USA, 1 page.
 "Speck PixelSkin HD Cases for iPhone 5s & iPhone 5," webpage accessed at <http://www.speckproducts.com/iphone-case/iphone-5-cases/pixelskin-hd-for-iphone-5.html>, downloaded on Jun. 25, 2014, Publisher: Speck Products, 5 pages.
 "Speck PixelSkin Cases for iPhone 5s & iPhone 5," webpage accessed at <http://www.speckproducts.com/iphone-case/iphone-5-cases/pixelskin-for-iphone-5.html>, downloaded on Jun. 25, 2014, Publisher: Speck Products, 5 pages.
 "Kate Spade New York Bow Pocket Silicone Phone Case for iPhone 5," webpage accessed at <http://couture.zappos.com/kate-spade-new-york-bow-pocket-silicone-phone-case-for-iphone-5-geranium>, downloaded on Jun. 25, 2014, Publisher: Zappos.com, 1 page.
 "Frequency Flexible Textured Impact Resistant Case for iPhone 5s," webpage accessed at <http://www.incipio.com/cases/iphone-cases/iphone-5s-cases/frequency-case-for-iphone-5s.html>, downloaded on Jun. 25, 2014, Publisher: Incipio Technologies, 2 pages.
 "Black Vector TPU case for iPhone 5," webpage accessed at <http://us.cygnett.com/iPhone-5S/Black-Vector-TPU-Case-for-iPhone-5>, downloaded Jun. 25, 2014, Publisher: Cygnett, 1 page.
 "Canyon Orange Bulldozer Silicone Case for iPhone 5," webpage accessed at <http://us.cygnett.com/iPhone-5S/Canyon-Orange-Bulldozer-Silicone-Case-for-iPhone-5>, downloaded Jun. 25, 2014, Publisher: Cygnett, 1 page.
 Guy, N., "Review: Magpul Executive Field Case for iPhone 4," webpage accessed at <http://www.ilounge.com/index.php/reviews/entry/magpul-executive-field-case-for-iphone-4>, known to exist Jun. 29, 2011, Publisher: iLounge, 5 pages.
 Policestore.com, "Magpul iPhone Cases," webpage accessed at <http://www.policestore.com/duty-gear-apparel/pouches-cases/electronic-device-cases/magpul-iphone-cases-prod42016.aspx>, known to exist Mar. 25, 2012, Publisher: Brownwells, Inc., 3 pages.
 Magpul, "Executive Field Case—iPhone 4," webpage accessed at <https://web.archive.org/web/20110925005145/http://store.magpul.com/product/MAG450/125>, known to exist Jan. 17, 2011, Publisher: Magpul Industries Corp., 2 pages.
 Magpul, "Magpul Field Case—iPhone 5/5s," webpage accessed at <http://store.magpul.com/product/MAG452/125>, downloaded Jun. 26, 2014, Publisher: Magpul Industries Corp., 1 page.
 "Case Mate CM 011706 Medley Case for iPhone 4—Black," webpage accessed at <http://www.amazon.co.uk/Case-Mate-CM011706-Medley-iPhone/dp/B003XDU8S0>, downloaded Jun. 26, 2014, Publisher: Amazon.com, 3 pages.
 "Incipio Bombproof Silicone Case for iPhone 4 (AT&T and Verizon)—Red," webpage accessed at <http://www.amazon.ca/Incipio-BOMBPROOF-Silicone-iPhone-Verizon/dp/B003SX0P4W>, downloaded Jun. 26, 2014, Publisher: Amazon.com, 3 pages.
 Boyd, Jodie, "Design Application Pre-Registration Formalities Check Notice Application No. 201414742", Oct. 6, 2014, p. 2, Published in: AU.
 Wu, Xia, "Canadian Office Action re Application No. 158004", Mar. 13, 2015, p. 3, Published in: CA.
 Dekleine, Geoffrey, "Response to Canadian Office Action re Application No. 158004", Apr. 15, 2015, p. 2, Published in: CA.

* cited by examiner

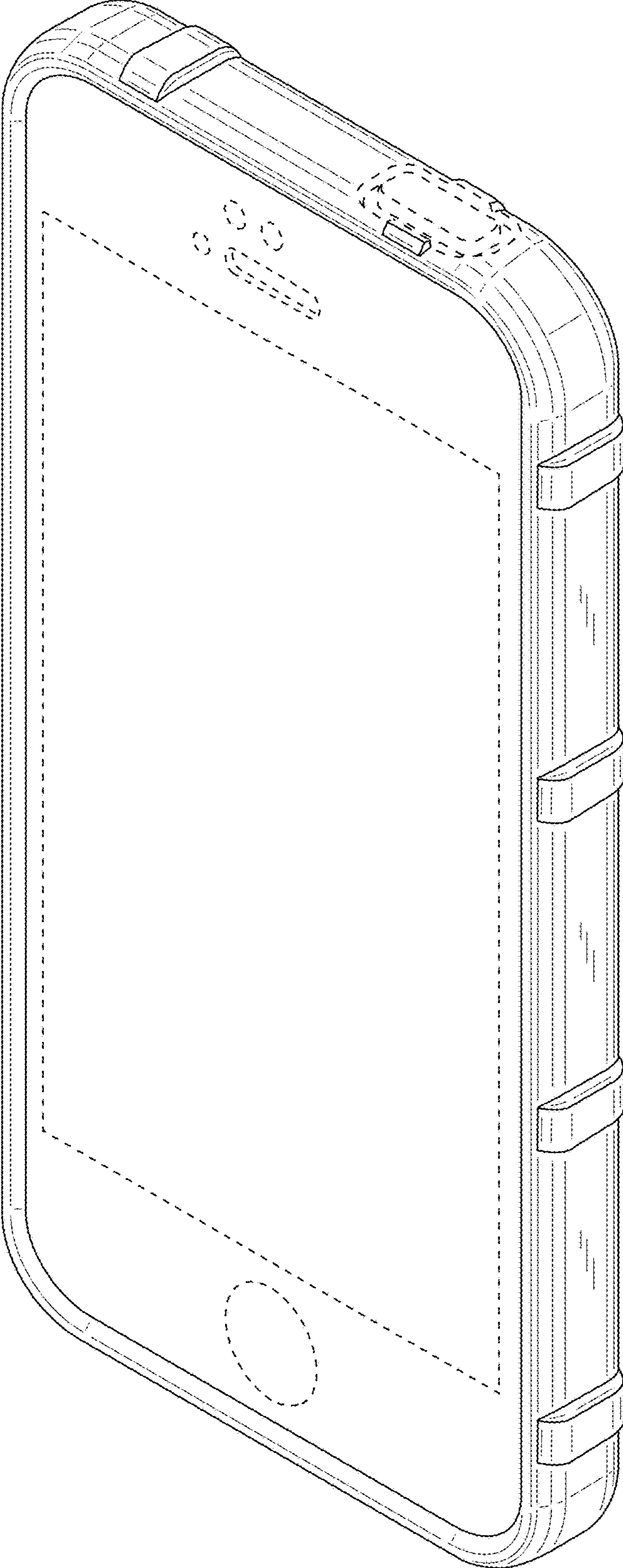

FIG. 1

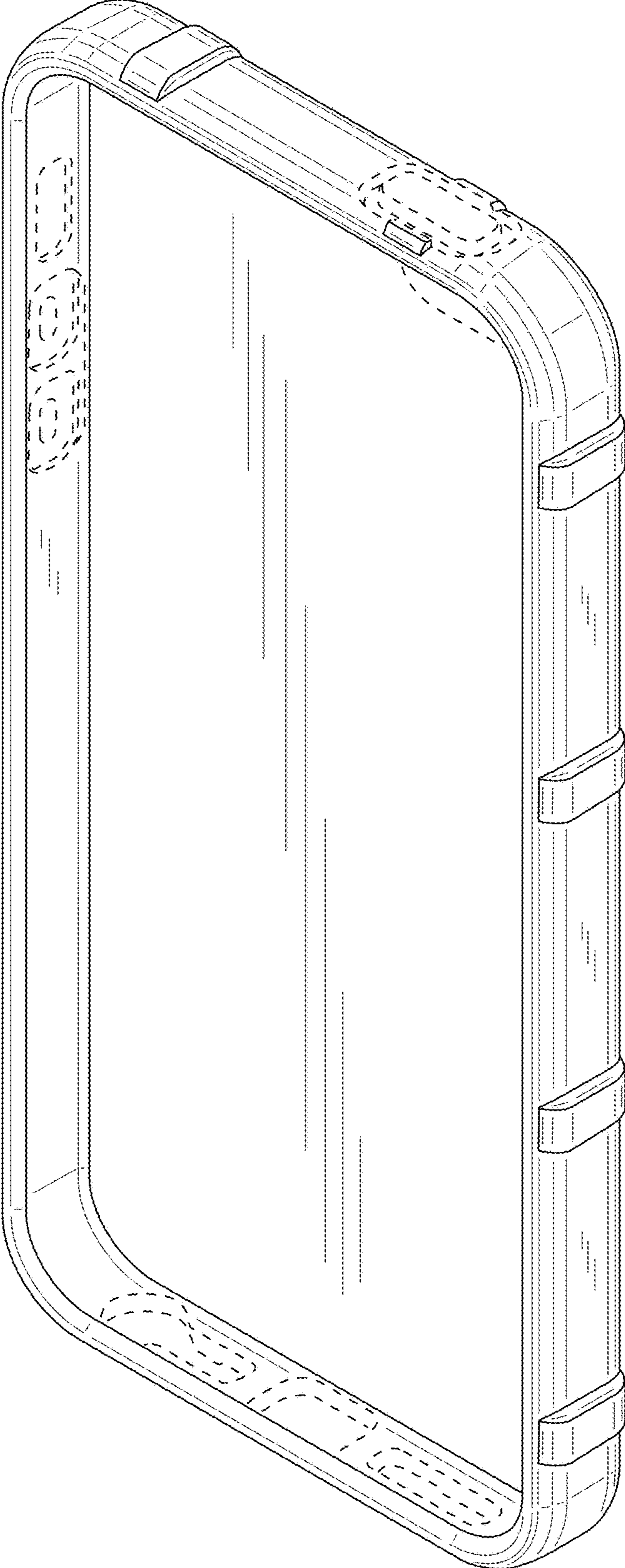

FIG. 2

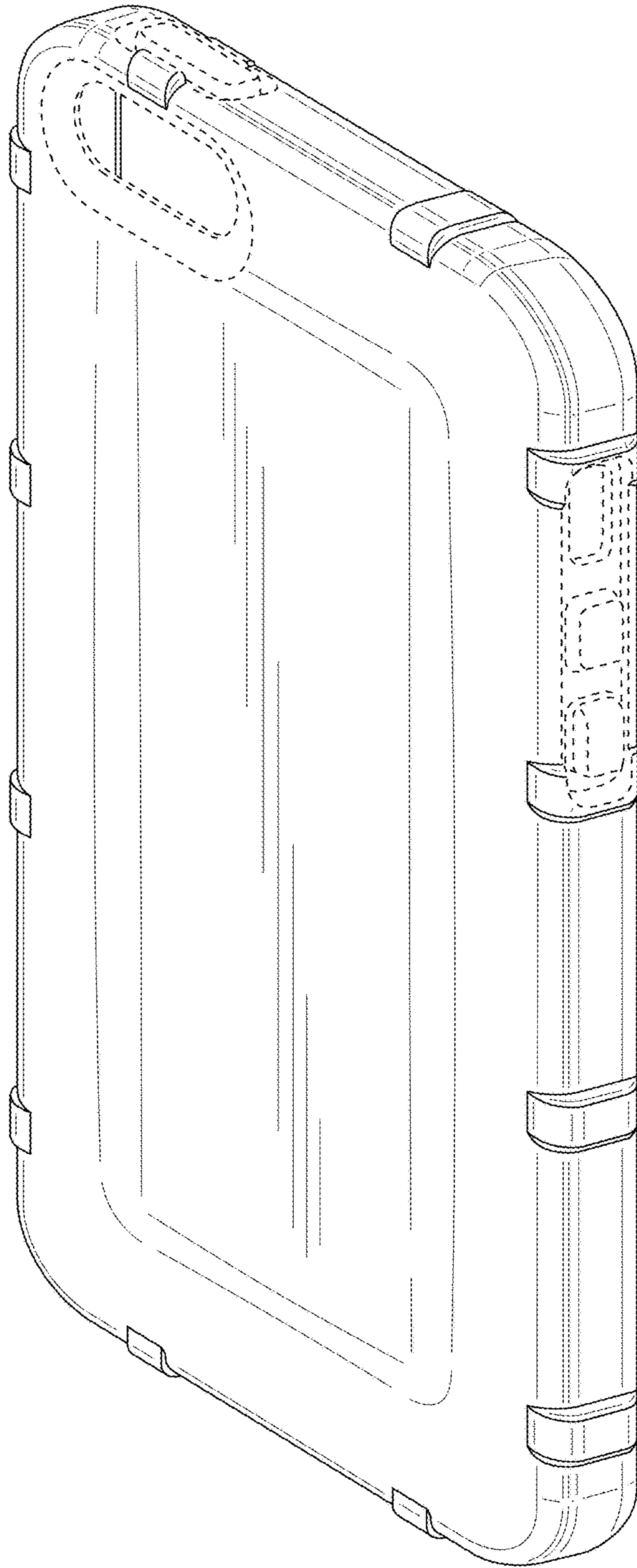

FIG. 3

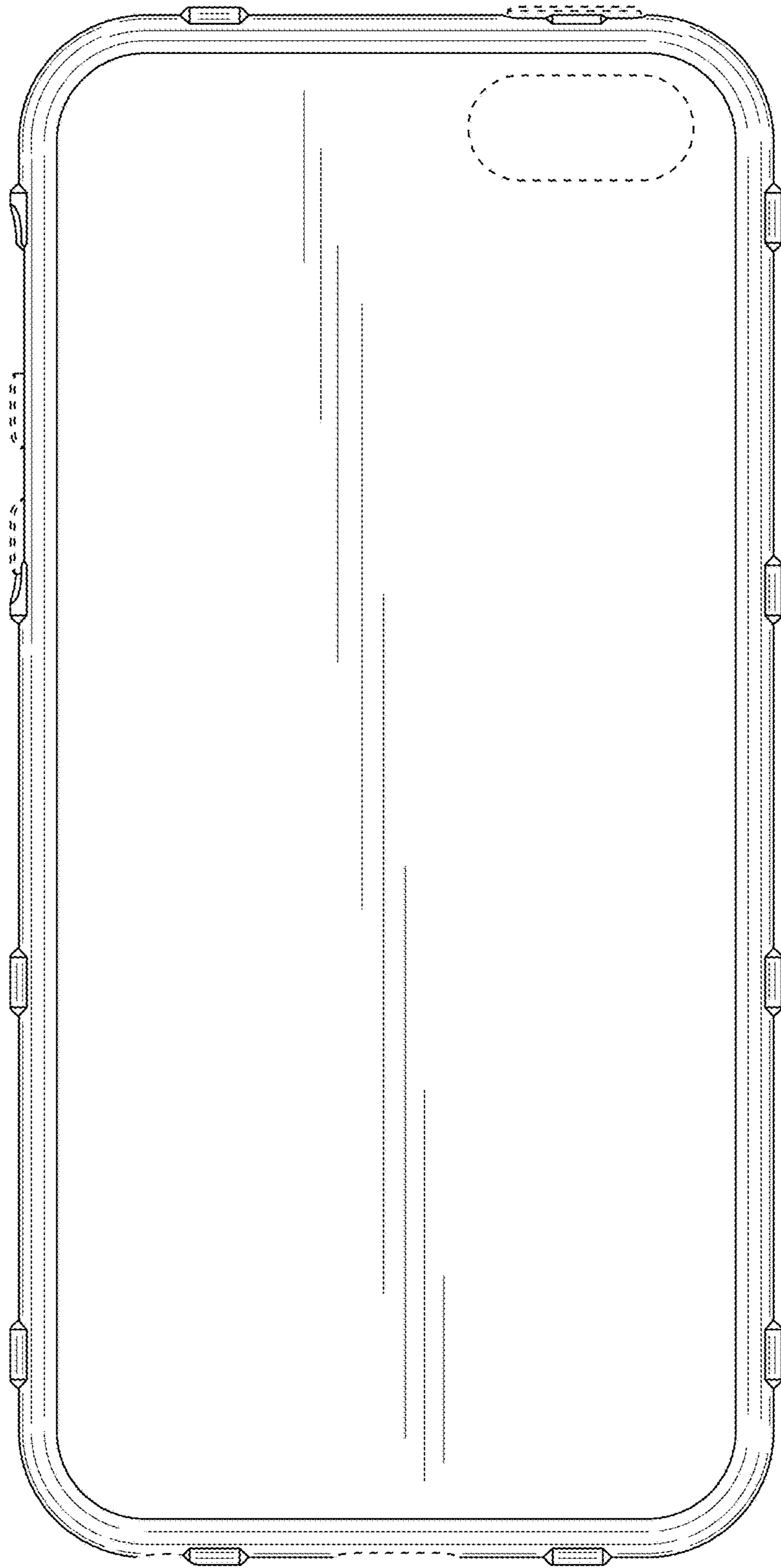

FIG. 4

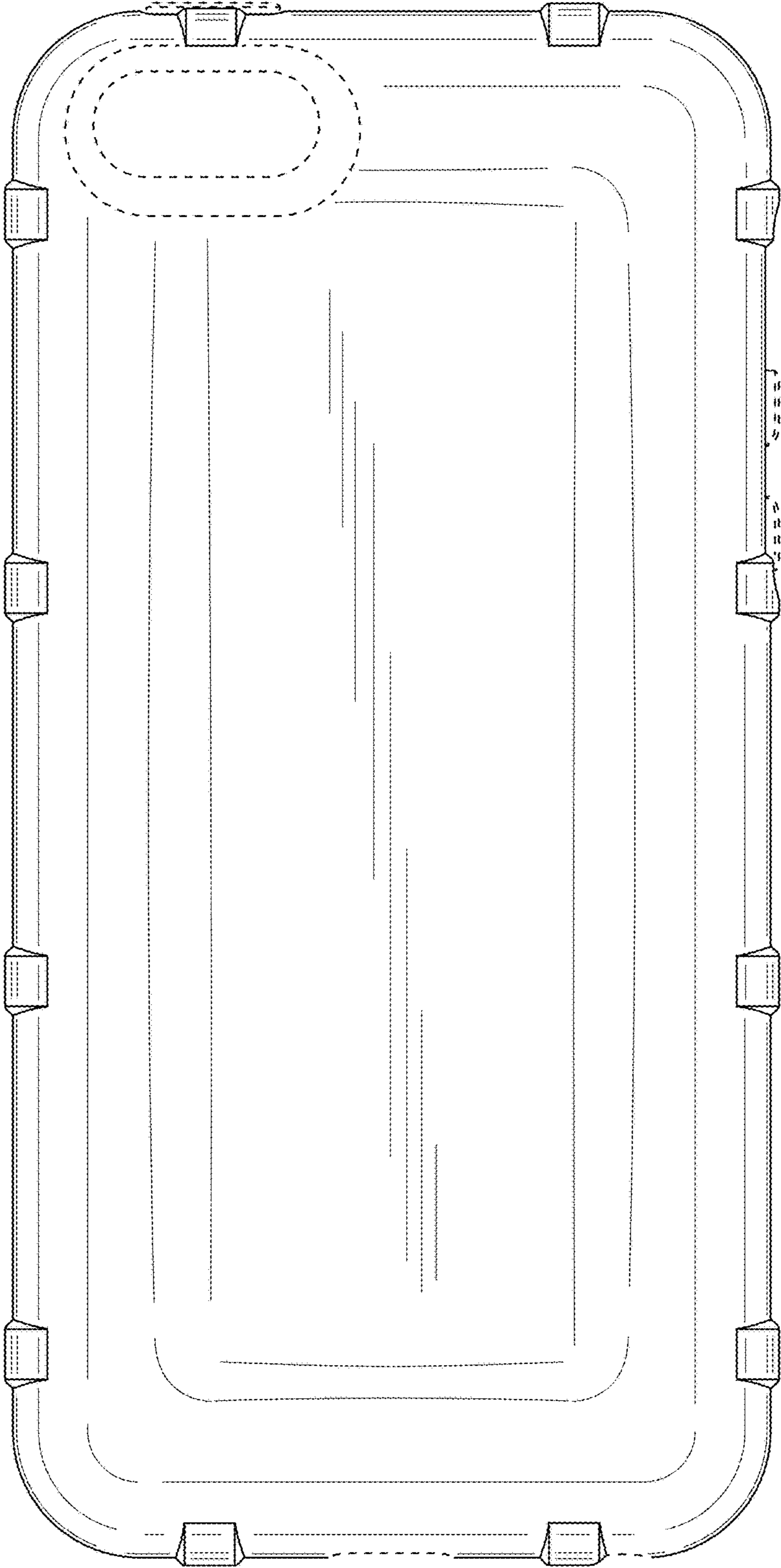

FIG.5

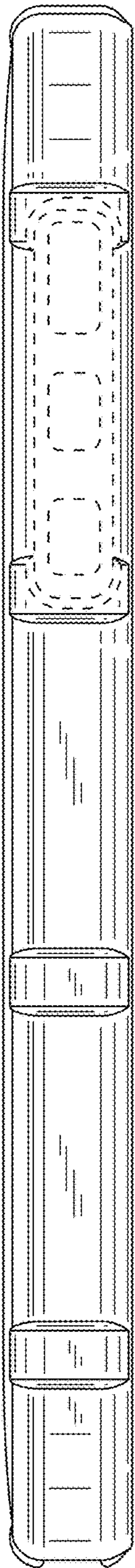

FIG. 6

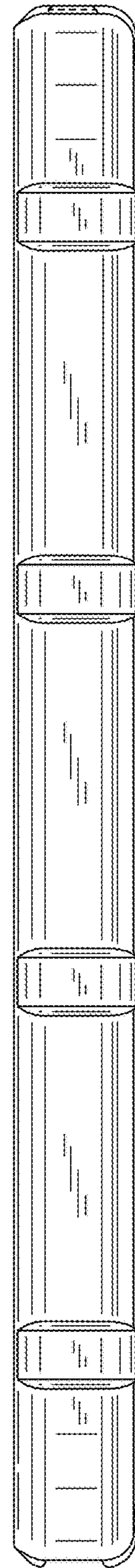

FIG. 7

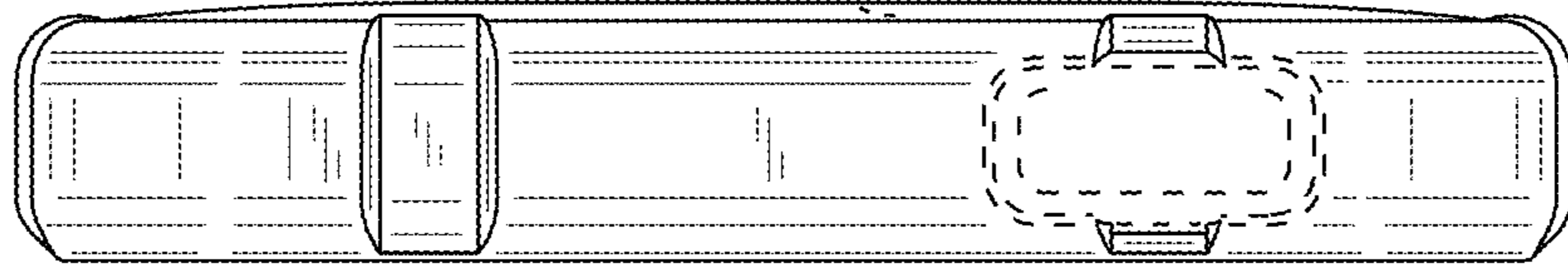

FIG. 8

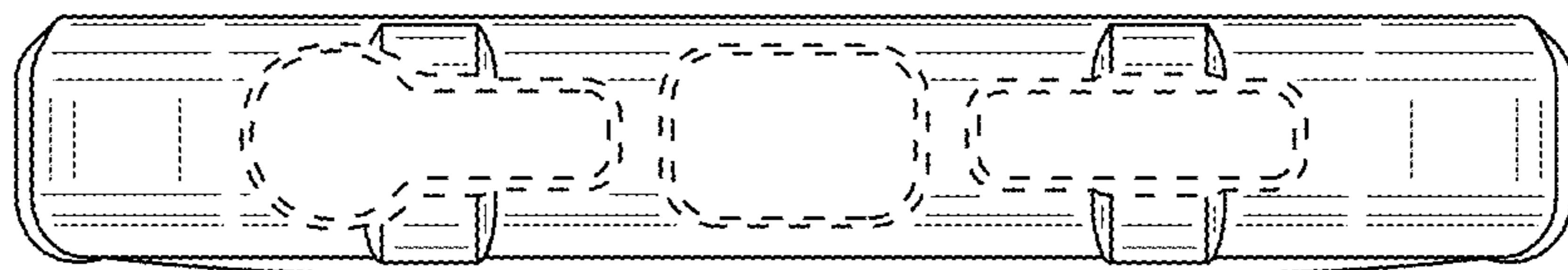

FIG. 9