



US00D780712S

(12) **United States Design Patent**
Poandl

(10) **Patent No.:** **US D780,712 S**
(45) **Date of Patent:** **** Mar. 7, 2017**

(54) **BLUETOOTH CLOCK RADIO WITH
REMOVABLE RECHARGEABLE BATTERY**

D688,228 S * 8/2013 Ryu D14/209.1
D709,856 S * 7/2014 Holzer D14/171
D726,682 S * 4/2015 Kim D14/170

(71) Applicant: **Mary Beth Poandl**, Red Bank, NJ (US)

(72) Inventor: **Mary Beth Poandl**, Red Bank, NJ (US)

(73) Assignee: **SDI TECHNOLOGIES, INC.**,
Rahway, NJ (US)

(**) Term: **15 Years**

(21) Appl. No.: **29/533,242**

(22) Filed: **Jul. 15, 2015**

(51) **LOC (10) Cl.** **14-01**

(52) **U.S. Cl.**
USPC **D14/171**

(58) **Field of Classification Search**
USPC D14/168-171, 188-198; 455/344, 347,
455/350
CPC B60R 1/02; H04B 1/06
See application file for complete search history.

(56) **References Cited**

U.S. PATENT DOCUMENTS

D577,709 S * 9/2008 Skurdal D14/171
D597,064 S * 7/2009 Machida D14/167
D600,251 S * 9/2009 Poandl D14/168
D642,154 S * 7/2011 Poandl D14/171
D648,743 S * 11/2011 Chang D14/168
D677,245 S * 3/2013 Joseph D14/204

OTHER PUBLICATIONS

U.S. Appl. No. 29/509,619, filed Nov. 2014, Poandl.

* cited by examiner

Primary Examiner — Sandra Morris

(74) *Attorney, Agent, or Firm* — Ostrolenk Faber LLP

(57) **CLAIM**

The ornamental design for a bluetooth clock radio with removable rechargeable battery, as shown and described.

DESCRIPTION

FIG. 1 is a front perspective view of a bluetooth clock radio with removable rechargeable battery showing my new design;

FIG. 2 is a front view thereof;

FIG. 3 is a rear view thereof;

FIG. 4 is a left side view thereof;

FIG. 5 is a right side view thereof;

FIG. 6 is a top view thereof;

FIG. 7 is a bottom view thereof; and,

FIG. 8 is a cross-sectional view thereof along line 8-8 in FIG. 2.

The broken lines in the drawings illustrate environmental material that forms no part of the claimed design.

1 Claim, 7 Drawing Sheets

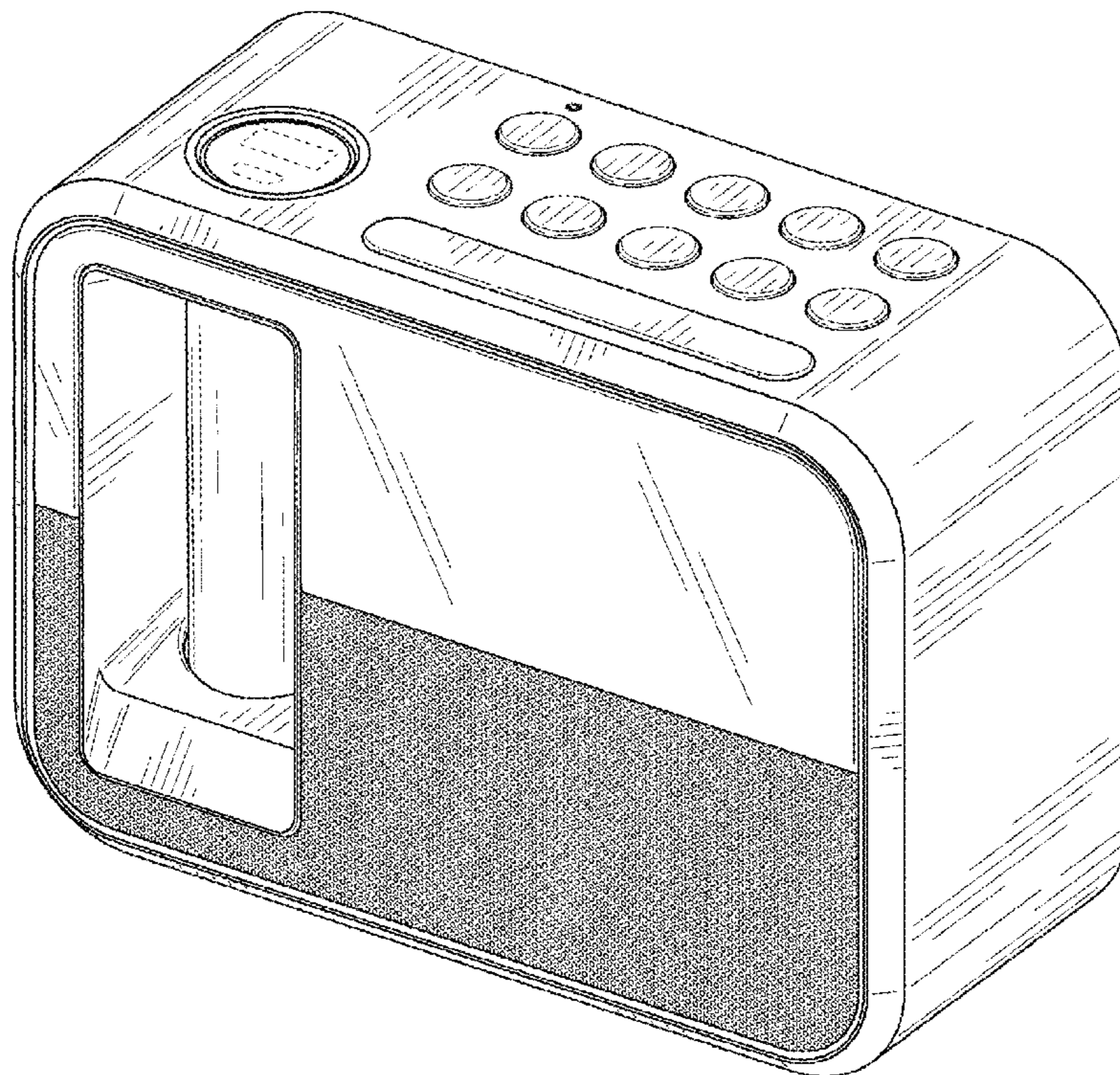

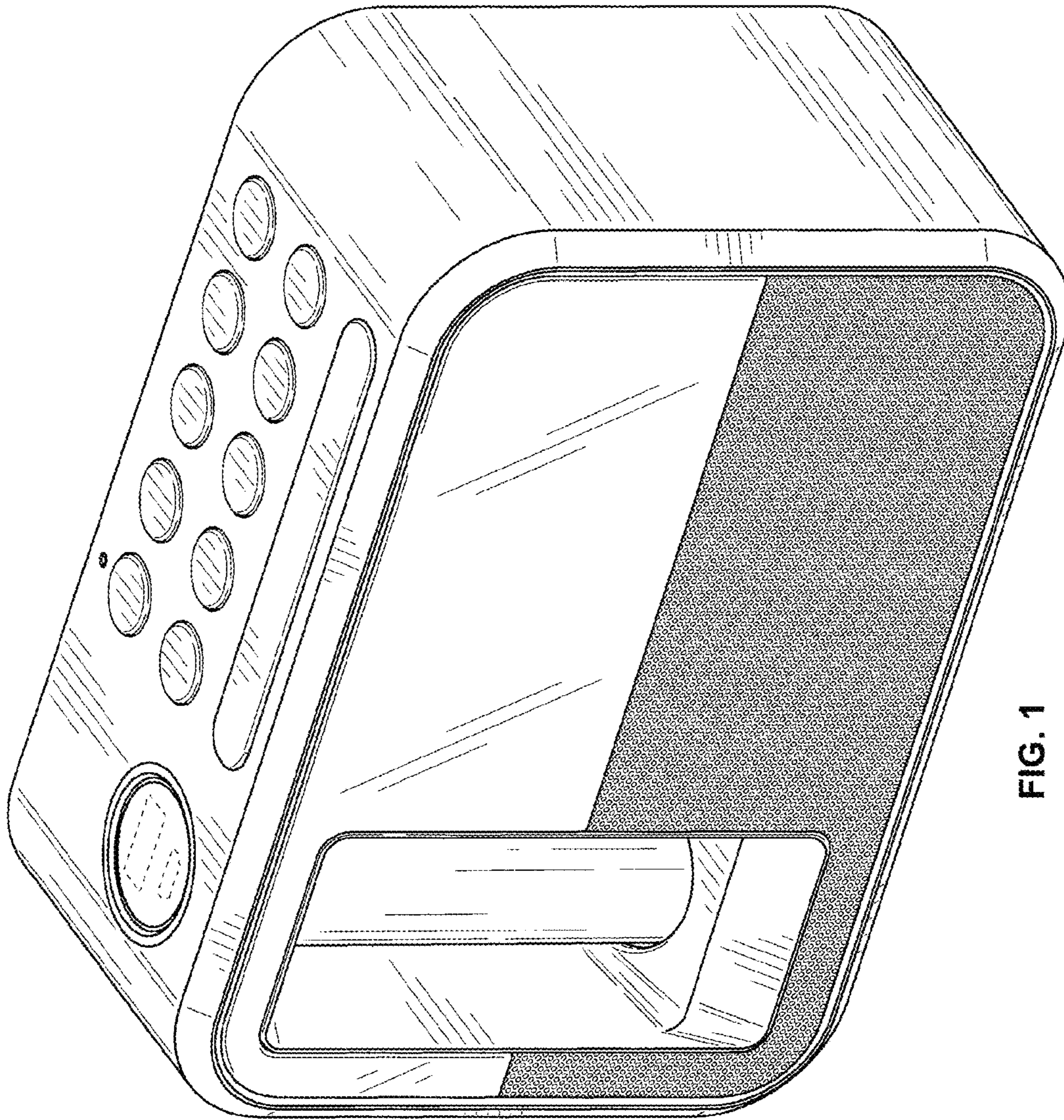

FIG. 1

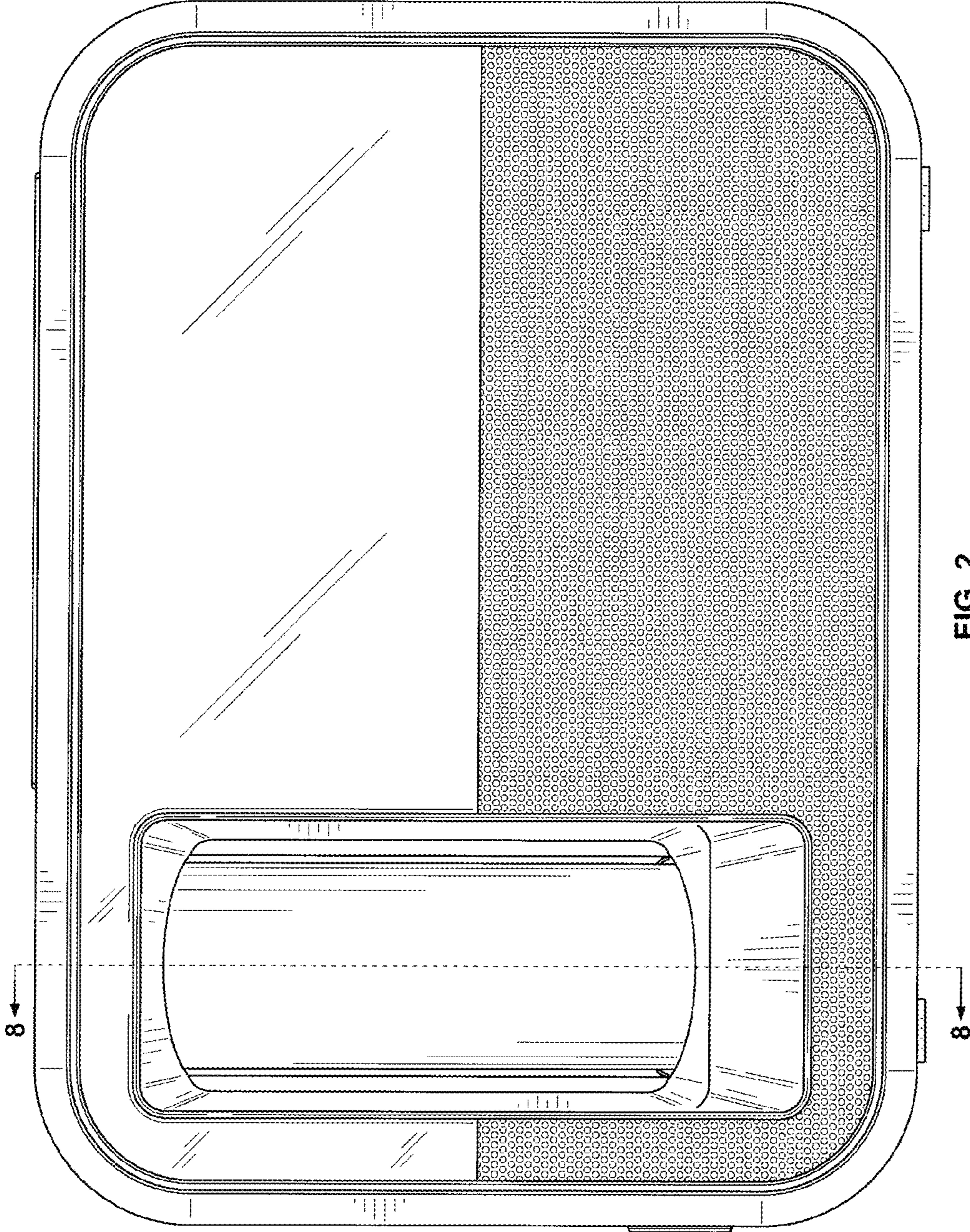

FIG. 2

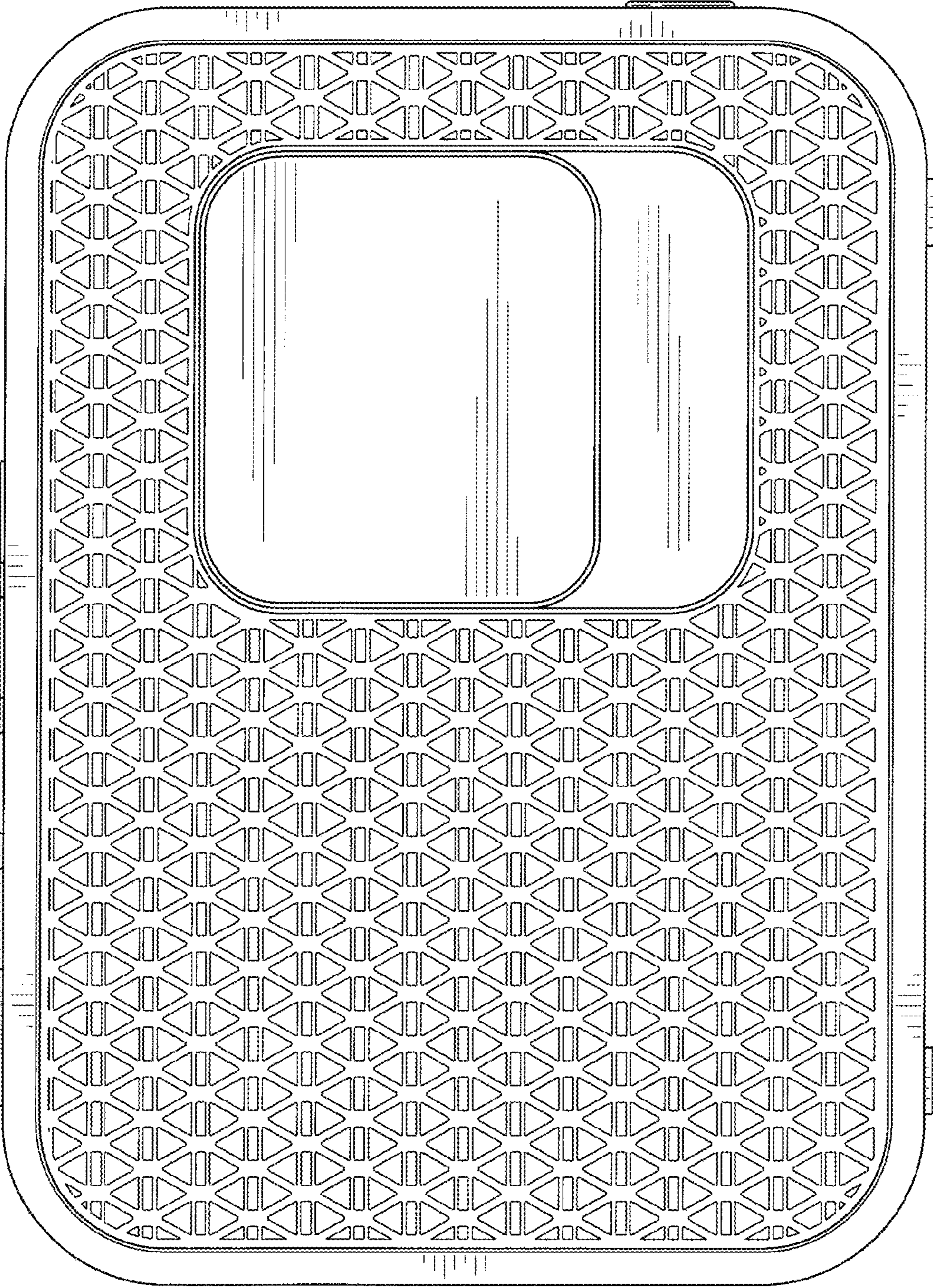

FIG. 3

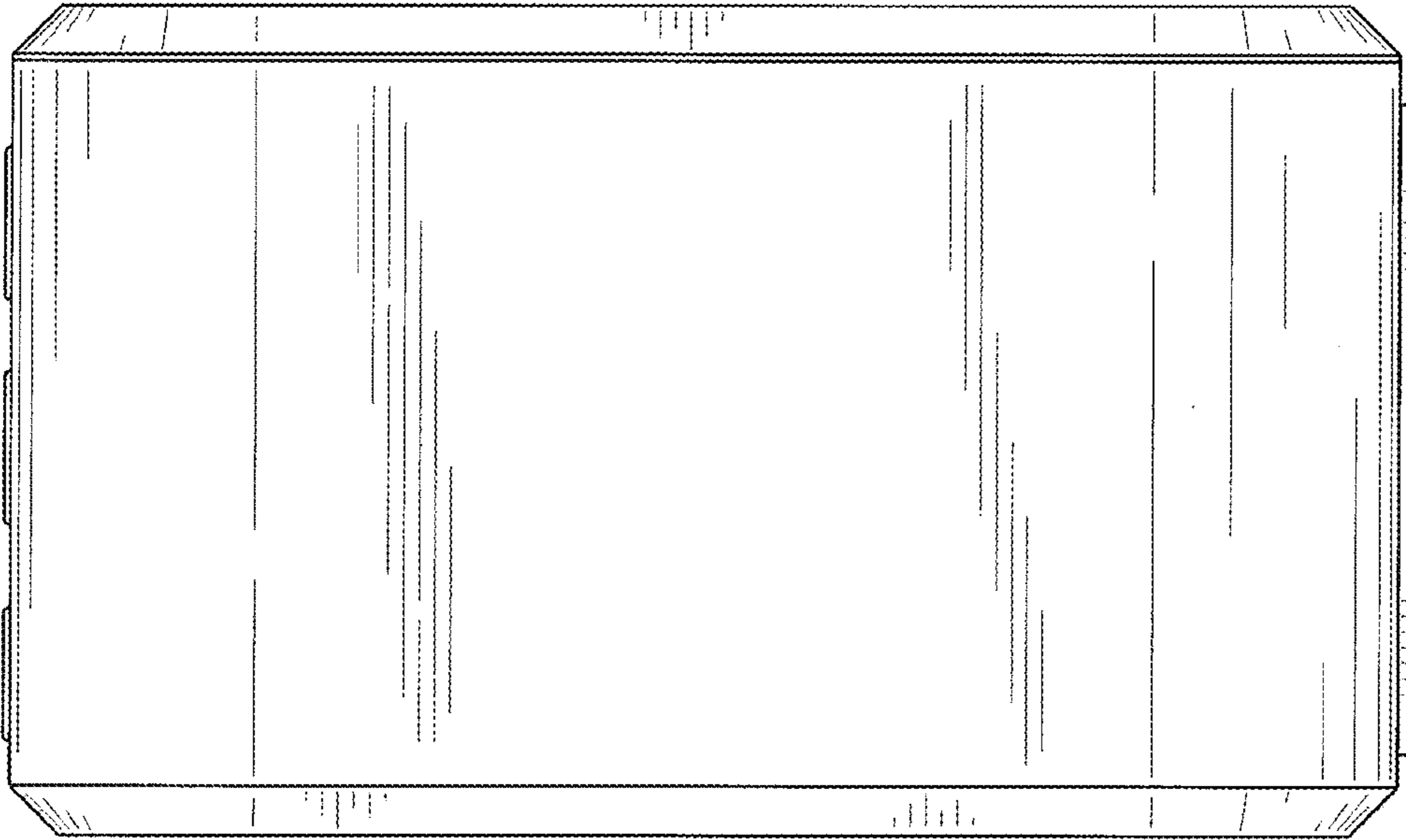

FIG. 5

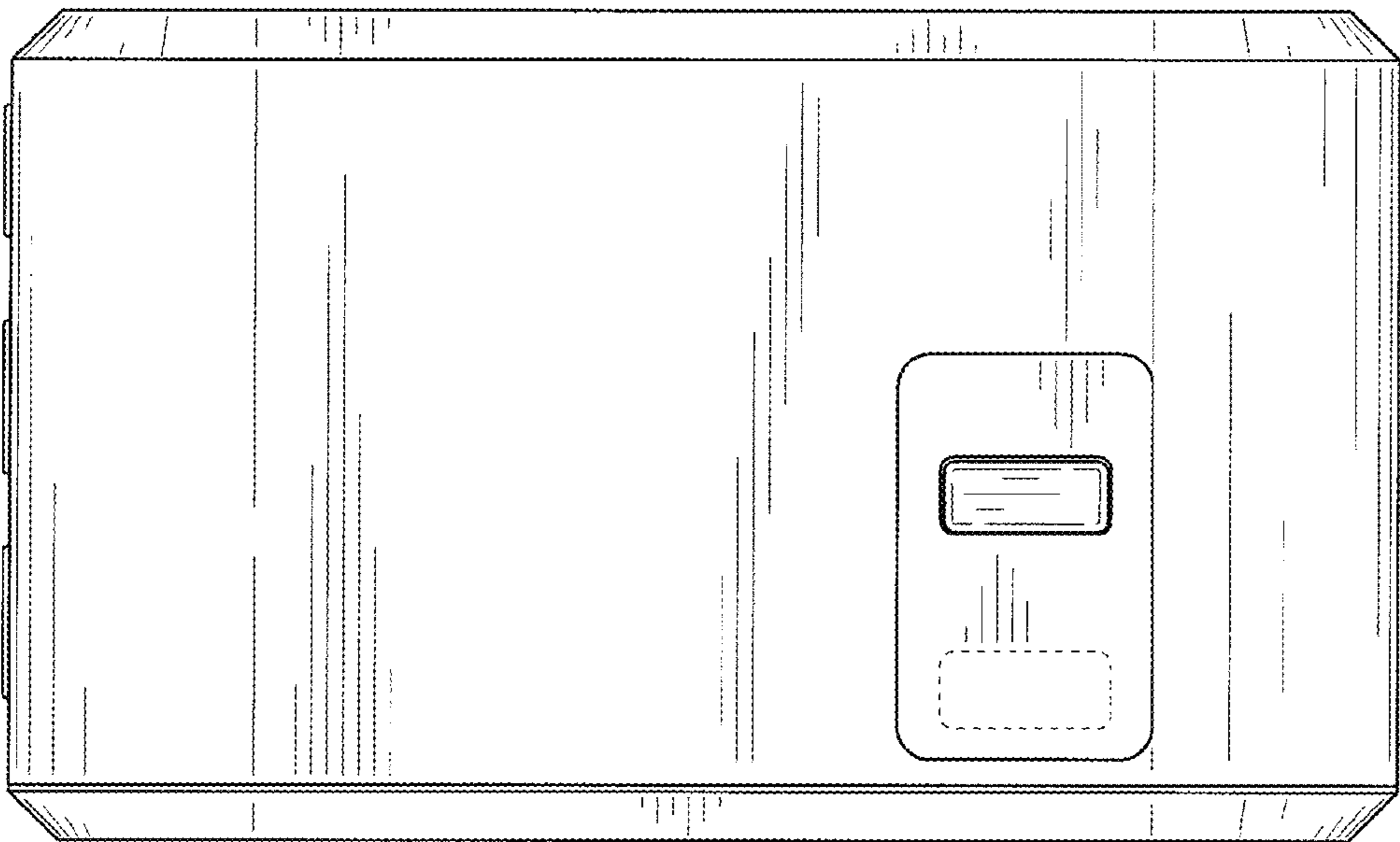

FIG. 4

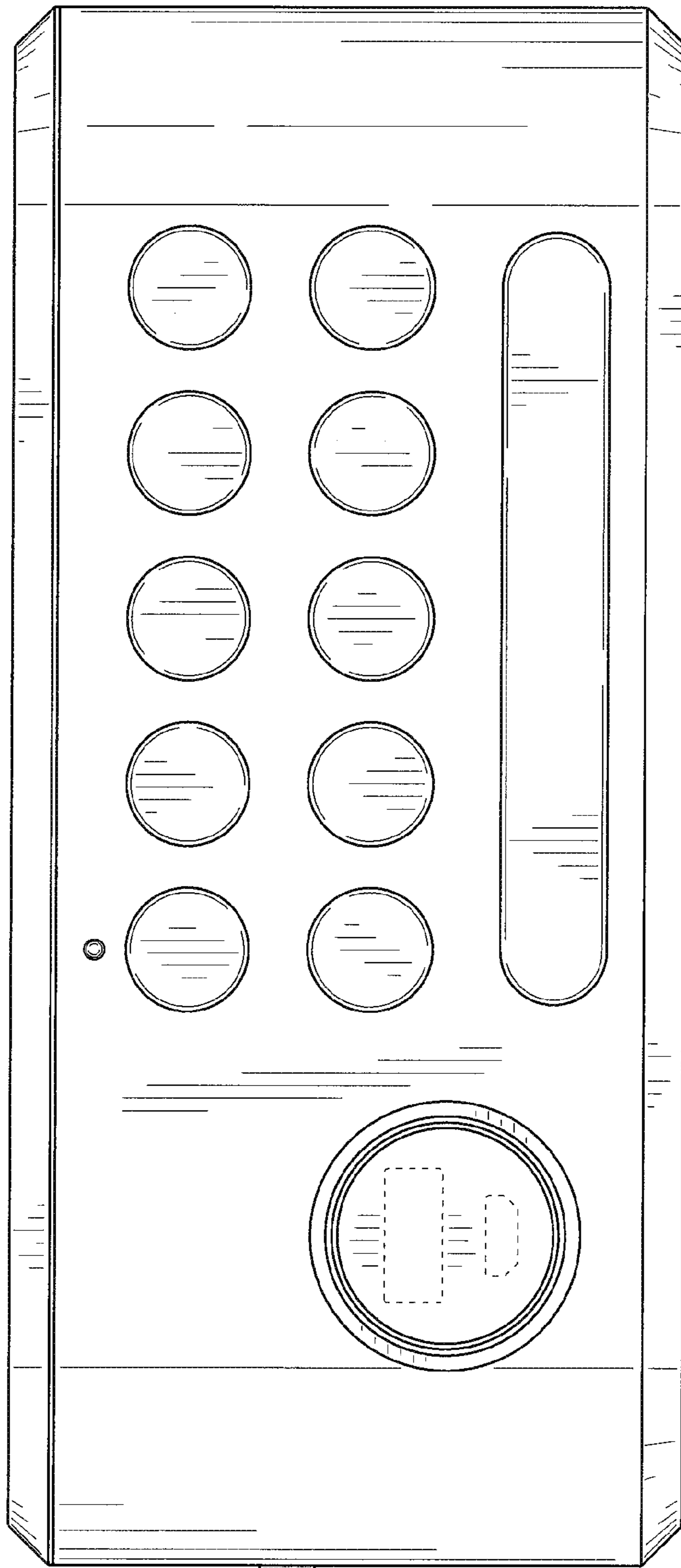

FIG. 6

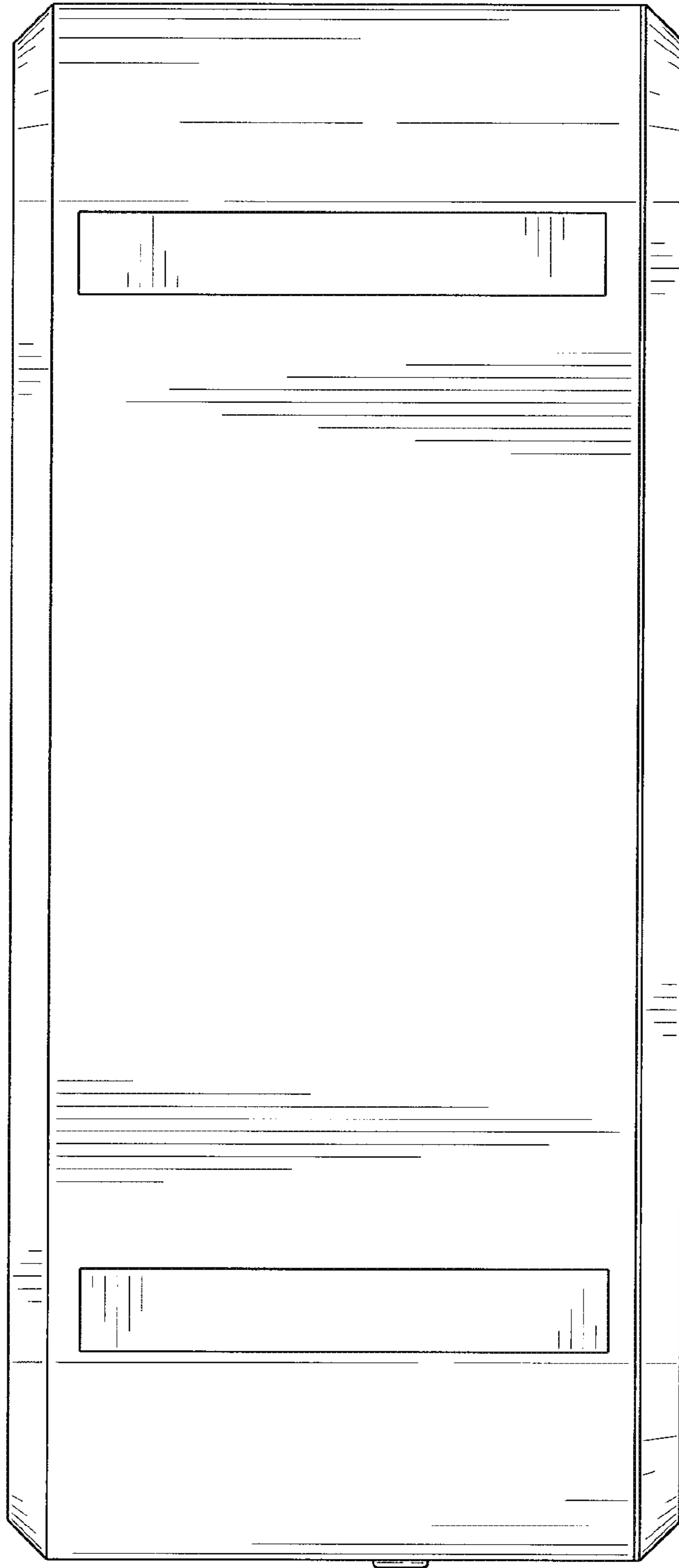

FIG. 7

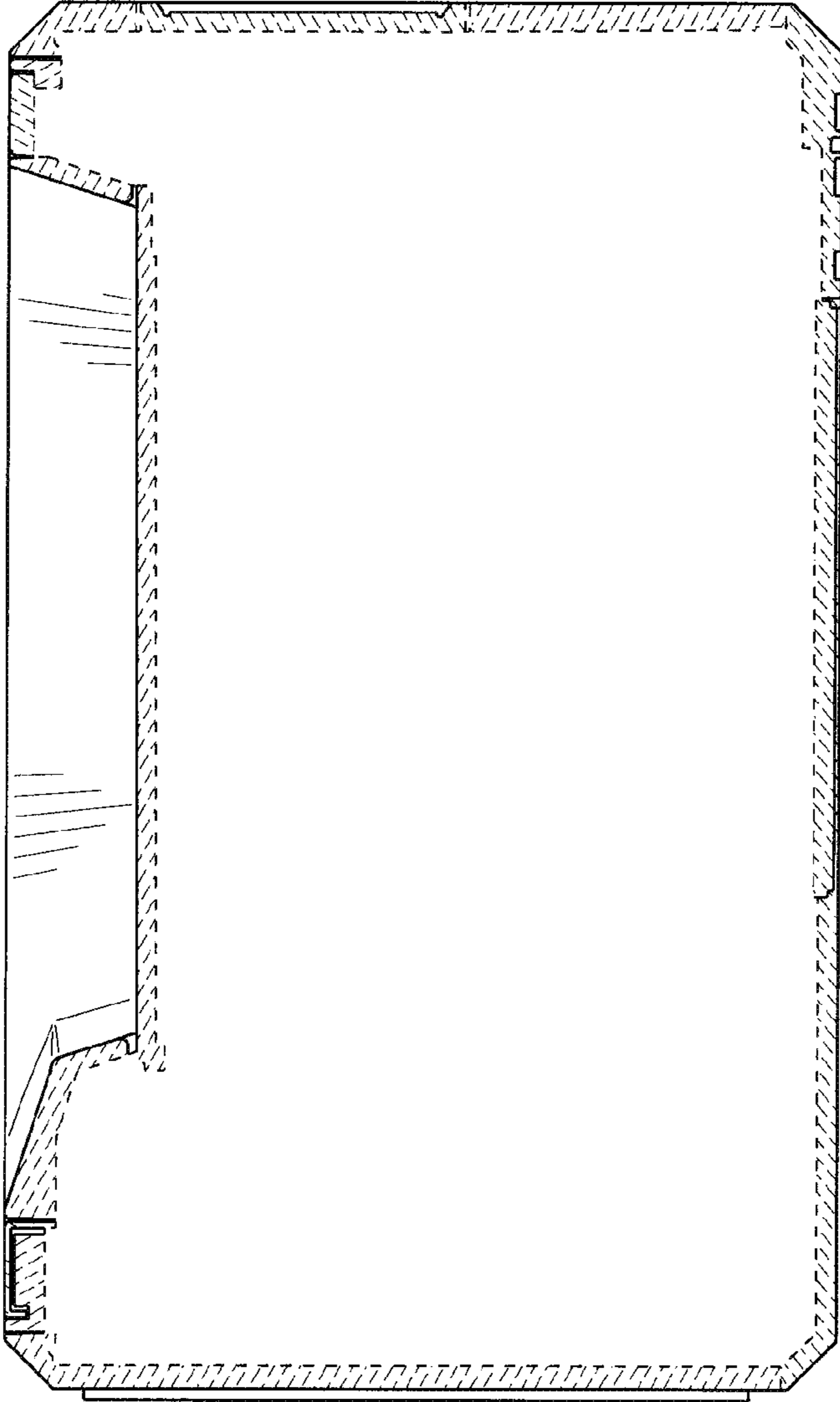

FIG. 8