



US00D780606S

(12) **United States Design Patent**
Osaka et al.

(10) **Patent No.:** **US D780,606 S**
(45) **Date of Patent:** **** Mar. 7, 2017**

(54) **PROTECTOR TUBE FOR THERMOCOUPLE**

(71) Applicant: **Hitachi Kokusai Electric Inc.**, Tokyo (JP)

(72) Inventors: **Akihiro Osaka**, Toyama (JP); **Hideto Yamaguchi**, Toyama (JP); **Moyota Takewaki**, Toyama (JP)

(73) Assignee: **HITACHI KOKUSAI ELECTRIC INC.**, Tokyo (JP)

(**) Term: **15 Years**

(21) Appl. No.: **29/536,746**

(22) Filed: **Aug. 19, 2015**

(30) **Foreign Application Priority Data**

Feb. 25, 2015 (JP) 2015-003915

(51) **LOC (10) Cl.** **10-04**

(52) **U.S. Cl.**
USPC **D10/60**

(58) **Field of Classification Search**

USPC D10/49, 50, 51, 52, 53, 54, 55, 56, 60
CPC G01K 7/02; G01K 7/021; G01K 7/023;
G01K 7/025; G01K 7/026; G01K 7/028;
G01K 7/04; G01K 7/06; G01K
7/08; G01K 7/10; G01K 7/12; G01K 7/13;
G01K 7/14; G01K 1/12; G01K
1/08; G01K 1/125; G01K 1/10; G01K
1/105

See application file for complete search history.

(56) **References Cited**

U.S. PATENT DOCUMENTS

4,088,509 A * 5/1978 Blaze, Jr. G01K 1/08
136/230
4,663,205 A * 5/1987 Hayashi G01K 1/08
136/230

4,975,123 A * 12/1990 Gray G01K 7/04
136/230
6,776,524 B2 * 8/2004 Park G01K 7/02
374/148
6,857,776 B2 * 2/2005 Park G01K 7/02
136/230
D597,423 S * 8/2009 Park D10/52

* cited by examiner

Primary Examiner — Antoine D Davis

(74) *Attorney, Agent, or Firm* — Fitch, Even, Tabin & Flannery, LLP

(57) **CLAIM**

We claim the ornamental design for a protector tube for thermocouple, as shown (and described).

DESCRIPTION

FIG. 1 is a perspective view of a protector tube for thermocouple showing my new design;
FIG. 2 is a front elevational view thereof;
FIG. 3 is a rear elevational view thereof;
FIG. 4 is a left side elevational view thereof;
FIG. 5 is a right side elevational view thereof;
FIG. 6 is a top plan view thereof; and
FIG. 7 is a bottom plan view thereof.
FIG. 8 is a cross-sectional view taken along line 8-8 in FIG. 6 thereof;
FIG. 9 is an enlarged cross-sectional view taken along line 9-9 in FIG. 8 thereof; and,
FIG. 10 is an enlarged cross-sectional view taken along line 10-10 in FIG. 2 thereof.

1 Claim, 4 Drawing Sheets

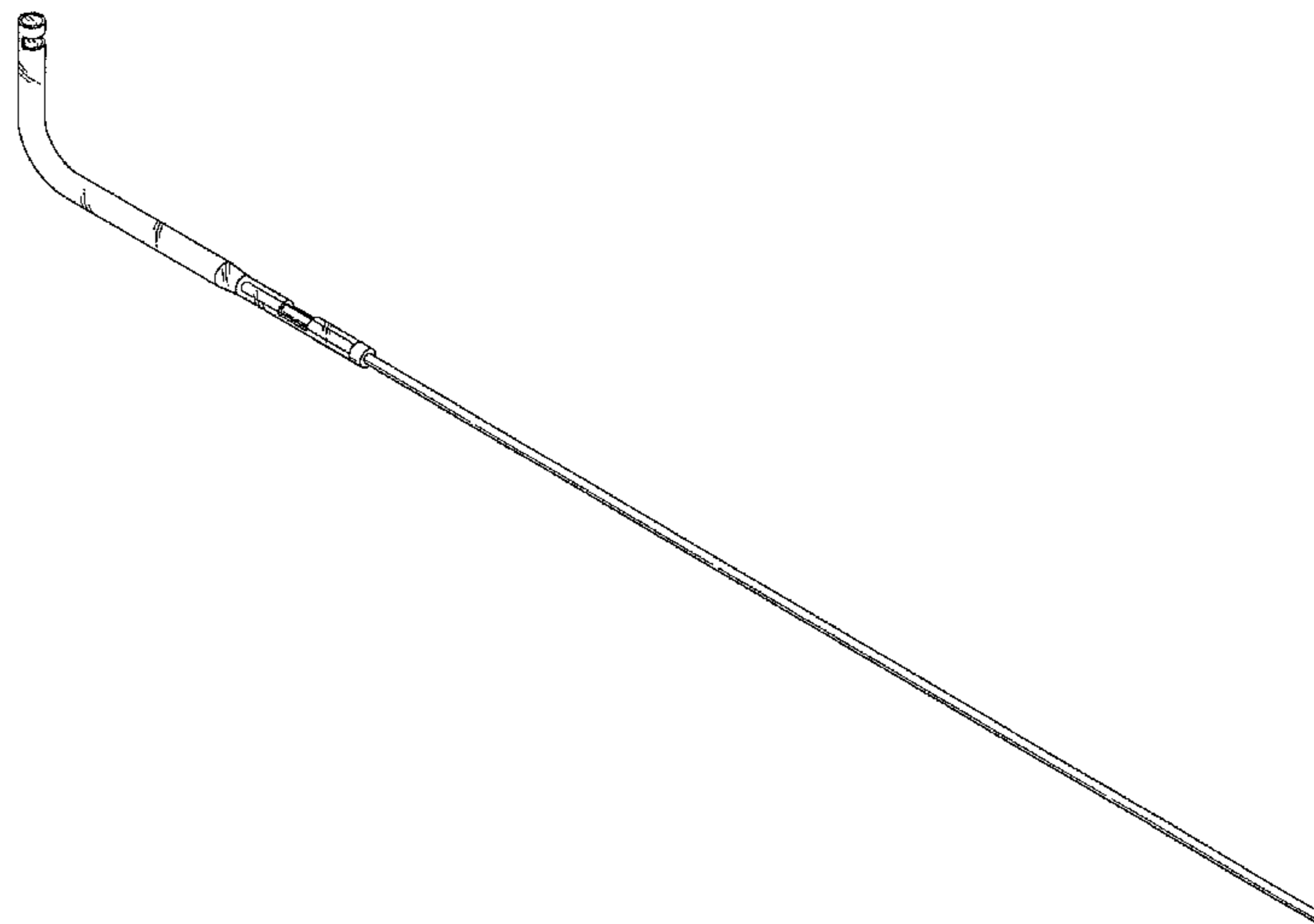



FIG. 1

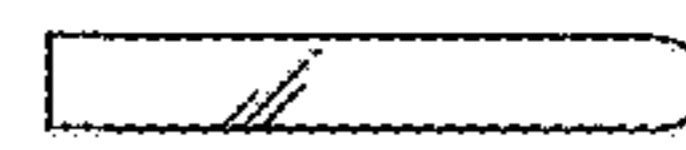
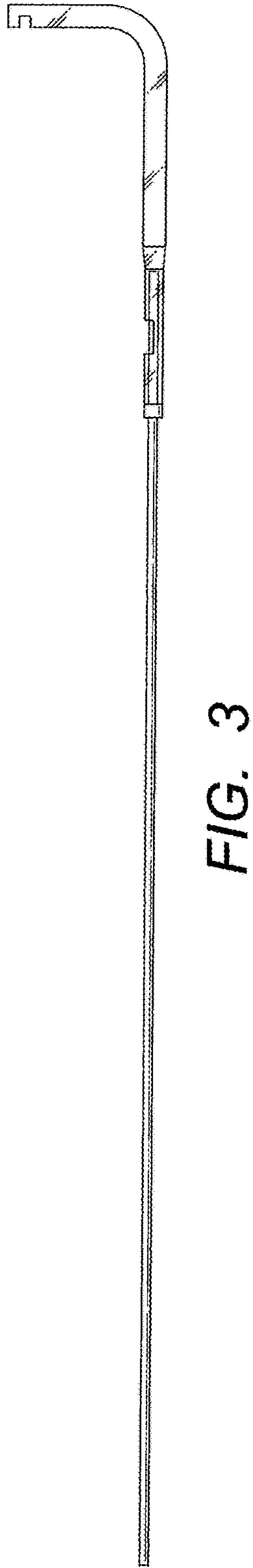
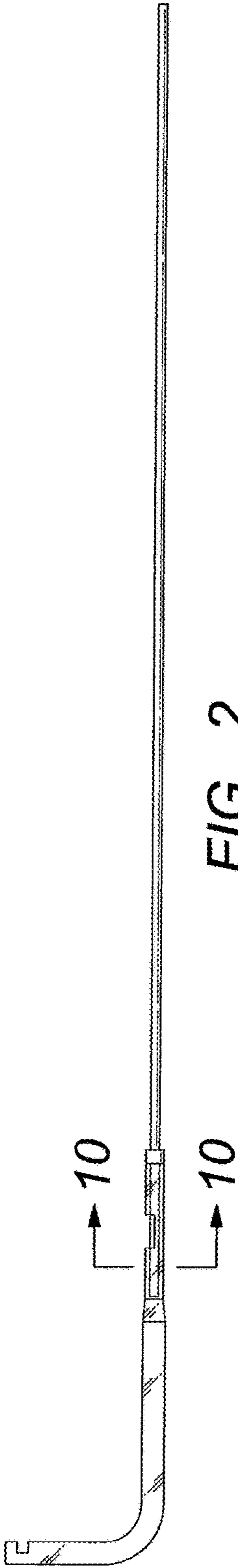

FIG. 4

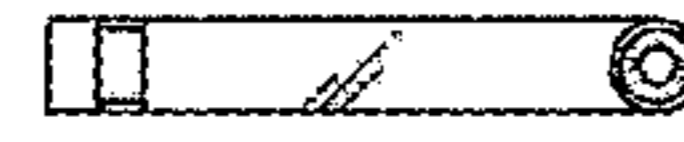

FIG. 5

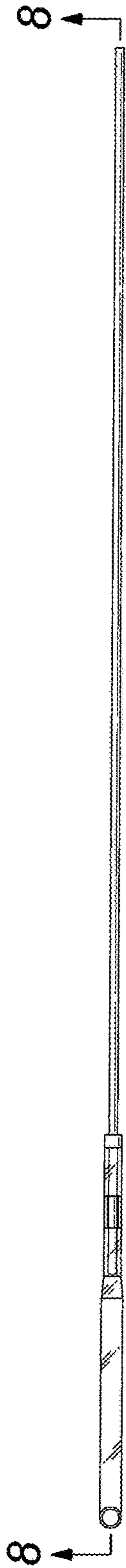

FIG. 6



FIG. 7

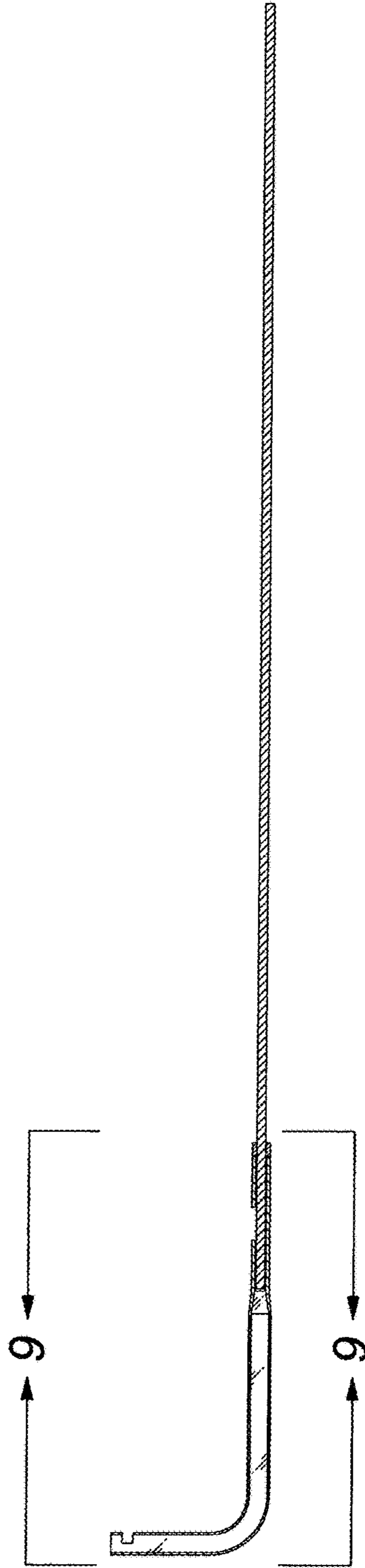

FIG. 8

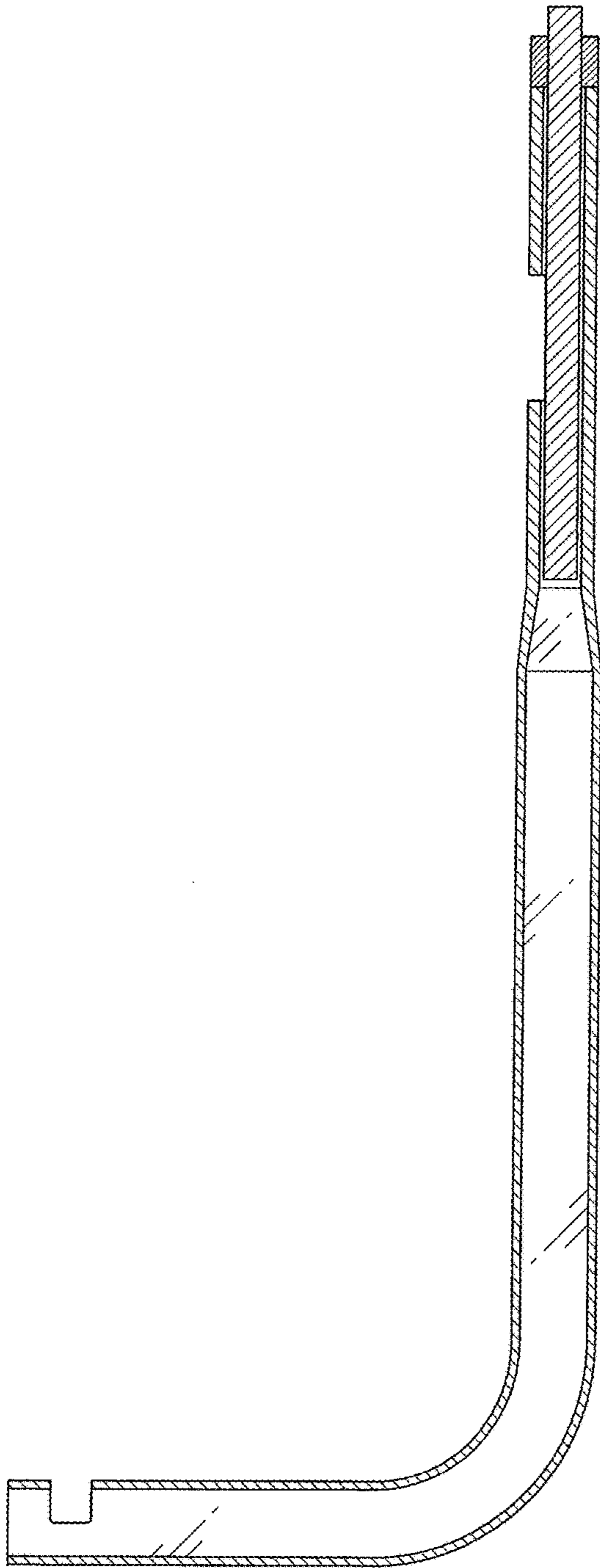

FIG. 9

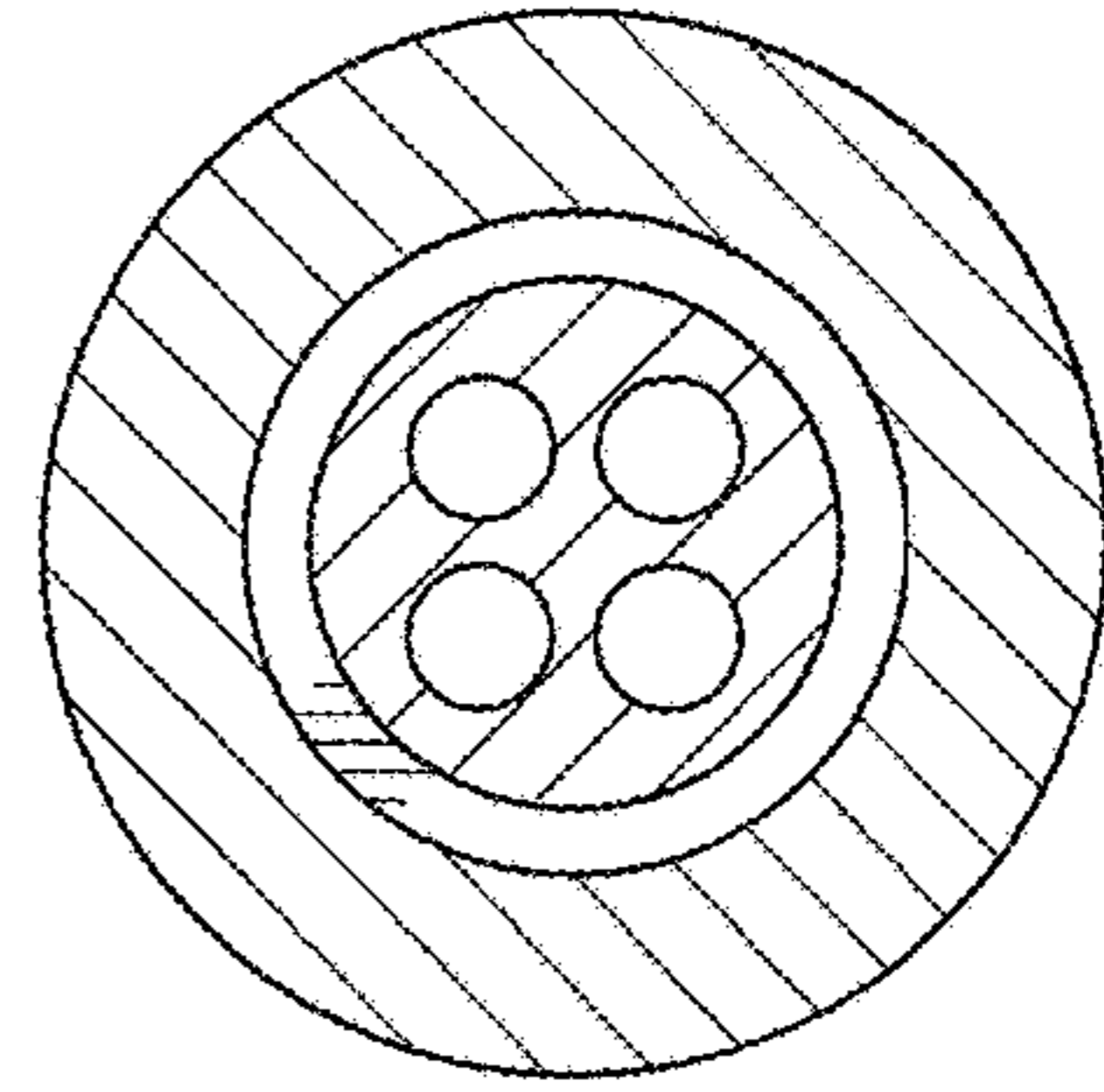

FIG. 10