

US00D780492S

(12) **United States Design Patent**
Terada

(10) **Patent No.:** **US D780,492 S**
(45) **Date of Patent:** **** Mar. 7, 2017**

(54) **TABLE**

(71) Applicants: **ITOKI CORPORATION**, Osaka-shi,
Osaka (JP); **Inter Office Ltd.**, Tokyo
(JP)

(72) Inventor: **Naoki Terada**, Tokyo (JP)

(73) Assignees: **ITOKI CORPORATION**, Osaka-shi,
Osaka (JP); **INTER OFFICE LTD.**,
Tokyo (JP)

(**) Term: **15 Years**

(21) Appl. No.: **29/547,061**

(22) Filed: **Dec. 1, 2015**

(30) **Foreign Application Priority Data**

Jun. 2, 2015 (JP) 2015-012216

(51) **LOC (10) Cl.** **06-04**

(52) **U.S. Cl.**
USPC **D6/692; D6/692.4; D6/349**

(58) **Field of Classification Search**
USPC D6/334, 335, 349, 692, 692.4, 707.6;
297/16.142

CPC .. A47B 7/00; A47B 11/00; A47C 1/00; A47C
4/00

See application file for complete search history.

(56) **References Cited**

U.S. PATENT DOCUMENTS

D145,947 S * 11/1946 Larson 108/161
D149,524 S * 5/1948 Sundberg D6/691.6
D149,525 S * 5/1948 Sundberg 15/DIG. 10
D182,024 S * 2/1958 Greenberg 297/461
D210,606 S * 3/1968 Hamilton et al. D6/691.6
3,401,653 A * 9/1968 Knoblock A47B 3/02
108/124

D235,823 S * 7/1975 Hodge D6/696.3
D246,341 S * 11/1977 Boughton D6/692.4
D258,103 S * 2/1981 Baker D6/692
D263,908 S * 4/1982 Imber D6/692.4
D277,250 S * 1/1985 Bernard D6/691.6
D314,878 S * 2/1991 Hart D6/691.3
D361,230 S * 8/1995 Vignelli D6/685
D366,772 S * 2/1996 Pasin D6/349
D388,638 S * 1/1998 Ludlam D6/692
D462,185 S * 9/2002 Sandy D6/349
D535,828 S * 1/2007 Gasca Burges D6/349
D586,573 S * 2/2009 Saitou D6/349
D598,677 S * 8/2009 Fineberg D6/692.3
D611,737 S * 3/2010 Miller D6/692
7,845,717 B2 * 12/2010 Leng A47C 3/40
297/16.1
D644,455 S * 9/2011 Wilson D6/644
D644,457 S * 9/2011 Wilson D6/644

(Continued)

Primary Examiner — Caron D Veynar

Assistant Examiner — Mehri Bajoul

(74) *Attorney, Agent, or Firm* — Drinker Biddle & Reath
LLP

(57) **CLAIM**

The ornamental design for a table, as shown and described.

DESCRIPTION

FIG. 1 is a perspective view of the top, front and right side of a table showing my new design;
FIG. 2 is a perspective view of the top, rear and left side thereof;
FIG. 3 is a front view thereof;
FIG. 4 is a rear view thereof;
FIG. 5 is a left side view thereof;
FIG. 6 is a right side view thereof;
FIG. 7 is a top view thereof; and,
FIG. 8 is a bottom view thereof.

1 Claim, 8 Drawing Sheets

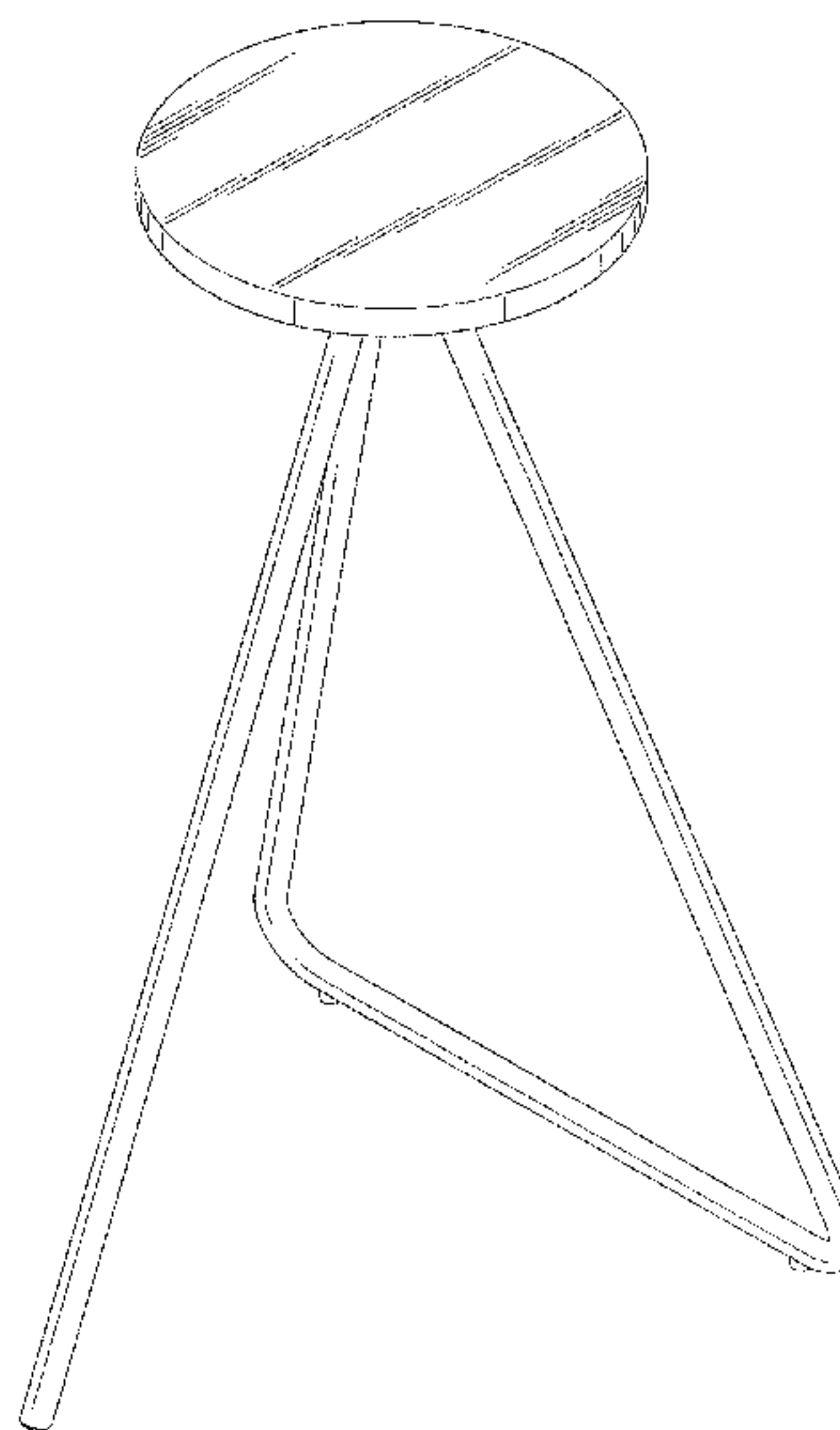
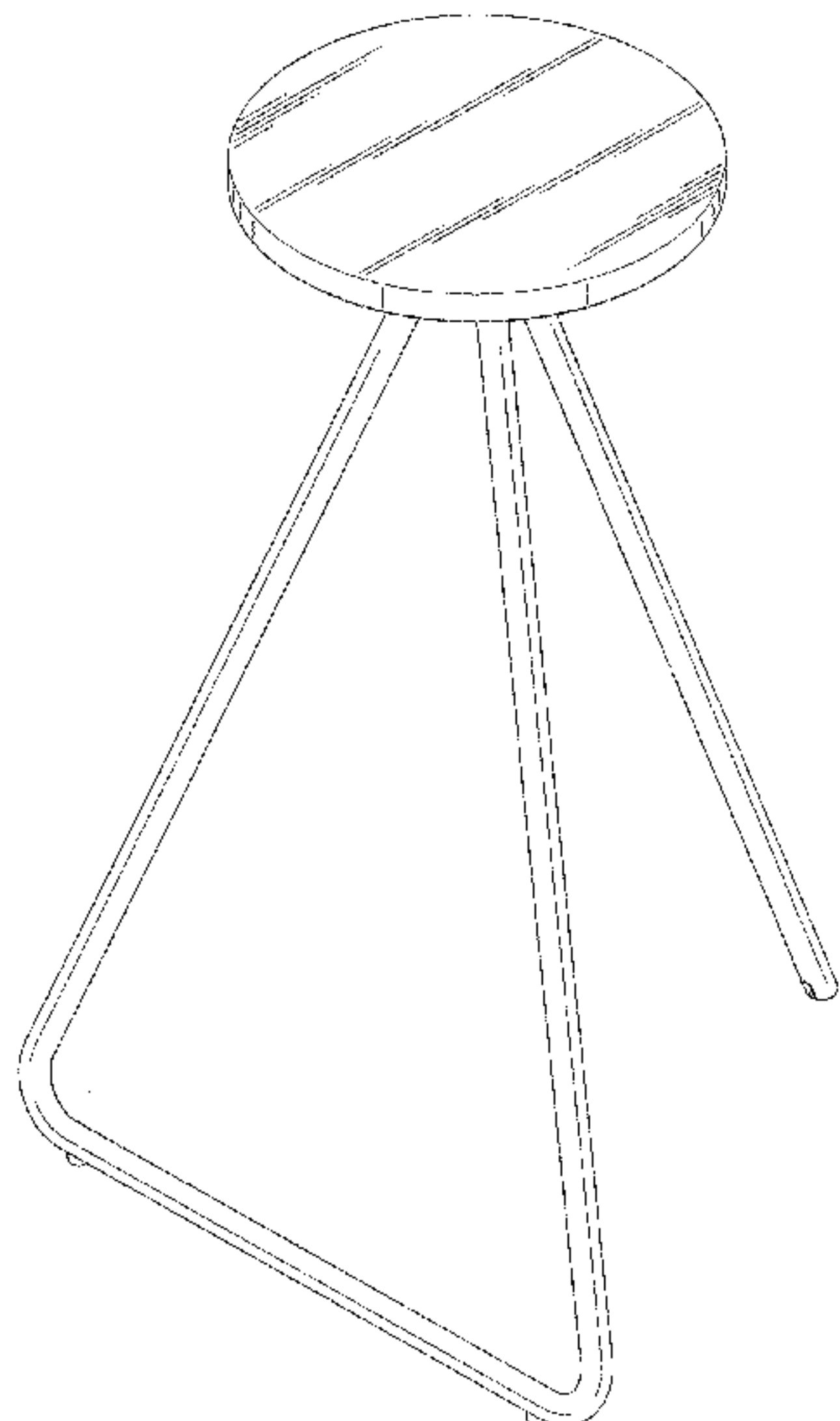

(56)

References Cited

U.S. PATENT DOCUMENTS

D664,371	S	*	7/2012	Wilson	D6/349
D670,926	S	*	11/2012	Ukmar	D6/349
D693,136	S	*	11/2013	Lee	D6/349
D695,051	S	*	12/2013	Perez	D6/354
D696,883	S	*	1/2014	Krusin	D6/692.3
D697,328	S	*	1/2014	Keen	D6/353
D706,045	S	*	6/2014	Cohen	D6/349
D720,143	S	*	12/2014	Barber	D6/349
D720,161	S	*	12/2014	Udagawa	D6/656.13
D720,169	S	*	12/2014	Lenhart	D6/708.16
D720,948	S	*	1/2015	Gonzalez	D6/656.13
D731,216	S	*	6/2015	Sorel	D6/690
D737,750	S	*	9/2015	Garrett	D12/426.1
D746,153	S	*	12/2015	Nishikawa	D9/708
D747,904	S	*	1/2016	Haynes	D6/692
D759,412	S	*	6/2016	Koning	D6/709
D759,994	S	*	6/2016	Lin	D6/656.13
D766,635	S	*	9/2016	Muller	D6/708.17
2007/0187997	A1	*	8/2007	Smith	A47C 4/20 297/16.1

* cited by examiner

Fig. 1

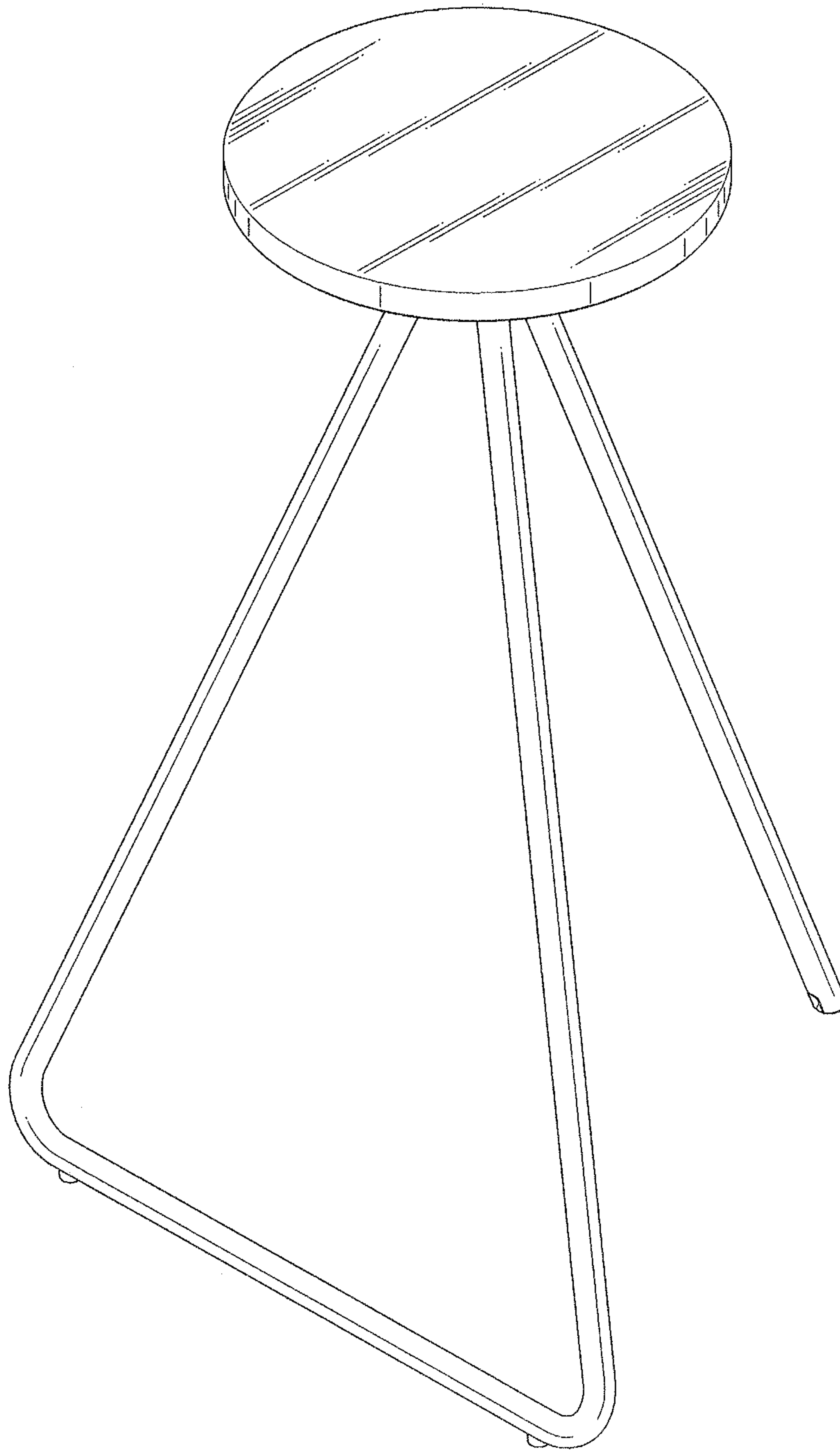

Fig. 2

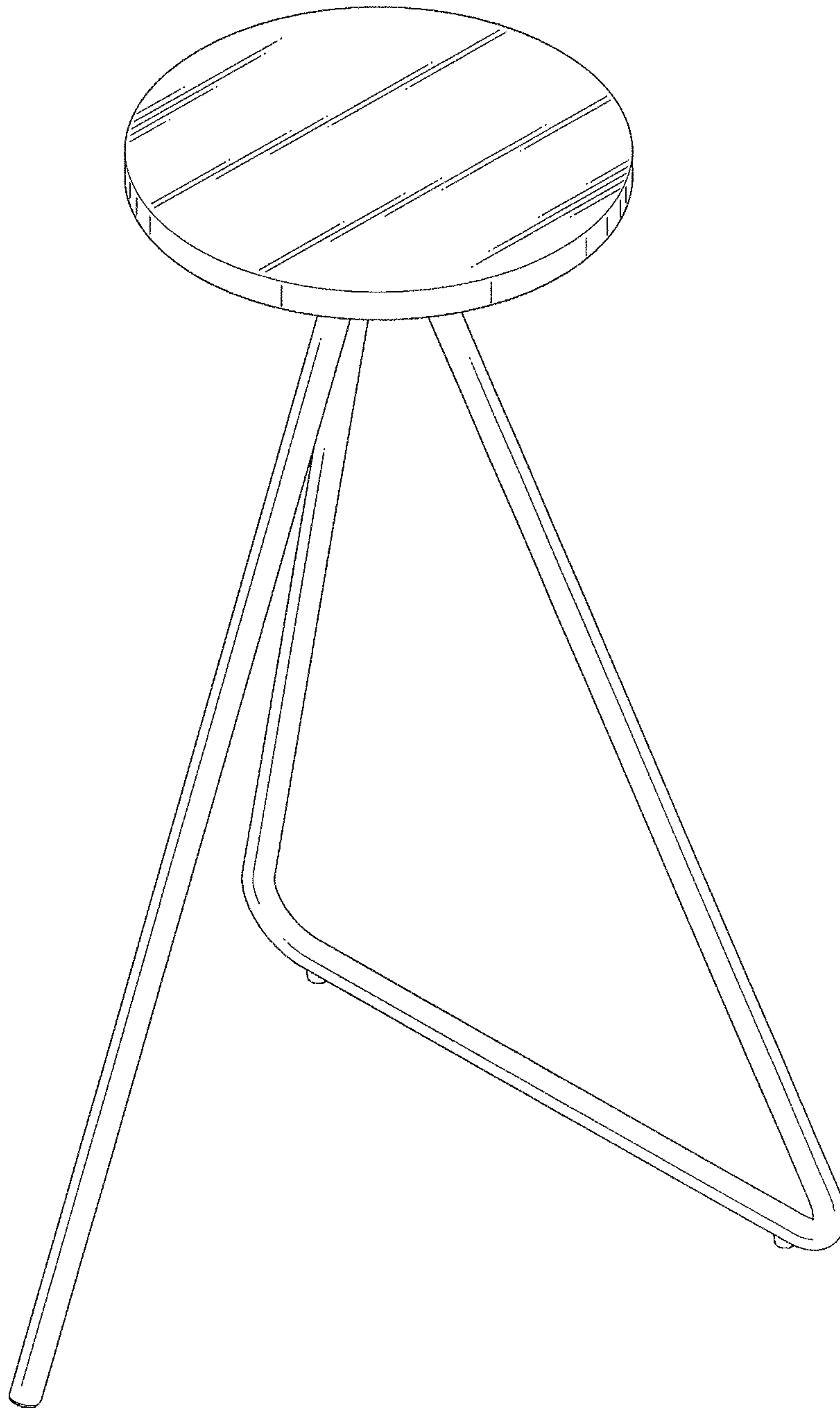

Fig. 3

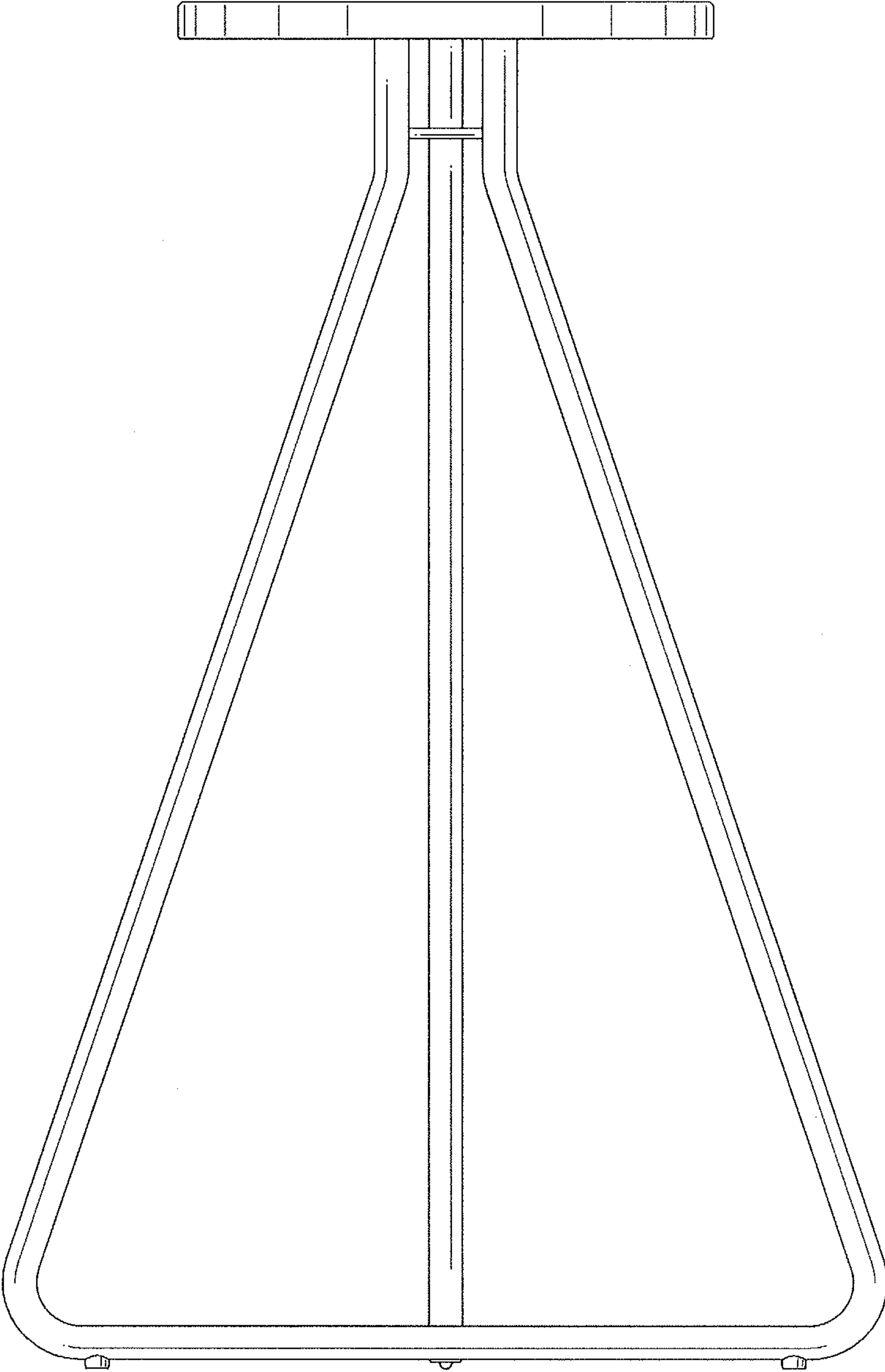

Fig. 4

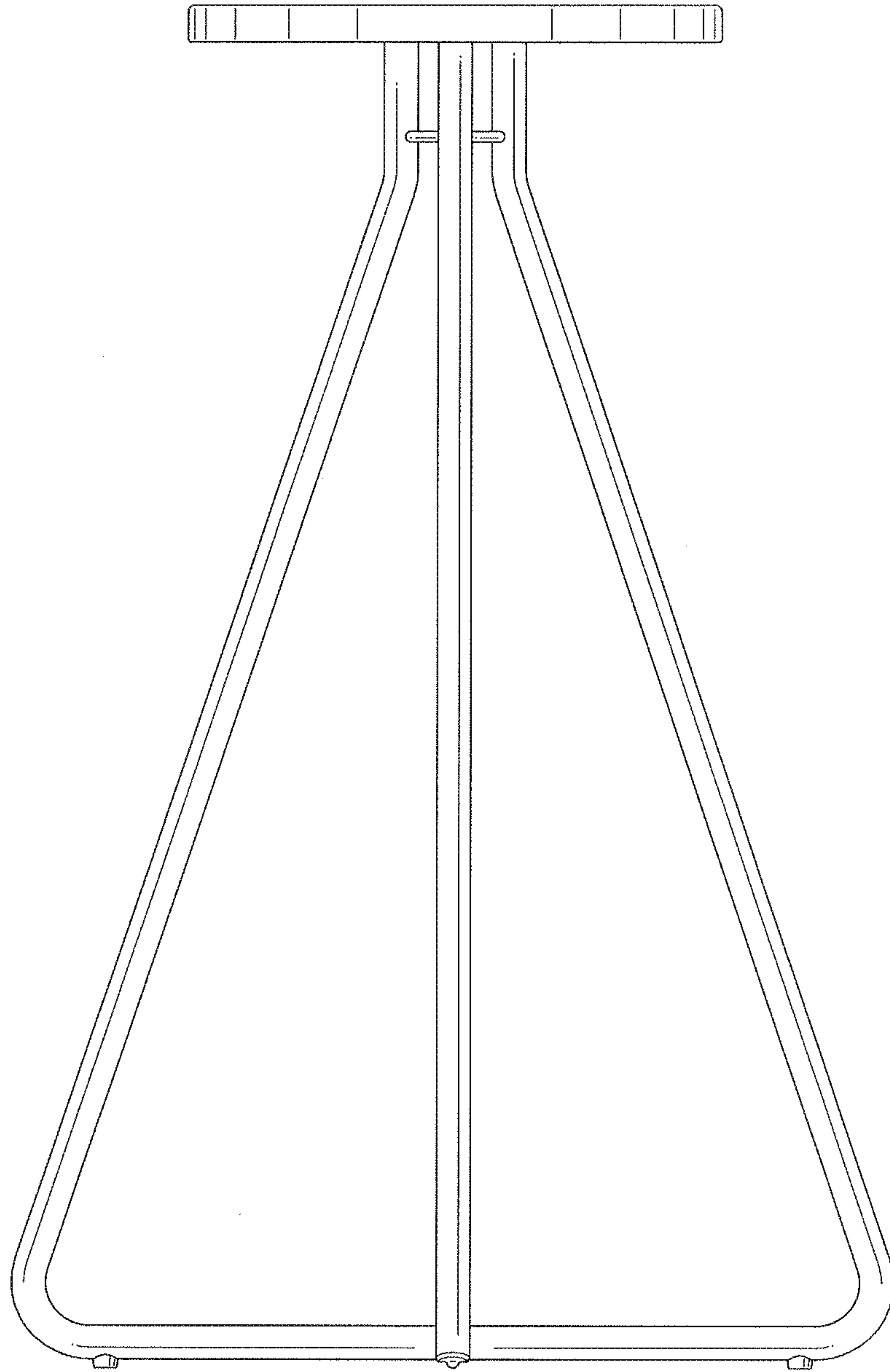

Fig. 5

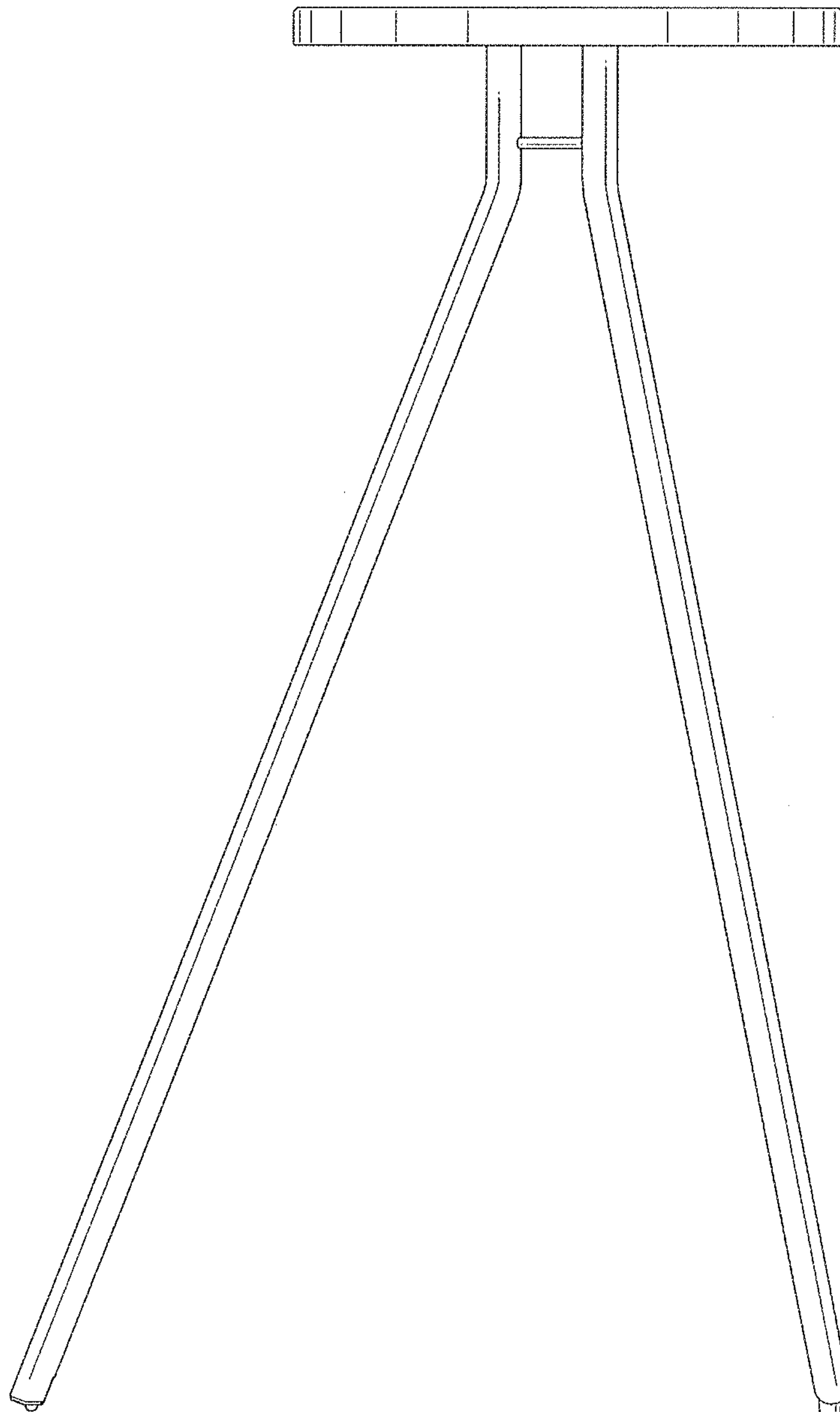

Fig. 6

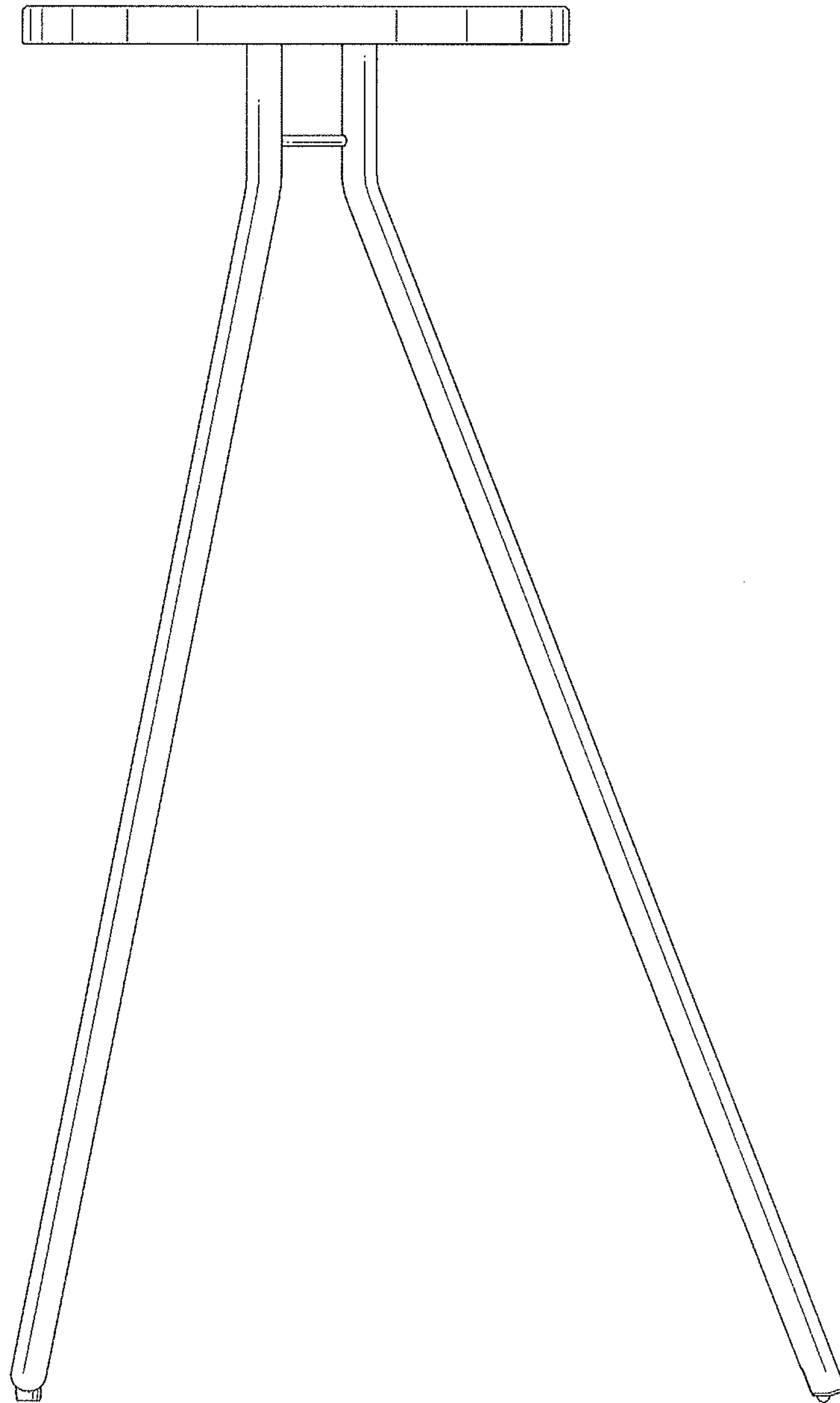

Fig. 7

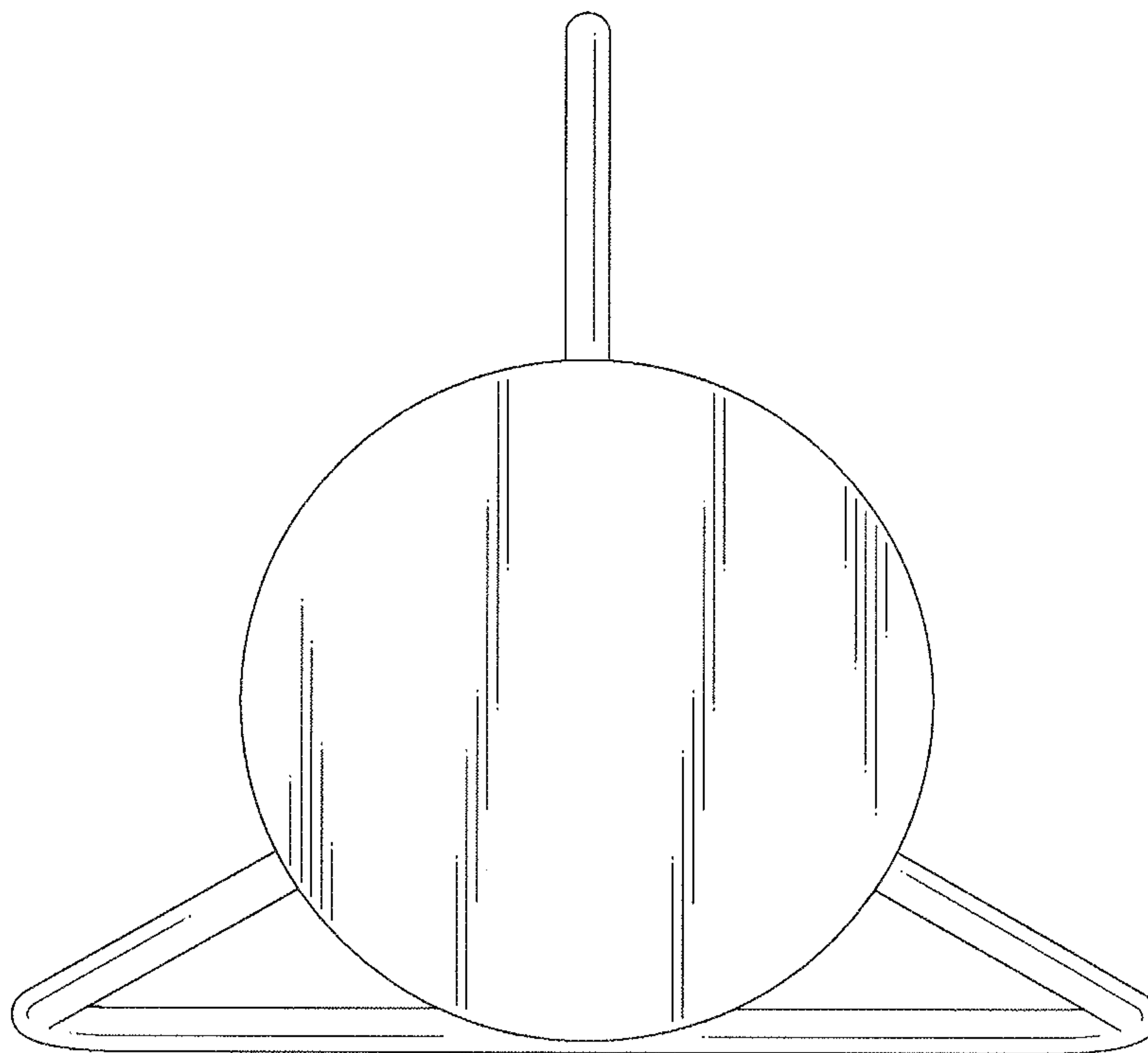

Fig. 8

