



US00D780389S

(12) **United States Design Patent**
Mitchell et al.

(10) **Patent No.:** **US D780,389 S**

(45) **Date of Patent:** **** Feb. 28, 2017**

(54) **VACUUM CLEANER**

(71) Applicant: **Dyson Technology Limited**, Wiltshire (GB)

(72) Inventors: **Joanne Katy Mitchell**, Swindon (GB); **Paul Dawson**, Scunthorpe (GB); **James Dyson**, Bristol (GB); **Peter David Gammack**, Swindon (GB)

(73) Assignee: **Dyson Technology Limited**, Malmesbury, Wiltshire (GB)

(**) Term: **14 Years**

(21) Appl. No.: **29/519,095**

(22) Filed: **Mar. 2, 2015**

(30) **Foreign Application Priority Data**

Aug. 28, 2014 (EP) 001419931-0004

(51) **LOC (10) Cl.** **15-05**

(52) **U.S. Cl.**
USPC **D32/21**

(58) **Field of Classification Search**
USPC D32/18, 21-24, 31
CPC . A47L 9/16; A47L 9/20; A47L 9/1683; A47L 9/1666; A47L 9/1608; A47L 9/2857; A47L 9/2842; A47L 9/2836; A47L 9/2847; A47L 9/2852; A47L 5/28; A47L 7/0038; G06N 3/008; E04H 4/1654
See application file for complete search history.

(56) **References Cited**

U.S. PATENT DOCUMENTS

D527,854 S 9/2006 Marzynski
D548,411 S 8/2007 Schröter
D548,902 S 8/2007 Chun et al.
D556,961 S 12/2007 Swyst et al.

7,441,298 B2 10/2008 Svendsen et al.
D586,959 S 2/2009 Geringer et al.
D593,265 S 5/2009 Carr et al.
D596,815 S 7/2009 Baek
7,832,048 B2 11/2010 Harwig et al.
D658,341 S 4/2012 Nam et al.
D659,920 S 5/2012 Lee et al.
D661,032 S 5/2012 Lee et al.
D661,439 S 6/2012 Lee et al.
D661,440 S 6/2012 Lee et al.
D665,547 S 8/2012 Nam et al.
D669,235 S 10/2012 Bassett et al.
D670,877 S 11/2012 Geringer et al.

(Continued)

OTHER PUBLICATIONS

Vanderstegen-Drake et al., U.S. Office Action mailed Apr. 22, 2015, directed to U.S. Appl. No. 29/474,610; 6 pages.

(Continued)

Primary Examiner — Ruth McInroy

(74) *Attorney, Agent, or Firm* — Morrison & Foerster LLP

(57) **CLAIM**

We claim the ornamental design for a vacuum cleaner, as shown and described.

DESCRIPTION

FIG. 1 is a perspective view of a vacuum cleaner showing our new design;
FIG. 2 is a front view thereof;
FIG. 3 is a rear view thereof;
FIG. 4 is a side view thereof;
FIG. 5 is a side view of the opposite side of FIG. 4;
FIG. 6 is a top view thereof; and,
FIG. 7 is a bottom view thereof.
The details shown in broken lines form no part of the claimed design.

1 Claim, 7 Drawing Sheets

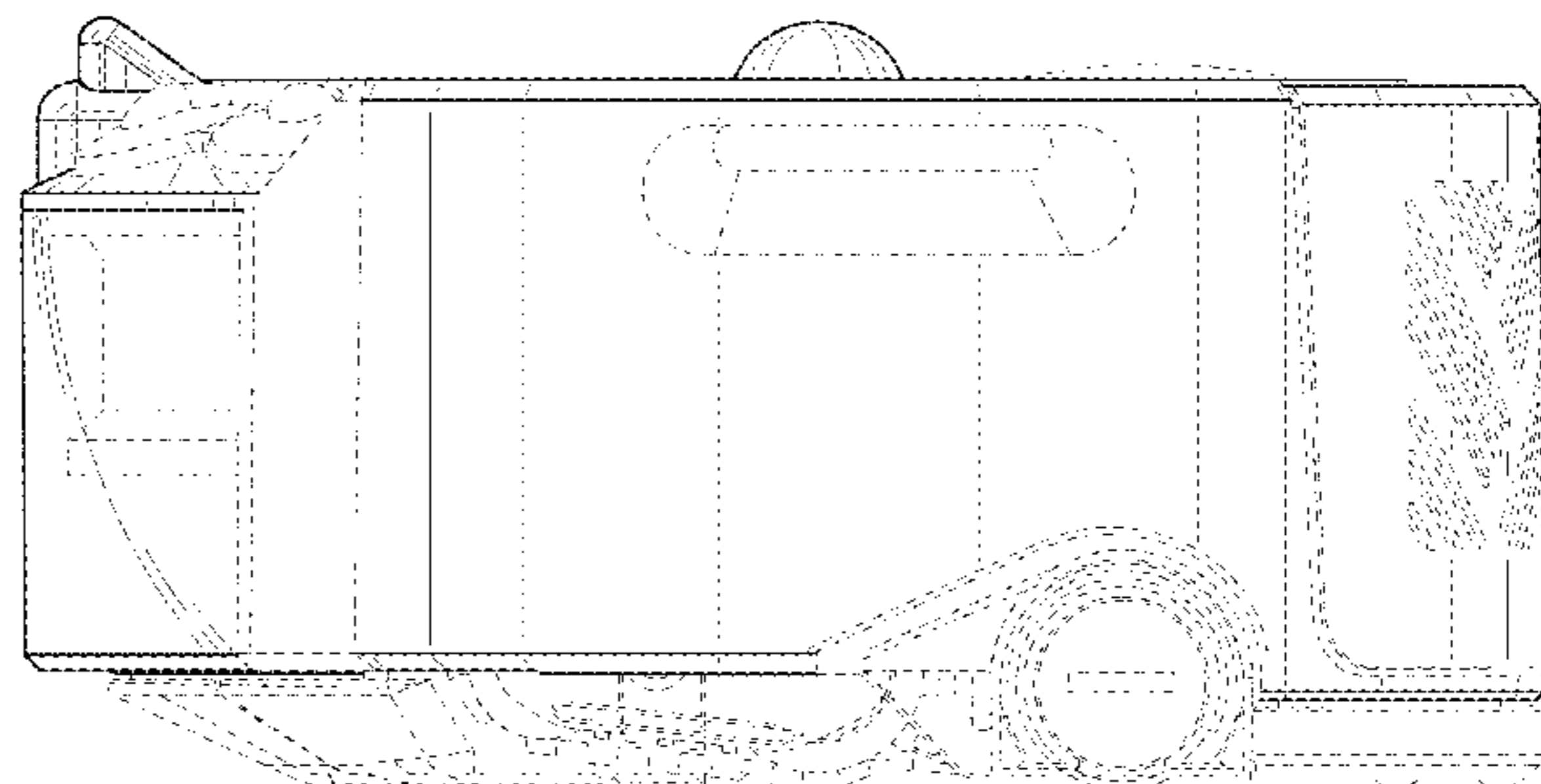
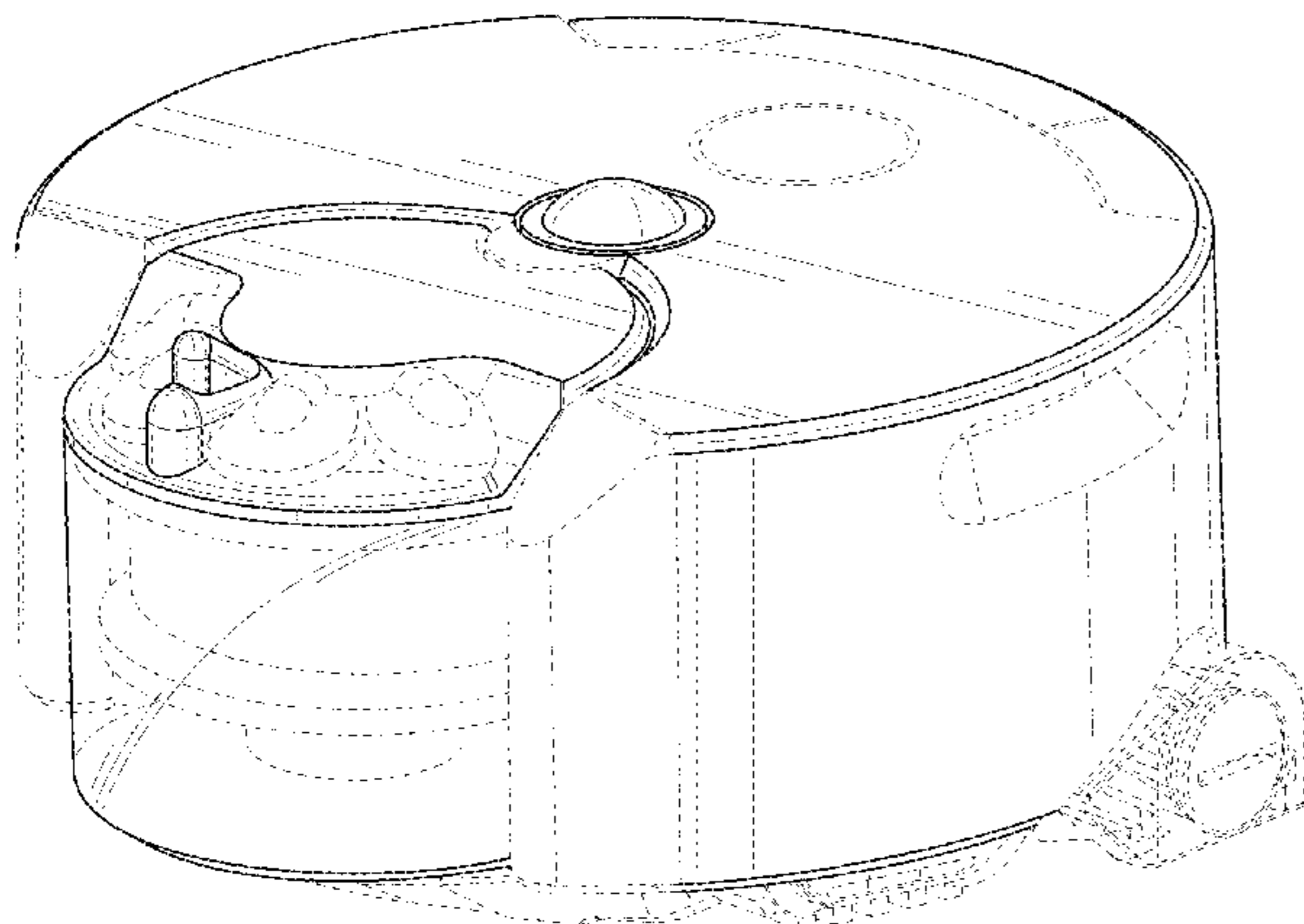

(56)

References Cited

OTHER PUBLICATIONS

U.S. PATENT DOCUMENTS

8,370,985	B2	2/2013	Schnittman et al.	
8,438,695	B2	5/2013	Gilbert, Jr. et al.	
D690,478	S	9/2013	Li et al.	
D691,337	S	10/2013	Kim et al.	
8,584,307	B2	11/2013	Won et al.	
8,627,542	B2	1/2014	Kim et al.	
D710,558	S *	8/2014	Mitchell	D32/21
D710,559	S *	8/2014	Mitchell	D32/21
D718,911	S *	12/2014	Vanderstegen-Drake	D32/21
D753,356	S *	4/2016	Vanderstegen-Drake	D32/21
2006/0288519	A1	12/2006	Jaworski et al.	
2007/0266508	A1	11/2007	Jones et al.	
2011/0191976	A1	8/2011	Yan	
2012/0023699	A1	2/2012	Shim et al.	
2012/0047676	A1	3/2012	Jung et al.	
2012/0084934	A1	4/2012	Li	
2012/0317744	A1	12/2012	Gilbert, Jr. et al.	
2012/0317745	A1	12/2012	Jung et al.	
2013/0025085	A1	1/2013	Kim et al.	
2013/0061417	A1	3/2013	Vanderstegen-Drake et al.	
2013/0086760	A1	4/2013	Han et al.	
2013/0152332	A1	6/2013	Jang	
2013/0305484	A1 *	11/2013	Dyson	A47L 9/009 15/353
2013/0340201	A1	12/2013	Jang et al.	
2014/0312813	A1	10/2014	Murchie et al.	
2016/0058259	A1 *	3/2016	Mitchell	A47L 9/1633 15/353

Vanderstegen-Drake et al., U.S. Office Action mailed Aug. 12, 2015, directed to U.S. Appl. No. 29/474,610; 10 pages.

Vanderstegen-Drake et al., U.S. Office Action mailed Jan. 27, 2014, directed to U.S. Appl. No. 29/450,789; 8 pages.

Vanderstegen-Drake et al., U.S. Office Action mailed Jun. 27, 2014, directed to U.S. Appl. No. 29/450,789; 7 pages.

Mitchell et al, U.S. Office Action mailed Jan. 27, 2014, directed to U.S. Appl. No. 29/450,791; 8 pages.

Mitchell et al, U.S. Office Action mailed Jan. 24, 2014, directed to U.S. Appl. No. 29/450,792; 9 pages.

Gammack et al., U.S. Office Action mailed May 3, 2016, directed to U.S. Appl. No. 29/519,102; 7 pages.

Vanderstegen-Drake et al., U.S. Office Action mailed May 4, 2016, directed to U.S. Appl. No. 29/519,093; 7 pages.

Mitchell et al., U.S. Office Action mailed May 20, 2016, directed to U.S. Appl. No. 29/519,094; 10 pages.

Vanderstegen-Drake et al., U.S. Office Action mailed May 3, 2016, directed to U.S. Appl. No. 29/519,097; 6 pages.

Vanderstegen-Drake et al., U.S. Office Action mailed May 20, 2016, directed to U.S. Appl. No. 29/519,116; 6 pages.

Vanderstegen-Drake et al., U.S. Office Action mailed May 3, 2016, directed to U.S. Appl. No. 29/519,118; 5 pages.

Vanderstegen-Drake et al., U.S. Office Action mailed May 31, 2016, directed to U.S. Appl. No. 29/555,300; 9 pages.

* cited by examiner

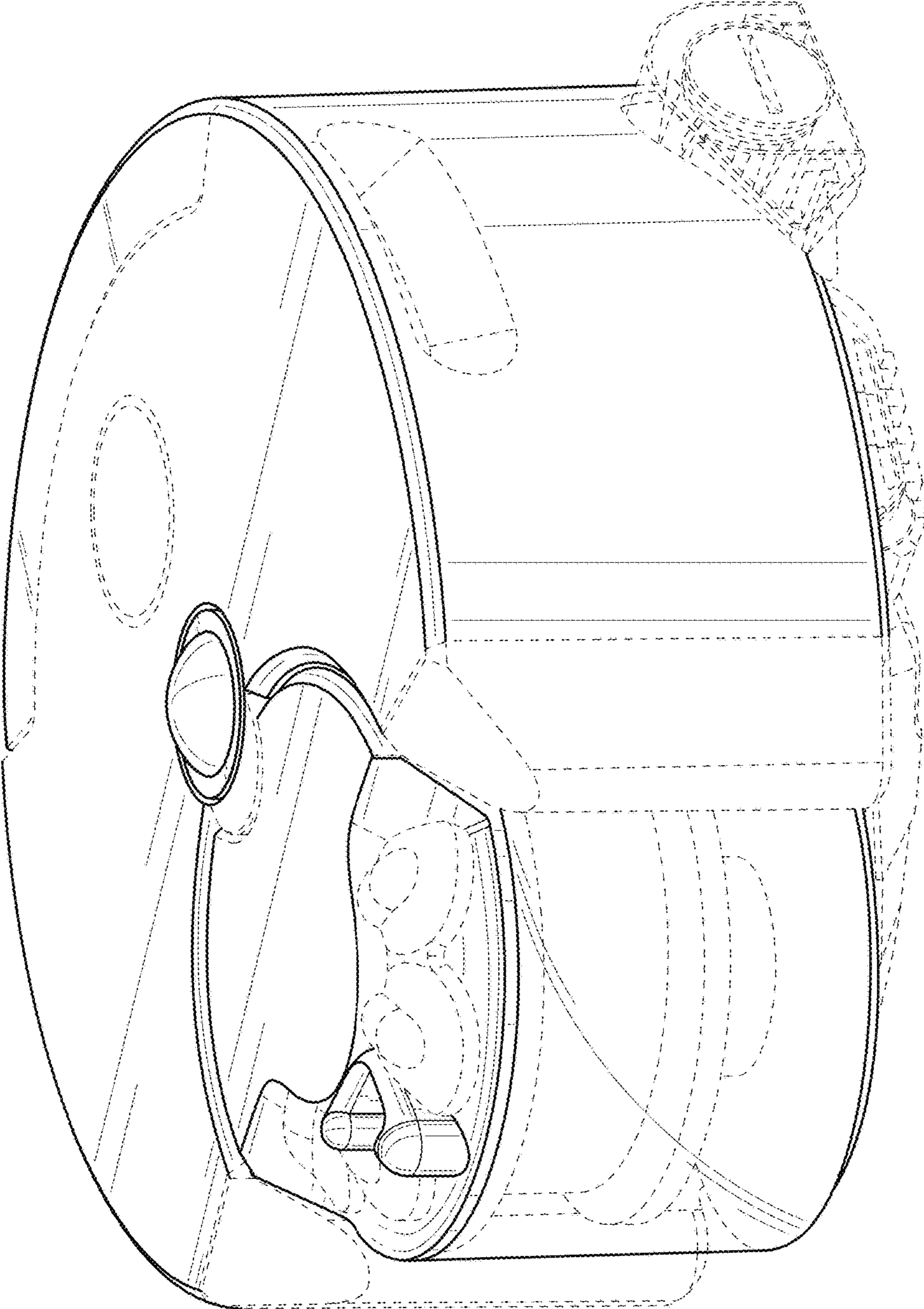

FIG. 1

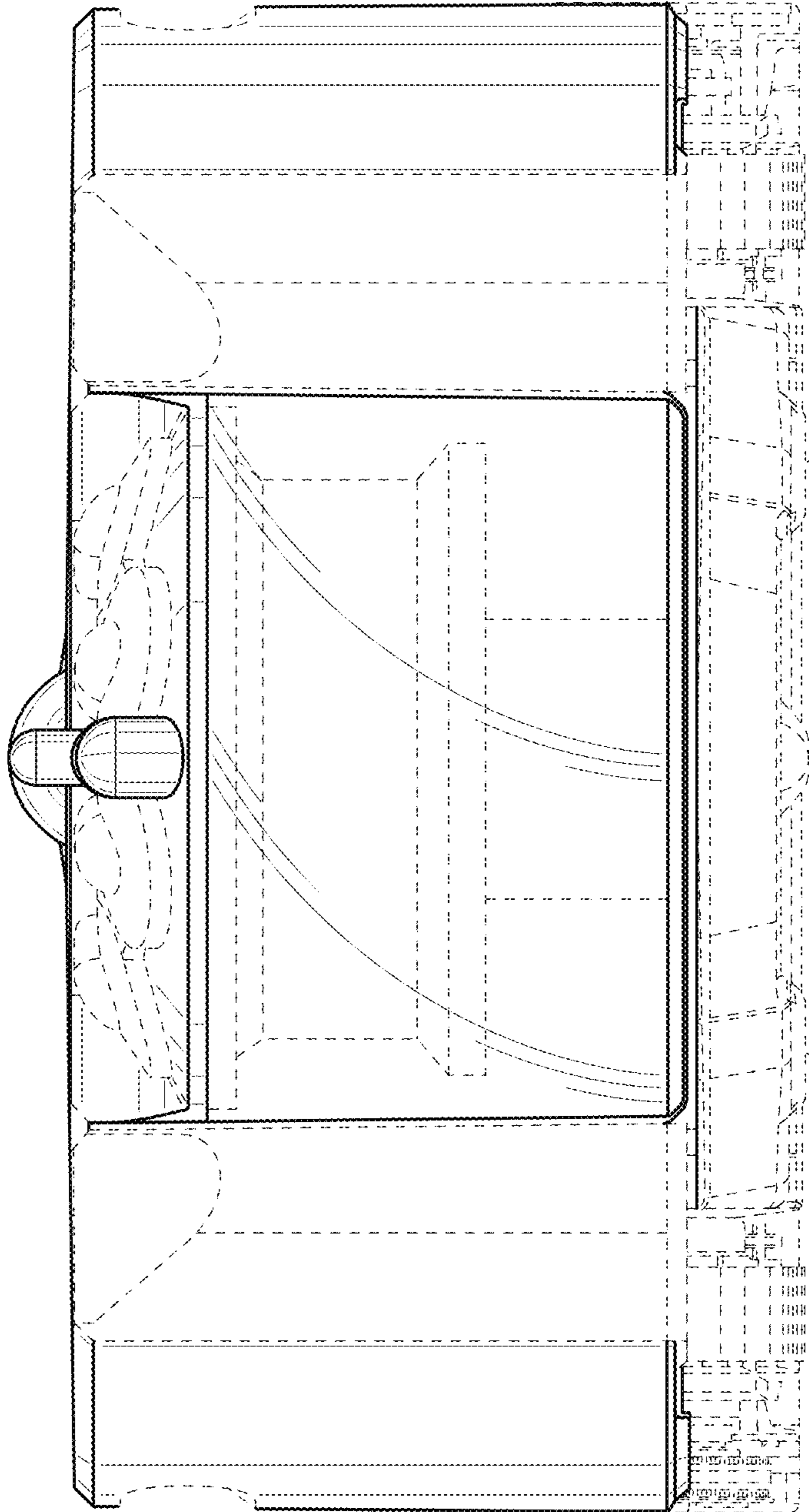

FIG. 2

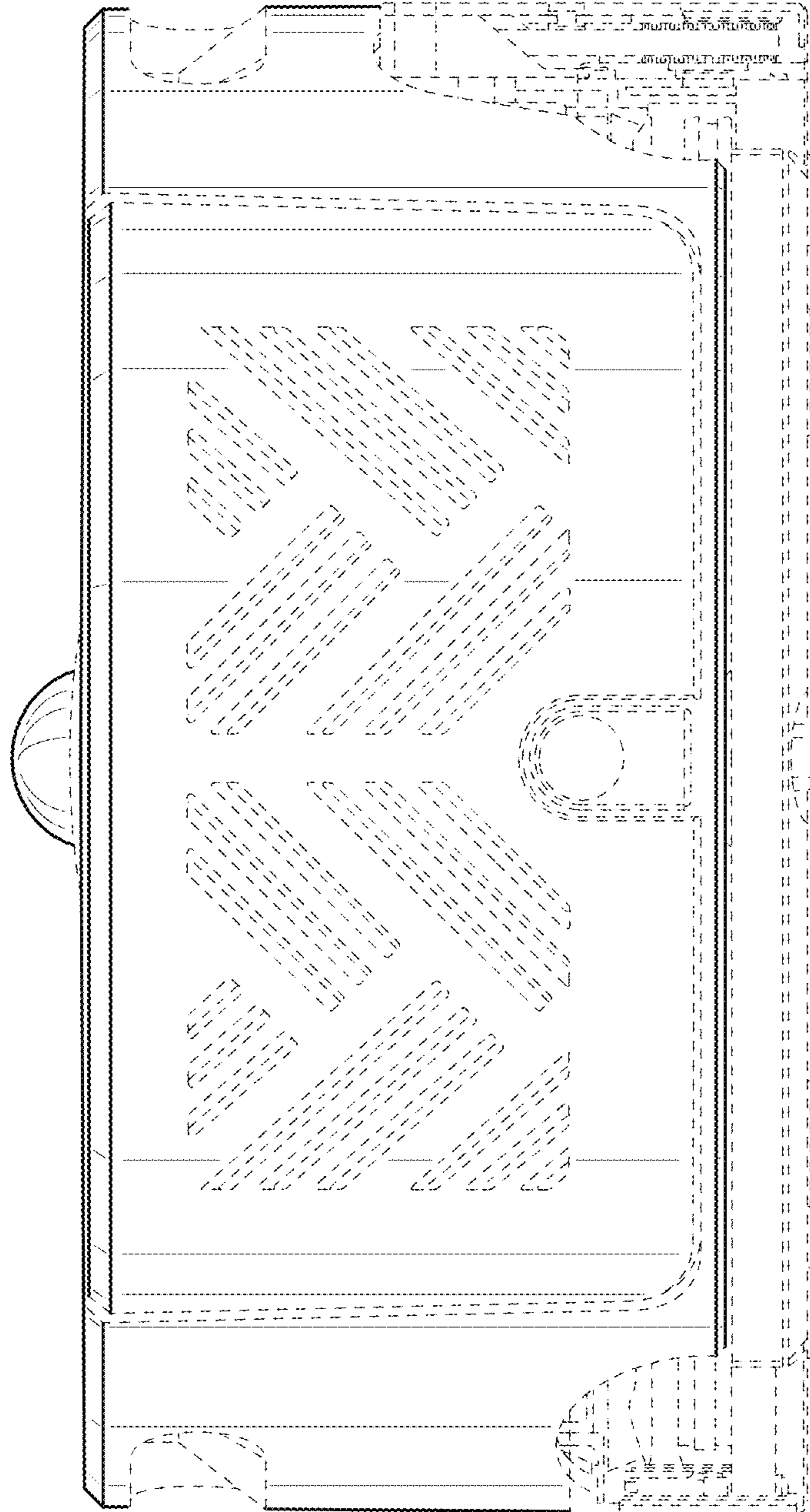

FIG. 3

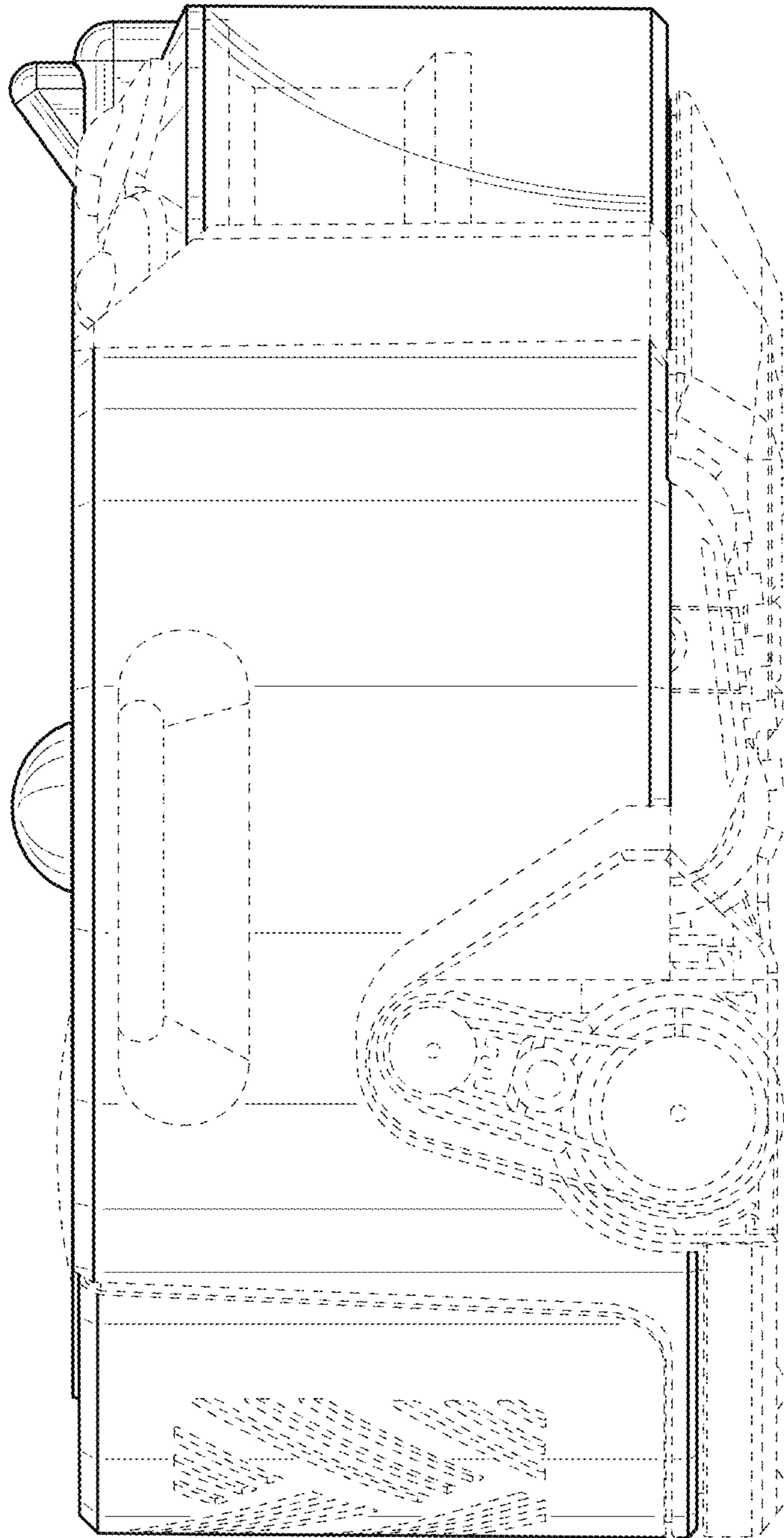

FIG. 4

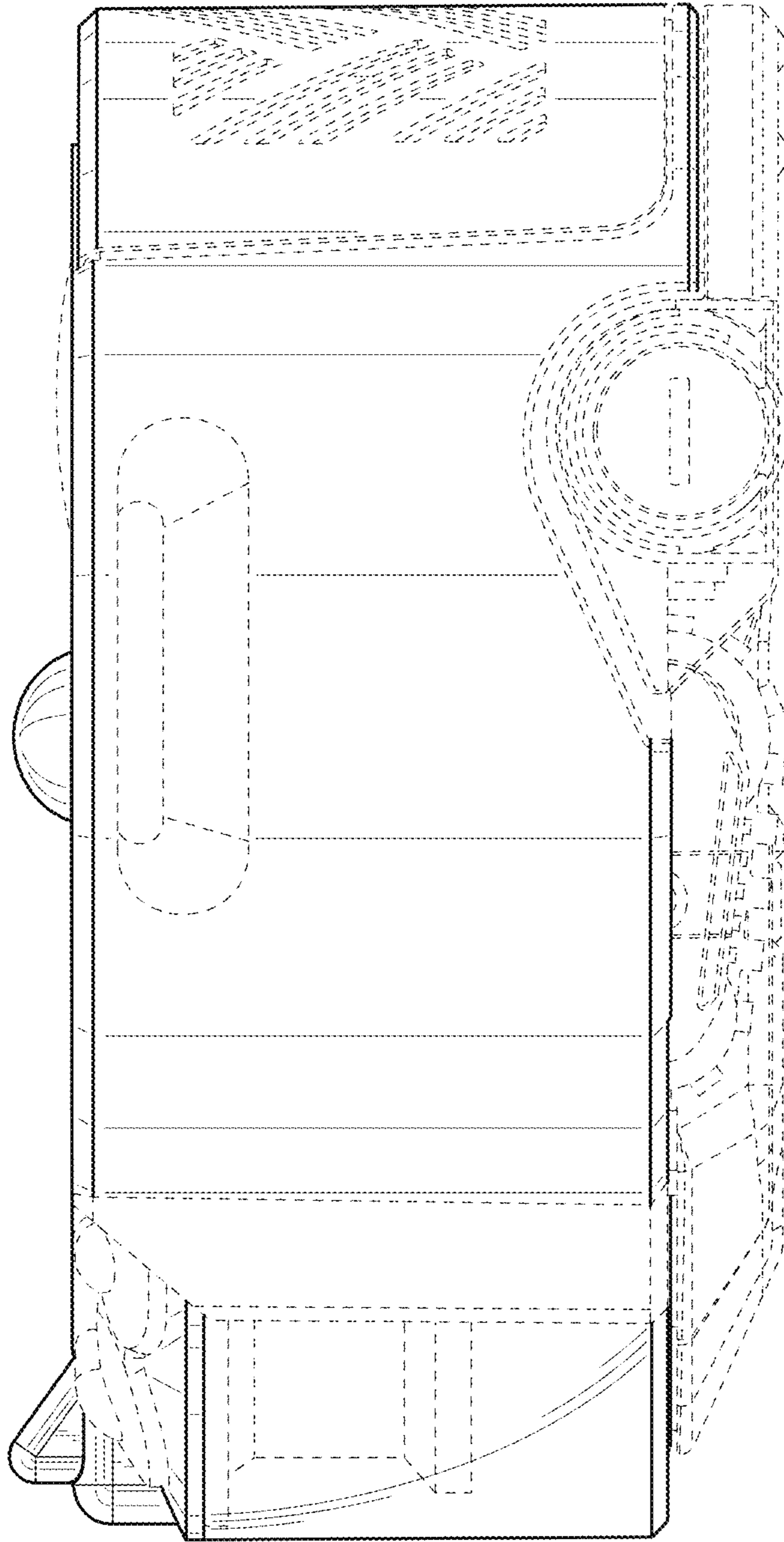

FIG. 5

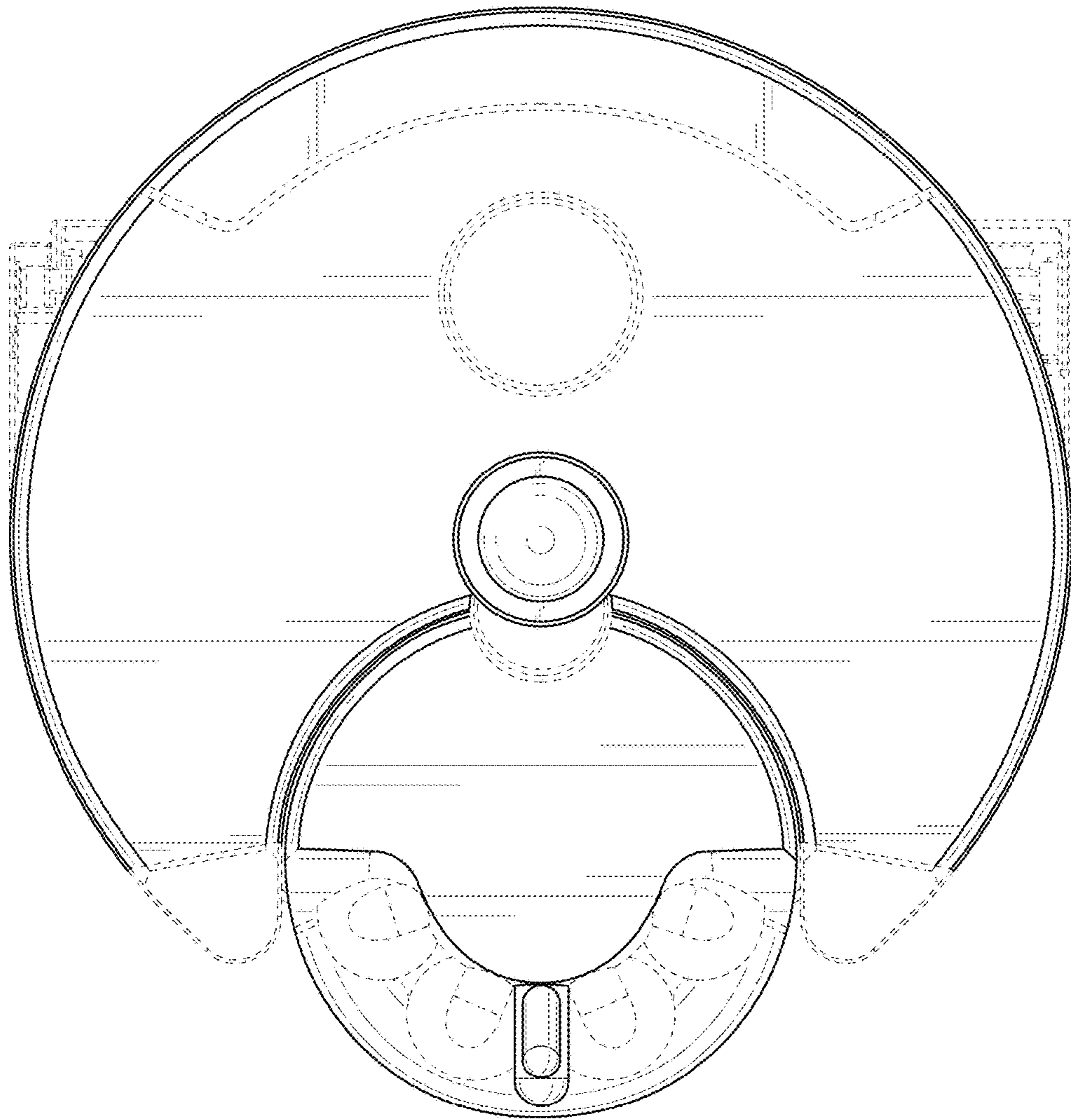

FIG. 6

