



US00D780374S

(12) **United States Design Patent** (10) **Patent No.:** **US D780,374 S**
Yu et al. (45) **Date of Patent:** **** Feb. 28, 2017**

(54) **HAIR STRAIGHTENING AND STYLING IRON**

D627,513 S * 11/2010 Kim D28/35
D651,742 S * 1/2012 Kim D28/35
D672,088 S * 12/2012 Julemont D28/35
D682,467 S * 5/2013 Kim D28/35

(71) Applicant: **T3 Micro, Inc.**, Venice, CA (US)

* cited by examiner

(72) Inventors: **Kent Yu**, Venice, CA (US); **Paul Pofcher**, Venice, CA (US); **Michael Rocha**, Venice, CA (US); **George Watson**, Venice, CA (US); **Matt Longbottom**, Venice, CA (US); **Mark Jones**, Venice, CA (US)

Primary Examiner — Jennifer Rivard
(74) *Attorney, Agent, or Firm* — Troutman Sanders LLP

(73) Assignee: **T3 MICRO, INC.**, Venice, CA (US)

(57) **CLAIM**

The ornamental design for a hair straightening and styling iron, substantially as shown and described.

(**) Term: **15 Years**

DESCRIPTION

(21) Appl. No.: **29/542,754**

(22) Filed: **Oct. 16, 2015**

(51) **LOC (10) Cl.** **28-03**

(52) **U.S. Cl.**
USPC **D28/35**

(58) **Field of Classification Search**
USPC D28/35, 10
CPC ... A45D 1/00–1/28; A45D 2/00; A45D 2/001;
A45D 2/002; A45D 2/02; A45D 2/04;
A45D 2/06; A45D 2/08; A45D
2/10; A45D 2/12–2/22; A45D 2/24–2/34;
A45D 2/36–2/367; A45D 2/38–2/44
See application file for complete search history.

FIG. 1 is a top plan view of the a hair straightening and styling iron in the open position;
FIG. 2 is a left side view thereof, the right side being a mirror image;
FIG. 3 is a bottom side view thereof;
FIG. 4 is a front side view thereof;
FIG. 5 is a rear side view thereof;
FIG. 6 is a front, top, left perspective view thereof;
FIG. 7 is a rear, top, left perspective view thereof;
FIG. 8 is a top plan view of the a hair straightening and styling iron in the closed position;
FIG. 9 is a left side view of FIG. 8, the right side being a mirror image thereof;
FIG. 10 is a bottom side view of FIG. 8;
FIG. 11 is a front side view of FIG. 8;
FIG. 12 is a rear side view of FIG. 8;
FIG. 13 is a front, top, left perspective view of FIG. 8; and,
FIG. 14 is a rear, top, left perspective view of FIG. 8.

(56) **References Cited**

U.S. PATENT DOCUMENTS

D599,058 S * 8/2009 Kim D28/35
D609,401 S * 2/2010 Yang D28/35

1 Claim, 4 Drawing Sheets

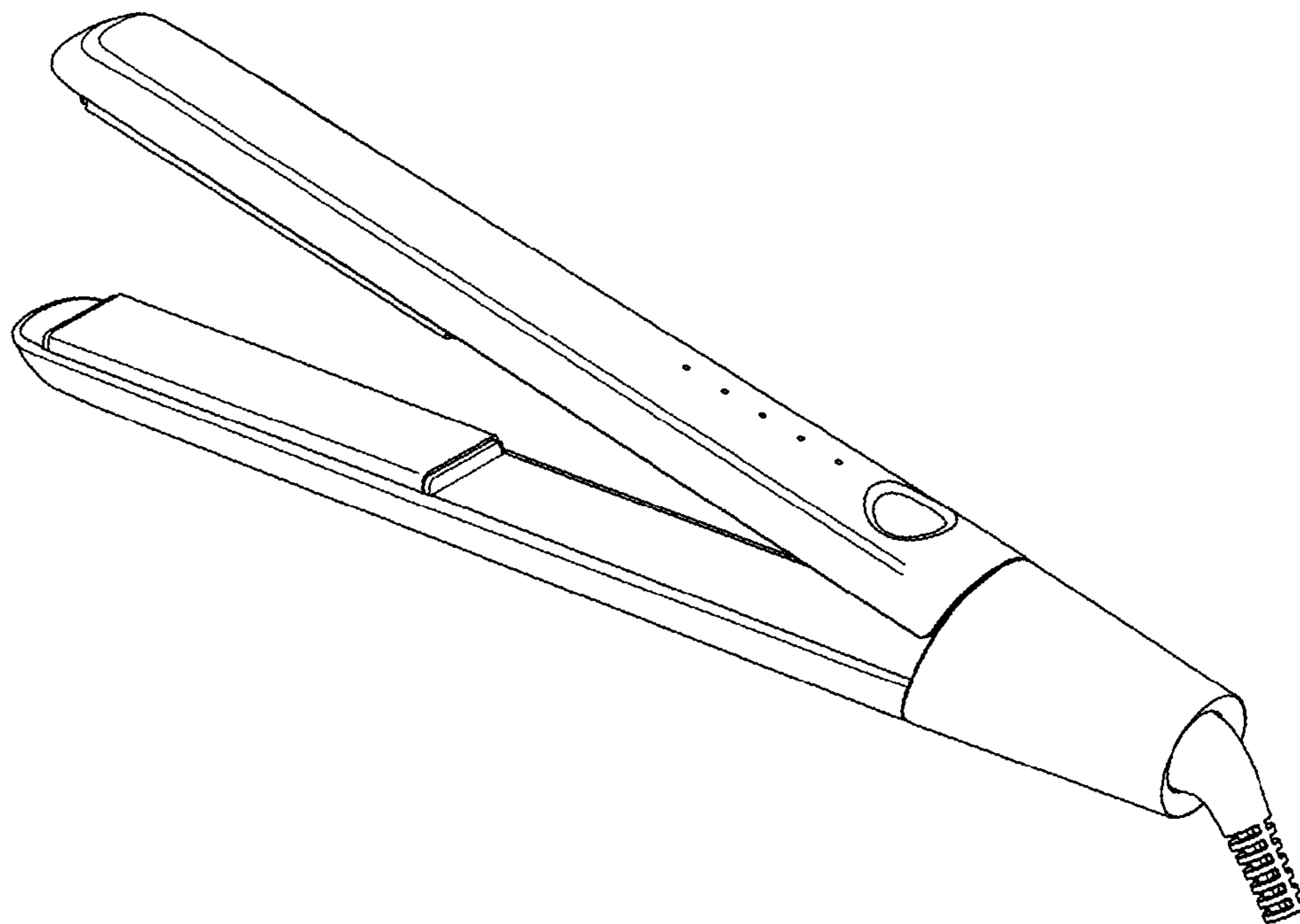

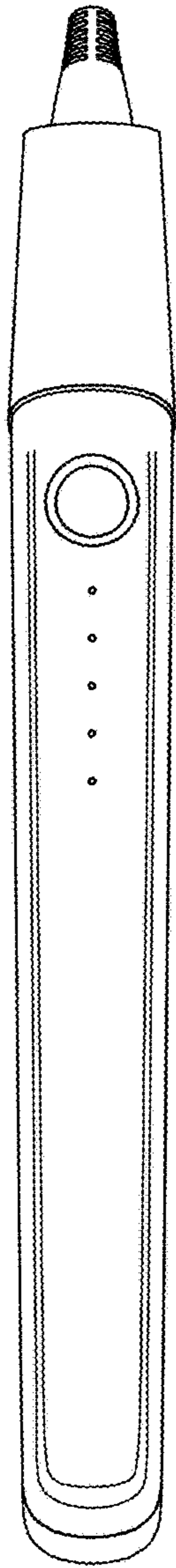

FIG. 1

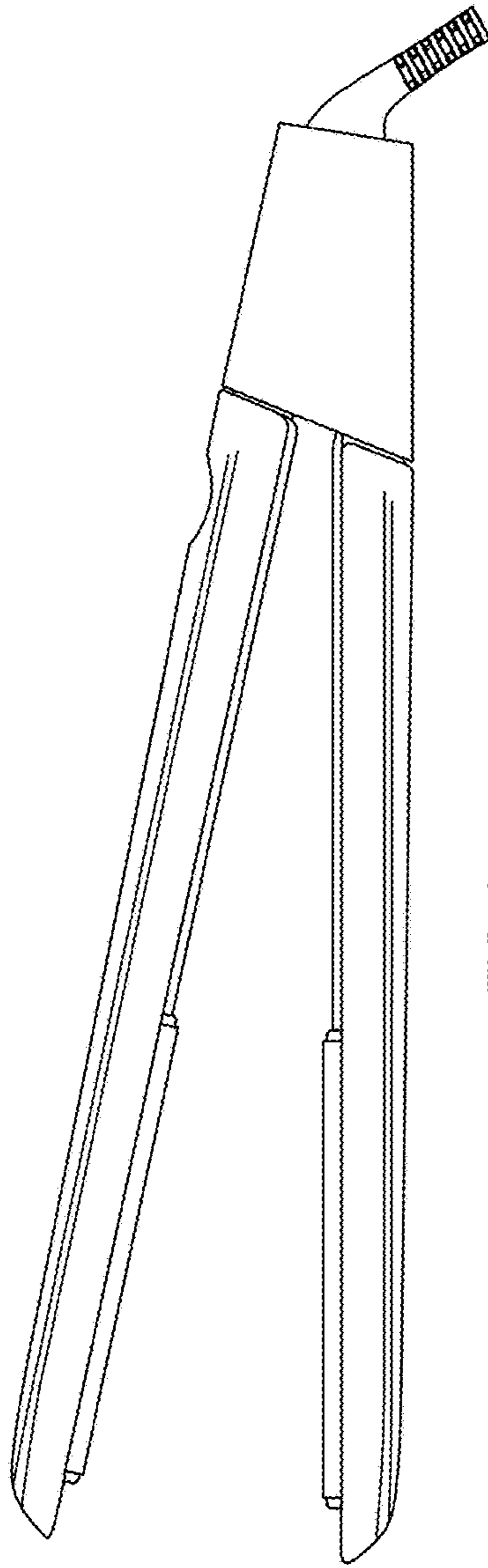

FIG. 2

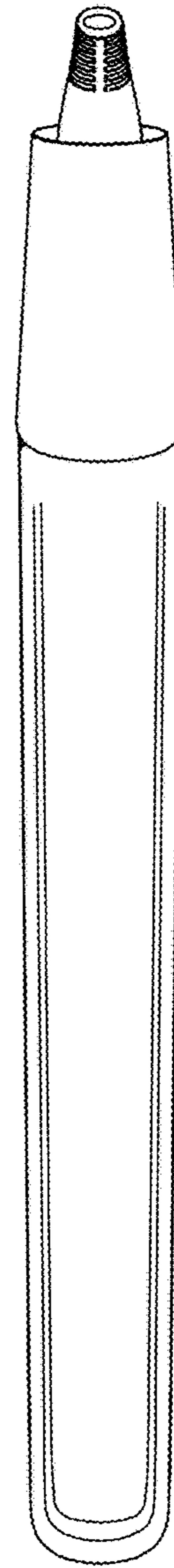

FIG. 3

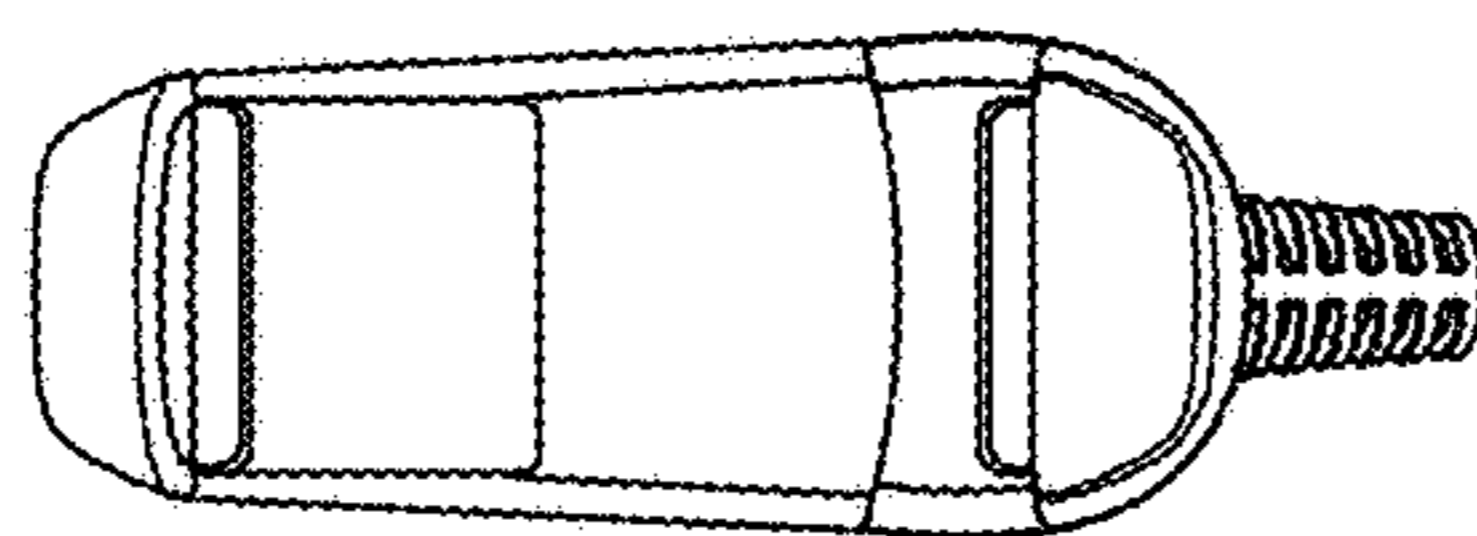

FIG. 4

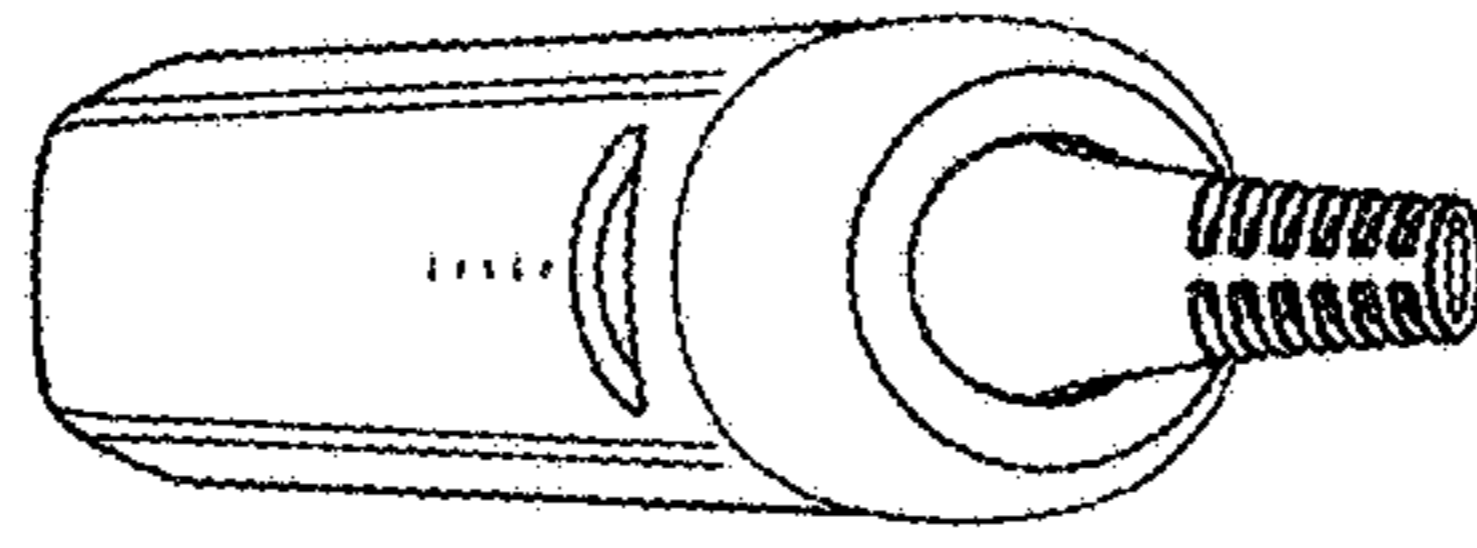
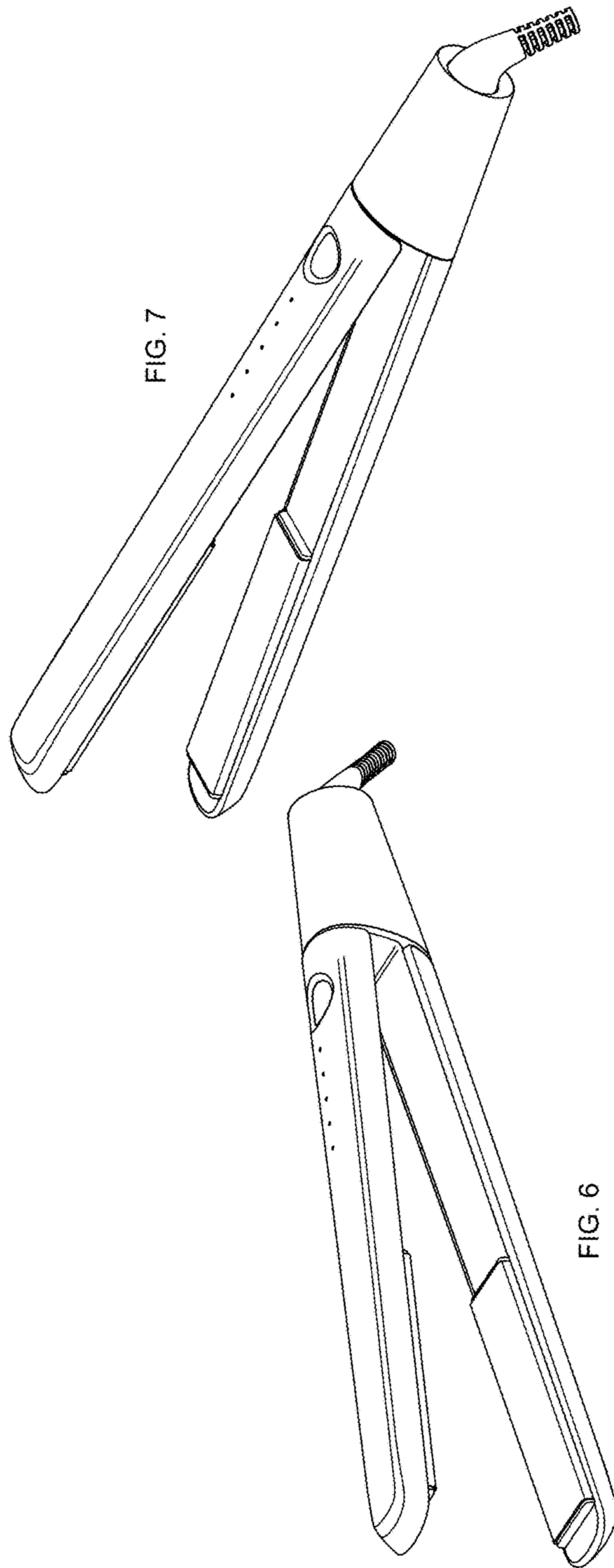

FIG. 5



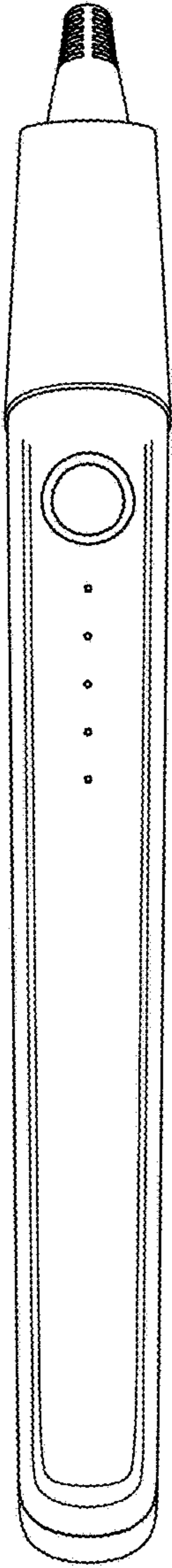

FIG. 8

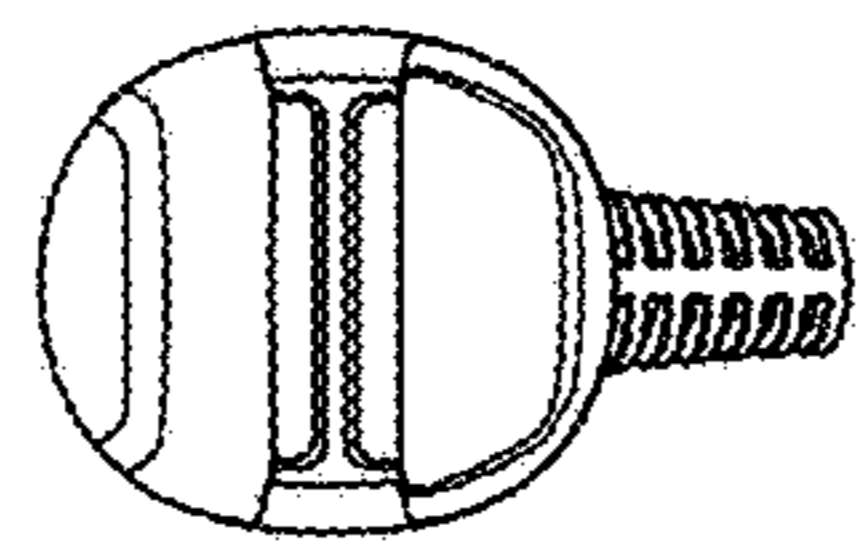

FIG. 11

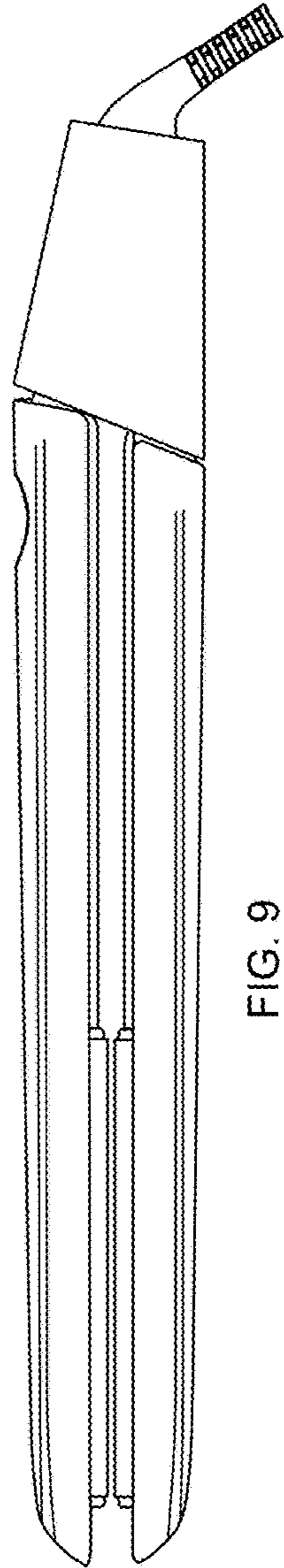

FIG. 9

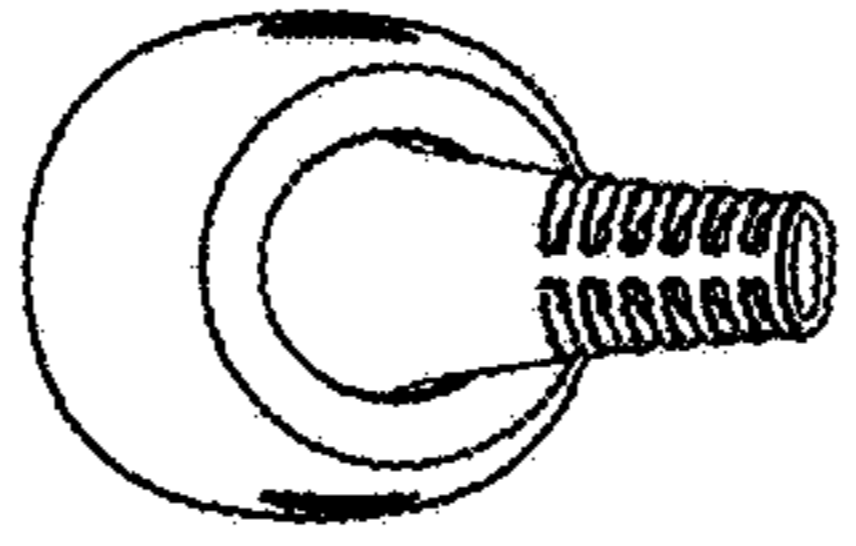

FIG. 12

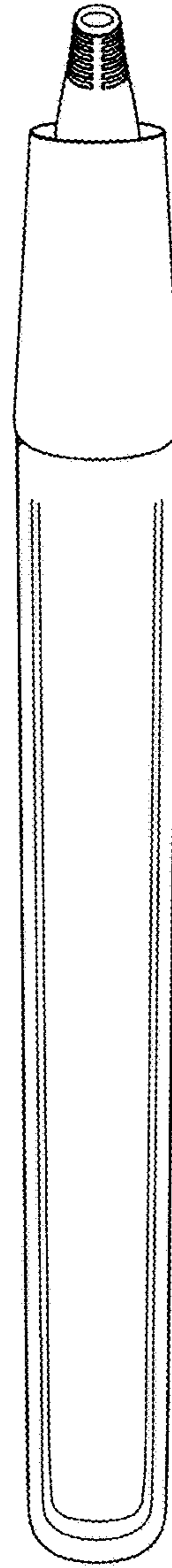

FIG. 10

