



US00D780274S

(12) **United States Design Patent** (10) **Patent No.:** **US D780,274 S**
Bacon et al. (45) **Date of Patent:** **** Feb. 28, 2017**

(54) **BADGE FOR A GOLF CLUB HEAD**
(71) Applicant: **Karsten Manufacturing Corporation**,
Phoenix, AZ (US)
(72) Inventors: **Cory Bacon**, Phoenix, AZ (US);
Xiaojian Chen, Phoenix, AZ (US)
(73) Assignee: **Karsten Manufacturing Corporation**,
Phoenix, AZ (US)

(**) Term: **15 Years**

(21) Appl. No.: **29/540,656**

(22) Filed: **Sep. 25, 2015**

(51) **LOC (10) Cl.** **21-02**

(52) **U.S. Cl.**
USPC **D21/759**

(58) **Field of Classification Search**
USPC D21/747-751, 759
CPC A63B 53/00; A63B 53/04; A63B 53/047;
A63B 53/0475

See application file for complete search history.

(56) **References Cited**

U.S. PATENT DOCUMENTS

D179,816 S	3/1957	Penna
D179,817 S	3/1957	Penna
D244,558 S	5/1977	Elkins, Jr.
D244,792 S	6/1977	Gelinas
D250,136 S	10/1978	Gelinas
D361,813 S	8/1995	Guibaud
5,492,327 A	2/1996	Biafore, Jr.
5,564,705 A	10/1996	Kobayashi
5,593,356 A	1/1997	Takeda
D381,385 S	7/1997	Shinohara et al.
5,658,206 A	8/1997	Antonious
D398,355 S	9/1998	Chou

D409,702 S	5/1999	Gallagher
D420,080 S	2/2000	Gates
D424,146 S	5/2000	Maltby
D428,632 S	7/2000	Besnard
D435,073 S	12/2000	Stone
D435,277 S	12/2000	Erikson
6,210,290 B1	4/2001	Erikson
D442,245 S	5/2001	Roach
6,251,029 B1	6/2001	Roberts
D445,862 S	7/2001	Ford
D453,949 S	2/2002	Helmstetter
D480,440 S	10/2003	Rollinson
D481,775 S	11/2003	Best
D494,240 S	8/2004	Schweigert
D494,648 S	8/2004	Schweigert
D494,649 S	8/2004	Imamoto
D495,390 S	8/2004	Pinder

(Continued)

Primary Examiner — Mitchell Siegel

(57) **CLAIM**

The ornamental design for a badge for a golf club head, as shown and described.

DESCRIPTION

FIG. 1 is a top perspective view of a badge for a golf club head;

FIG. 2 is a bottom perspective view of the badge of FIG. 1;

FIG. 3 is a front view of the badge of FIG. 1;

FIG. 4 is a rear view of the badge of FIG. 1;

FIG. 5 is a top view of the badge of FIG. 1;

FIG. 6 is a bottom view of the badge of FIG. 1;

FIG. 7 is a left view of the badge of FIG. 1; and,

FIG. 8 is a right view of the badge of FIG. 1.

The broken lines shown in one or more of the figures are for illustrative purposes only and form no part of the claimed design.

1 Claim, 3 Drawing Sheets

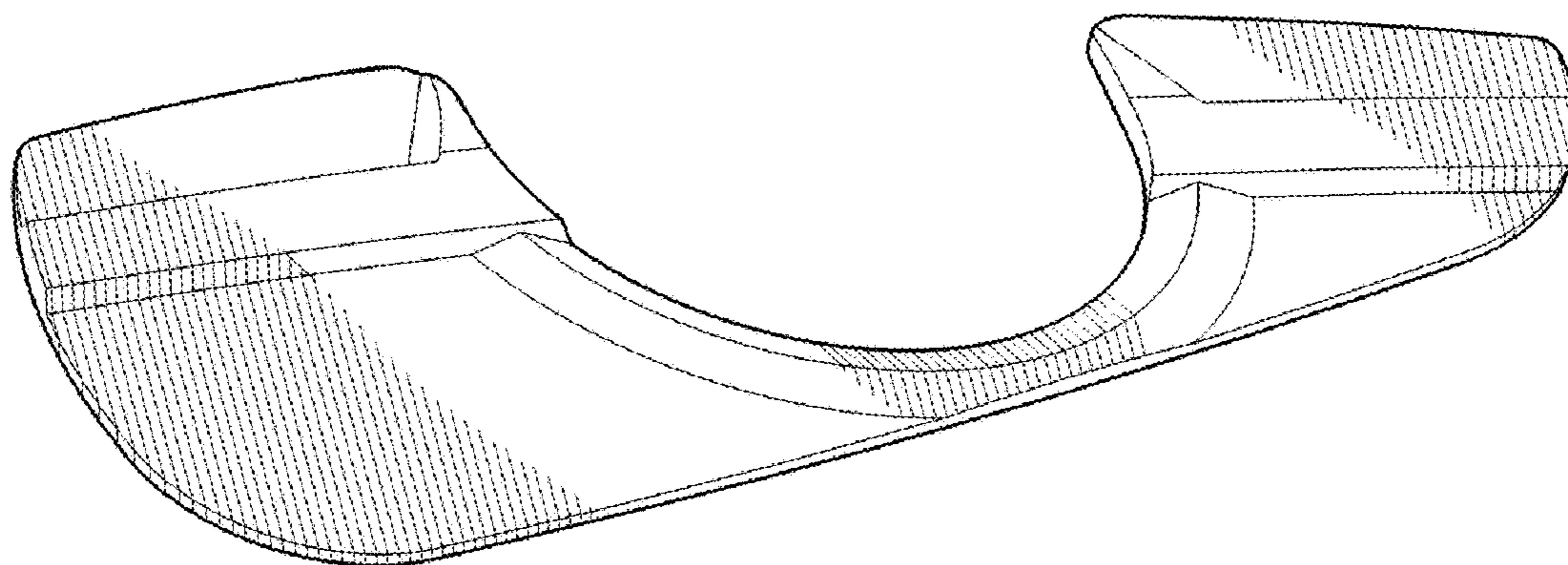

(56)

References Cited

U.S. PATENT DOCUMENTS

D500,350 S	12/2004	Schweigert	D561,855 S	2/2008	Schweigert	
D500,351 S	12/2004	Schweigert	D562,925 S	2/2008	Schweigert	
D502,237 S	2/2005	Schweigert	D570,942 S	6/2008	Chen	
D502,975 S	3/2005	Schweigert	D570,943 S	6/2008	Chen	
D504,925 S	5/2005	Schweigert	D571,425 S	6/2008	Chen	
D505,171 S	5/2005	Schweigert	D571,426 S	6/2008	Chen	
D507,321 S	7/2005	Dogan	D571,427 S	6/2008	Schweigert	
D507,614 S	7/2005	Schweigert	D572,329 S *	7/2008	Nicolette	D21/759
D508,099 S	8/2005	Schweigert	D573,219 S	7/2008	Schweigert	
D509,868 S	9/2005	Imamoto	D574,915 S	8/2008	Jones	
D514,183 S	1/2006	Schweigert	D577,783 S	9/2008	Schweigert	
D516,649 S	3/2006	Imamoto	D578,590 S	10/2008	Schweigert	
7,066,834 B2	6/2006	Yamamoto	D581,004 S *	11/2008	Schweigert	D21/759
D525,330 S	7/2006	Imamoto	D596,258 S *	7/2009	Jertson	D21/759
D526,375 S	8/2006	Kawami	D596,688 S *	7/2009	Schweigert	D21/759
D528,617 S	9/2006	Imamoto	D600,298 S	9/2009	Serrano	
D530,759 S	10/2006	Nicolette	D621,893 S	8/2010	Nicolette	
D530,760 S	10/2006	Schweigert	D621,895 S *	8/2010	Schweigert	D21/759
D532,849 S	11/2006	Nicolette	D627,409 S *	11/2010	Schweigert	D21/759
D534,228 S	12/2006	Nicolette	D649,211 S *	11/2011	Jertson	D21/759
D534,597 S	1/2007	Nicolette	D651,268 S *	12/2011	Nicolette	D21/759
D536,759 S	2/2007	Schweigert	D673,633 S	1/2013	Jertson et al.	
D538,366 S	3/2007	Nicolette	D685,041 S *	6/2013	Stokke	D21/759
D539,863 S	4/2007	Nunez	D685,042 S *	6/2013	Jertson	D21/759
D541,360 S	4/2007	Schweigert	D685,043 S *	6/2013	Stokke	D21/759
D549,795 S	8/2007	Rollinson	D709,573 S *	7/2014	Stokke	D21/759
D550,316 S	9/2007	Nagai	D710,468 S *	8/2014	Nicolette	D21/759
D554,215 S	10/2007	Ruggiero	D719,230 S *	12/2014	Chen	D21/759
			D755,316 S *	5/2016	Stokke	D21/759
			2007/0281796 A1	12/2007	Gilbert	

* cited by examiner

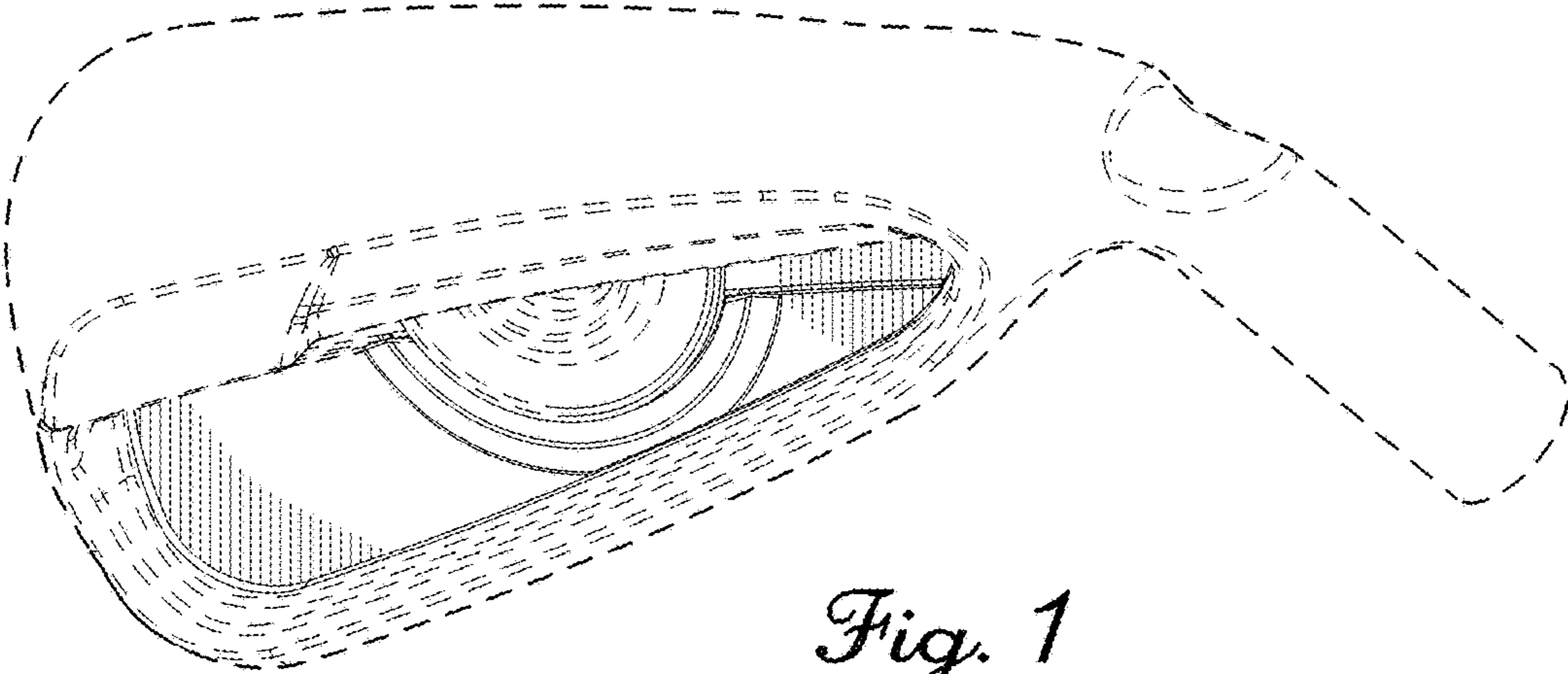

Fig. 1

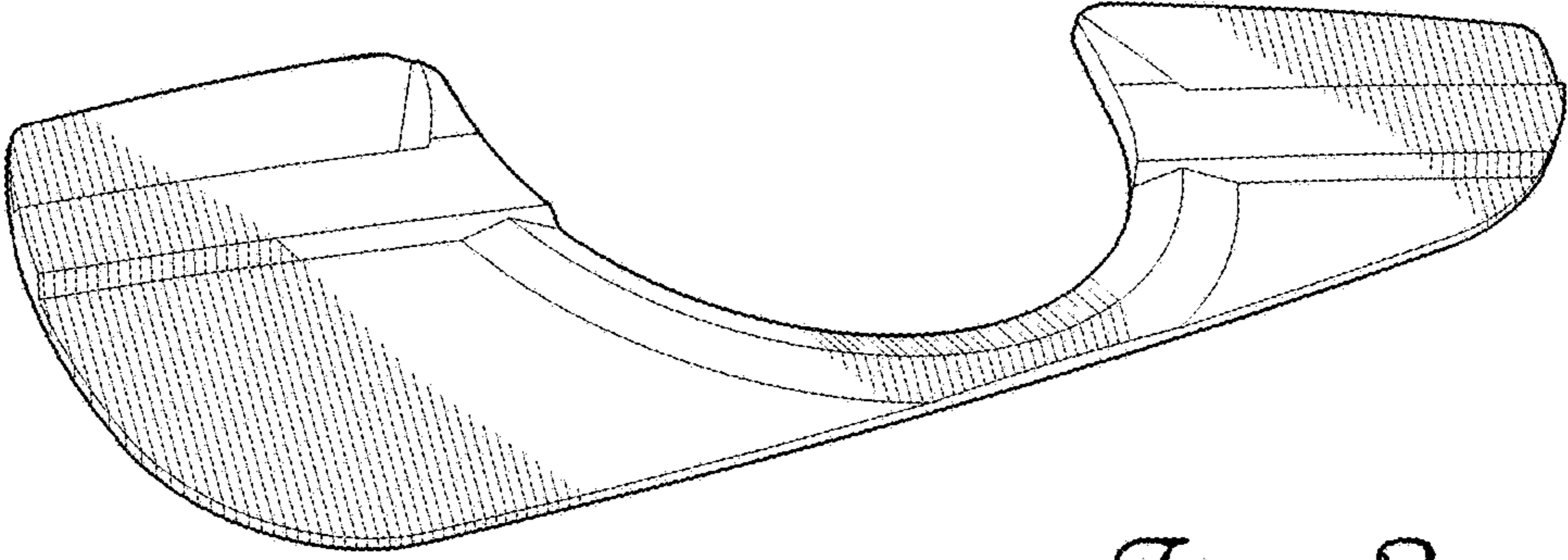

Fig. 2

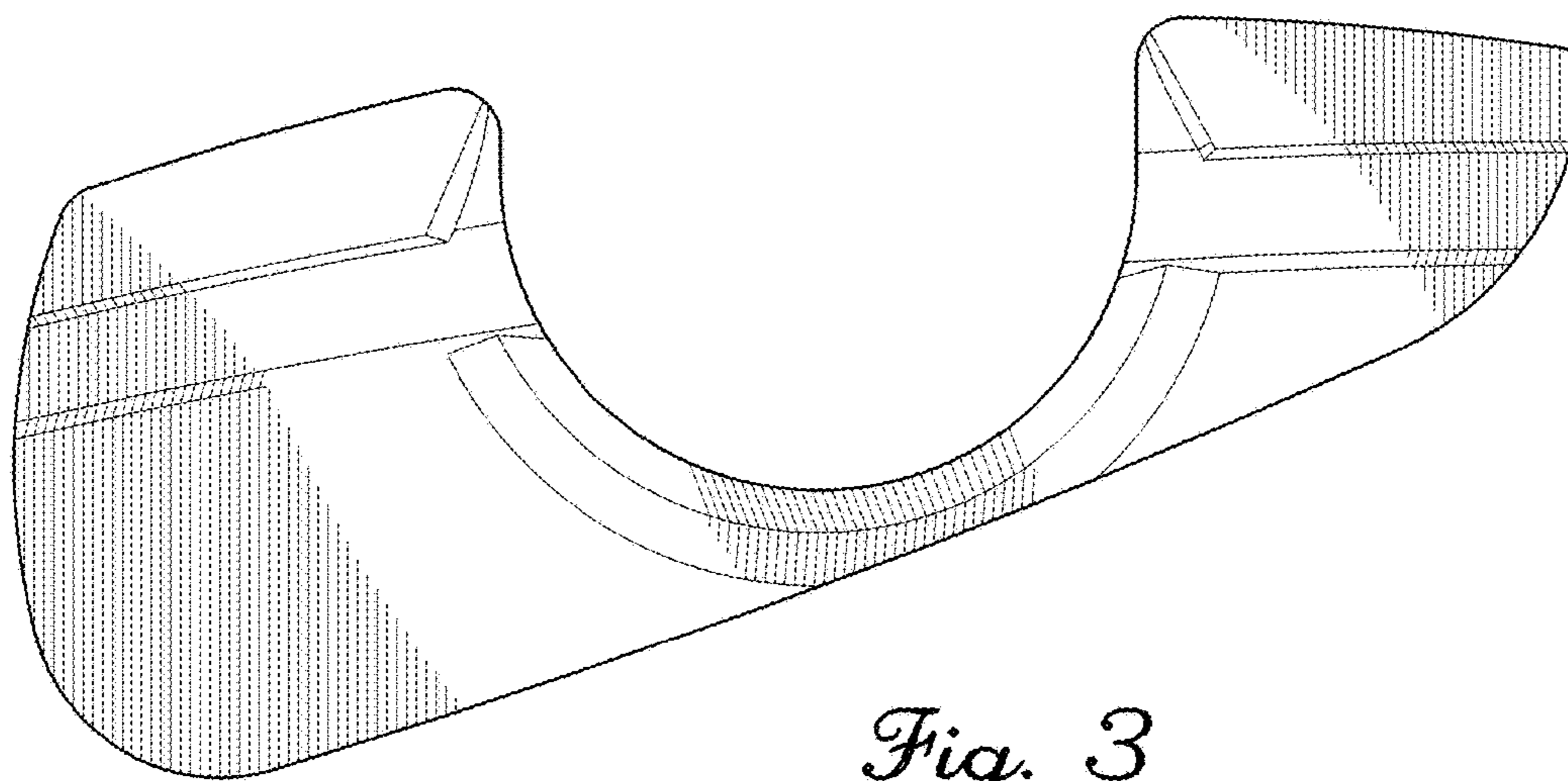

Fig. 3

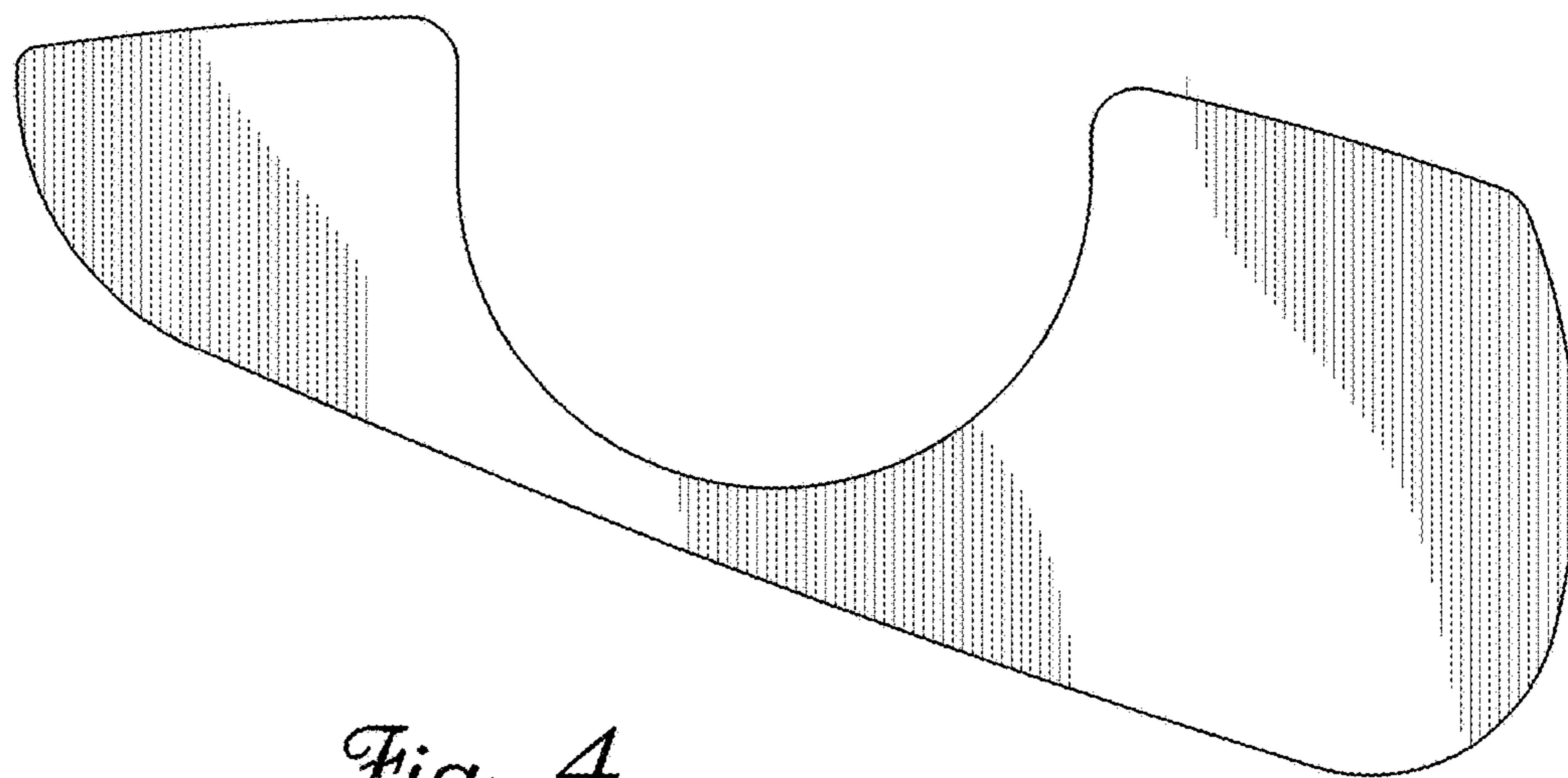

Fig. 4

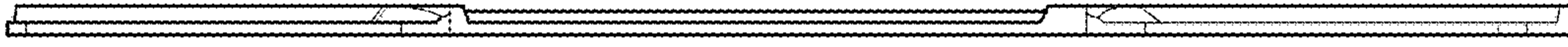

Fig. 5

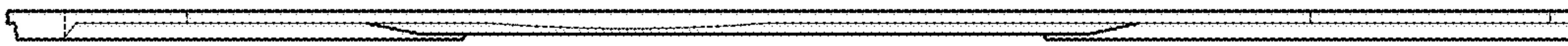

Fig. 6



Fig. 7



Fig. 8