



US00D780180S

(12) **United States Design Patent** (10) **Patent No.:** **US D780,180 S**
Ironmonger et al. (45) **Date of Patent:** **** Feb. 28, 2017**

(54) **GAMES CONTROLLER**
(71) Applicant: **Ironburg Inventions Ltd.**, Wincanton, Somerset (GB)
(72) Inventors: **Duncan Ironmonger**, Brookhaven, GA (US); **Carl S. Jeffrey**, Cheltenham (GB)

7,314,413 B2 * 1/2008 Ogata A63F 13/06
273/148 B
7,510,477 B2 3/2009 Argentar
7,854,655 B2 * 12/2010 Mao G06F 3/017
273/148 B
7,859,514 B1 12/2010 Park
D638,017 S * 5/2011 Ortiz D14/401
D667,892 S * 9/2012 Burgess D21/333
(Continued)

(73) Assignee: **Ironburg Inventions Ltd.**, Wincanton (GB)

FOREIGN PATENT DOCUMENTS

(**) Term: **15 Years**

EP 2 479 636 7/2012
EP 2 698 185 2/2015
(Continued)

(21) Appl. No.: **29/556,666**

OTHER PUBLICATIONS

(22) Filed: **Mar. 2, 2016**

Burns, "Review: Scut Xbox 360 Controller," Xboxer360.com (2010).

(51) **LOC (10) Cl.** **14-03**

(52) **U.S. Cl.**
USPC **D14/401; D21/333**

(Continued)

(58) **Field of Classification Search**
USPC D14/496, 401, 435, 474, 483, 217, 137, D14/138, 160, 168, 356, 203.1-203.8, D14/507; 345/156, 169, 173-179, 905; 715/727-729, 864, 700, 706, 719; 710/1, 710/5, 8; 713/1, 600; 455/1.1, 1.7, 73, 455/344-347, 93, 95, 3.01-3.06, 550.1, 455/573.1; 370/342-344; 369/1, 2, 6-12; 463/40-47, 51-57, 1, 29-35; D21/324, D21/328, 333; 273/148 B
CPC A63F 13/00; A63F 13/02; A63F 9/00; G06F 17/00; G06F 19/00
See application file for complete search history.

Primary Examiner — Prabhakar Deshmukh
(74) *Attorney, Agent, or Firm* — Walters & Wasylyna LLC

(57) **CLAIM**

The ornamental design for a games controller, as shown and described.

DESCRIPTION

FIG. 1 is a perspective view of a games controller in accordance with the present design;
FIG. 2 is a front view of the games controller of FIG. 1;
FIG. 3 is a rear view of the games controller of FIG. 1;
FIG. 4 is a bottom view of the games controller of FIG. 1;
FIG. 5 is a top view of the games controller of FIG. 1;
FIG. 6 is a left side view of the games controller of FIG. 1; and,
FIG. 7 is a right side view of the games controller of FIG. 1.

(Continued)

(56) **References Cited**

U.S. PATENT DOCUMENTS

6,171,191 B1 * 1/2001 Ogata A63F 13/06
273/148 B
6,231,444 B1 * 5/2001 Goto G05G 9/047
273/148 B
6,251,015 B1 6/2001 Caprai
6,572,108 B1 * 6/2003 Bristow A63F 13/06
273/148 B

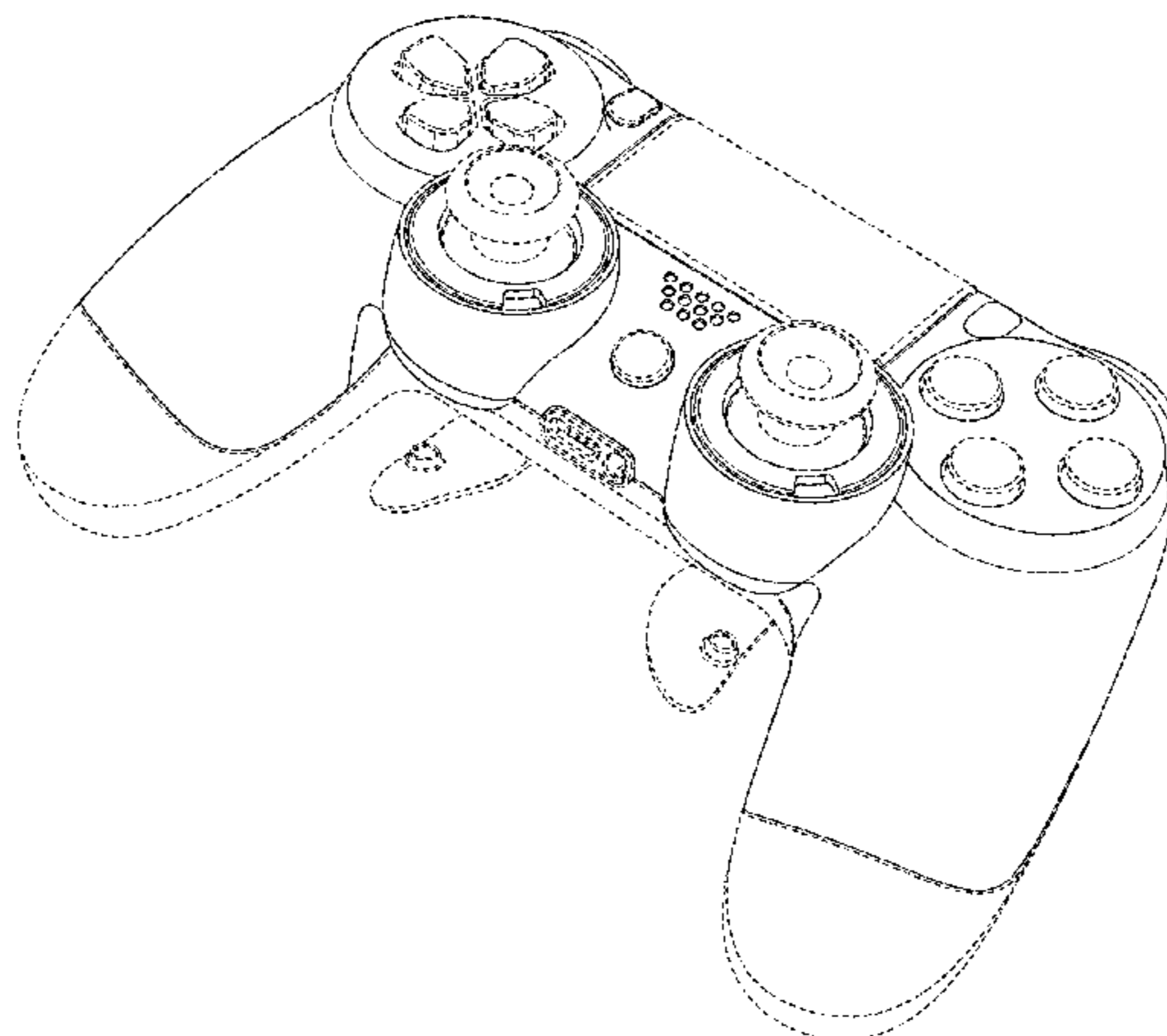

The broken lines in the drawings show environment that forms no part of the claimed design.

1 Claim, 7 Drawing Sheets

2009/0258705	A1	10/2009	Guinchard
2010/0304865	A1	12/2010	Picunko
2011/0256930	A1	10/2011	Jaouen
2011/0281649	A1	11/2011	Jaouen
2012/0322553	A1	12/2012	Burgess et al.
2014/0274397	A1	9/2014	Sebastian
2015/0238855	A1	8/2015	Uy et al.

(56)

References Cited

U.S. PATENT DOCUMENTS

8,641,525	B2 *	2/2014	Burgess	A63F 13/24 200/329
D715,296	S *	10/2014	Huang	D14/401
D733,802	S *	7/2015	Burgess	D14/401
D748,734	S *	2/2016	Burgess	D21/333
D766,375	S *	9/2016	Kujawski	D14/401
2001/0003713	A1	6/2001	Willner et al.		
2002/0052237	A1	5/2002	Magill		
2002/0128064	A1	9/2002	Sobota		
2003/0067111	A1	4/2003	Swan		
2004/0259059	A1	12/2004	Aoki		
2005/0083297	A1	4/2005	Duncan		
2005/0255918	A1	11/2005	Riggs et al.		
2009/0088250	A1	4/2009	Carlson		

FOREIGN PATENT DOCUMENTS

GB	2 244 546	12/1991
GB	2 481 633	1/2012
WO	WO 2008/131249	10/2008

OTHER PUBLICATIONS

“Rapid Fire Mod for Wireless Xbox 360 Controller,” forum on xbox-scene.com, (2008).
 “Thrustmaster USB game controller roundup,” dansdata.com/tmsticks.htm (2002).
 Coles, Olin, “Thrustmaster Run-N-Drive PC/PS3 Wireless Gamepad” BenchmarkReviews.com (2009).

* cited by examiner

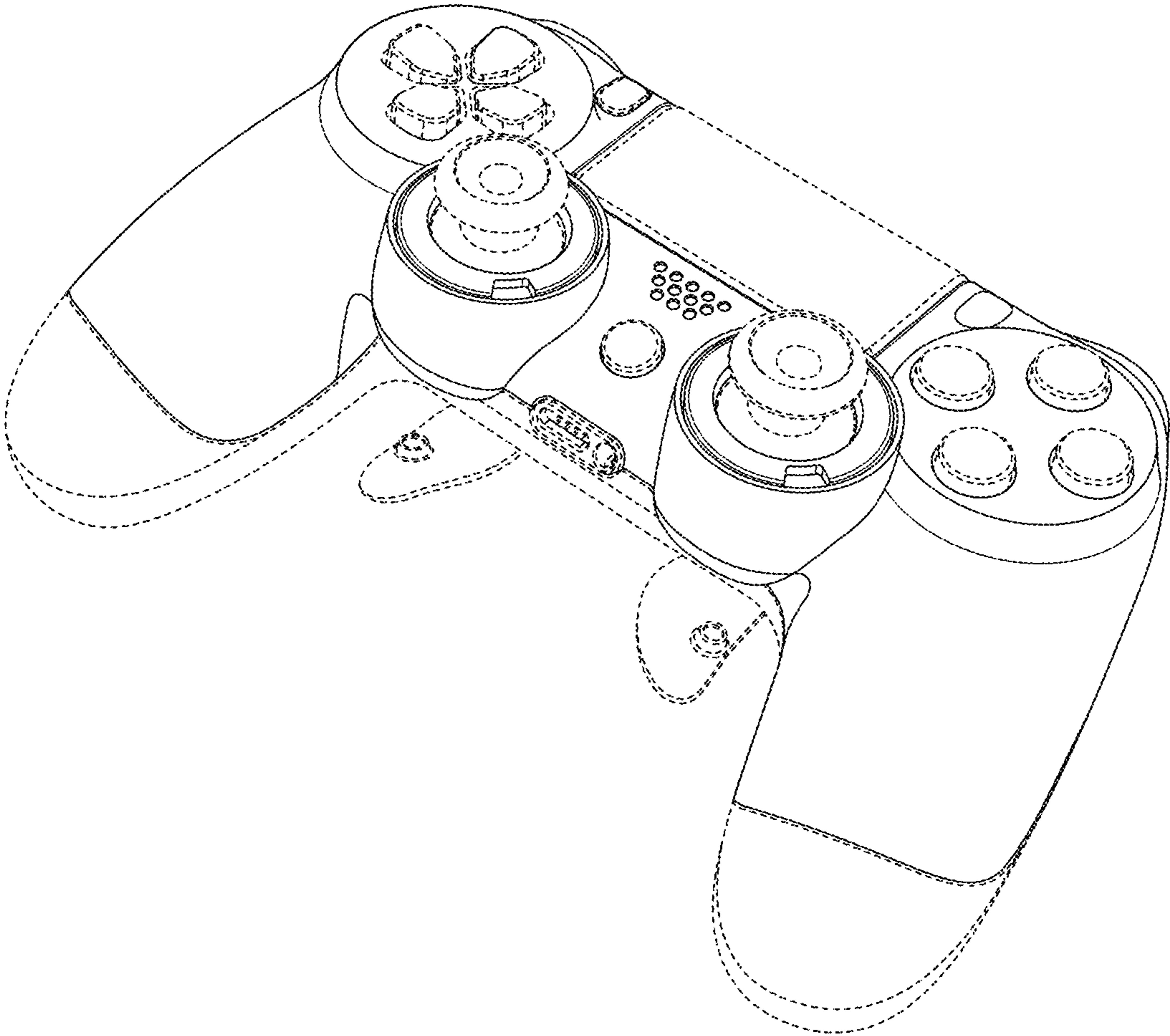

FIG. 1

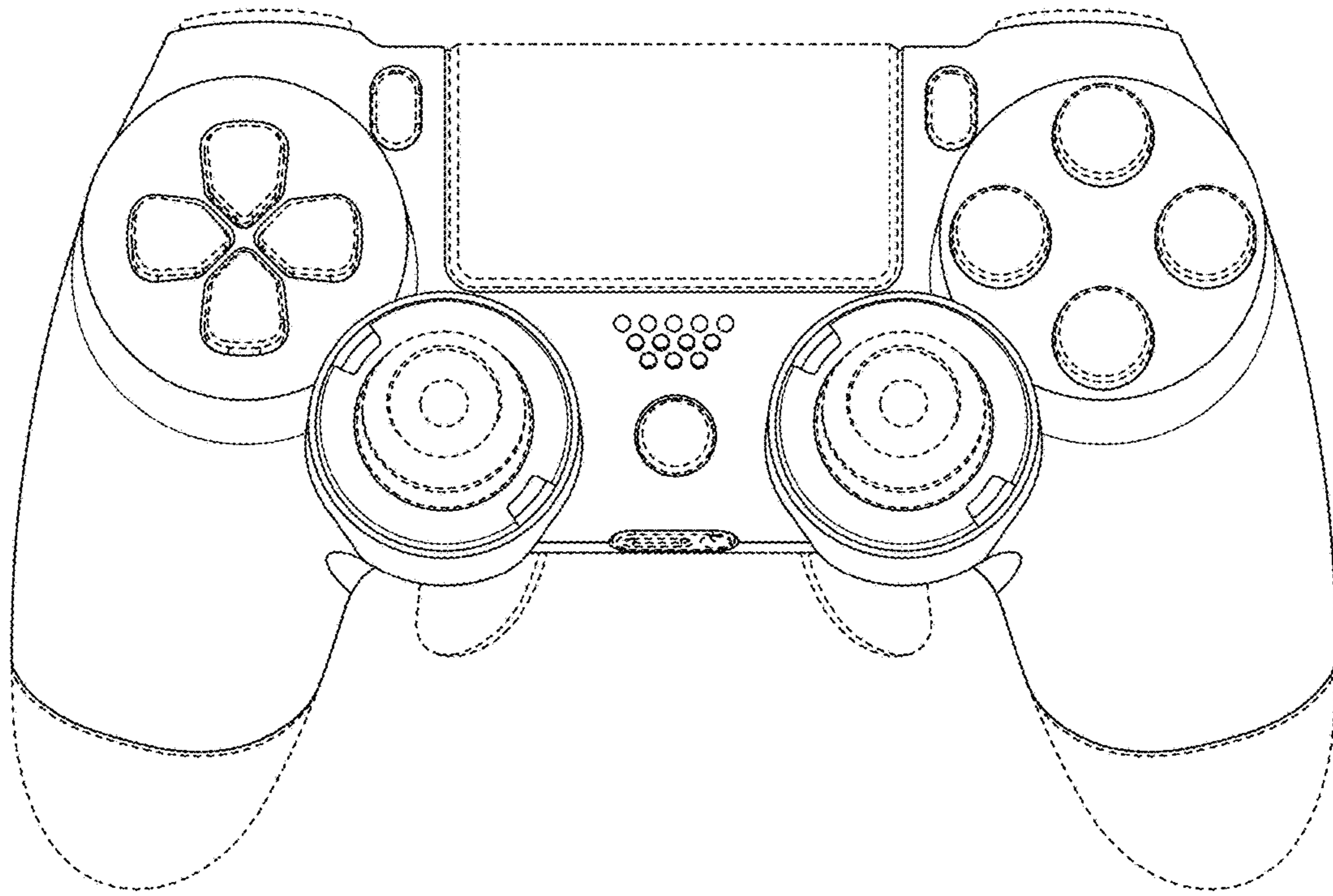

FIG. 2

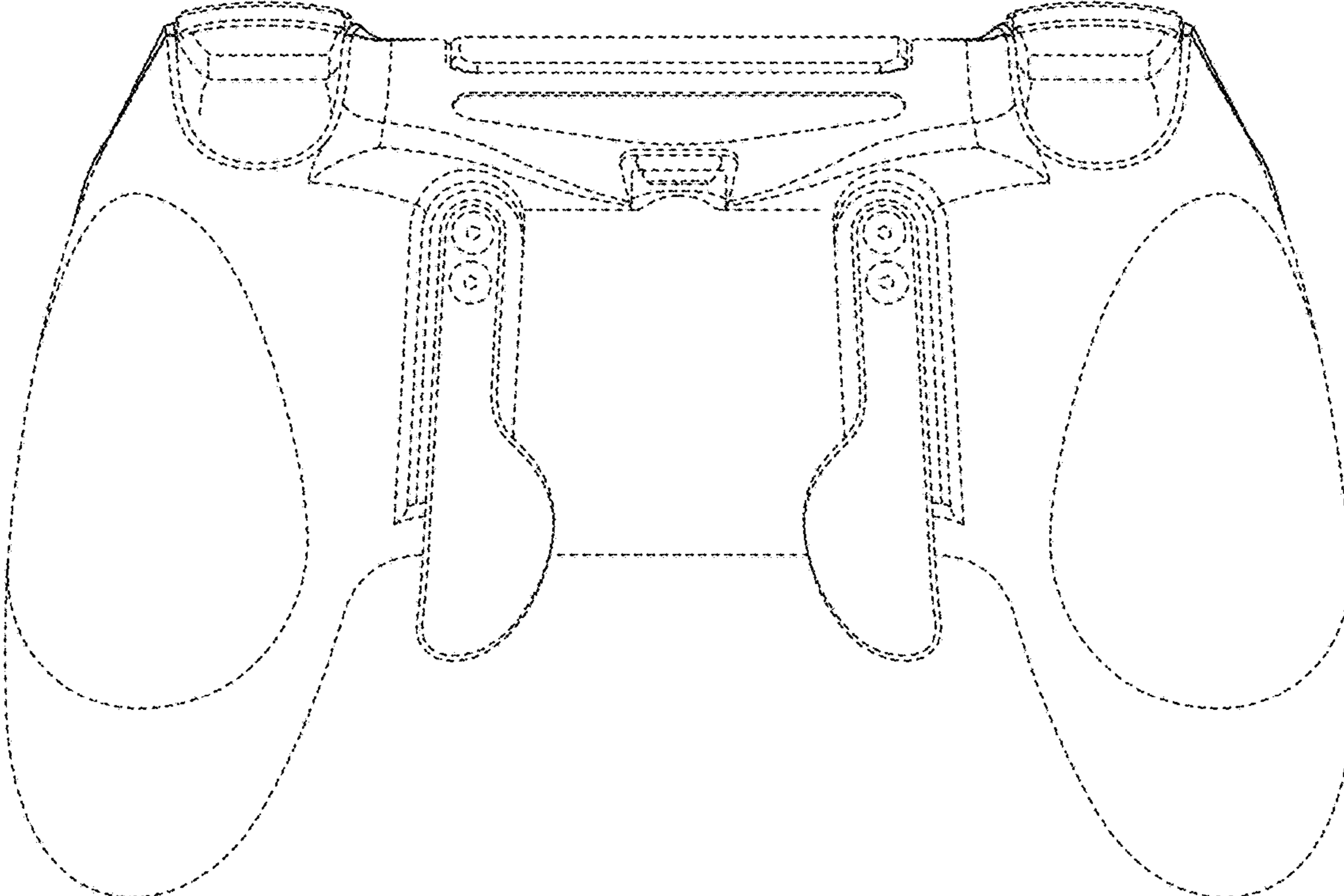

FIG. 3

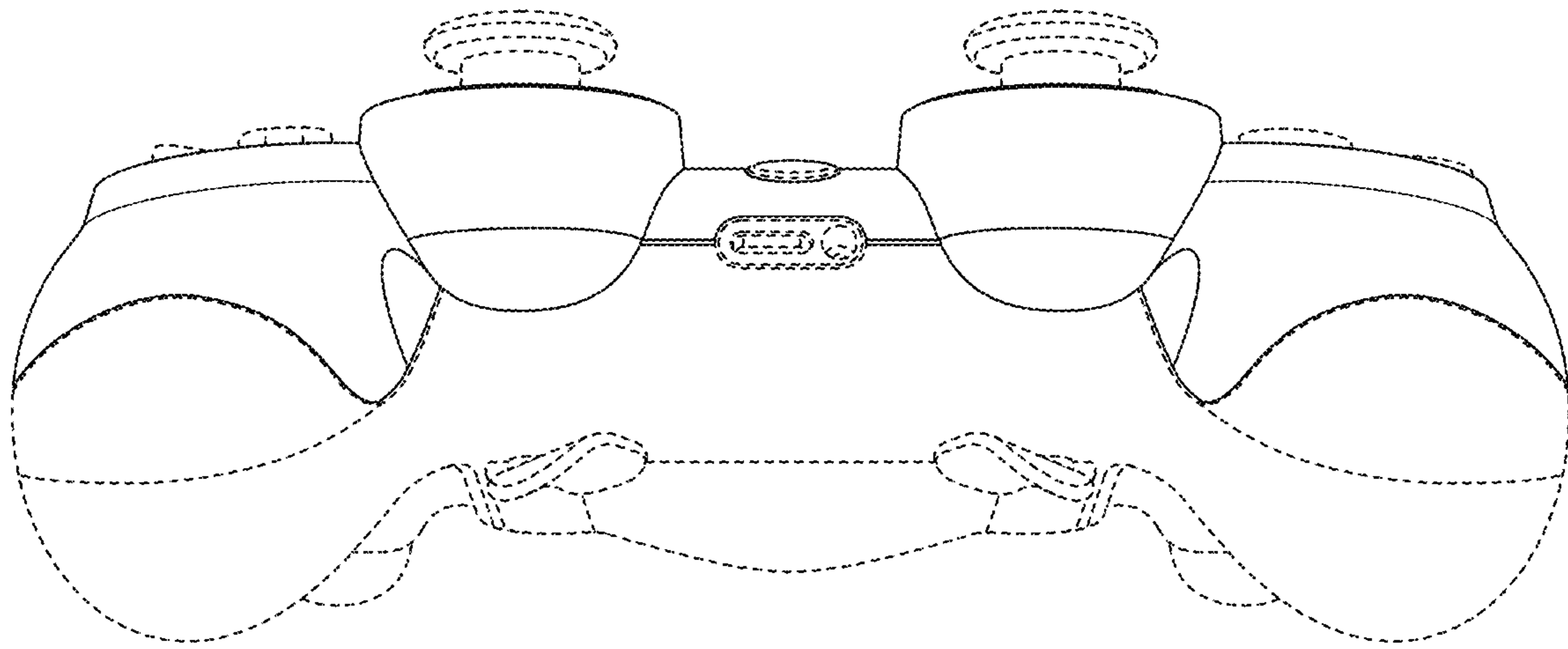

FIG. 4

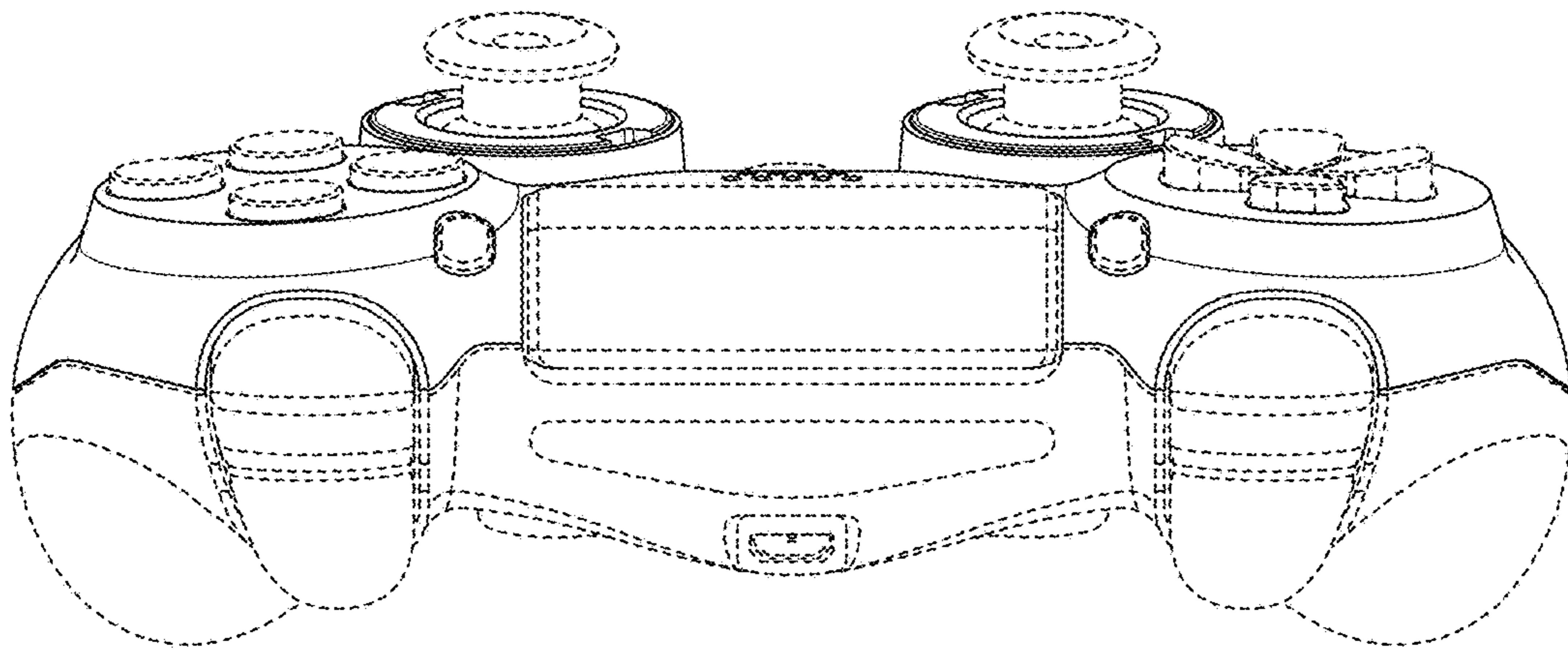

FIG. 5

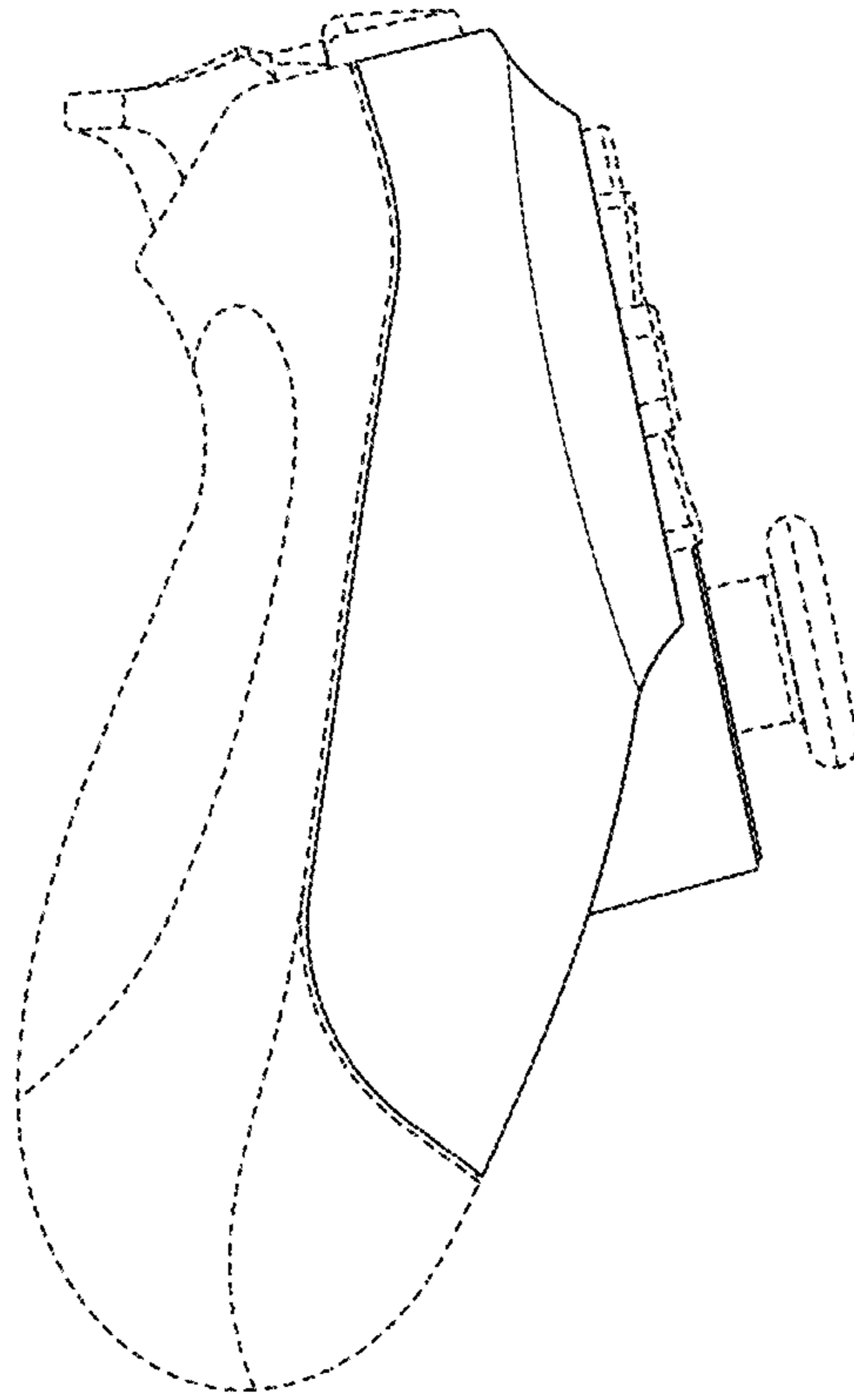

FIG. 6

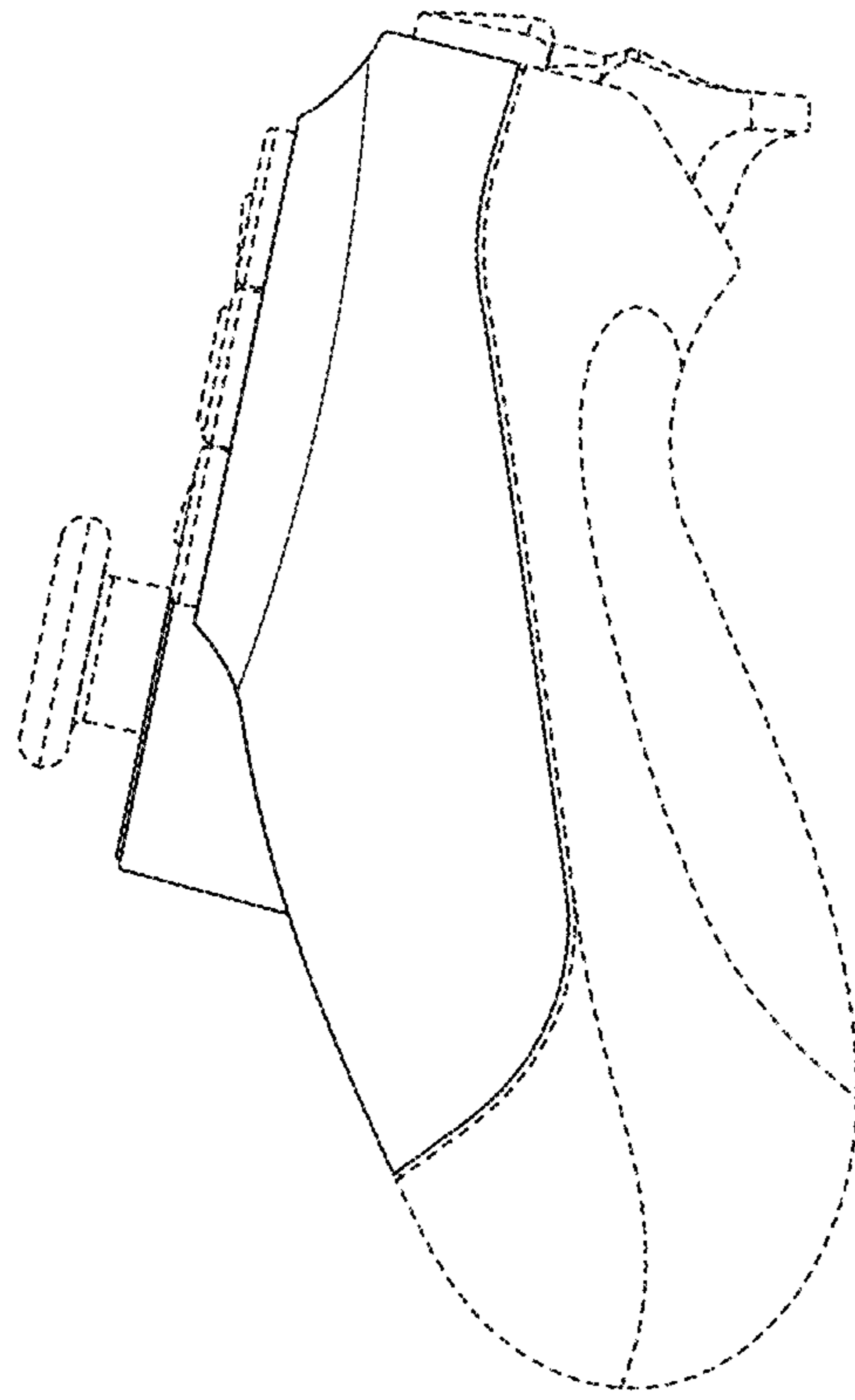

FIG. 7