



US00D780042S

(12) **United States Design Patent** (10) **Patent No.:** **US D780,042 S**
Bibeault et al. (45) **Date of Patent:** **** Feb. 28, 2017**

(54) **TAG**

(71) Applicant: **Jostens, Inc.**, Minneapolis, MN (US)

(72) Inventors: **John Bibeault**, Flower Mound, TX (US); **Miran Armutlu**, Lorraine (CA);
Ann M. Carr, Hopkins, MN (US);
Timothy D. Saarela, Prior Lake, MN (US); **Kelly L. Karsky**, Savage, MN (US);
Safak Cinar, Saint Laurent (CA); **John A. Freiberg**, New Brighton, MN (US);
Blaine Stewart, Medford, MN (US)

(73) Assignee: **Jostens, Inc.**, Minneapolis, MN (US)

(**) Term: **14 Years**

(21) Appl. No.: **29/518,208**

(22) Filed: **Feb. 20, 2015**

(51) **LOC (10) Cl.** **11-01**

(52) **U.S. Cl.**
USPC **D11/79**

(58) **Field of Classification Search**
USPC D11/1, 2, 7, 8, 40-48, 79-86, 90, 91, 92,
D11/93; D3/207-211

(Continued)

(56) **References Cited**

U.S. PATENT DOCUMENTS

144,153 A * 10/1873 Smith A44C 3/00
63/18
2,176,253 A * 10/1939 Fogarty A45C 13/42
40/661.06

(Continued)

OTHER PUBLICATIONS

[Online] <http://www.jostens.com/jewelry/billboards/class-tags.jpg>.
Retrieved Sep. 15, 2016.*

(Continued)

Primary Examiner — Melanie Pellegrini

(74) *Attorney, Agent, or Firm* — Husch Blackwell LLP

(57) **CLAIM**

The ornamental design for an ornamental tag, as shown.

DESCRIPTION

FIG. 1 is a perspective view of an ornamental tag showing our new design;
FIG. 2 is a front view thereof;
FIG. 3 is a rear view thereof;
FIG. 4 is a left side view thereof;
FIG. 5 is a right side view thereof;
FIG. 6 is a top view thereof;
FIG. 7 is a bottom view thereof;
FIG. 8 is a perspective view of a second embodiment of an ornamental tag;
FIG. 9 is a front view thereof;
FIG. 10 is a rear view thereof;
FIG. 11 is a left side view thereof;
FIG. 12 is a right side view thereof;
FIG. 13 is a top view thereof;
FIG. 14 is a bottom view thereof;
FIG. 15 is a perspective view of a third embodiment of an ornamental tag;
FIG. 16 is a front view thereof;
FIG. 17 is a rear view thereof;
FIG. 18 is a left side view thereof;
FIG. 19 is a right side view thereof;
FIG. 20 is a top view thereof;
FIG. 21 is a bottom view thereof;
FIG. 22 is a perspective view of a fourth embodiment of an ornamental tag;
FIG. 23 is a front view thereof;
FIG. 24 is a rear view thereof;
FIG. 25 is a left side view thereof;
FIG. 26 is a right side view thereof;
FIG. 27 is a top view thereof;
FIG. 28 is a bottom view thereof;
FIG. 29 is a perspective view of a fifth embodiment of an ornamental tag;
FIG. 30 is a front view thereof;
FIG. 31 is a rear view thereof;

(Continued)

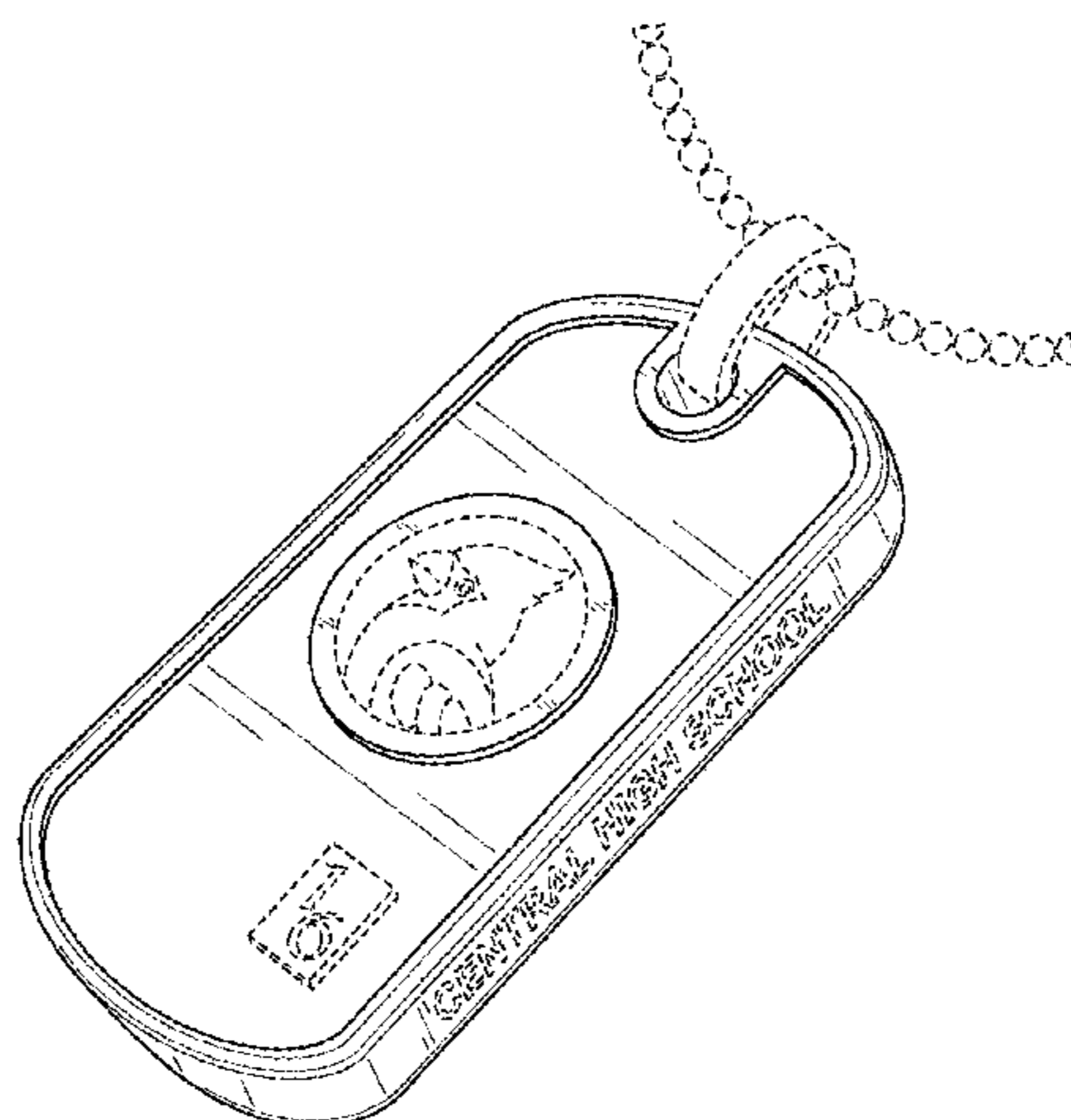

FIG. 32 is a left side view thereof;
 FIG. 33 is a right side view thereof;
 FIG. 34 is a top view thereof; and,
 FIG. 35 is a bottom view thereof.

The broken lines showing a chain and jump ring represent environment and the remaining broken lines in the drawings represent portions of the ornamental tag which form no part of the claimed design.

1 Claim, 25 Drawing Sheets

(58) **Field of Classification Search**

CPC .. A44C 1/00; A44C 3/00; A44C 3/004; A44C 3/005; A44C 3/007; A44C 3/008; A44C 5/02; A44C 7/002; A44C 25/00; A44C 25/001; A44C 25/002; A44C 25/004; A44C 25/005; A44C 25/007

See application file for complete search history.

(56) **References Cited**

U.S. PATENT DOCUMENTS

2,297,285 A * 9/1942 Bledsoe A44B 15/005
 40/634
 D221,118 S * 7/1971 Chambers D20/22
 D249,339 S * 9/1978 Coulthurst D11/79
 D260,861 S * 9/1981 Han D11/79
 D262,895 S * 2/1982 Szabo D19/10
 D266,555 S * 10/1982 McNally D11/80
 D291,897 S * 9/1987 Flies D20/22
 4,789,573 A * 12/1988 Jenkinson A44B 15/005
 40/330
 D310,600 S * 9/1990 Holterscheidt D3/207
 5,511,390 A * 4/1996 Mah A44C 25/00
 206/37.1

D380,979 S * 7/1997 Perlmutter D10/30
 D395,845 S * 7/1998 Hickbert D11/95
 D542,024 S * 5/2007 Bulgari D3/207
 D543,888 S * 6/2007 Bulgari D11/79
 D545,166 S * 6/2007 Laaper D14/480.3
 D554,363 S * 11/2007 Bates D3/207
 D566,603 S * 4/2008 Bulgari D11/7
 D569,760 S * 5/2008 Endres D11/95
 D571,855 S * 6/2008 Law D14/436
 D575,187 S * 8/2008 Mitchell D11/95
 D600,913 S * 9/2009 Kalbach D3/215
 D617,547 S * 6/2010 Mudrick D3/208
 D618,130 S * 6/2010 Polonye D11/80
 D619,919 S * 7/2010 Harding D11/80
 D622,710 S * 8/2010 Goransson D14/218
 D622,955 S * 9/2010 Mudrick D3/208
 D627,962 S * 11/2010 Mudrick D3/208
 D629,329 S * 12/2010 Mudrick D11/87
 D631,483 S * 1/2011 Nelson D14/484.1
 D633,410 S * 3/2011 Walsh D11/95
 D633,507 S * 3/2011 Nelson D14/484.1
 D640,866 S * 7/2011 Schmiemann D3/201
 D647,886 S * 11/2011 Kao D14/218
 D711,521 S * 8/2014 Irvin D23/366
 D712,894 S * 9/2014 Drexler D14/250
 D737,732 S * 9/2015 Stockett D12/120
 2009/0173104 A1 * 7/2009 Shunnarah A44C 3/007
 63/1.12

OTHER PUBLICATIONS

[Online] http://media.blingjewelry.com/media/catalog/product/cache/1/image/1200x/040ec09b1e35df139433887a97daa66f/s/i/silver-classic-dog-tag-pendant_cl-z8033_1.jpg. Retrieved Sep. 15, 2016.*

Pictures of tags compiled Jan. 2015 (3 pages), from Jostens.

* cited by examiner



FIG. 1

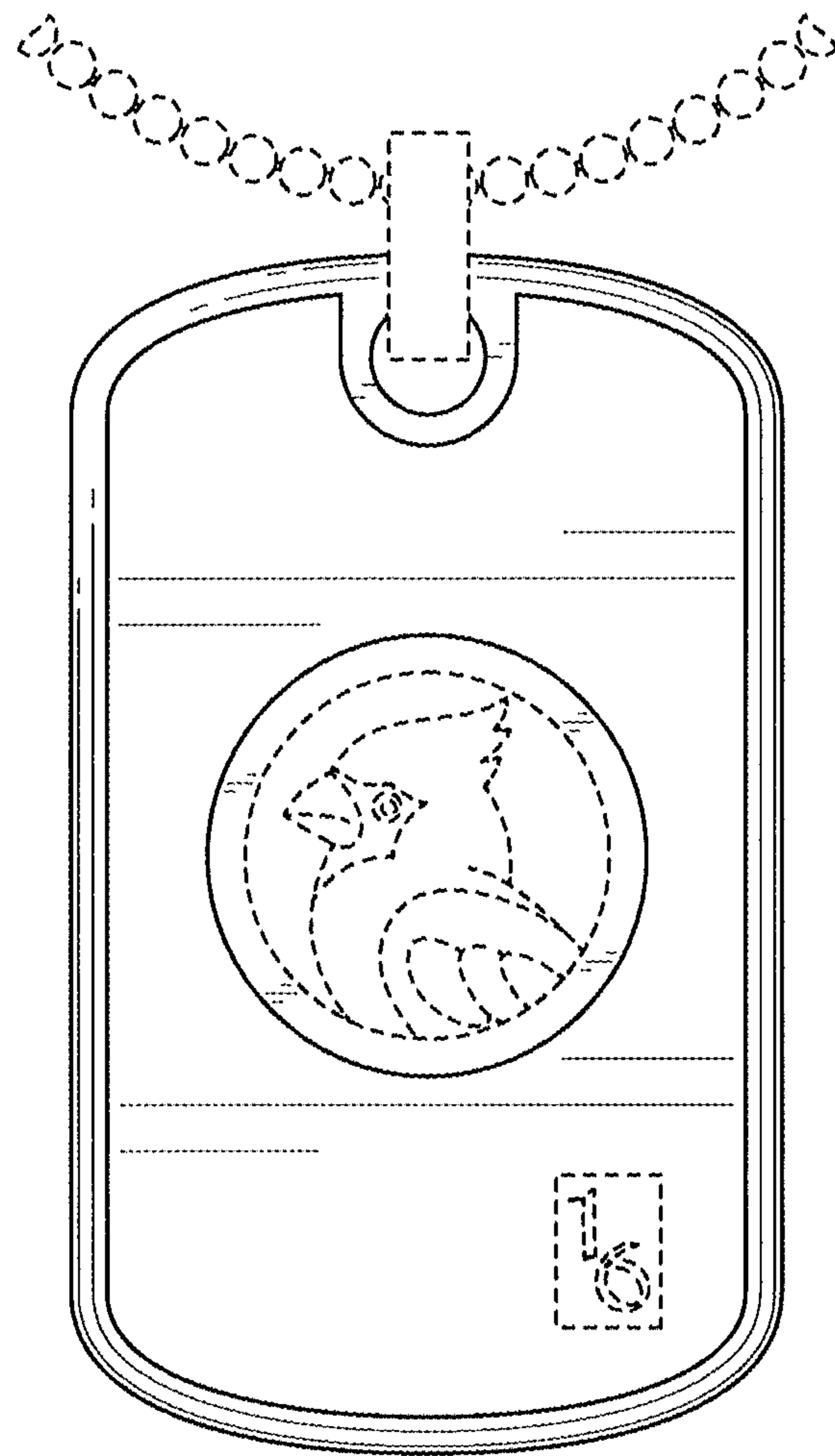

FIG. 2



FIG. 3

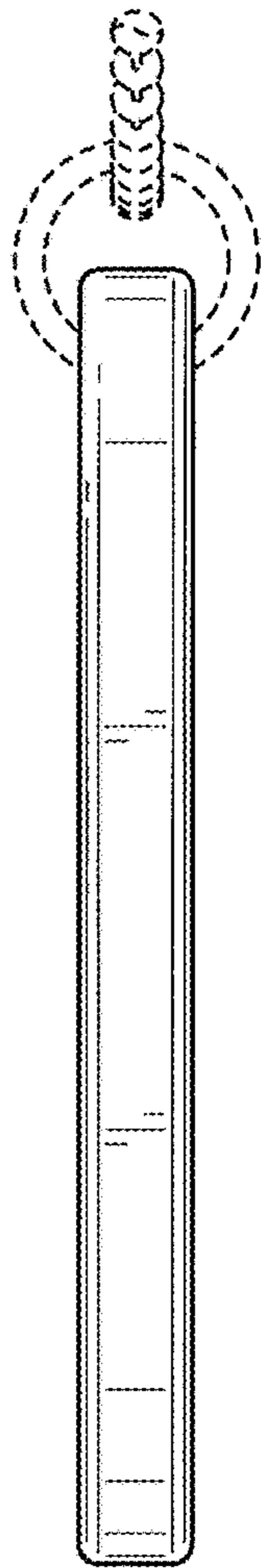

FIG. 4

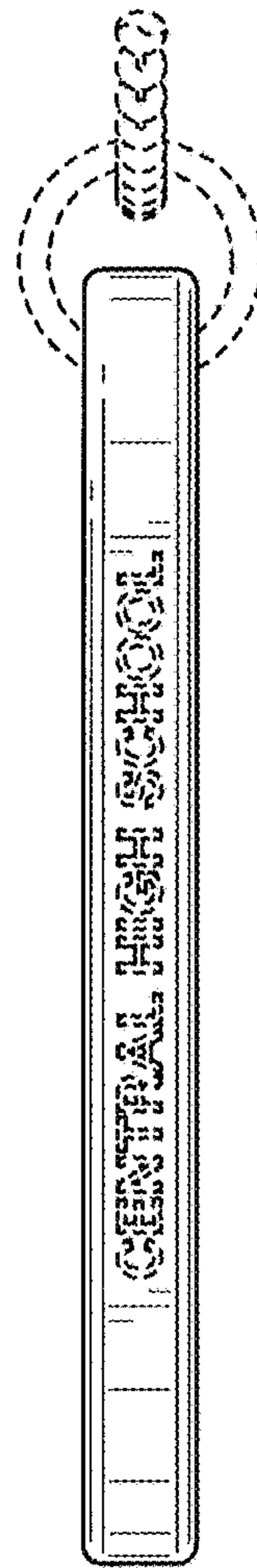

FIG. 5

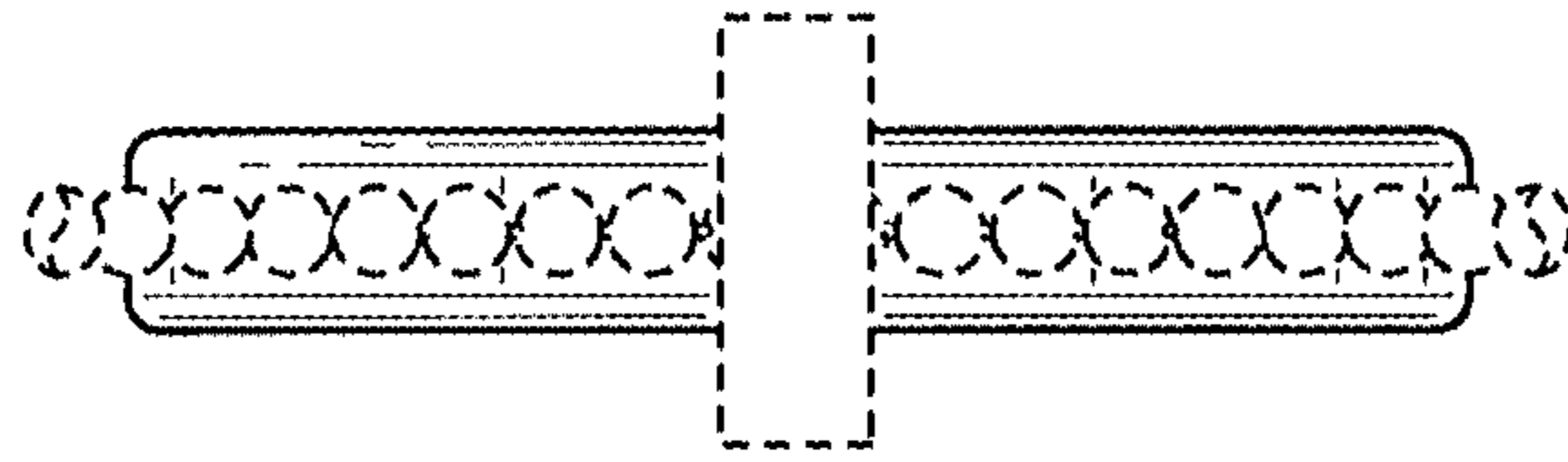

FIG. 6

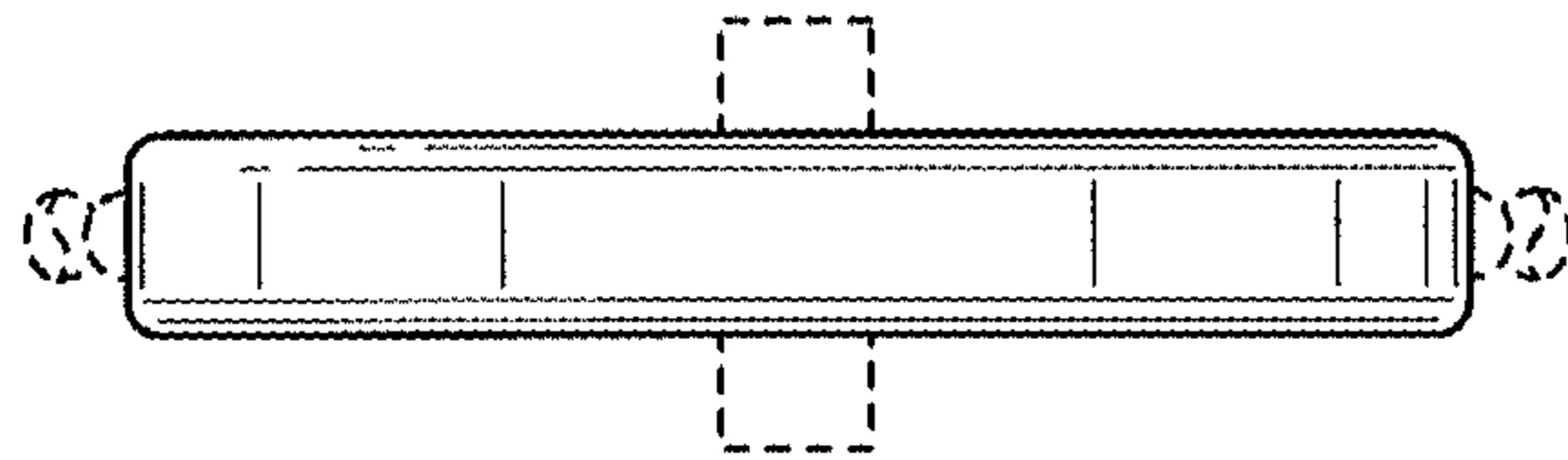

FIG. 7

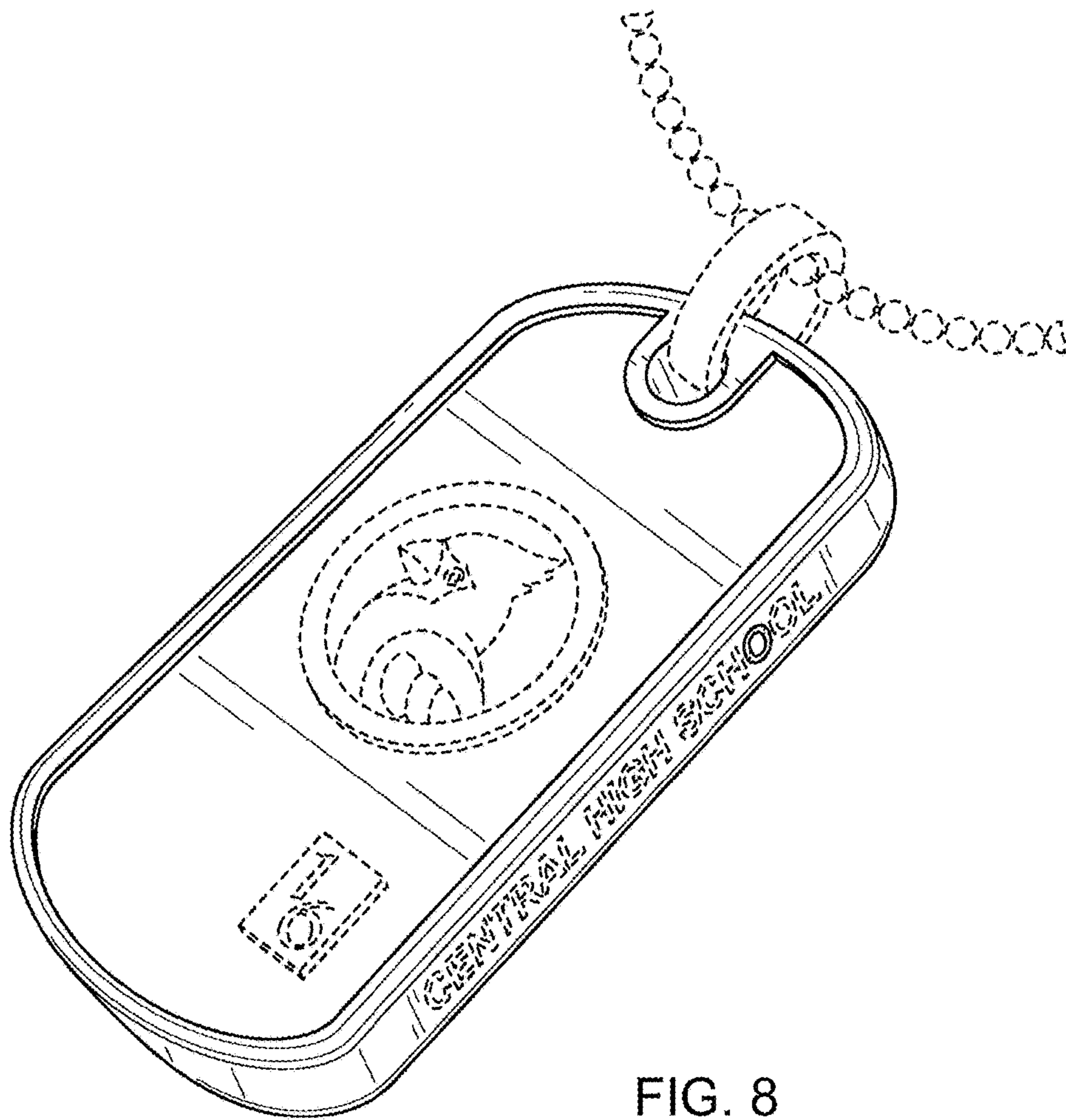

FIG. 8

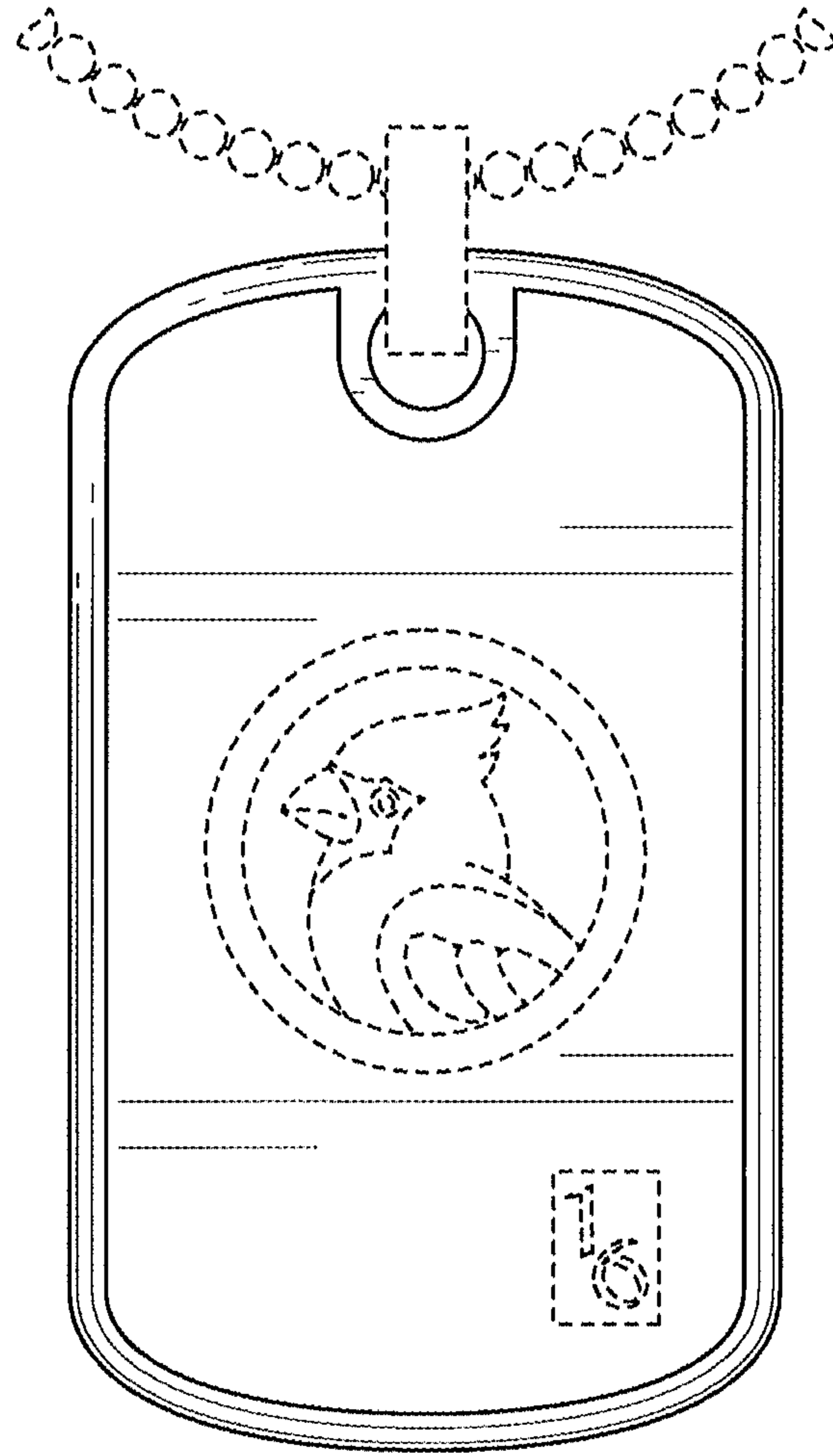

FIG. 9



FIG. 10

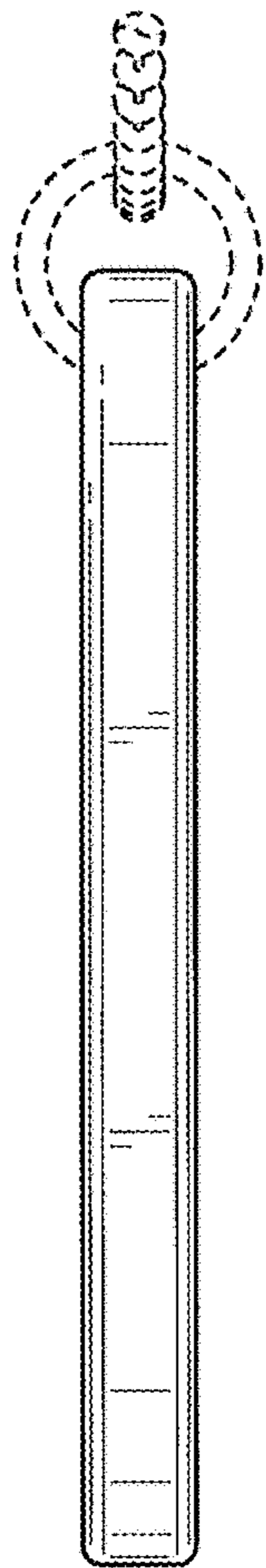

FIG. 11



FIG. 12

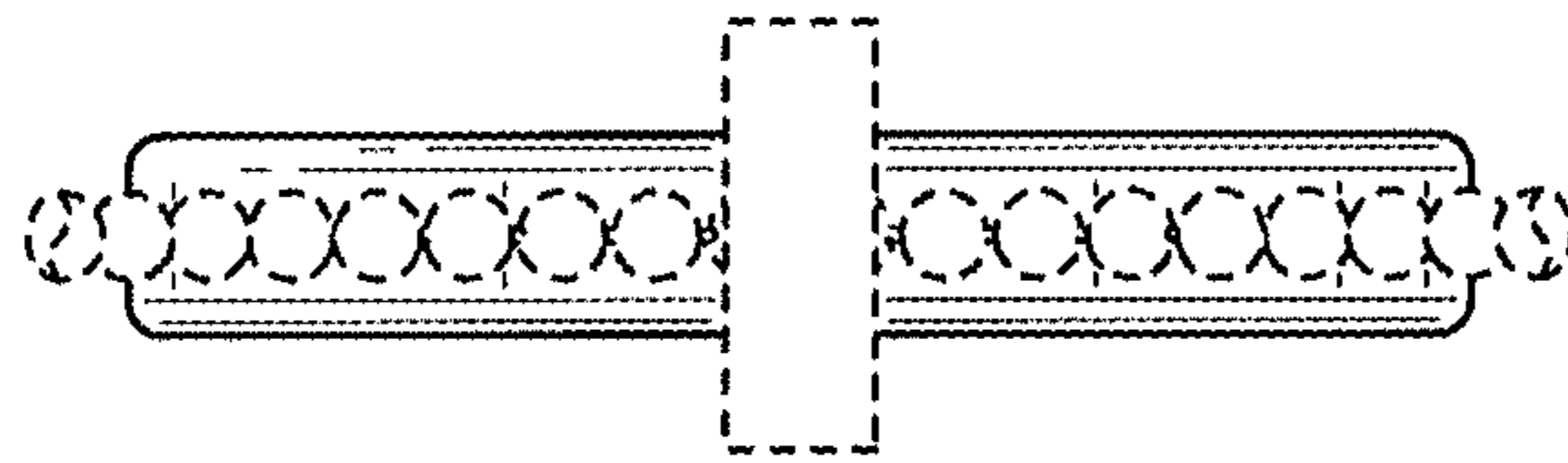

FIG. 13

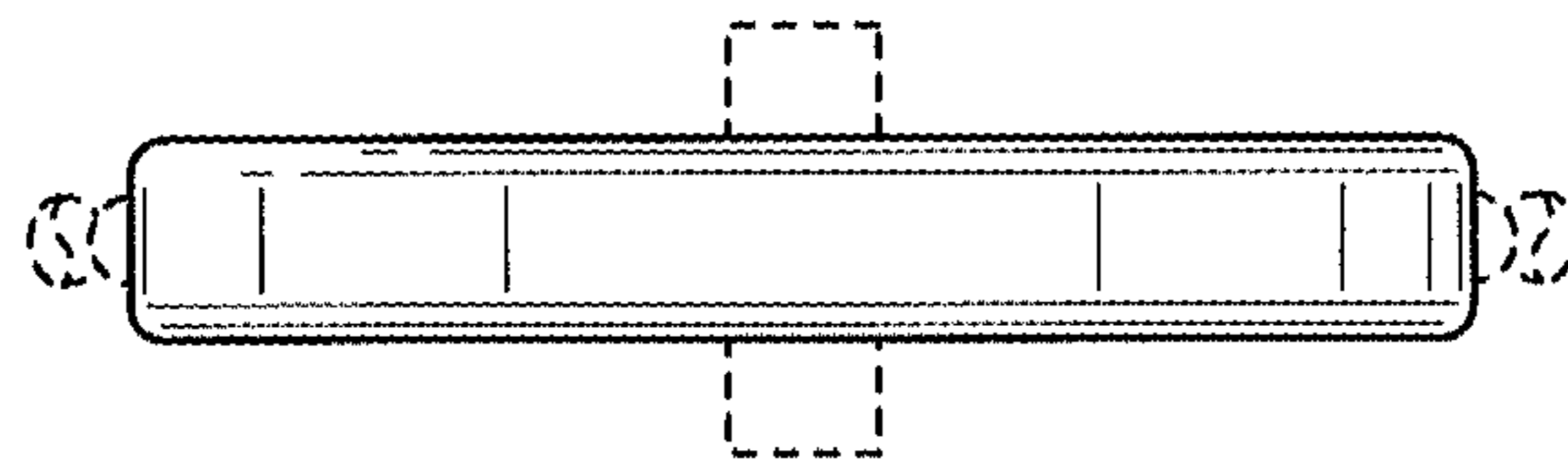

FIG. 14

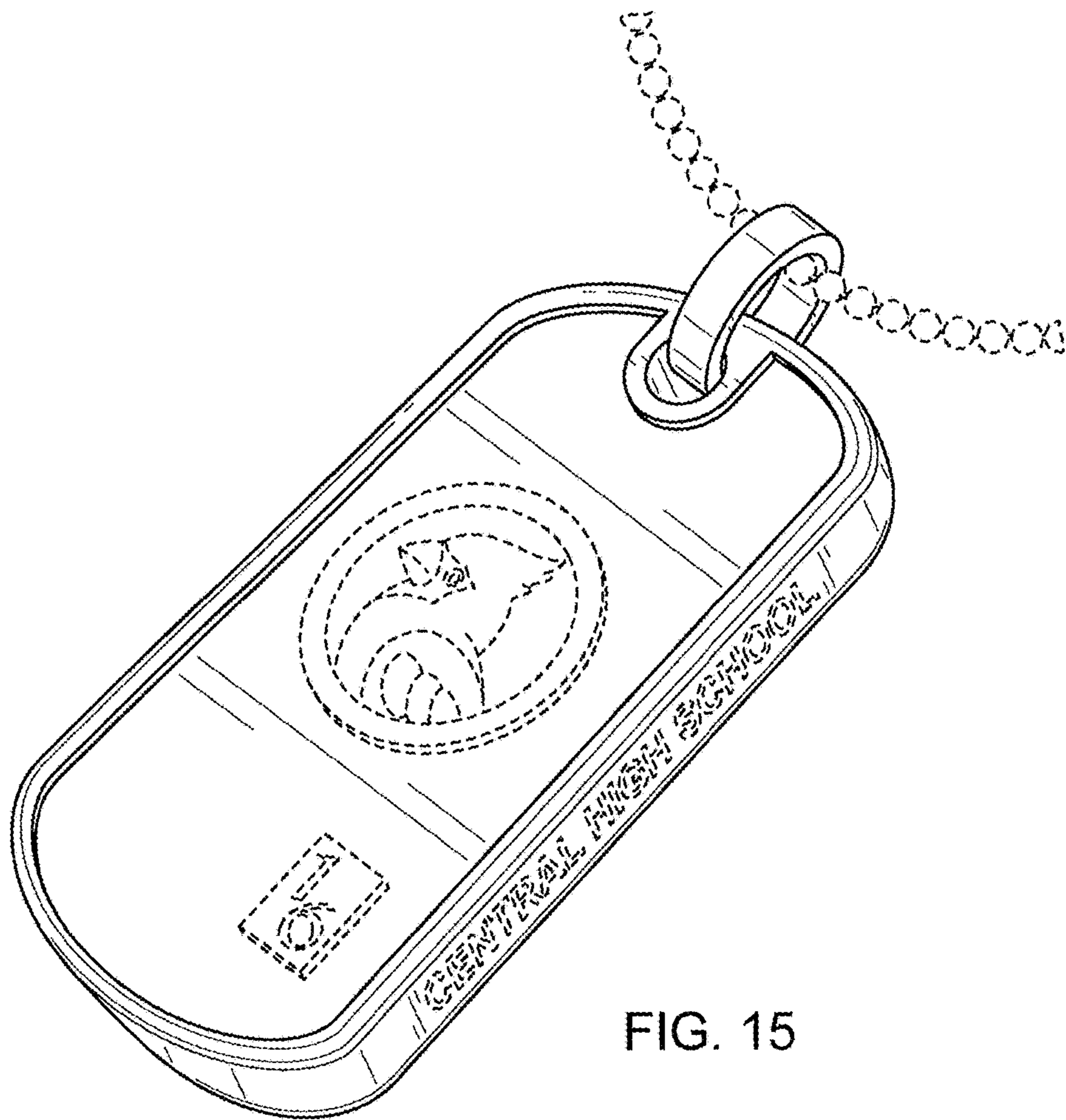

FIG. 15

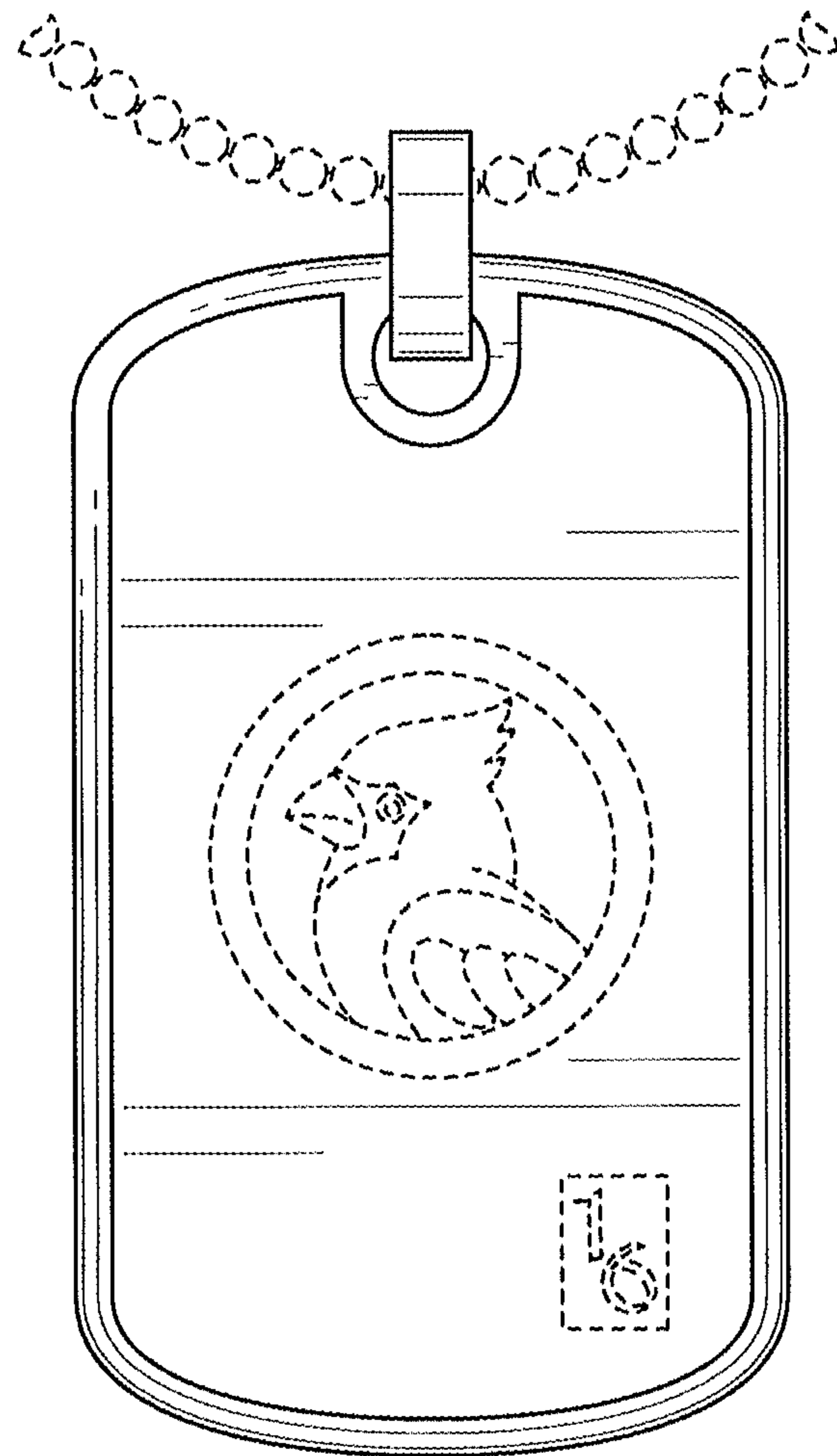

FIG. 16



FIG. 17

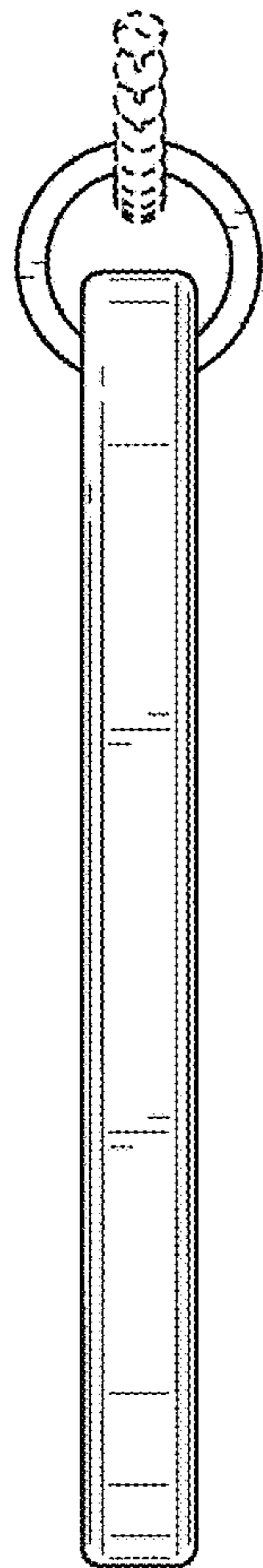

FIG. 18

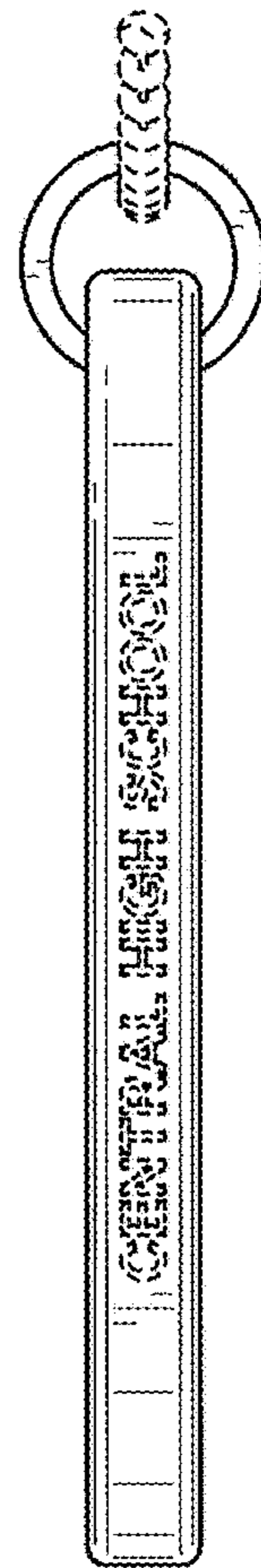

FIG. 19

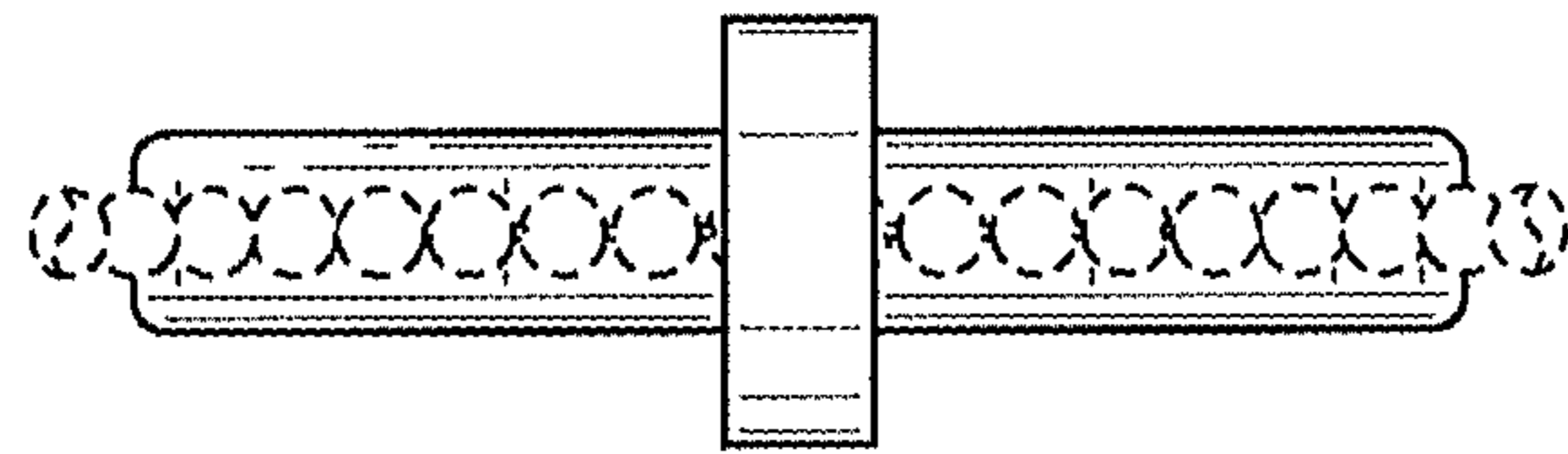

FIG. 20

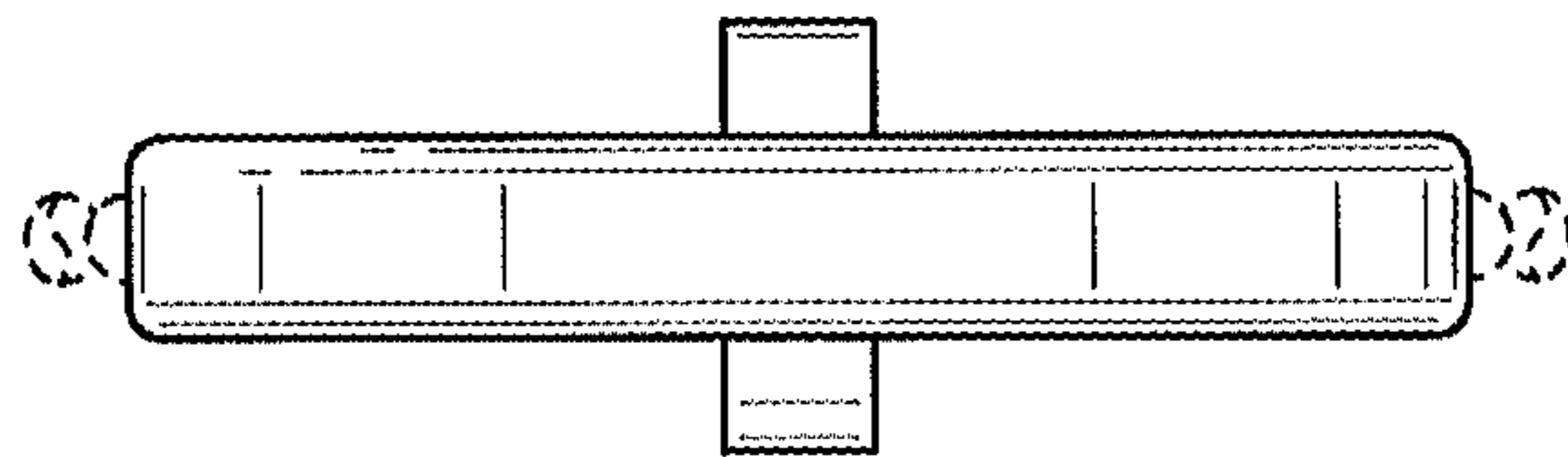

FIG. 21

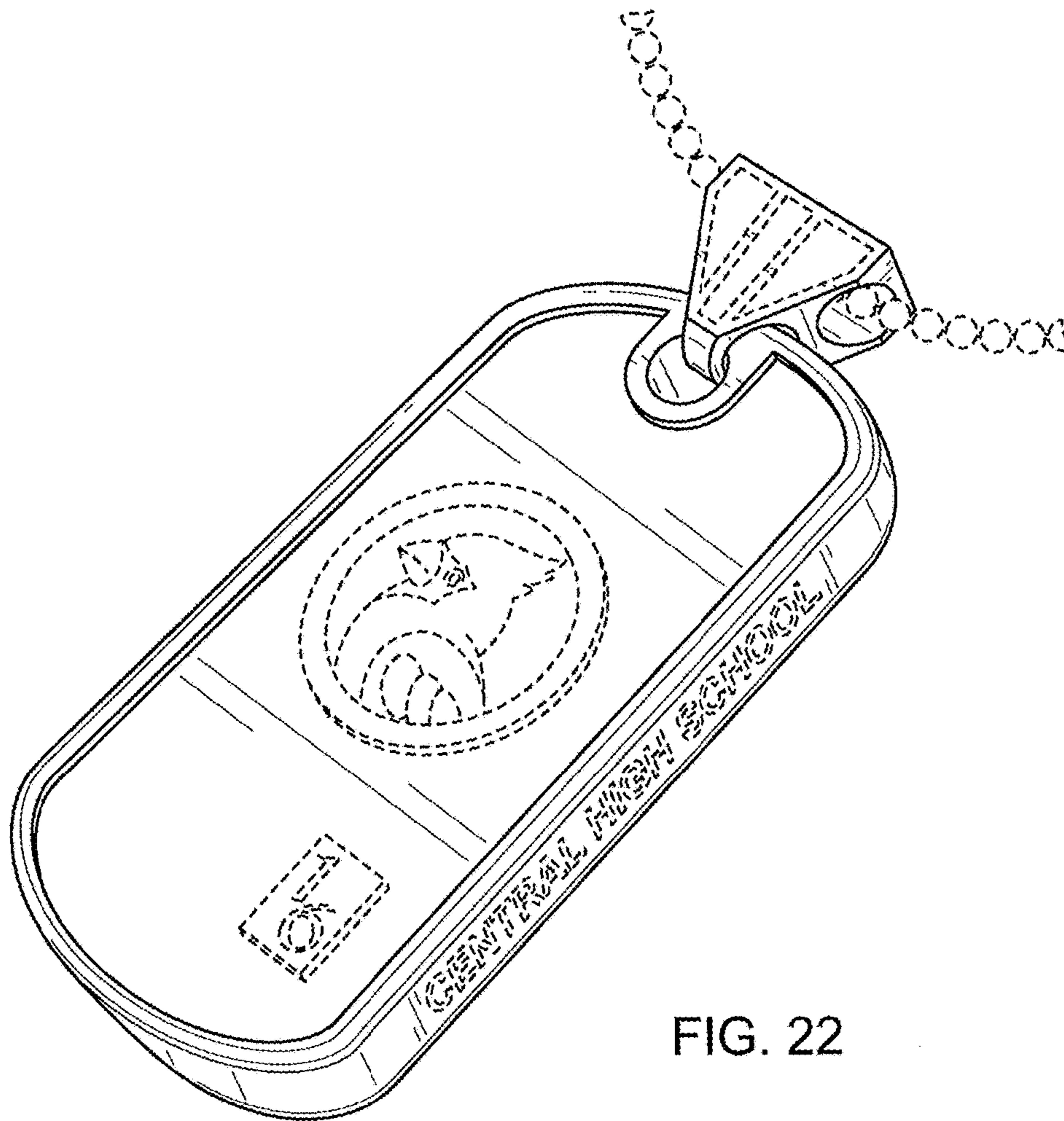

FIG. 22

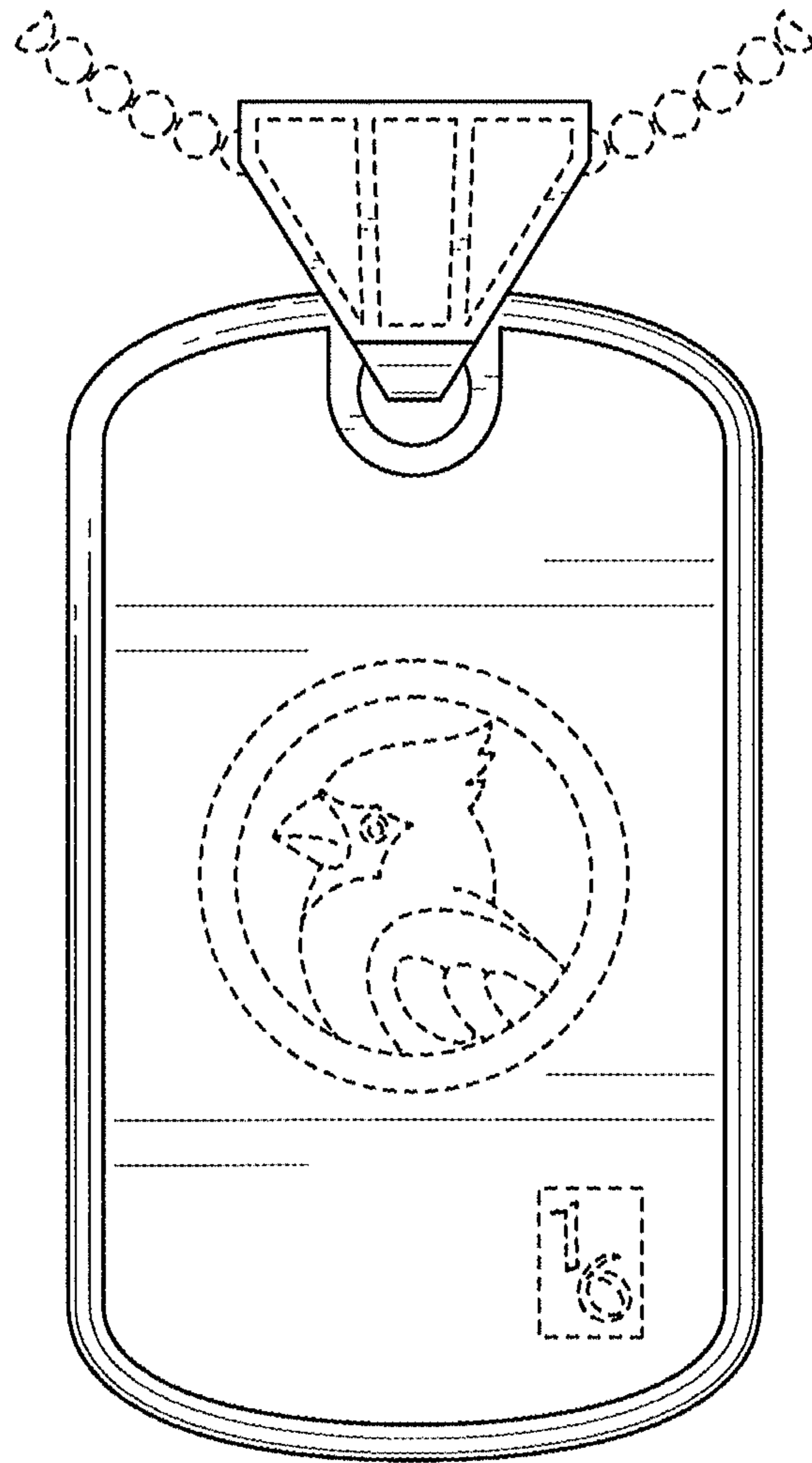

FIG. 23



FIG. 24

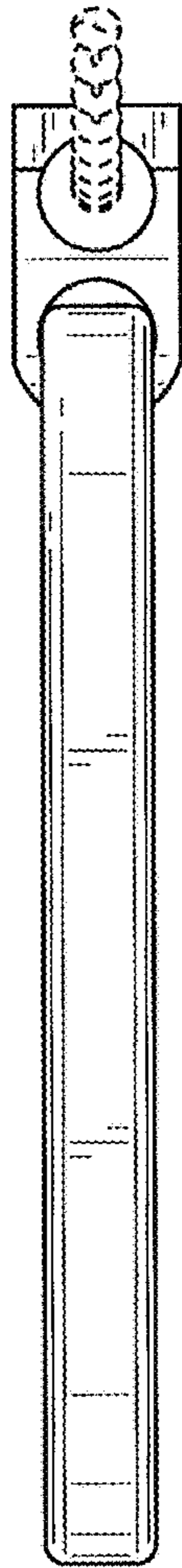

FIG. 25

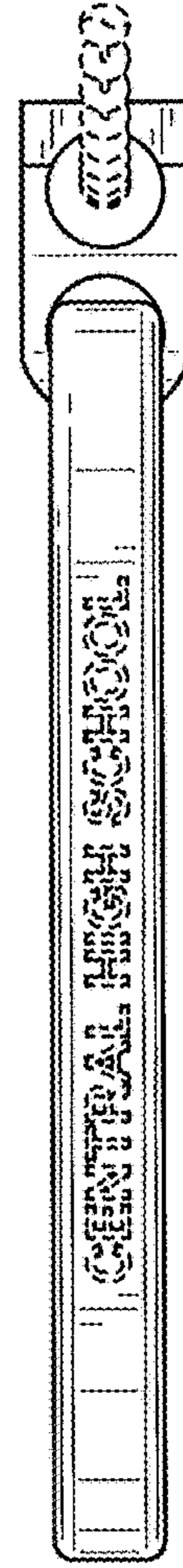

FIG. 26

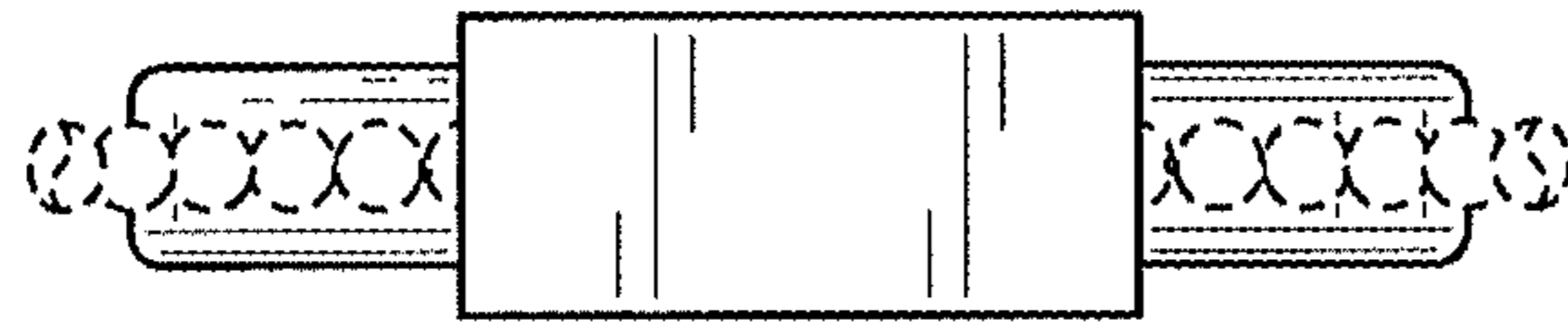

FIG. 27

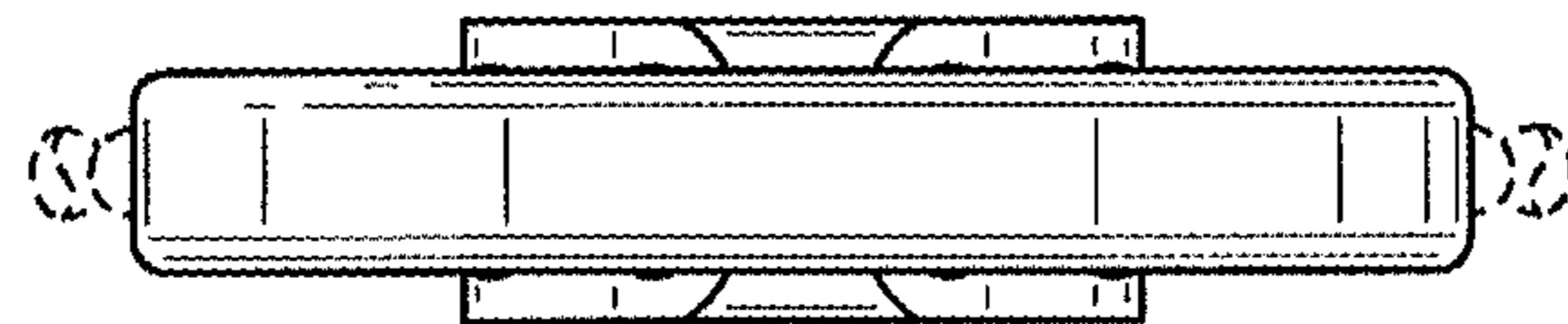

FIG. 28

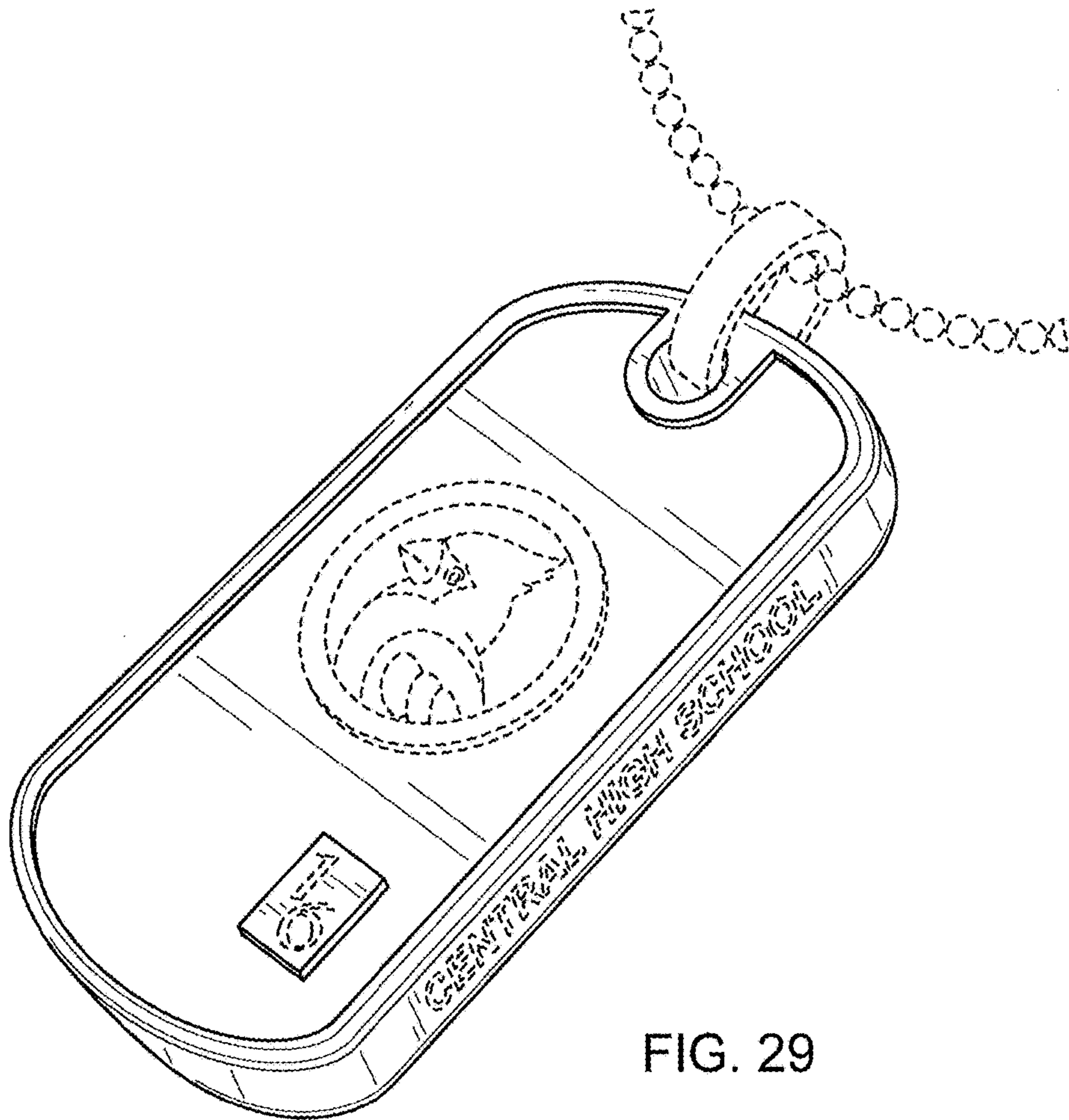

FIG. 29

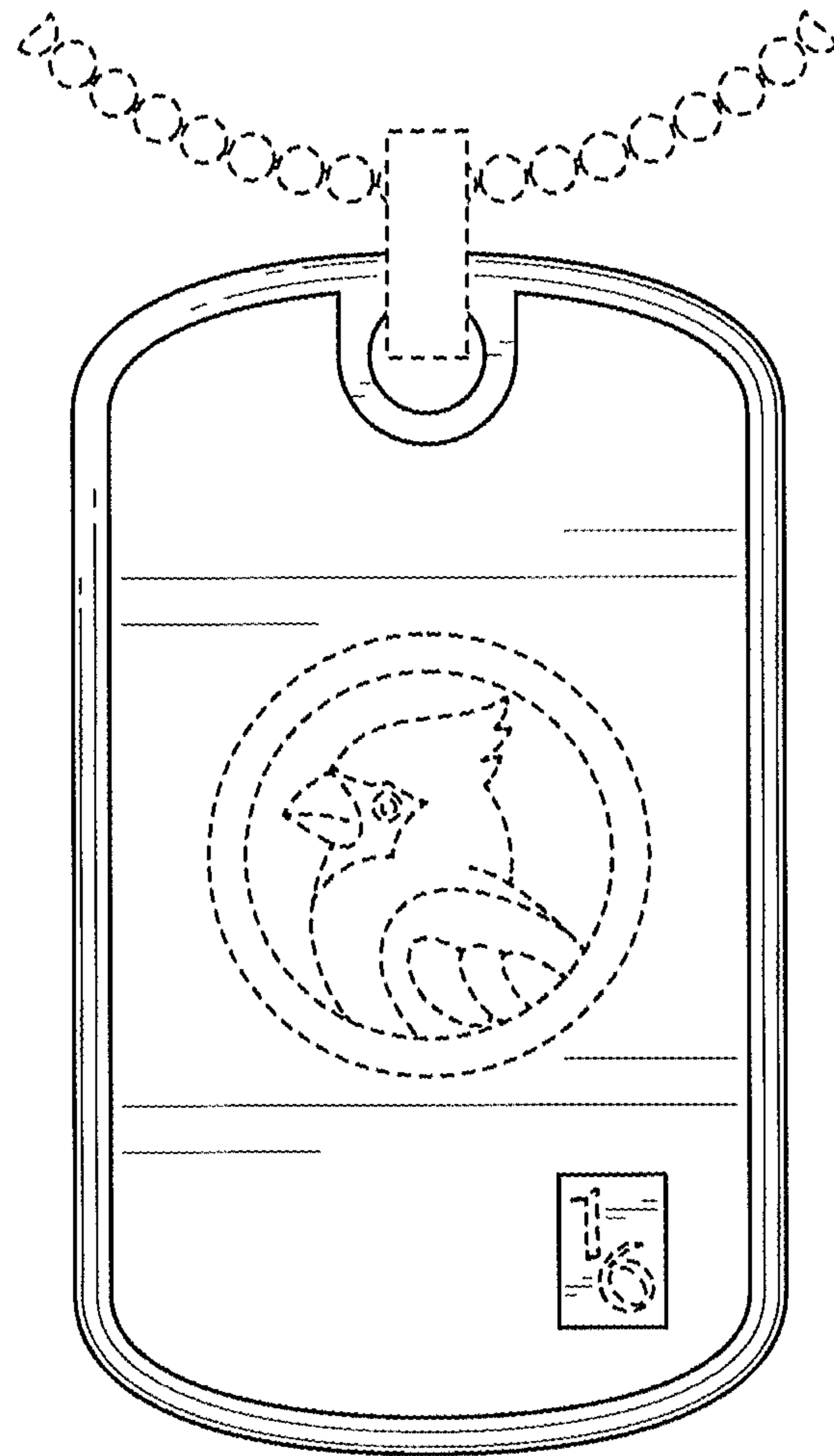

FIG. 30



FIG. 31

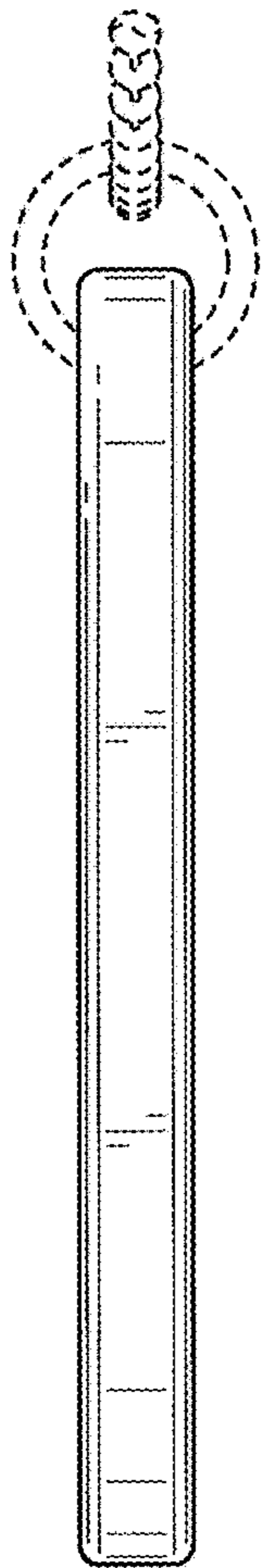

FIG. 32

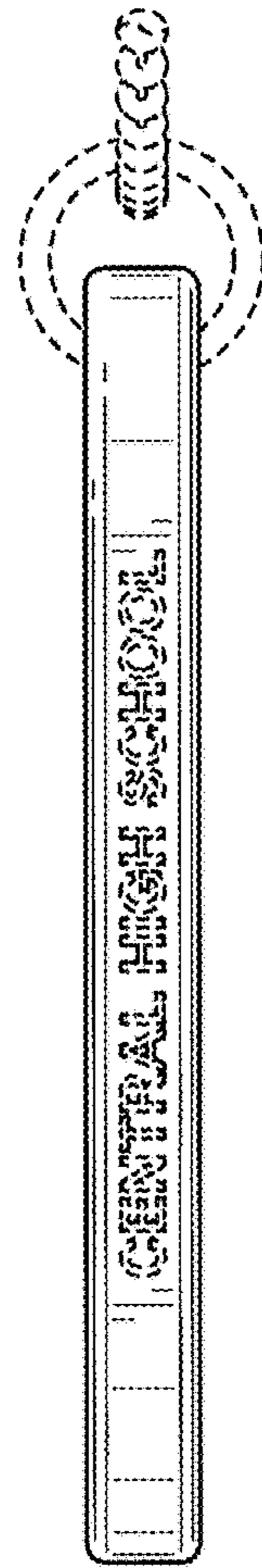

FIG. 33

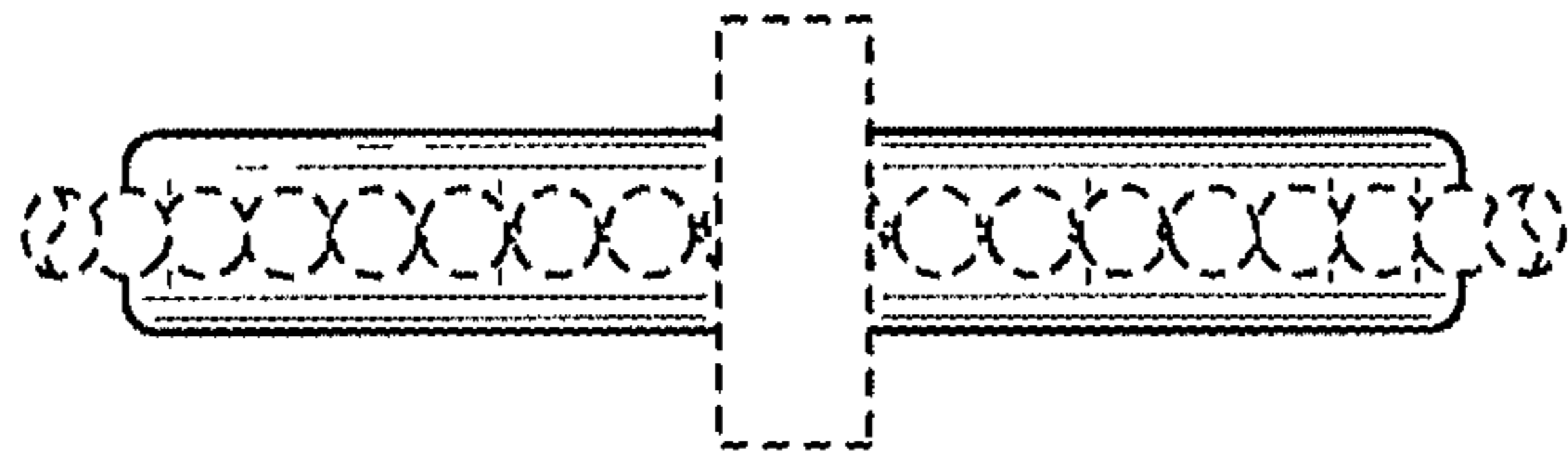

FIG. 34

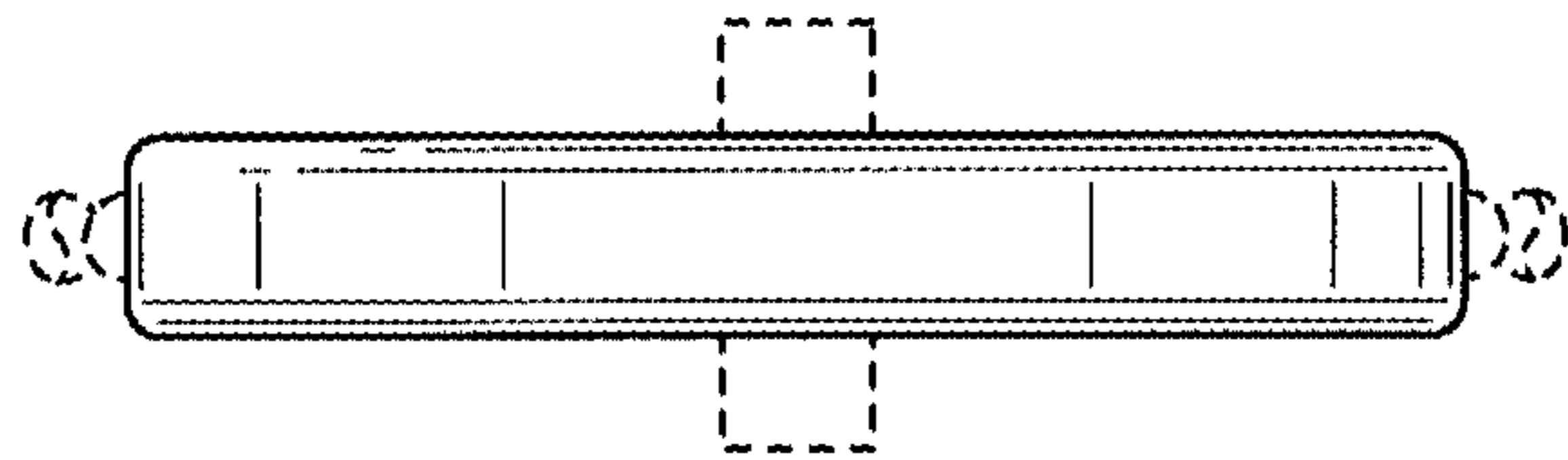

FIG. 35