



US00D779943S

(12) **United States Design Patent** (10) **Patent No.:** **US D779,943 S**
Tulencik et al. (45) **Date of Patent:** **** Feb. 28, 2017**

(54) **BOTTLE CARRIER**

(71) Applicant: **Bath & Body Works Brand Management, Inc.**, Reynoldsburg, OH (US)

(72) Inventors: **Jennifer Tulencik**, Columbus, OH (US); **Heidi Valentino**, New York, NY (US); **Lyndsi Martin**, Newark, OH (US)

(73) Assignee: **Bath & Body Works Brand Management, Inc.**, Reynoldsburg, OH (US)

(**) Term: **14 Years**

(21) Appl. No.: **29/524,814**

(22) Filed: **Apr. 23, 2015**

(30) **Foreign Application Priority Data**

Dec. 19, 2014 (CN) 2014 3 0539511

(51) **LOC (10) Cl.** **09-07**

(52) **U.S. Cl.**

USPC **D9/455; D3/318**

(58) **Field of Classification Search**

USPC D3/202, 215, 318; D6/513; D9/434, 444, D9/445, 455, 499; D14/138 R; 215/399

(Continued)

(56) **References Cited**

U.S. PATENT DOCUMENTS

3,366,360 A 1/1968 Burke
D270,966 S 10/1983 Lynn

(Continued)

FOREIGN PATENT DOCUMENTS

CA 144552 9/2012
CA 144553 9/2012
CN 104522990 A 4/2015

OTHER PUBLICATIONS

Alibaba. Bath Body Works Hand Sanitizer Silicone Holders You Choose the Style—Dongguan Shunjin Plastic Products Co., Ltd. Apr. 15, 2015 [earliest online date], [site visited Sep. 14, 2016]. Available from Internet, <URL:https://www.alibaba.com/product-detail/bath-body-works-hand-sanitizer-silicone_60306216495.html>.*

(Continued)

Primary Examiner — Robert M Spear

Assistant Examiner — Darcey E Heflin

(74) *Attorney, Agent, or Firm* — Andrus Intellectual Property Law, LLP

(57) **CLAIM**

The ornamental design for a bottle carrier, as shown and described.

DESCRIPTION

FIG. 1 is a rear perspective view of a bottle carrier according to our new and ornamental design, with a strap of the bottle carrier shown in a first position;

FIG. 2 is a rear perspective view of the bottle carrier of FIG. 1, with the strap of the bottle carrier shown in a second, alternative position;

FIG. 3 is a rear perspective view of the bottle carrier of FIGS. 1 and 2, with the strap of the bottle carrier shown in a third, alternative position;

FIG. 4 is a front view of the bottle carrier of FIGS. 1-3, with the strap shown in a fourth, alternative position similar to the first position of FIG. 1;

FIG. 5 is a rear view thereof;

FIG. 6 is a left side view thereof;

FIG. 7 is a right side view thereof;

FIG. 8 is a top view thereof;

FIG. 9 is a bottom view thereof;

FIG. 10 is a rear perspective view of an alternative embodiment of a bottle carrier according to our new and ornamental design, with a strap of the bottle carrier shown in the first position of FIG. 1; and,

FIG. 11 is a bottom view of the alternative embodiment of the bottle carrier of FIG. 10, with the strap shown in the

(Continued)

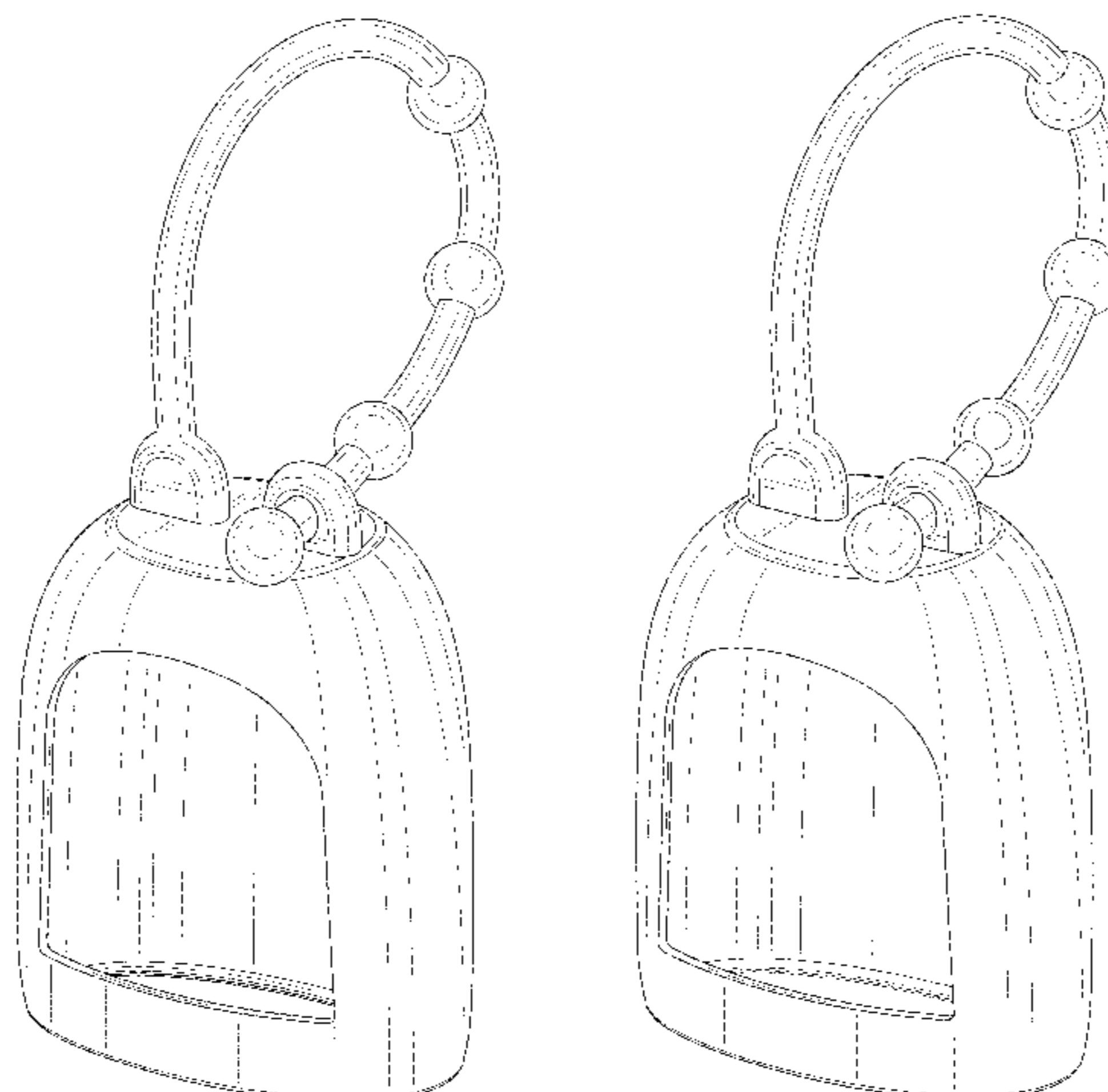

fourth position of FIGS. 4-9, and wherein the front, rear, left side, right side, and top views of the alternative embodiment of the bottle carrier are identical to those shown in FIGS. 4-8, respectively.

In FIGS. 10 and 11, the broken lines represent environmental structure of a lip that may be provided on the bottle carrier; as such, the interior surfaces of the bottle carrier are intended to be part of the claimed design, while the broken lines themselves form no part of the claimed design. The unshaded surfaces form no part of the claim.

1 Claim, 11 Drawing Sheets

(58) **Field of Classification Search**

CPC A45F 2005/008; A45F 5/10
See application file for complete search history.

(56) **References Cited**

U.S. PATENT DOCUMENTS

D315,829 S	4/1991	Covington	
D317,869 S	7/1991	Kipperman et al.	
D318,017 S	7/1991	Patterson	
D321,885 S	11/1991	Sheldrake	
D324,176 S	2/1992	Patterson	
D327,431 S	6/1992	Farricielli	
5,135,125 A *	8/1992	Andel	A61M 5/1417 215/12.1
D333,784 S	3/1993	Goodman	
D336,778 S	6/1993	Miller	
D367,999 S	3/1996	McCallum	
D407,210 S	3/1999	Lauth, III	
D414,110 S	9/1999	Gueret	
D419,072 S	1/2000	Khaled	
D444,066 S	6/2001	Fenton et al.	
D446,007 S	8/2001	Gillilan	

D448,298 S	9/2001	Simkins	
D455,258 S	4/2002	Goserud	
6,481,590 B1 *	11/2002	Simkins	A45F 5/00 215/12.1
D478,721 S	8/2003	Anderton	
D487,660 S *	3/2004	Sayers	D6/513
6,758,453 B1	7/2004	Ralko	
D507,870 S	8/2005	Anderton	
D510,479 S *	10/2005	Ellis	D3/215
D512,910 S *	12/2005	Haslam	D9/434
D523,302 S	6/2006	Mandell et al.	
D534,889 S	1/2007	Cheng	
D549,099 S	8/2007	Edwards	
D581,010 S	11/2008	Sparks et al.	
D583,903 S	12/2008	Sparks et al.	
D584,146 S	1/2009	Lown et al.	
D585,224 S	1/2009	Hwang	
D594,745 S *	6/2009	Hecht	D9/434
D626,409 S *	11/2010	Hooley	D7/622
D644,427 S	9/2011	Cunningham et al.	
D648,522 S *	11/2011	Gorman	D3/215
D675,446 S	2/2013	Cohee et al.	
D696,006 S	12/2013	Lee et al.	
D703,040 S *	4/2014	White	D9/434
D707,041 S	6/2014	Park et al.	
D712,135 S	9/2014	Huang et al.	
D738,726 S *	9/2015	Peluso	D3/318
D753,909 S *	4/2016	Tulencik	D3/202
D764,787 S *	8/2016	Montminy	D3/202

OTHER PUBLICATIONS

Notice of Grant of Patent Right for Design issued in corresponding Chinese Design Appln. No. 201430539511.1, dated May 11, 2015.
Notice of Grant of Patent Right for Design issued in Chinese Design Appln. No. 201430539108.9, dated May 11, 2015.
Notice of Grant of Patent Right for Design issued in Chinese Design Appln. No. 201430538952.X, dated May 11, 2015.

* cited by examiner

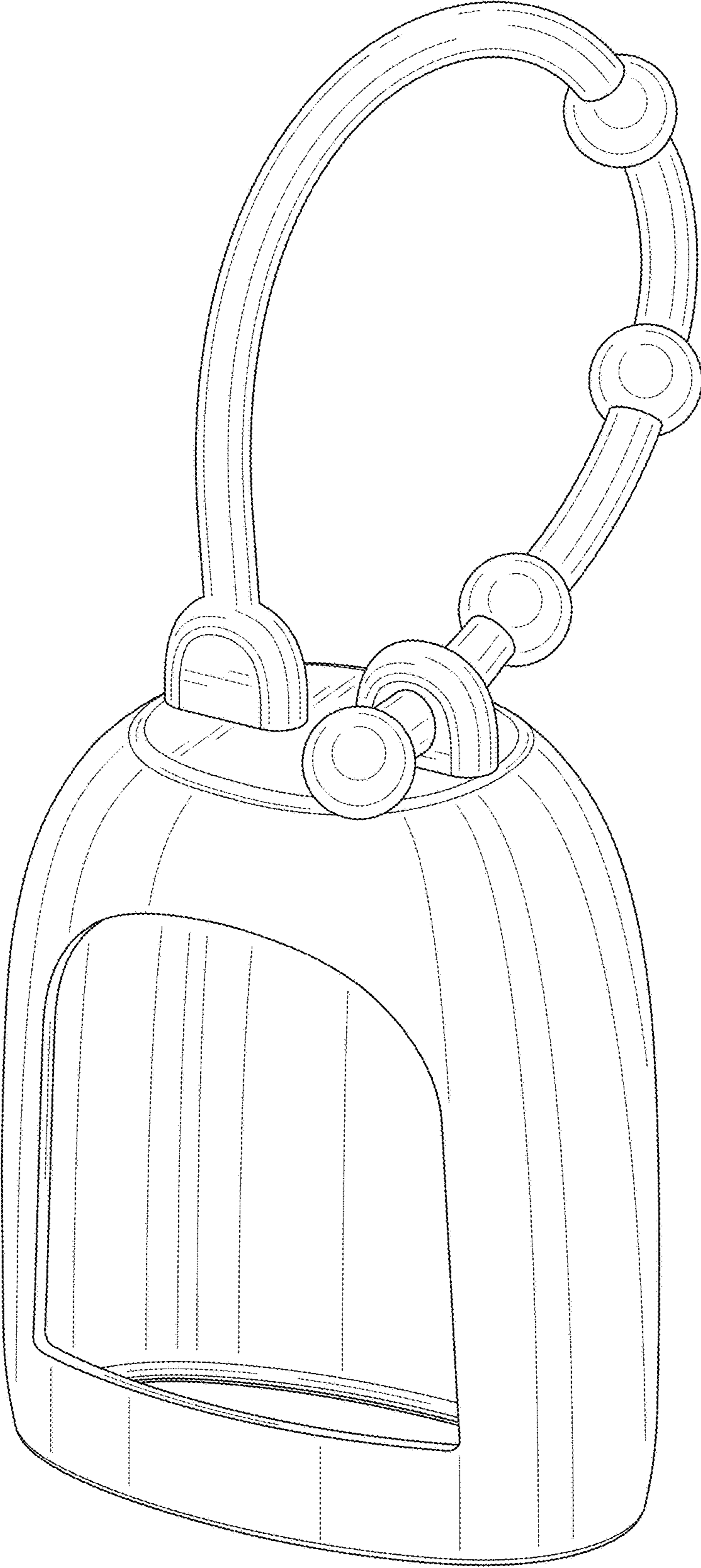

FIG. 1



FIG. 2

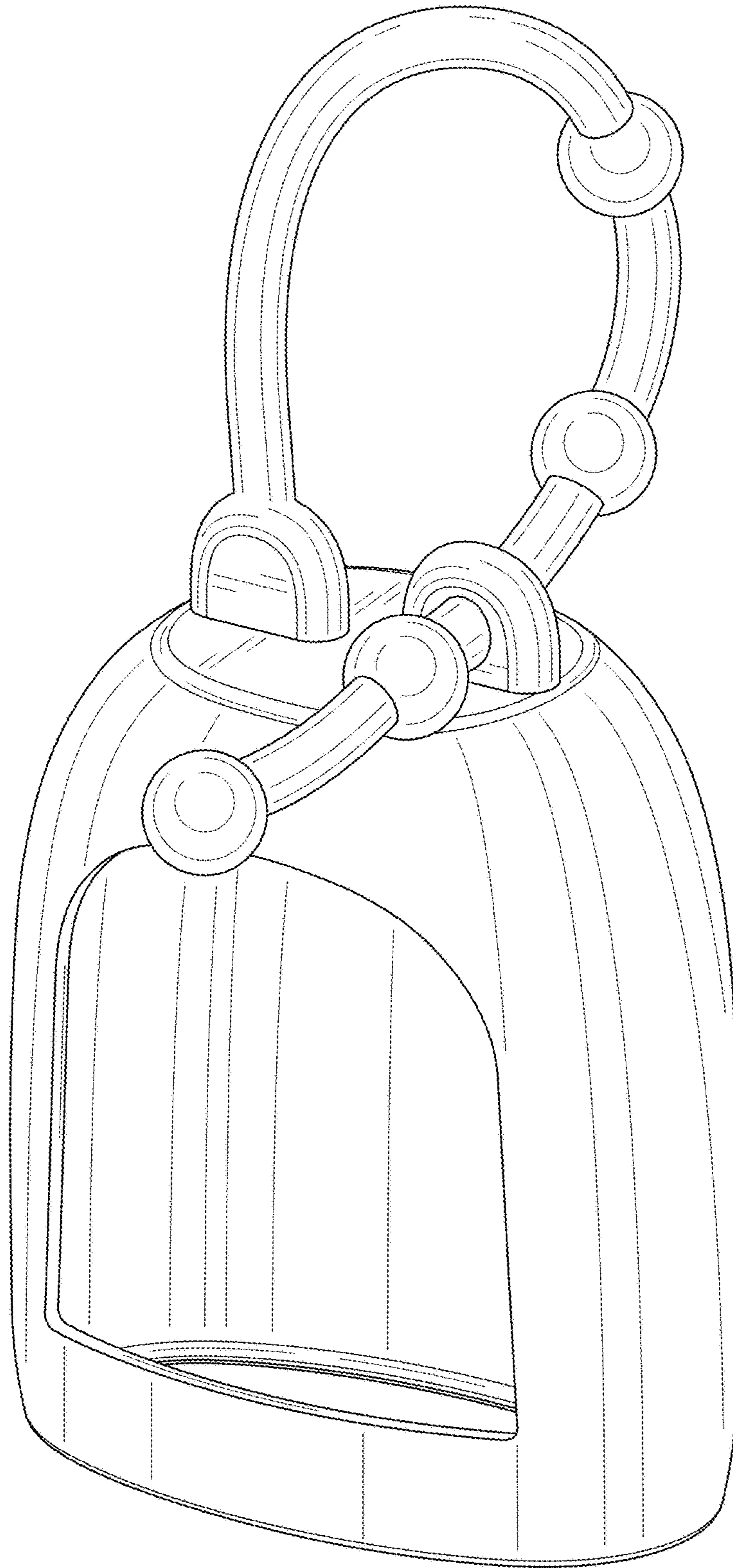

FIG. 3

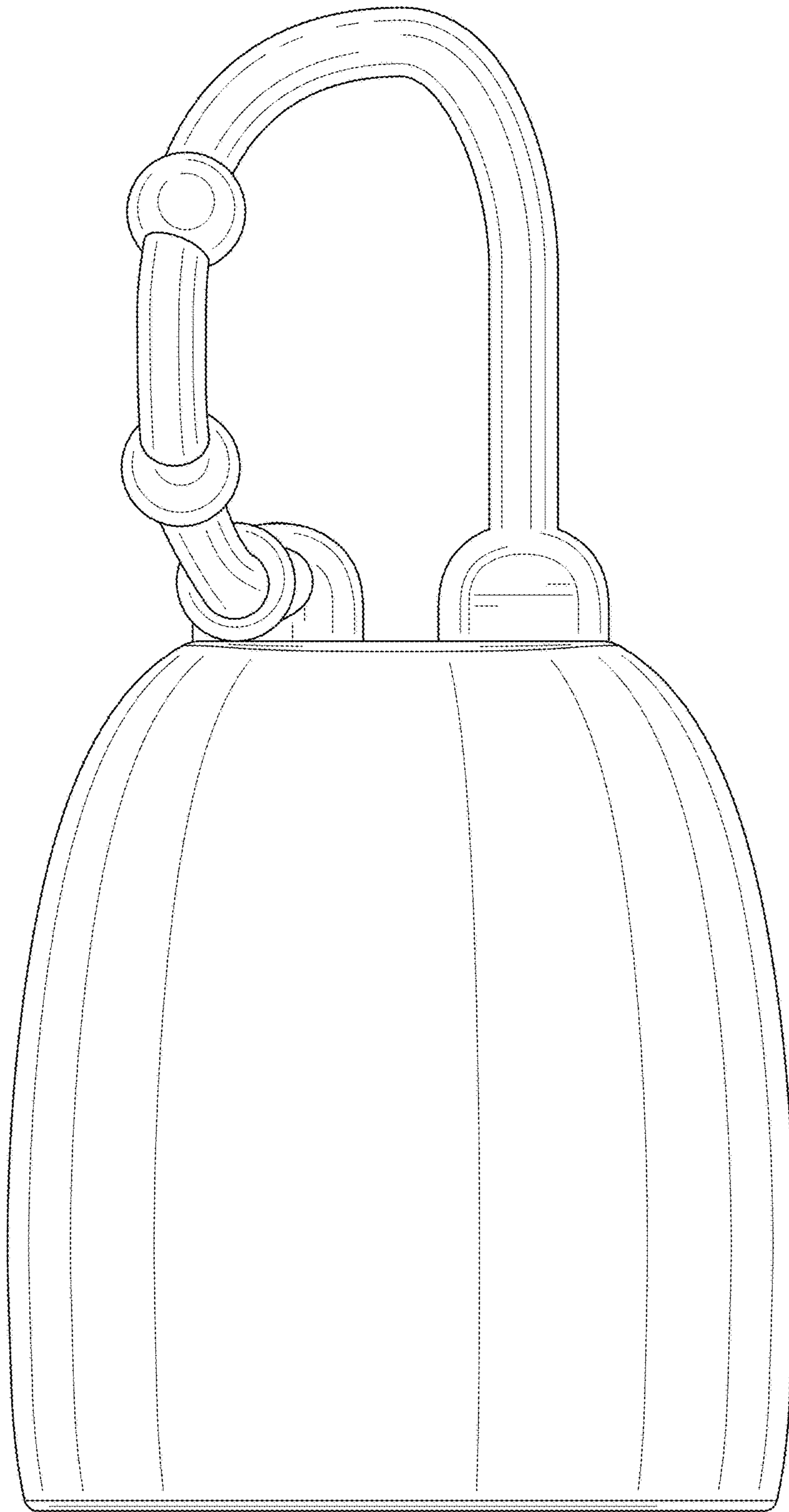

FIG. 4

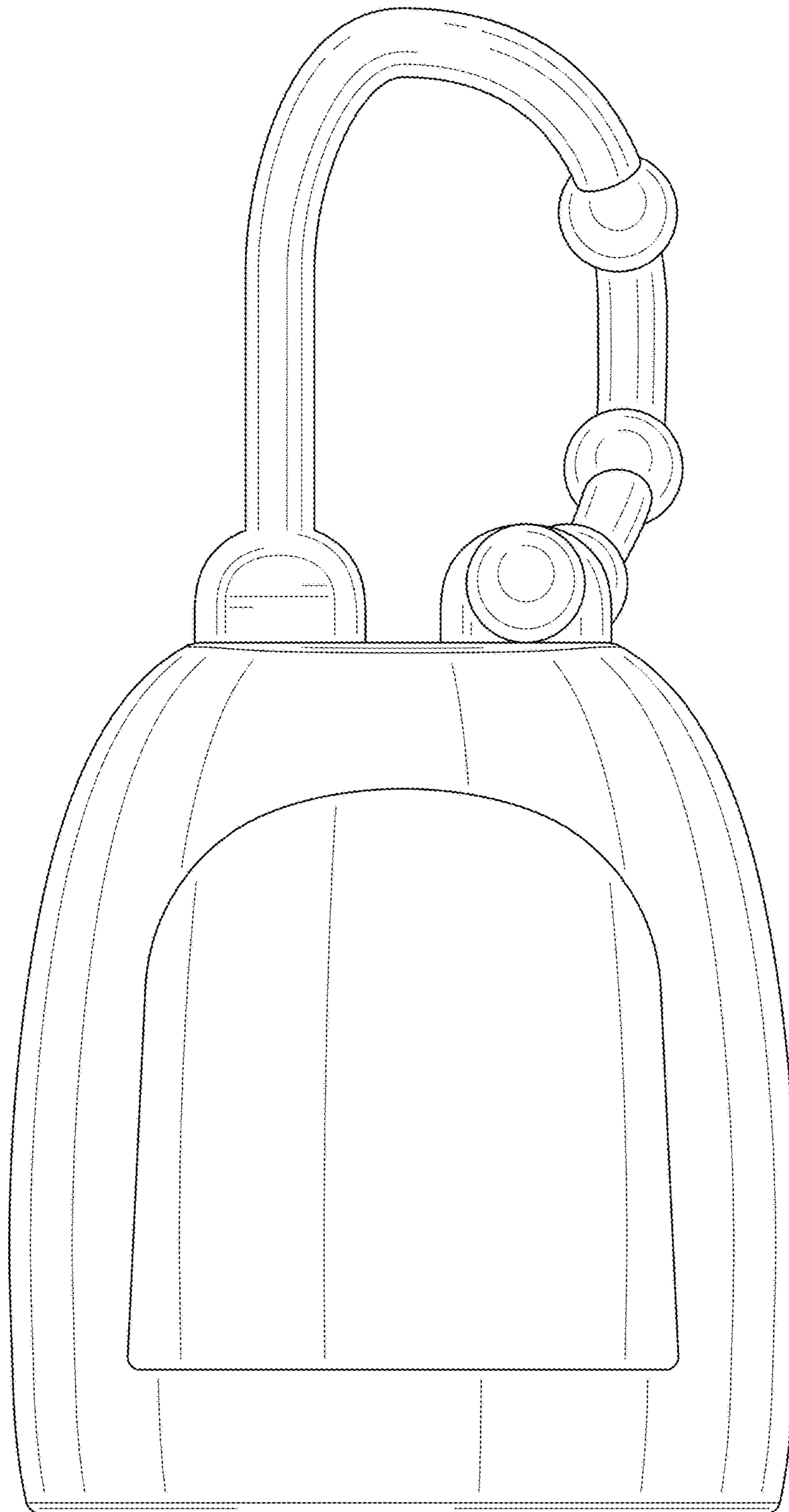

FIG. 5

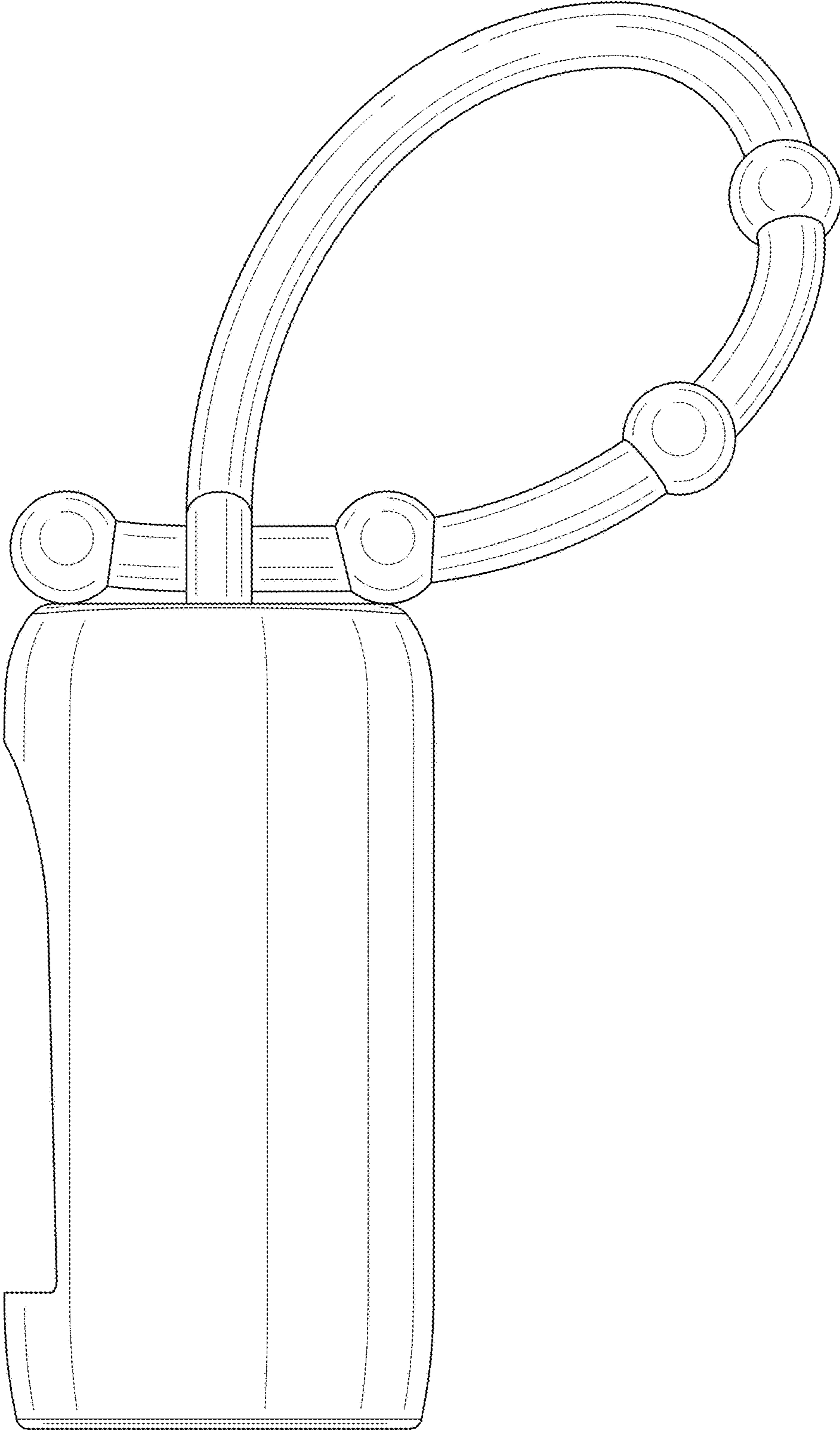

FIG. 6

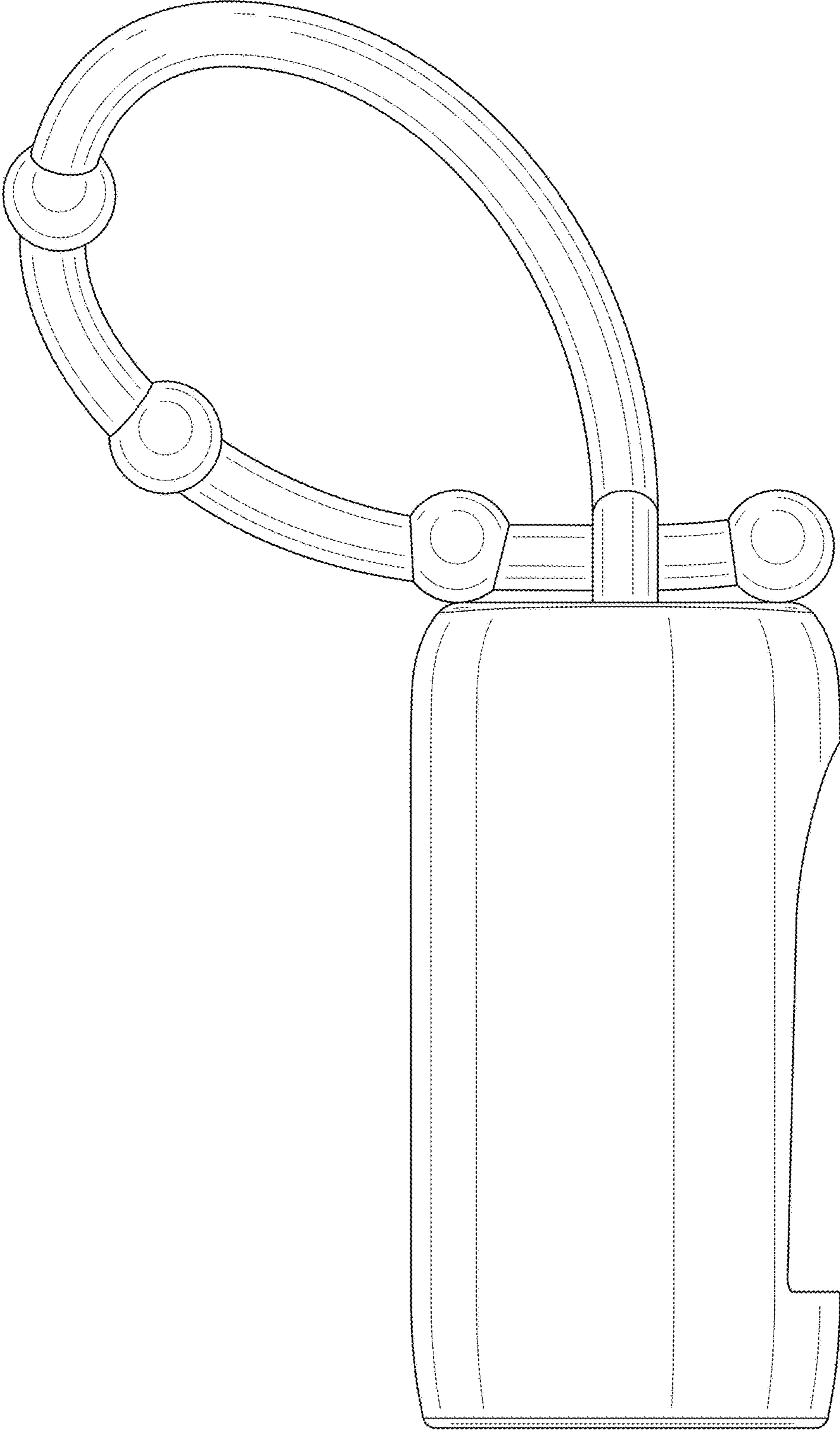

FIG. 7

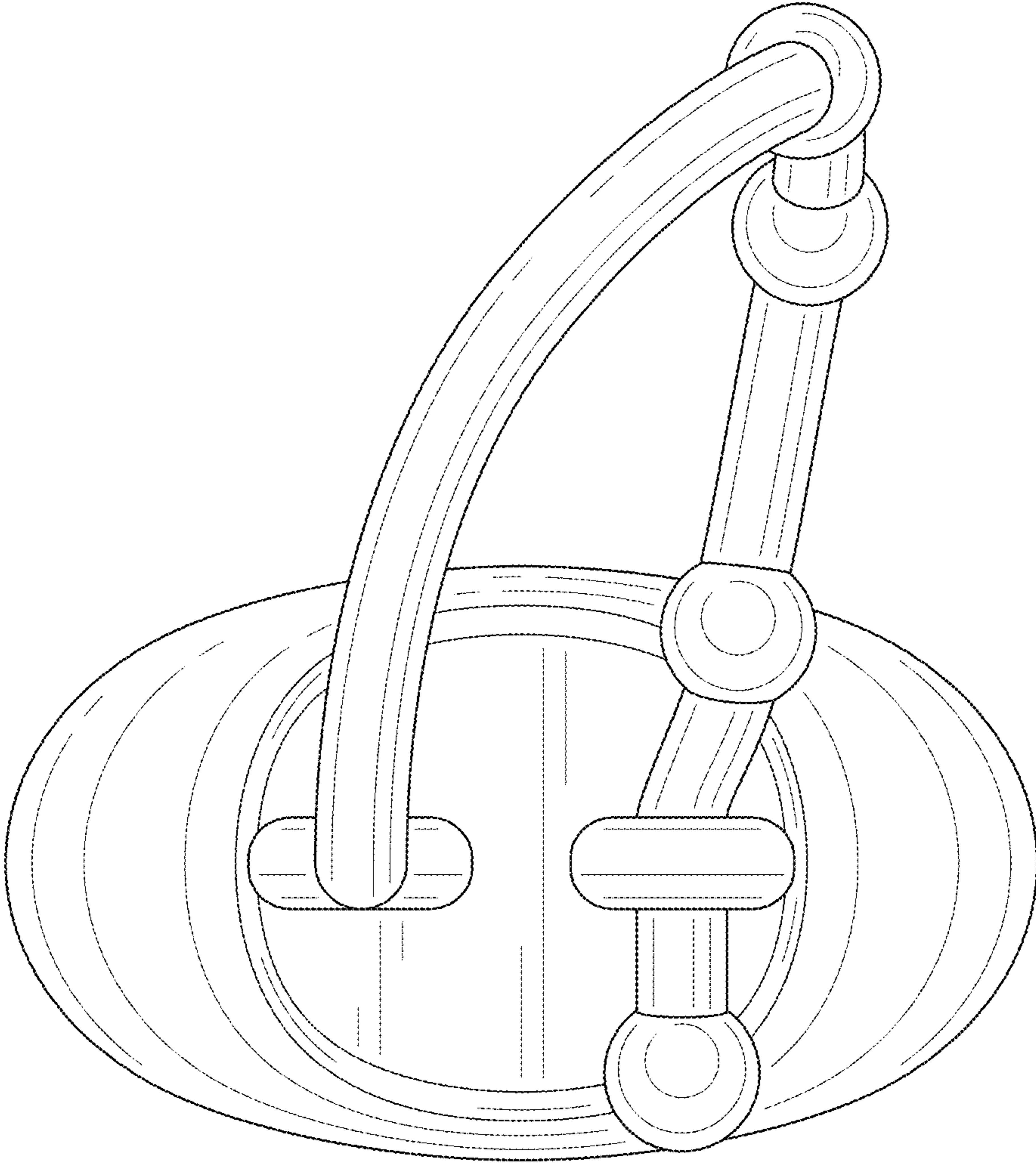

FIG. 8

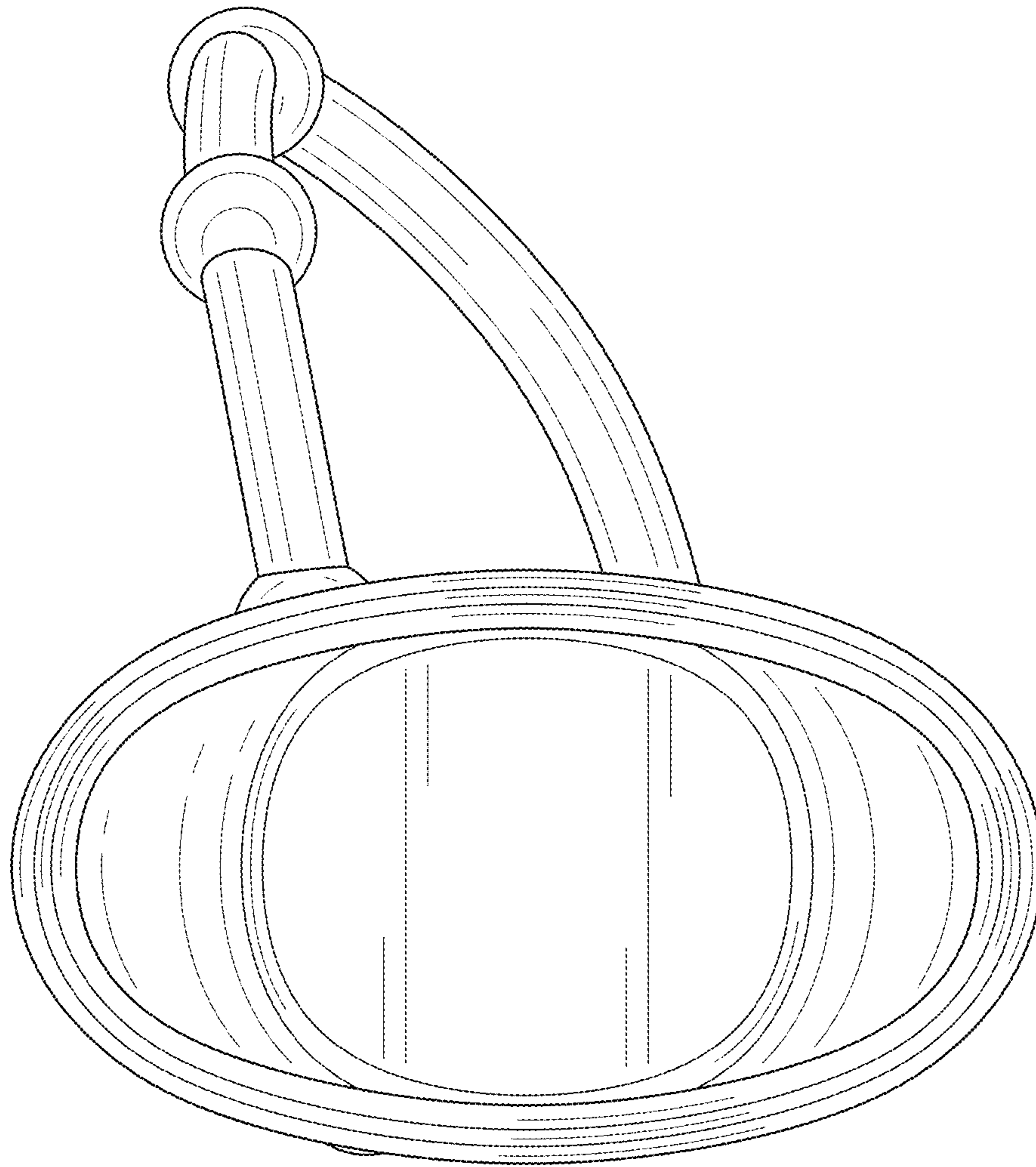

FIG. 9

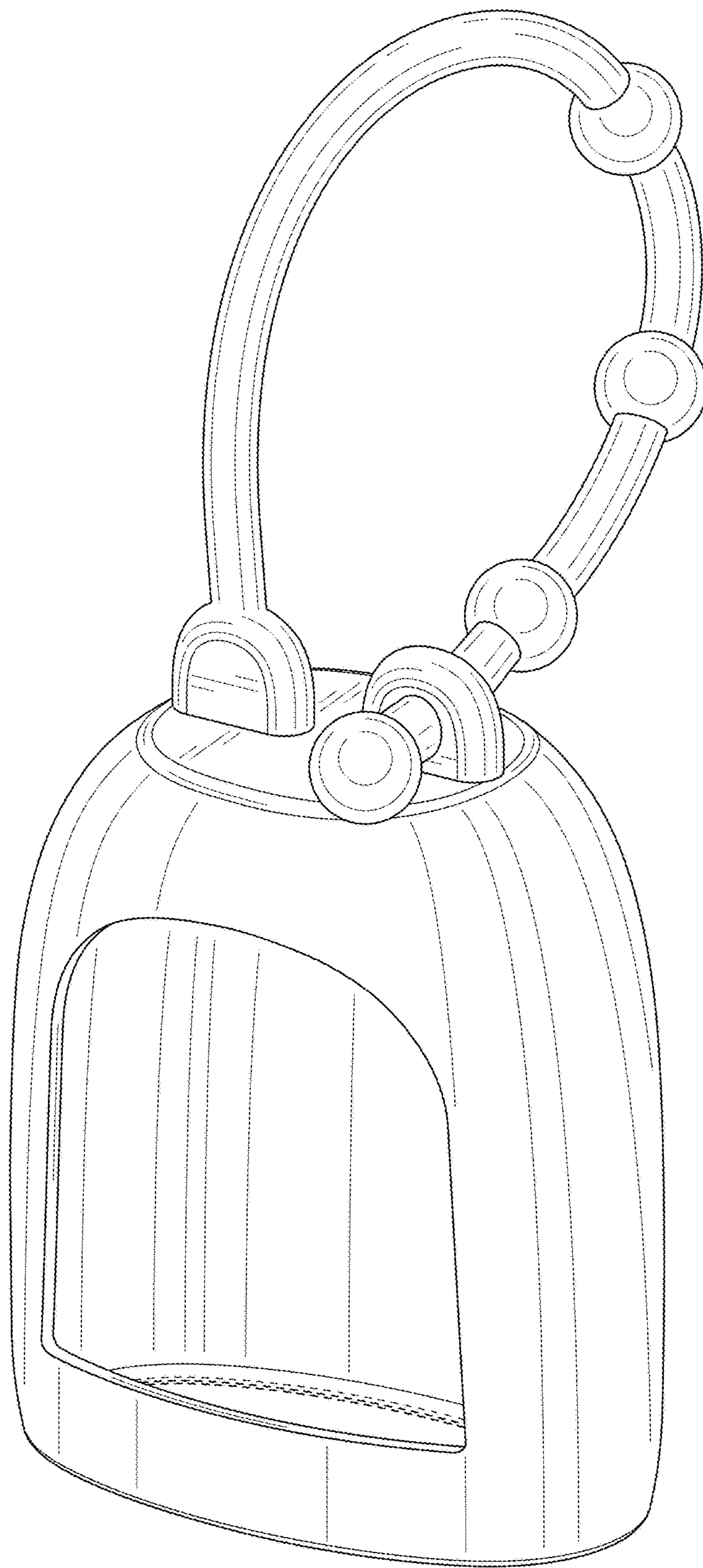

FIG. 10

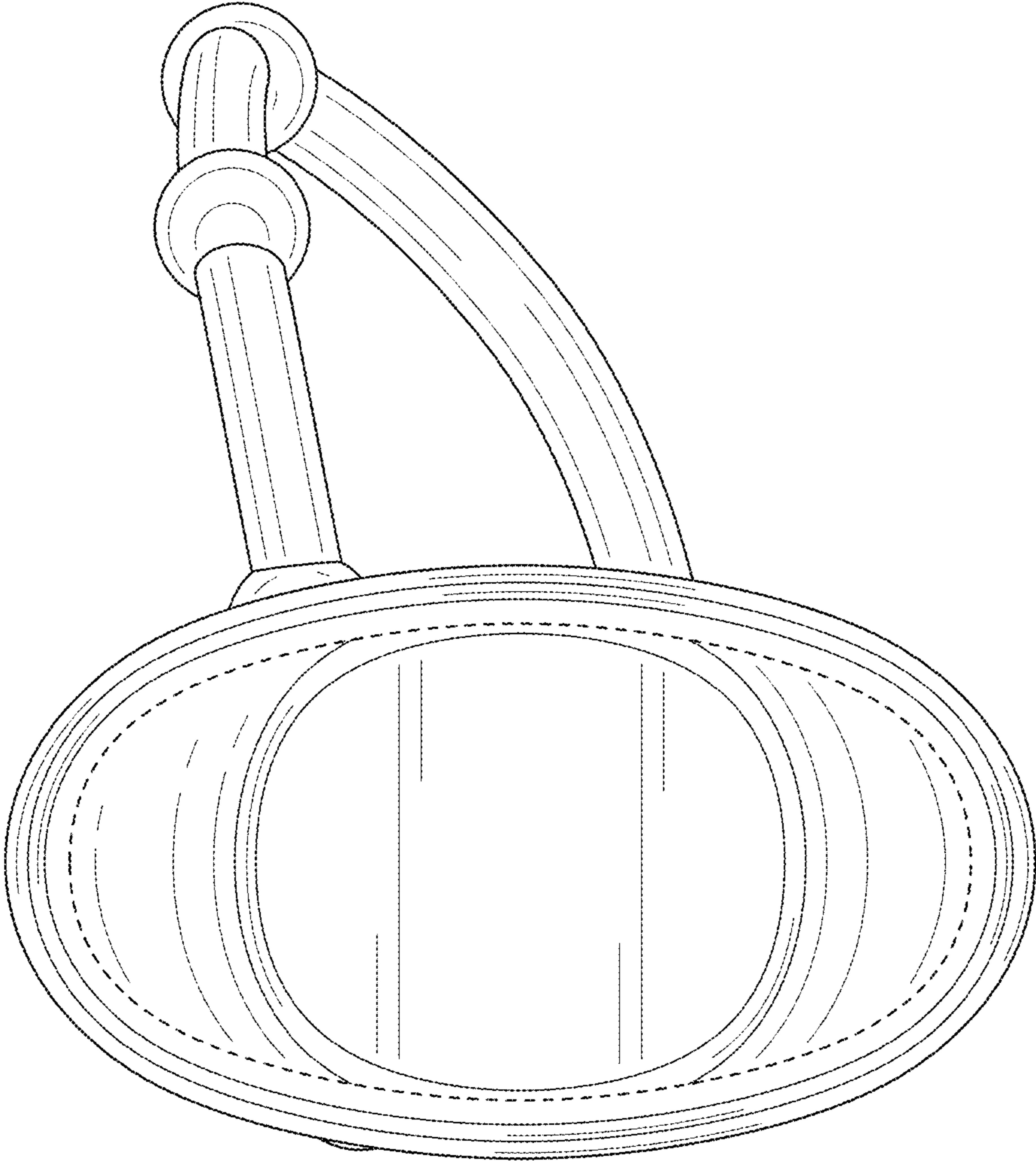

FIG. 11