



US00D779853S

(12) **United States Design Patent** (10) **Patent No.:** **US D779,853 S**
Taylor (45) **Date of Patent:** **** Feb. 28, 2017**

(54) **CLOTHING HANGER**

D509,391 S * 9/2005 Hamori D6/553
D572,128 S * 7/2008 Poulsen D8/395
8,151,808 B2 * 4/2012 Tu A45D 8/14
132/276

(71) Applicant: **The Janger Limited**, London (GB)

(72) Inventor: **Guy Taylor**, London (GB)

* cited by examiner

(73) Assignee: **The Janger Limited**, London (GB)

Primary Examiner — Wan Laymon

Assistant Examiner — Mark Booker

(**) Term: **14 Years**

(74) *Attorney, Agent, or Firm* — Renner, Otto, Boisselle & Sklar, LLP

(21) Appl. No.: **29/502,034**

(22) Filed: **Sep. 11, 2014**

(57) **CLAIM**

(51) **LOC (10) Cl.** **06-08**

The ornamental design for a clothing hanger, as shown and described.

(52) **U.S. Cl.**

USPC **D6/553**

(58) **Field of Classification Search**

DESCRIPTION

USPC D6/553, 315, 323, 326, 328; D8/394,
D8/395; 24/455, 545, 546, 547, 555, 556,
24/562; 211/13.1, 85.3; 223/85, 88, 90,
223/91, 93, 96, DIG. 2

CPC A47G 25/441; A47G 25/44; A47G 25/442;
A47G 25/485

See application file for complete search history.

FIG. 1 is a front view of a clothing hanger showing my design.

FIG. 2 is a right side view thereof.

FIG. 3 is a rear view thereof.

FIG. 4 is a left side view thereof.

FIG. 5 is a bottom view thereof.

FIG. 6 is a top view thereof; and,

FIG. 7 is a reduced size perspective view thereof.

The portions of the clothing hanger shown in broken lines form no part of the claimed design.

(56) **References Cited**

U.S. PATENT DOCUMENTS

5,113,554 A * 5/1992 Gallo A47G 25/485
223/88

1 Claim, 3 Drawing Sheets

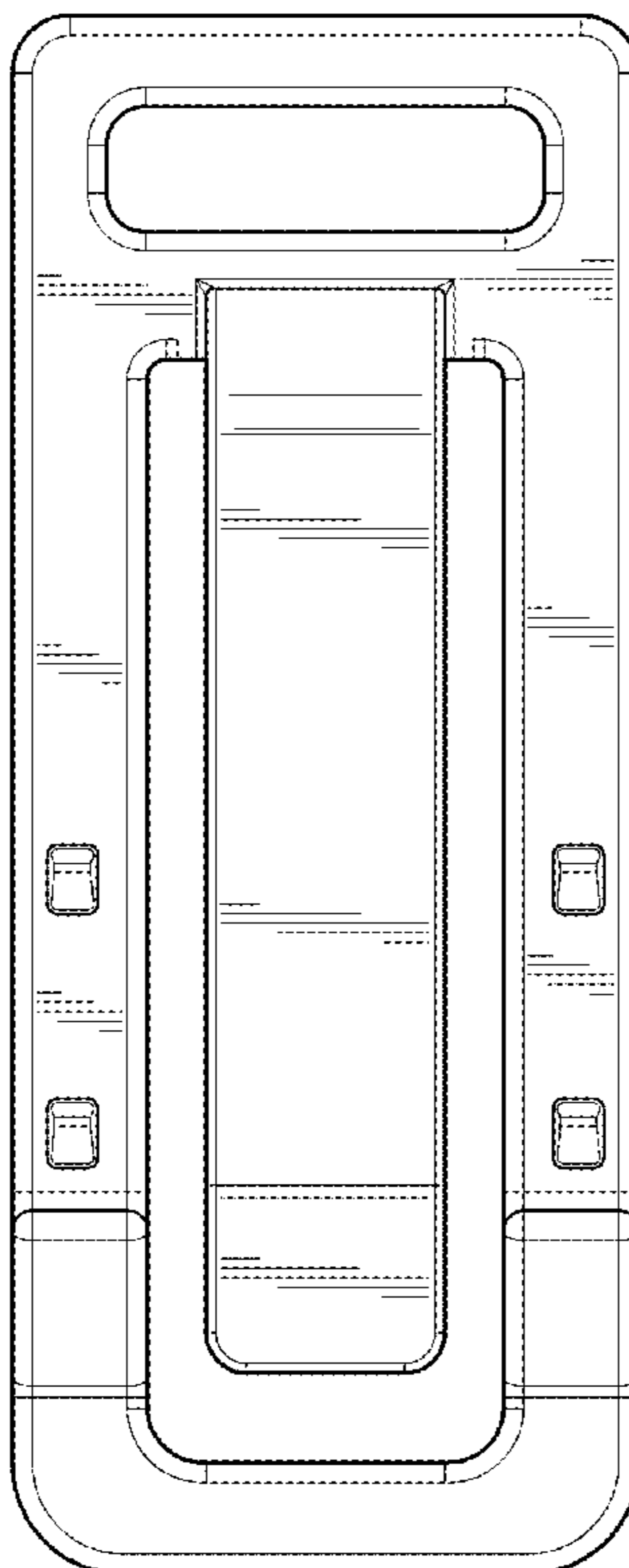

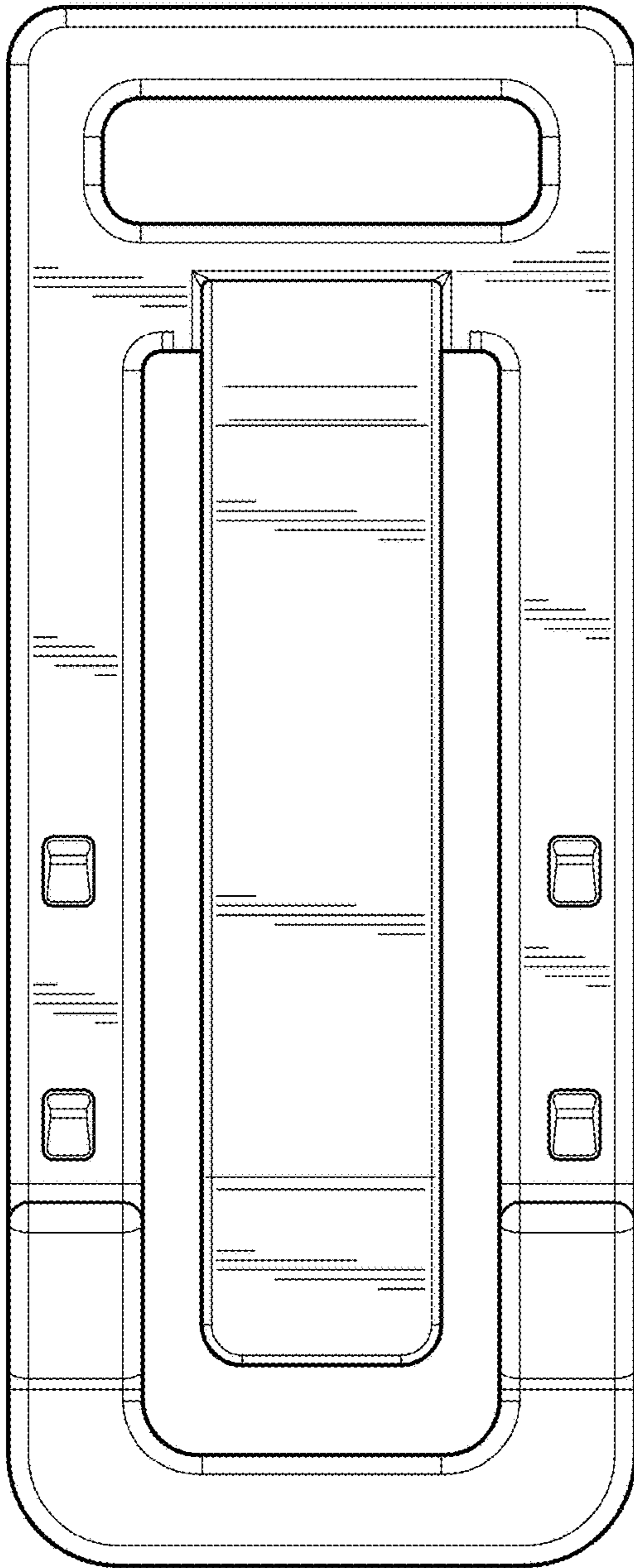

FIG. 1

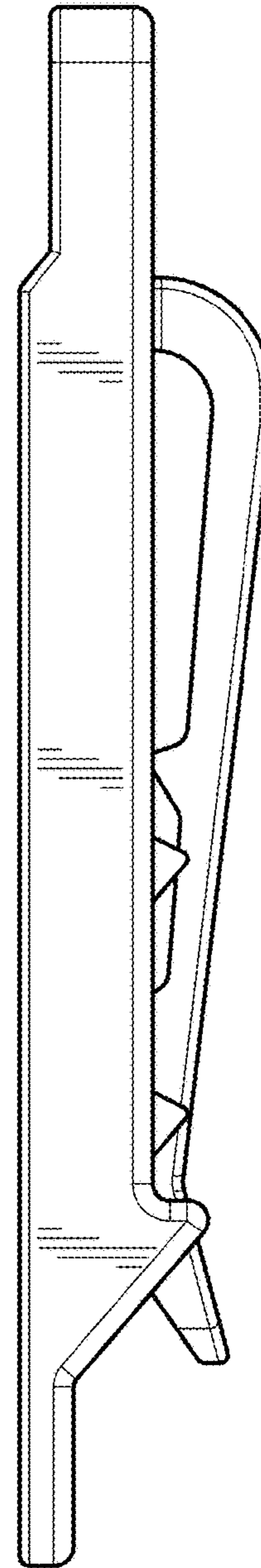

FIG. 2

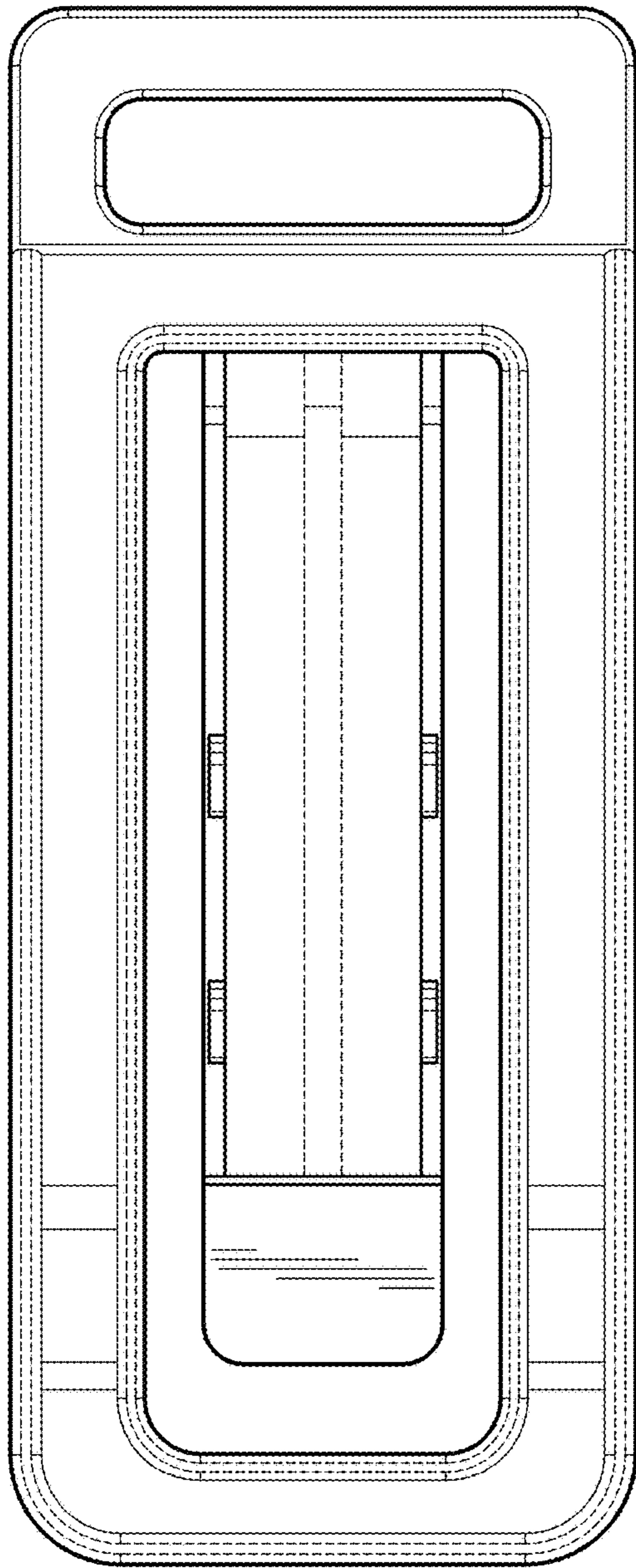

FIG. 3

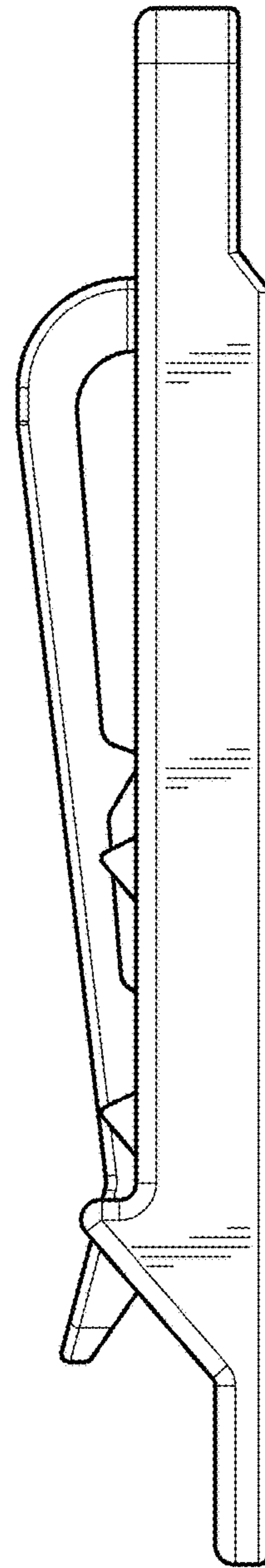

FIG. 4

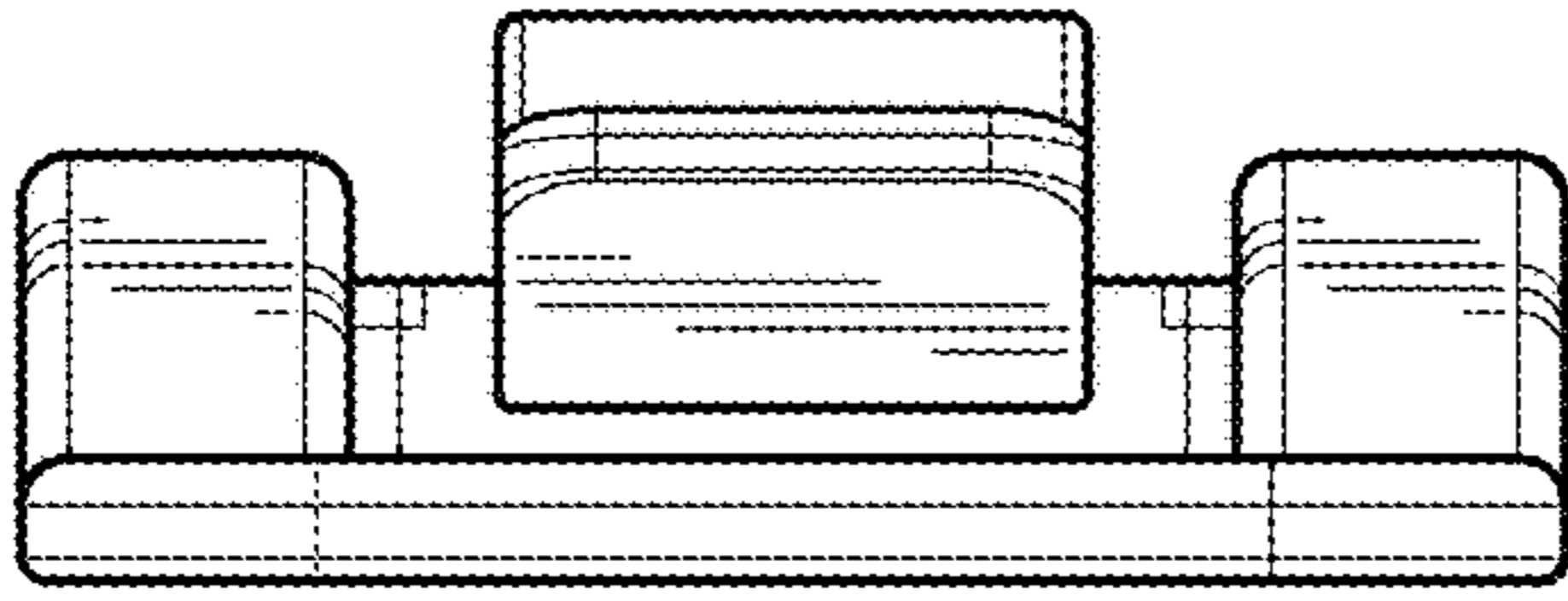

FIG. 5

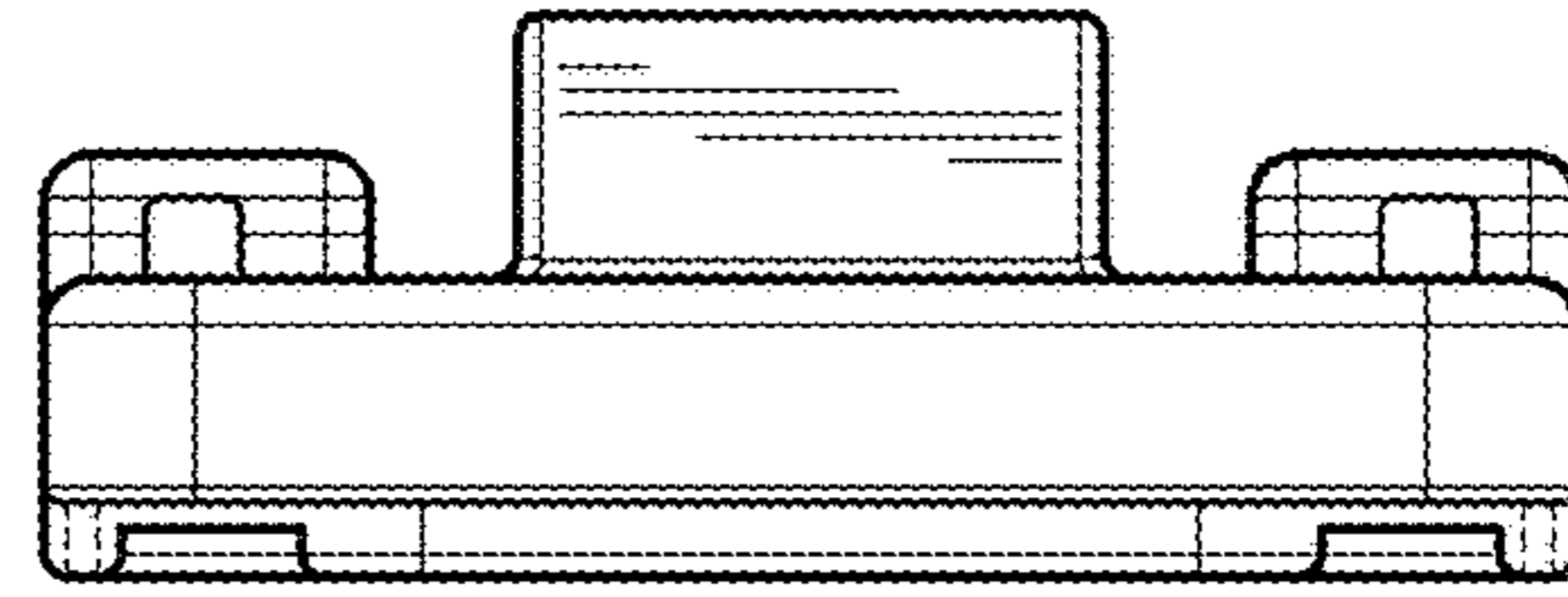

FIG. 6

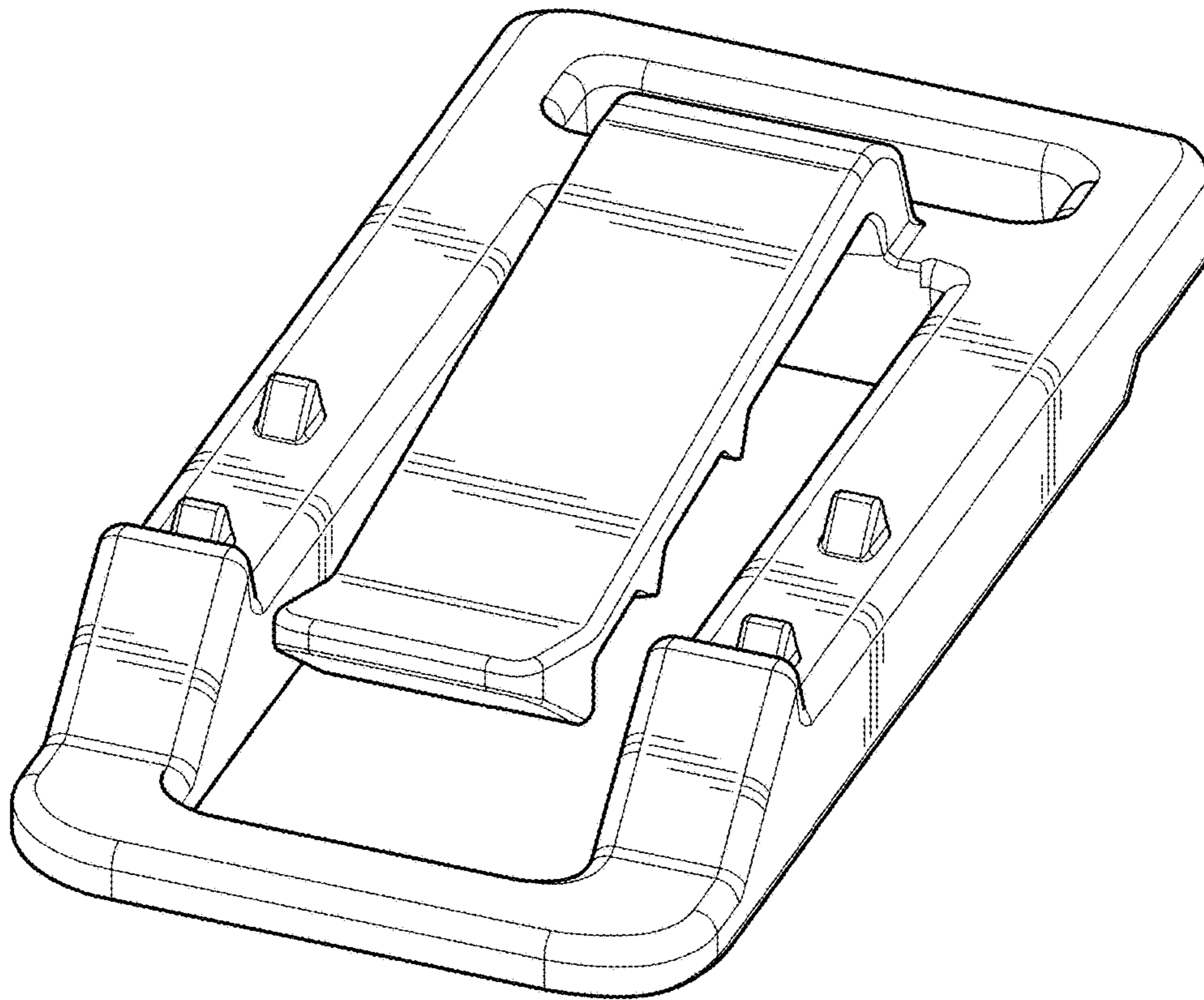

FIG. 7