



US00D779852S

(12) **United States Design Patent** (10) **Patent No.:** **US D779,852 S**  
**Covert et al.** (45) **Date of Patent:** **\*\* Feb. 28, 2017**

(54) **STAINLESS STEEL SAUCE AND SOUFFLE CUP HOLDER**

D307,086 S \* 4/1990 Van Marcke ..... 30/128  
D310,760 S \* 9/1990 Murphy ..... D6/515  
D311,260 S \* 10/1990 Hasert ..... D28/85

(71) Applicant: **COMPETITIVE EDGE SERVICES, INC.**, Coral Springs, FL (US)

(Continued)

(72) Inventors: **Earl H. Covert**, Coral Springs, FL (US); **Misael Bonifaz**, Coral Springs, FL (US)

*Primary Examiner* — David Muller

*Assistant Examiner* — Nathan Johnston

(73) Assignee: **Competitive Edge Services, Inc.**, Coral Springs, FL (US)

(74) *Attorney, Agent, or Firm* — Laurence A. Greenberg; Werner H. Stemer; Ralph E. Locher

(\*\*) Term: **15 Years**

(57) **CLAIM**

The ornamental design for a stainless steel sauce and soufflé cup holder, as shown and described.

(21) Appl. No.: **29/549,707**

**DESCRIPTION**

(22) Filed: **Dec. 28, 2015**

(51) **LOC (10) Cl.** ..... **20-02**

(52) **U.S. Cl.**  
USPC ..... **D6/516**

(58) **Field of Classification Search**  
USPC ..... D6/515–516; 211/13.1, 49.1, 74;  
206/217, 427; 221/45, 282–285;  
222/173, 180, 181.1, 181.2  
CPC ..... A47F 1/085; G07F 13/10; G07F 13/065  
See application file for complete search history.

FIG. 1 is a front elevation view of a first embodiment of the stainless steel sauce and soufflé cup holder showing my new invention;

FIG. 2 is a rear elevation view thereof;

FIG. 3 is a side elevation view thereof;

FIG. 4 is a top plan view thereof;

FIG. 5 is a bottom plan view thereof;

FIG. 6 is a perspective view thereof;

FIG. 7 is a partial front elevation view with unclaimed environmental elements in the form of a cup;

FIG. 8 is a front elevation view of a second embodiment of the stainless steel sauce and soufflé cup holder showing my new invention;

FIG. 9 is a rear elevation view thereof;

FIG. 10 is a side elevation view thereof;

FIG. 11 is a top plan view thereof;

FIG. 12 is a bottom plan view thereof; and,

FIG. 13 is a perspective view thereof.

The broken line showing of parts of the drawings is included for the purpose of illustrating use and environment and forms no part of the claimed design.

(56) **References Cited**

U.S. PATENT DOCUMENTS

D248,128 S \* 6/1978 Mineo ..... D6/514  
D249,764 S \* 10/1978 Burklacich ..... D6/517  
D258,777 S \* 4/1981 Kailey ..... D3/24  
4,314,679 A \* 2/1982 Paul ..... A47K 10/3827  
242/560.3  
D291,392 S \* 8/1987 Worthen ..... D34/7  
D302,504 S \* 8/1989 Levy ..... D6/520  
D306,104 S \* 2/1990 Merdic ..... D6/523  
D306,946 S \* 4/1990 Merdic ..... D6/520

**1 Claim, 6 Drawing Sheets**

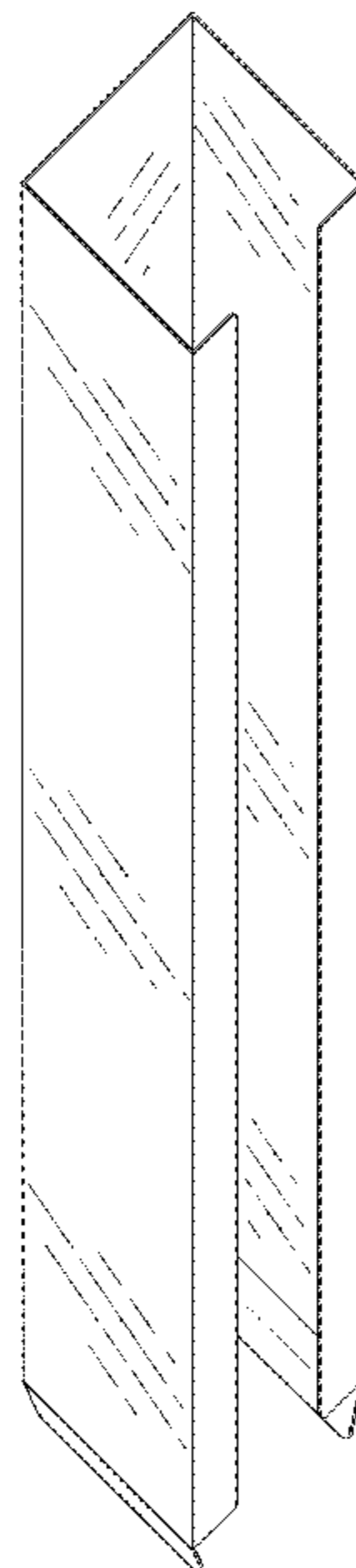

(56)

**References Cited**

## U.S. PATENT DOCUMENTS

D321,647	S	*	11/1991	Oldorf	.....	D6/517
D359,987	S	*	7/1995	Yoshikawa	.....	D19/86
D365,952	S	*	1/1996	Gagnon	.....	D30/124
D366,583	S	*	1/1996	Scaife	.....	D6/515
D378,641	S	*	4/1997	Beckenlehner	.....	D6/520
D381,538	S	*	7/1997	Smith	.....	D6/520
D381,847	S	*	8/1997	Shingles	.....	D6/513
D382,572	S	*	8/1997	Greenway	.....	D15/89
D407,588	S	*	4/1999	Padilla	.....	D6/520
6,302,350	B1	*	10/2001	Burrell	.....	A47K 10/38 242/560
D475,227	S	*	6/2003	Clarke	.....	D6/520
D482,914	S	*	12/2003	Prasad	.....	D6/515
D509,689	S	*	9/2005	Ho	.....	D6/515
D527,936	S	*	9/2006	Sirkis	.....	D6/520
D546,605	S	*	7/2007	Wolfson	.....	D6/520
D551,000	S	*	9/2007	Romano	.....	D6/520
D553,403	S	*	10/2007	Williams	.....	D6/520
D572,955	S	*	7/2008	Barcena Zafra	.....	D6/515
D585,224	S	*	1/2009	Hwang	.....	D6/553
D598,690	S	*	8/2009	Ackland	.....	D6/570
D625,534	S	*	10/2010	Chen	.....	D6/566
D627,181	S	*	11/2010	Lehr	.....	D6/515
D642,837	S	*	8/2011	Gray	.....	D6/513
D665,208	S	*	8/2012	Lombardo	.....	D6/520
D690,129	S	*	9/2013	Clough	.....	D6/542
D690,958	S	*	10/2013	Orton	.....	D6/515
D727,056	S	*	4/2015	Frankel	.....	D6/518
D727,057	S	*	4/2015	Frankel	.....	D6/518

\* cited by examiner

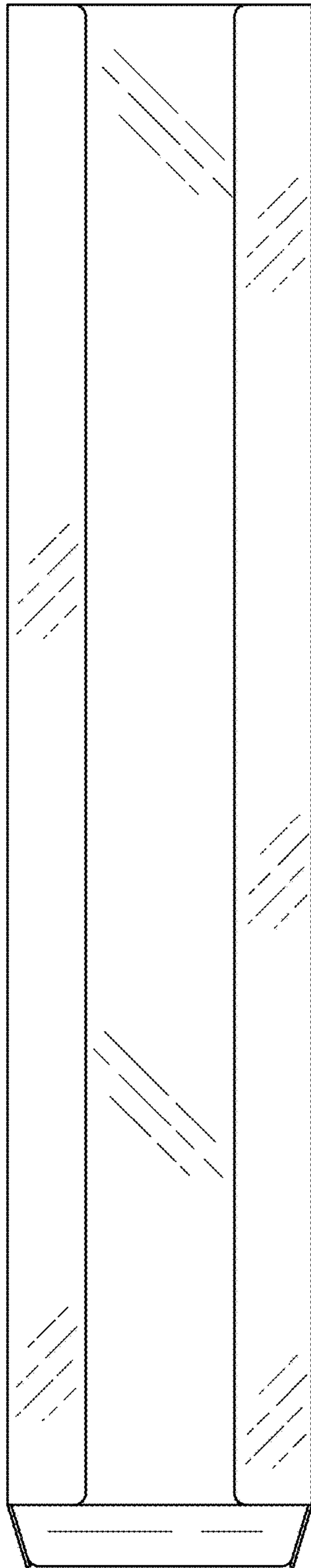

Fig. 1

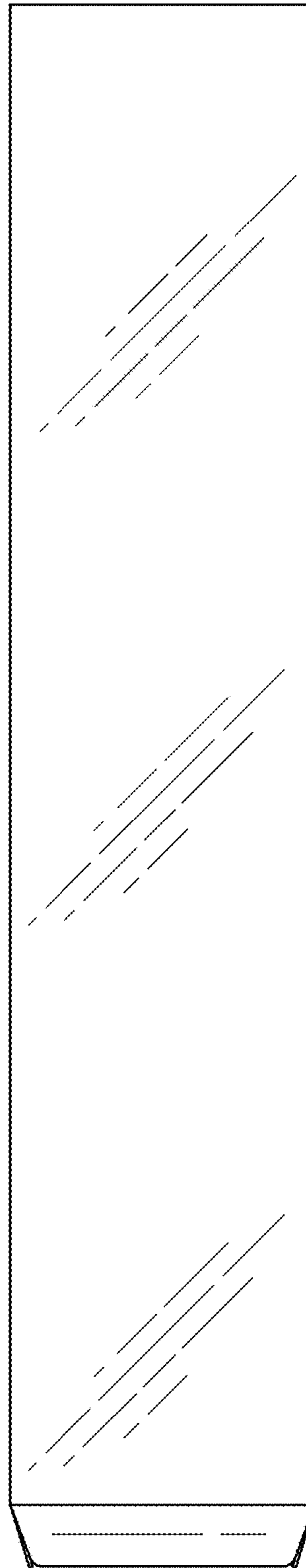

Fig. 2

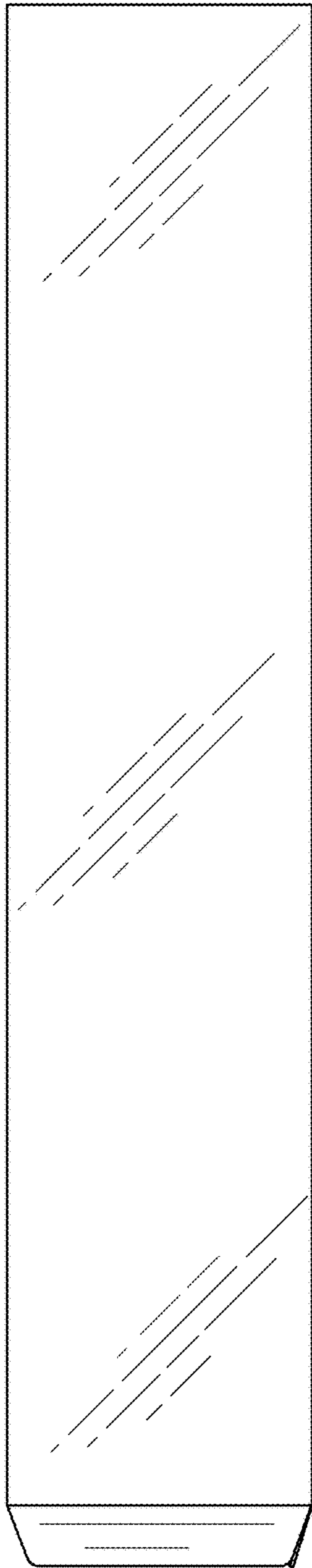

Fig. 3

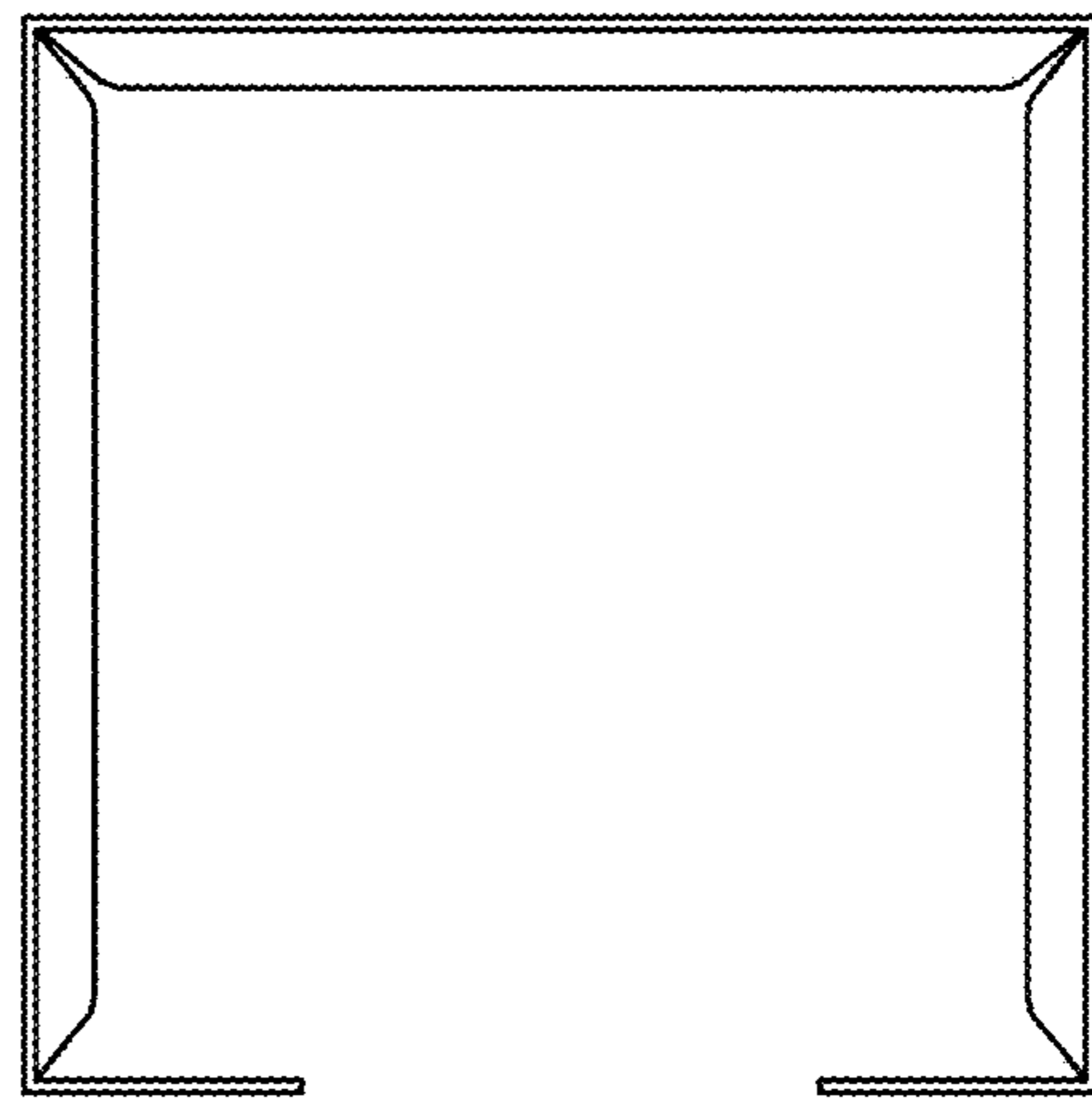

Fig. 4

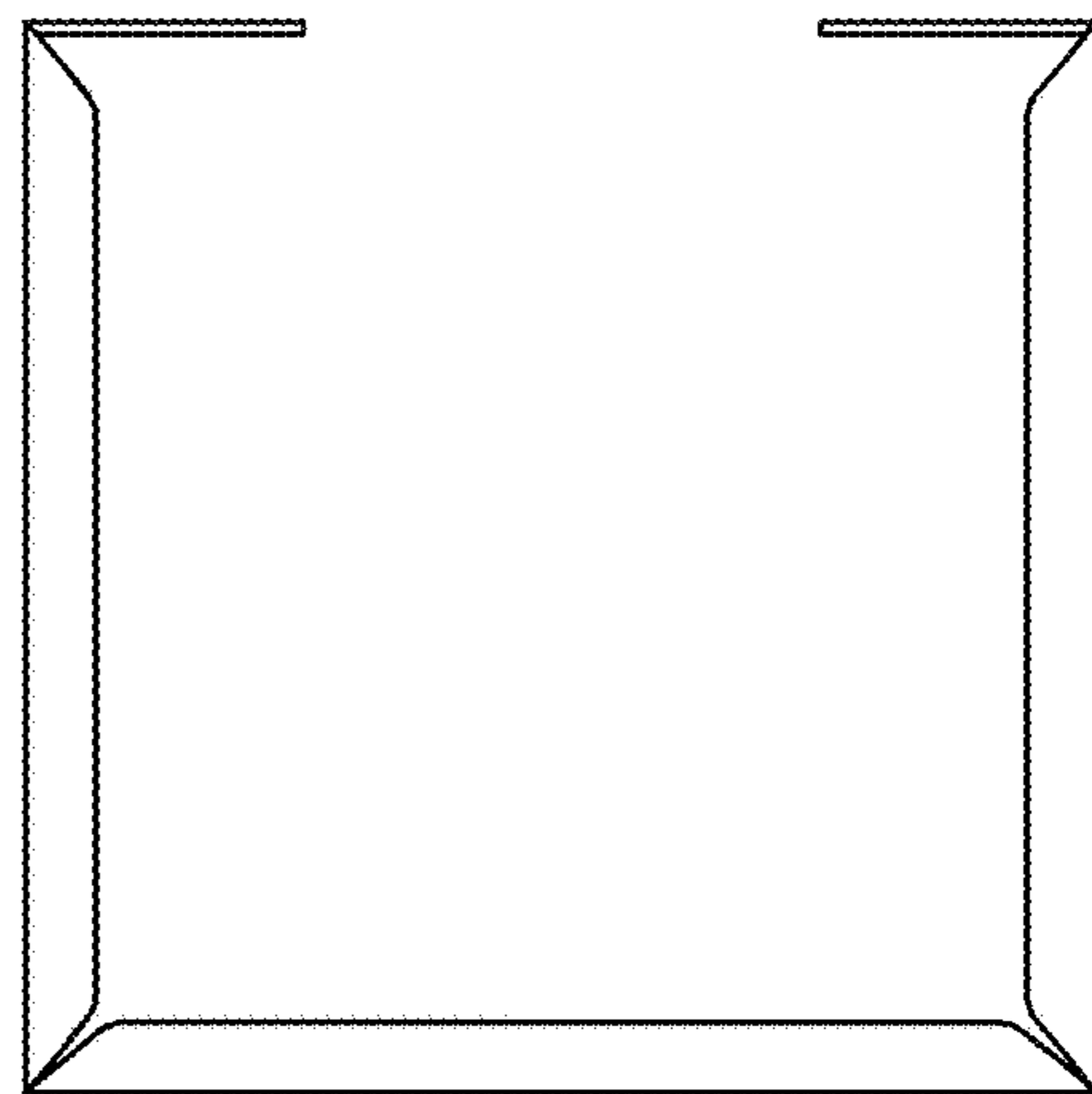

Fig. 5

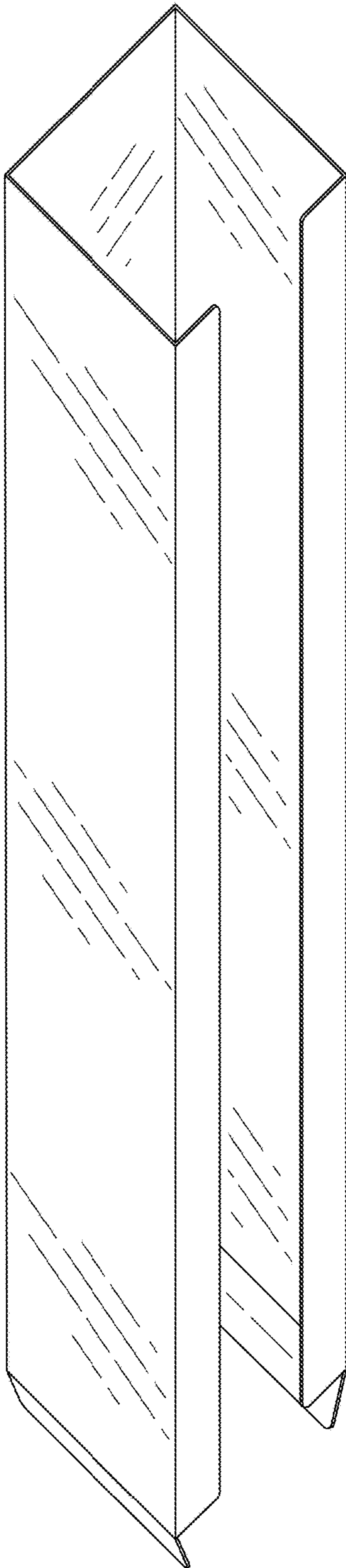

Fig. 6

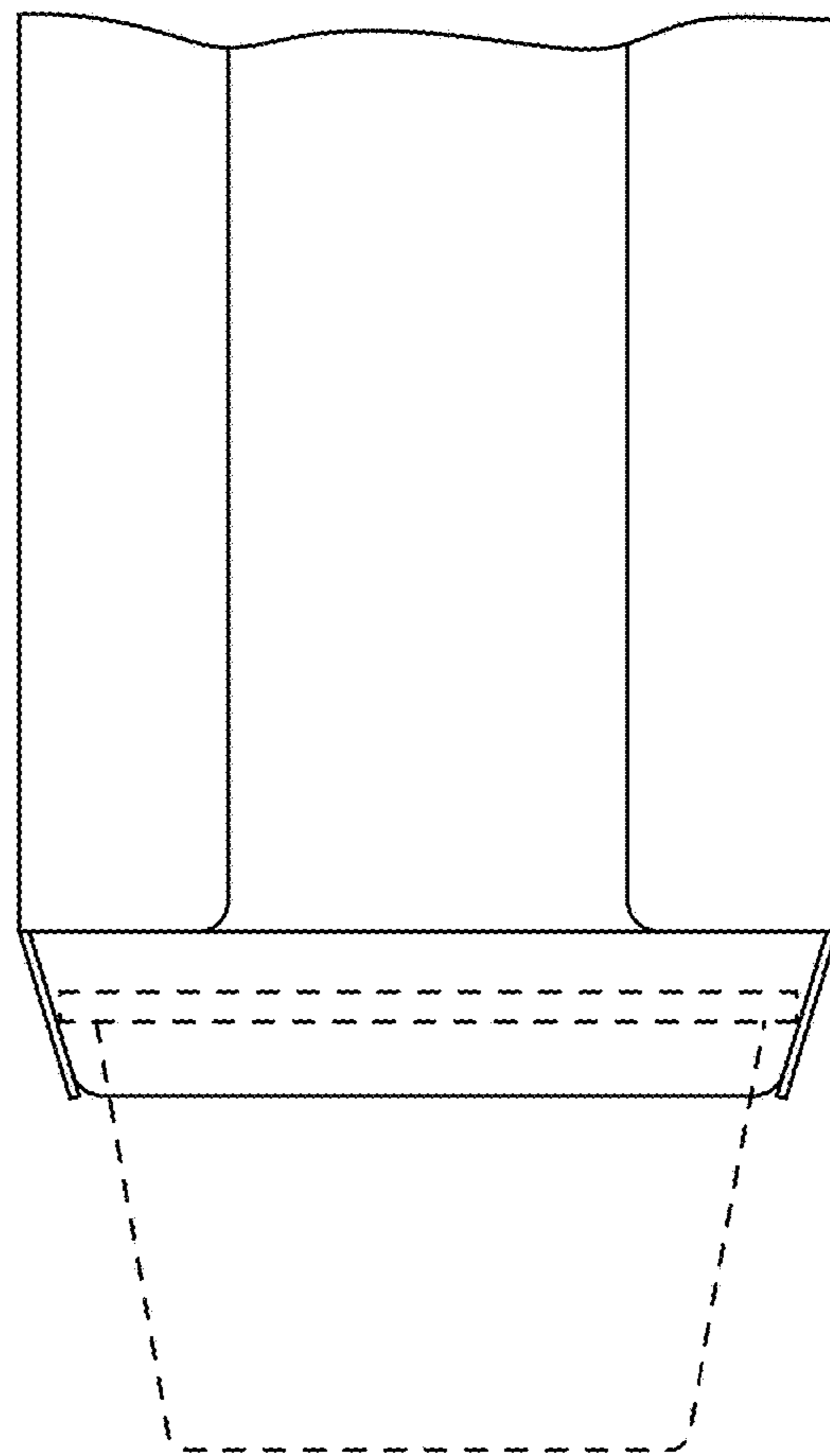

Fig. 7

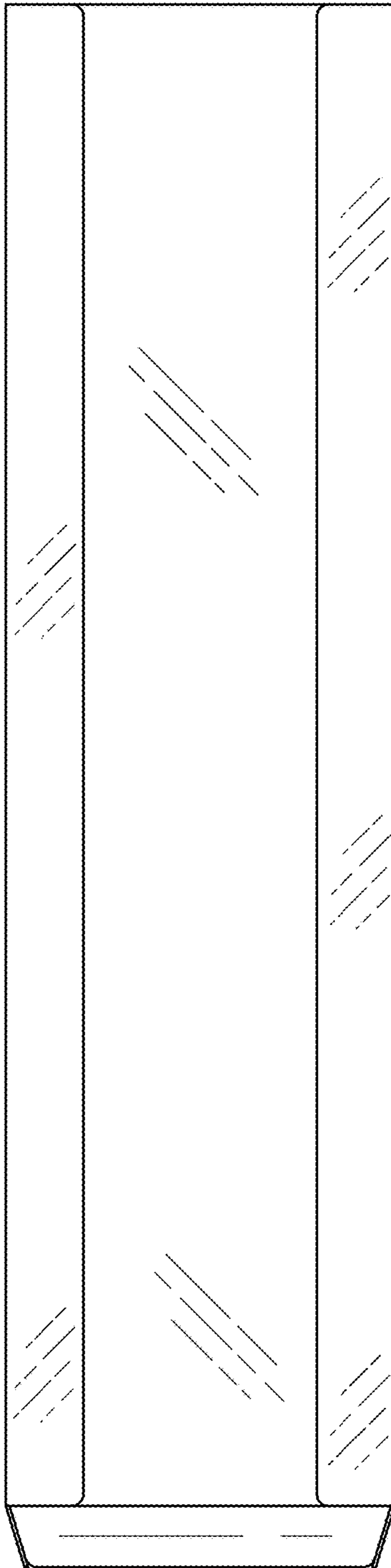

Fig. 8

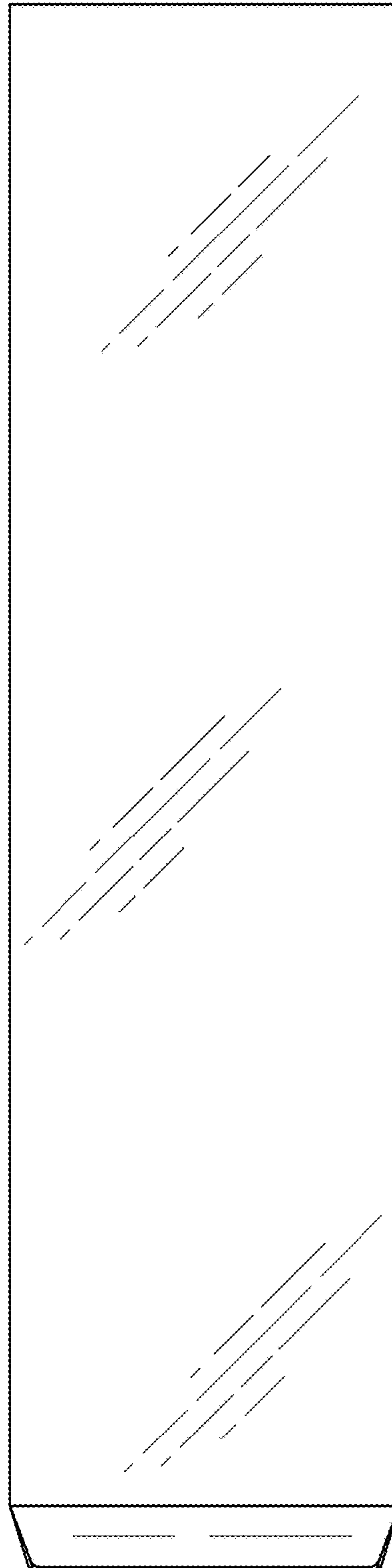

Fig. 9

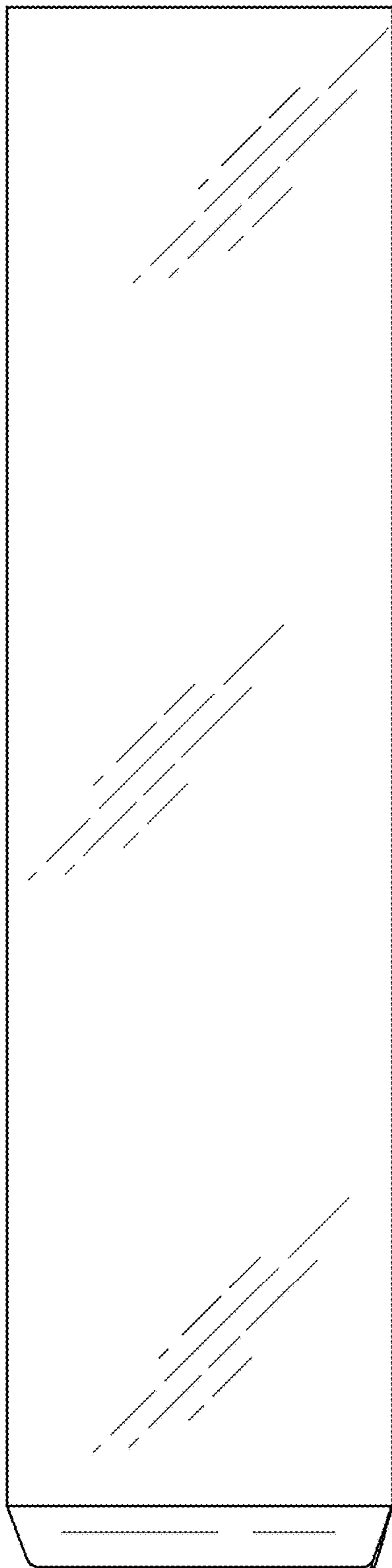

Fig. 10

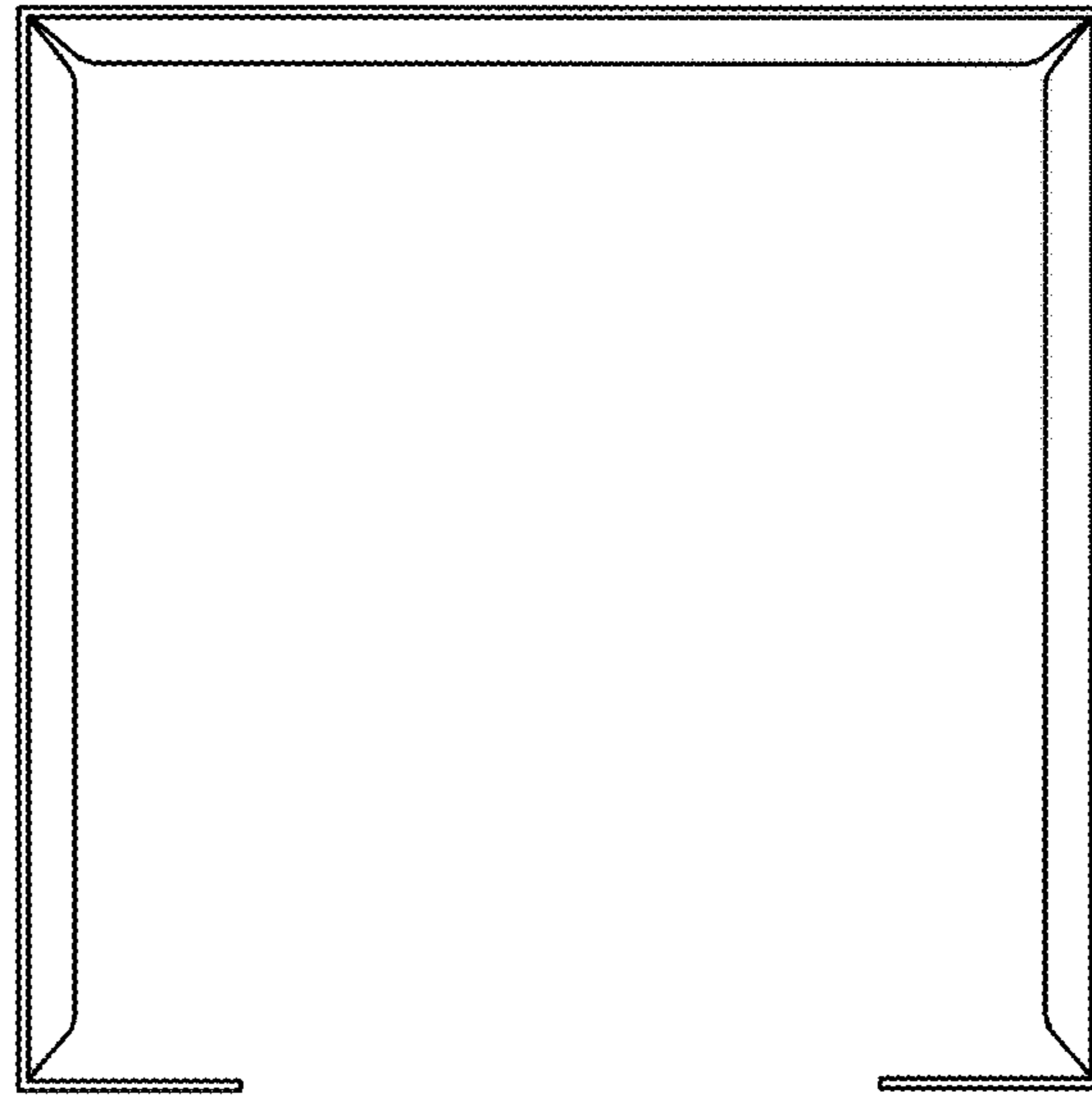

Fig. 11

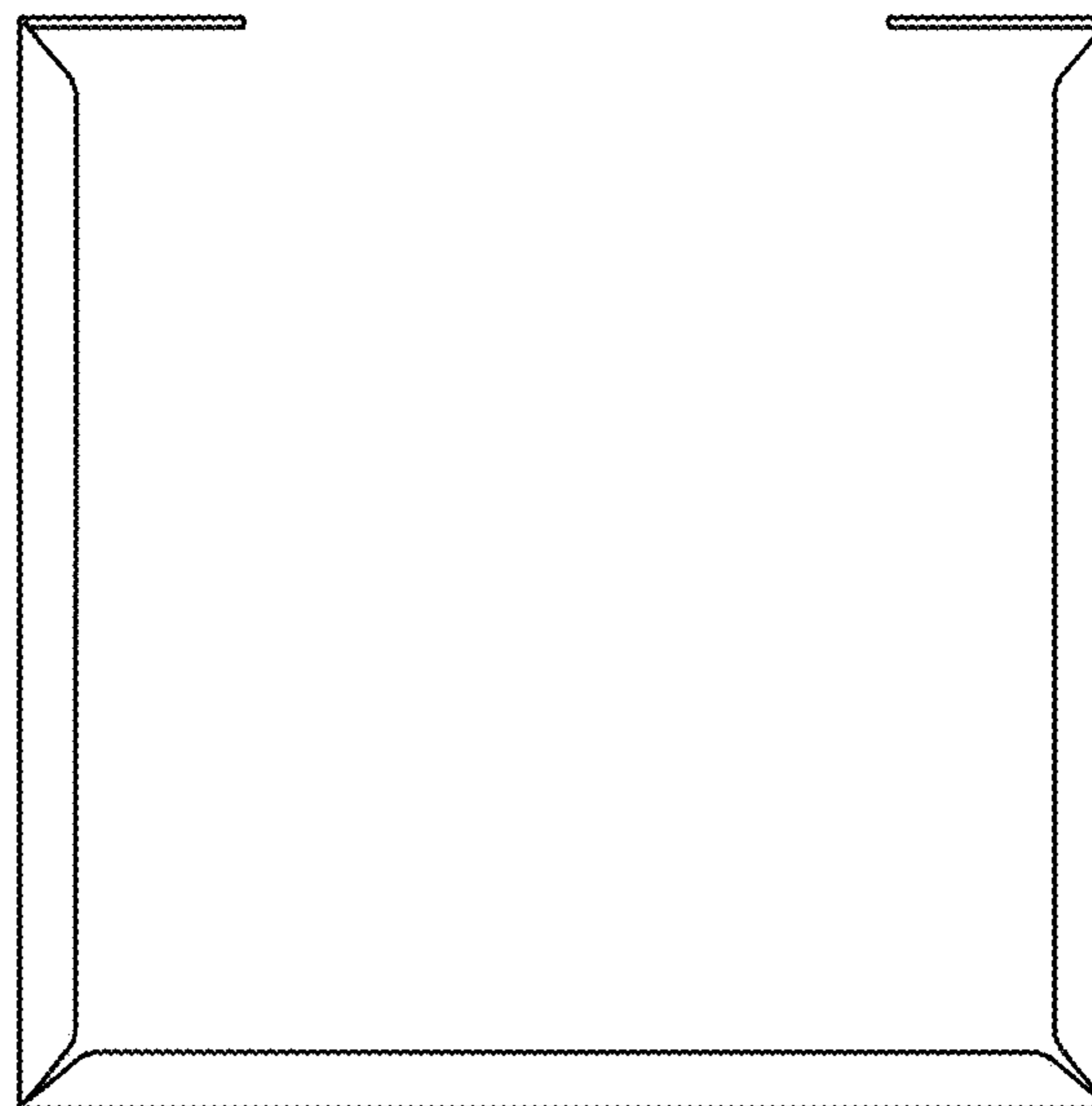

Fig. 12

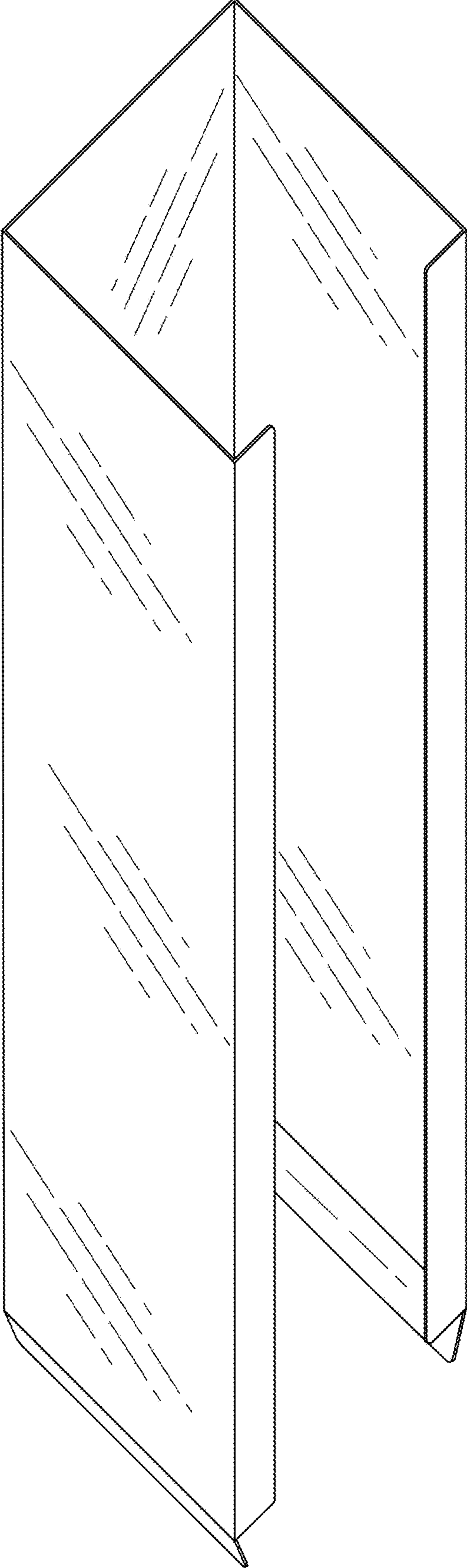

Fig. 13