



US00D779771S

(12) **United States Design Patent** (10) **Patent No.:** **US D779,771 S**  
**King et al.** (45) **Date of Patent:** **\*\* Feb. 21, 2017**

(54) **MULTISPACE PARKING PAY STATION**

19/202;G07F 19/203; G07F 19/204; G07F  
19/205; G07D 11/00; G07D  
11/0021; G07D 2201/00

(71) Applicant: **IPS Group Inc.**, San Diego, CA (US)

See application file for complete search history.

(72) Inventors: **David William King**, Rancho Santa Fe,  
CA (US); **Murray David Kirby  
Hunter**, Birchgrove (AU); **David  
Andrew Jones**, Beecroft (AU); **Choor  
Hong Tan**, Wentworth Point (AU);  
**Michael W. MacCollum**, Poway, CA  
(US); **Ron Lawrence**, San Diego, CA  
(US); **Anthony Babaran**, San Diego,  
CA (US)

(56)

**References Cited**

U.S. PATENT DOCUMENTS

D278,689 S 5/1985 Carlen  
4,754,126 A 6/1988 Caldwell  
5,065,156 A 11/1991 Bernier  
D336,860 S 6/1993 Clough  
D342,209 S 12/1993 Clough  
D360,734 S 7/1995 Hall

(Continued)

(73) Assignee: **IPS GROUP INC.**, San Diego, CA  
(US)

(\*\*) Term: **15 Years**

(21) Appl. No.: **29/548,020**

(22) Filed: **Dec. 9, 2015**

OTHER PUBLICATIONS

Co-pending U.S. Appl. No. 29/477,176, filed Dec. 19, 2013.

(Continued)

*Primary Examiner* — Elizabeth J Oswecki

(74) *Attorney, Agent, or Firm* — Wilson, Sonsini,  
Goodrich & Rosati

**Related U.S. Application Data**

(63) Continuation-in-part of application No. 29/477,321,  
filed on Dec. 20, 2013, now Pat. No. Des. 748,364.

(51) **LOC (10) Cl.** ..... **99-00**

(52) **U.S. Cl.**

USPC ..... **D99/28**

(58) **Field of Classification Search**

USPC .. D99/28, 34, 35, 36, 43, 99; D14/300–302,  
D14/305, 307, 900–902; D18/3.1–3.3,  
D18/4.1–4.6, 12.1–12.3; D21/324,  
D21/325, 329, 369, 370

CPC ..... G07B 1/00; G07B 1/02; G07B 1/04;  
G07B 1/06; G07B 1/08; G07B  
3/00; G07B 3/02; G07B 3/04; G07B  
5/00; E05B 65/0075; E05G 1/00; E05G  
1/005; E05G 1/02; E05G 1/024; E05G  
5/00; E05G 5/003; E05G 5/006; E05G  
5/02; E05G 7/00; E05G 7/001; E05G  
2700/00; E05G 2700/02; G07F  
19/00; G07F 19/20; G07F 19/201; G07F

(57)

**CLAIM**

The ornamental design for a multispace parking pay station,  
as shown and described.

**DESCRIPTION**

FIG. 1 is a top front perspective view of a multispace  
parking pay station, showing my new design;  
FIG. 2 is a front elevational view thereof;  
FIG. 3 is a rear elevational view thereof;  
FIG. 4 is a left side elevational view thereof;  
FIG. 5 is a right side elevational view thereof; and,  
FIG. 6 is a top plan view thereof.

The broken lines shown in the drawings represent portions  
of the multispace parking pay station that form no part of the  
claimed design.

All surfaces not shown form no part of the claimed design.

**1 Claim, 4 Drawing Sheets**

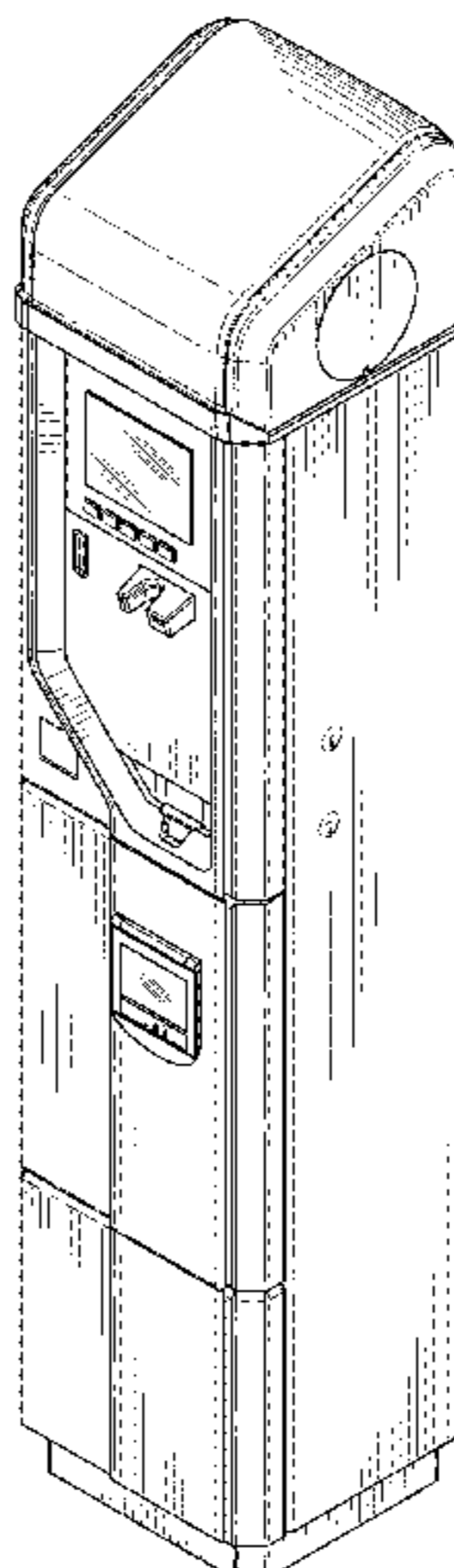

(56)

References Cited

U.S. PATENT DOCUMENTS

D375,607 S 11/1996 Hall  
 D396,655 S 8/1998 Anderson  
 5,915,246 A 6/1999 Patterson et al.  
 D412,289 S 7/1999 Winwood  
 6,029,888 A 2/2000 Harvey  
 D431,788 S 10/2000 Tuxen et al.  
 D437,468 S 2/2001 Fukutake et al.  
 6,230,868 B1 5/2001 Tuxen et al.  
 6,275,169 B1 8/2001 Krygler et al.  
 D448,910 S 10/2001 Kit  
 D450,253 S 11/2001 Marguet  
 D454,421 S 3/2002 Jeon  
 D460,005 S 7/2002 Jacquet  
 6,505,774 B1 1/2003 Fulcher et al.  
 D472,362 S 3/2003 Zerman et al.  
 6,527,172 B1 3/2003 Lewis et al.  
 D481,516 S 10/2003 Magee  
 D485,417 S 1/2004 Magee  
 D488,280 S 4/2004 Zerman  
 D492,080 S 6/2004 Magee  
 D492,081 S 6/2004 Magee  
 D494,730 S 8/2004 Magee  
 D497,814 S 11/2004 Odinotski et al.  
 D505,240 S 5/2005 Swaine et al.  
 D505,765 S 5/2005 Swaine et al.  
 D510,751 S 10/2005 Magee et al.  
 7,004,385 B1 2/2006 Douglass  
 7,019,670 B2 3/2006 Bahar  
 7,028,888 B2 4/2006 Laskowski et al.  
 7,040,534 B2 5/2006 Turocy et al.  
 D530,880 S 10/2006 Magee et al.  
 7,131,576 B2 11/2006 Utz et al.  
 D538,505 S 3/2007 Kang  
 7,222,782 B2 5/2007 Lute, Jr. et al.  
 7,284,692 B1 10/2007 Douglass  
 D570,920 S 6/2008 Choi  
 7,419,091 B1 9/2008 Scanlon  
 D579,795 S 11/2008 Martinez et al.  
 7,445,144 B2 11/2008 Schlabach et al.  
 D582,125 S 12/2008 Kang et al.  
 D592,825 S 5/2009 Kang et al.  
 7,533,802 B1 5/2009 McGinley et al.  
 D596,373 S 7/2009 Kang et al.  
 D596,374 S 7/2009 Kang  
 7,575,166 B2 8/2009 McNamara  
 7,611,045 B1 11/2009 Lute et al.  
 7,624,919 B2 12/2009 Meek et al.  
 7,699,224 B2 4/2010 Mole  
 D615,274 S 5/2010 Kim et al.  
 7,717,327 B2 5/2010 Gomes et al.  
 7,726,558 B1 \* 6/2010 Lute ..... G07F 19/20  
 235/379  
 D625,305 S 10/2010 Bleck  
 D629,585 S 12/2010 Bleck et al.  
 D632,740 S 2/2011 Adeline  
 7,891,546 B1 2/2011 Steinbach et al.  
 D645,223 S 9/2011 Bleck  
 D652,872 S 1/2012 Mougin et al.  
 D653,014 S 1/2012 Rohan  
 D653,420 S 1/2012 Rohan  
 D653,421 S 1/2012 Rohan  
 D653,424 S 1/2012 Rohan  
 8,181,857 B1 \* 5/2012 Lute ..... G06Q 20/1085  
 235/379  
 D672,525 S 12/2012 Lee et al.  
 D674,985 S 1/2013 Lee  
 D677,035 S 2/2013 Lee  
 D677,714 S 3/2013 Helgesson et al.  
 D680,156 S 4/2013 Hernandez et al.  
 D681,717 S 5/2013 Helgesson et al.  
 D682,504 S 5/2013 Lee et al.  
 D684,745 S 6/2013 Reuter  
 D691,165 S 10/2013 Attoma

D693,983 S 11/2013 Budde et al.  
 8,573,484 B1 \* 11/2013 Irudayam ..... G07F 19/201  
 235/375  
 D696,484 S 12/2013 Lee  
 D696,485 S 12/2013 Lee  
 D702,913 S 4/2014 Budde  
 D702,914 S 4/2014 Budde  
 D716,515 S 10/2014 Cha  
 D722,740 S 2/2015 Budde  
 D724,290 S 3/2015 Cha et al.  
 D724,811 S 3/2015 Reitingner  
 D724,812 S 3/2015 Cha et al.  
 D728,190 S 4/2015 Sheley  
 D732,263 S 6/2015 Budde et al.  
 D735,437 S 7/2015 Randall  
 D735,438 S 7/2015 Randall  
 D735,439 S 7/2015 Randall  
 D735,440 S 7/2015 Randall  
 D735,963 S 8/2015 Randall  
 D735,964 S 8/2015 Randall  
 D735,965 S 8/2015 Randall  
 D739,637 S 9/2015 Randall  
 D739,638 S \* 9/2015 Randall ..... D99/28  
 D739,639 S \* 9/2015 Randall ..... D99/28  
 D741,040 S 10/2015 Budde et al.  
 D742,090 S 10/2015 Randall  
 D743,956 S \* 11/2015 Kraft ..... D14/307  
 D746,015 S \* 12/2015 King ..... D99/28  
 D748,364 S \* 1/2016 King ..... D99/28  
 D748,888 S \* 2/2016 King ..... D99/28  
 D749,290 S 2/2016 Pollmann  
 D762,040 S \* 7/2016 King ..... D99/28  
 D769,570 S \* 10/2016 Kraft ..... D99/28  
 D769,571 S \* 10/2016 Lee ..... D99/28  
 D769,572 S \* 10/2016 Park ..... D99/28  
 2004/0016796 A1 1/2004 Hanna et al.  
 2004/0243526 A1 12/2004 Krygler et al.  
 2004/0262379 A1 12/2004 Gomes et al.  
 2005/0029340 A1 2/2005 Ferraro  
 2006/0152385 A1 7/2006 Mandy  
 2007/0046651 A1 3/2007 Sinclair et al.  
 2007/0276724 A1 11/2007 Catt  
 2008/0257965 A1 10/2008 Klein et al.  
 2008/0265019 A1 10/2008 Artino et al.  
 2008/0296365 A1 12/2008 Schliebe  
 2009/0057398 A1 3/2009 Douglass et al.  
 2010/0161489 A1 6/2010 Goodall et al.  
 2010/0187300 A1 7/2010 Ramachandran et al.  
 2010/0241564 A1 9/2010 Miller et al.  
 2010/0243729 A1 9/2010 Russell et al.  
 2011/0133613 A1 6/2011 Descamps et al.  
 2012/0286036 A1 11/2012 Jones et al.

OTHER PUBLICATIONS

Co-pending U.S. Appl. No. 29/477,201, filed Dec. 19, 2013.  
 Co-pending U.S. Appl. No. 29/477,024, filed Dec. 19, 2013.  
 Co-pending U.S. Appl. No. 29/477,321, filed Dec. 20, 2013.  
 Co-pending U.S. Appl. No. 29/477,324, filed Dec. 20, 2013.  
 Co-pending U.S. Appl. No. 29/477,329, filed Dec. 20, 2013.  
 Co-pending U.S. Appl. No. 29/545,046, filed Nov. 9, 2015.  
 Co-pending U.S. Appl. No. 29/545,062, filed Nov. 9, 2015.  
 Co-pending U.S. Appl. No. 29/548,022, filed Dec. 9, 2015.  
 Co-pending U.S. Appl. No. 29/548,023, filed Dec. 9, 2015.  
 Co-pending U.S. Appl. No. 29/548,024, filed Dec. 9, 2015.  
 U.S. Appl. No. 29/477,176 Office Action dated May 4, 2015.  
 U.S. Appl. No. 29/477,200 Office Action dated Apr. 9, 2015.  
 U.S. Appl. No. 29/477,201 Office Action dated Apr. 9, 2015.  
 U.S. Appl. No. 29/477,204 Office Action dated Apr. 9, 2015.  
 U.S. Appl. No. 29/477,321 Office Action dated May 15, 2015.  
 U.S. Appl. No. 29/477,324 Office Action dated Apr. 23, 2015.  
 U.S. Appl. No. 29/477,329 Office Action dated May 22, 2015.  
 U.S. Appl. No. 29/477,402 Office Action dated Apr. 9, 2015.

\* cited by examiner



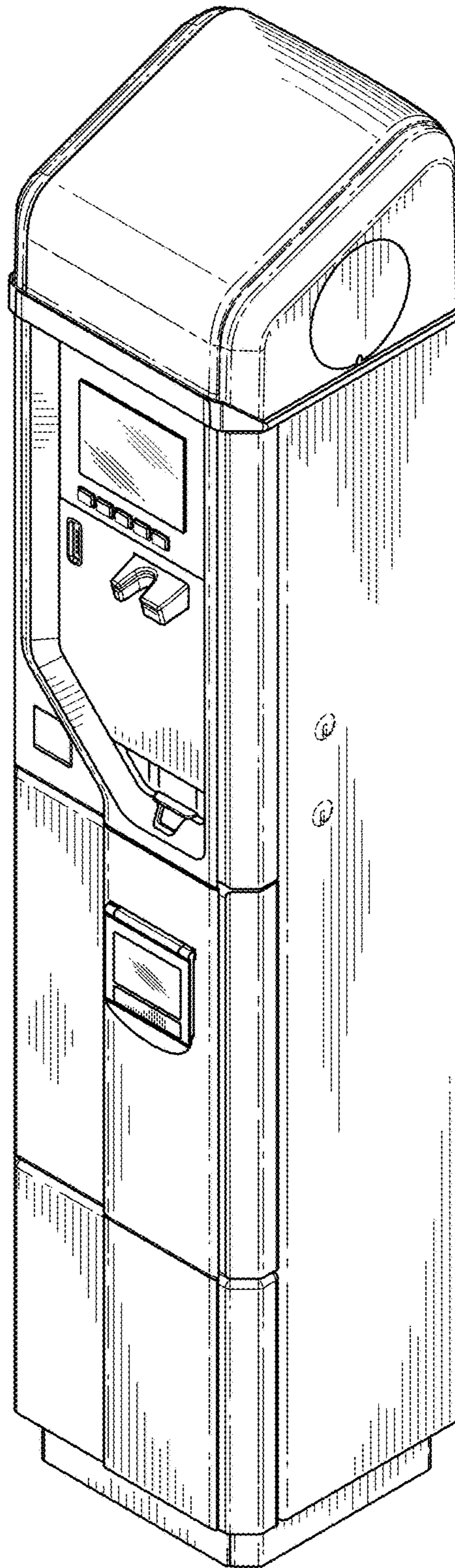

FIG. 1

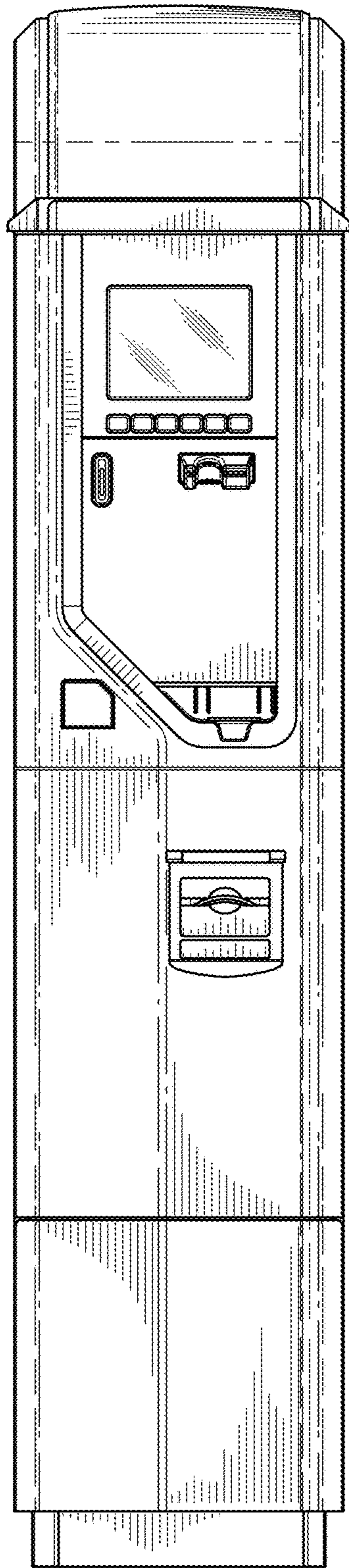

FIG. 2

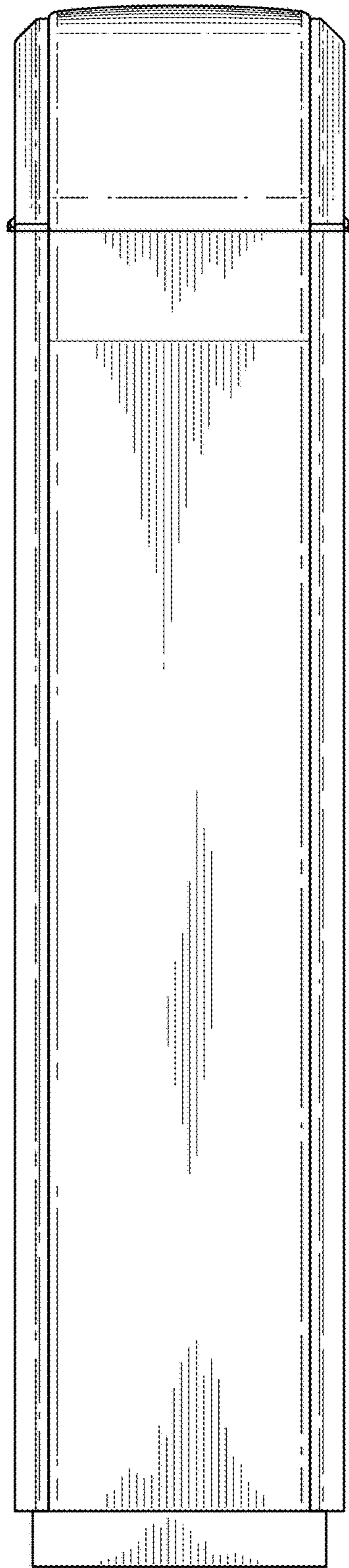

FIG. 3

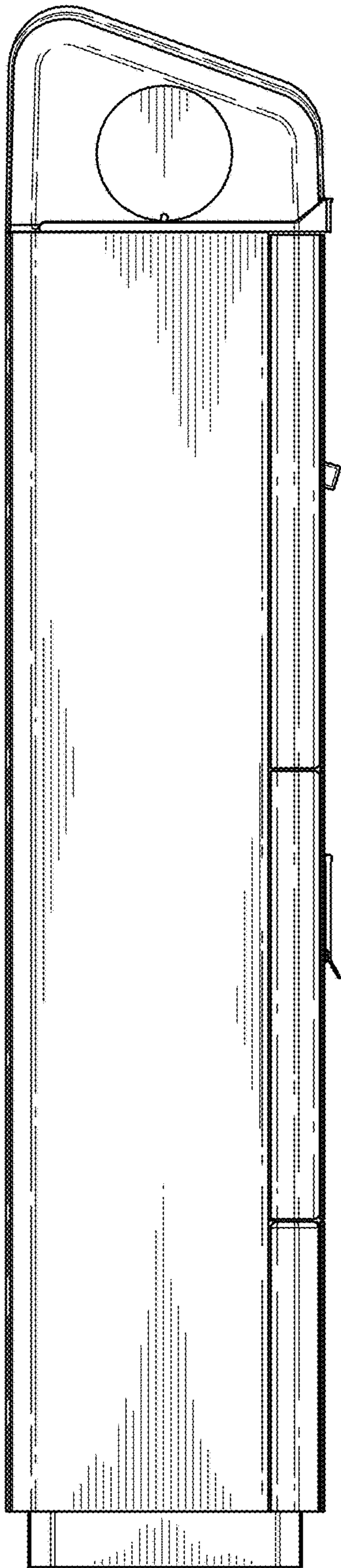

FIG. 4

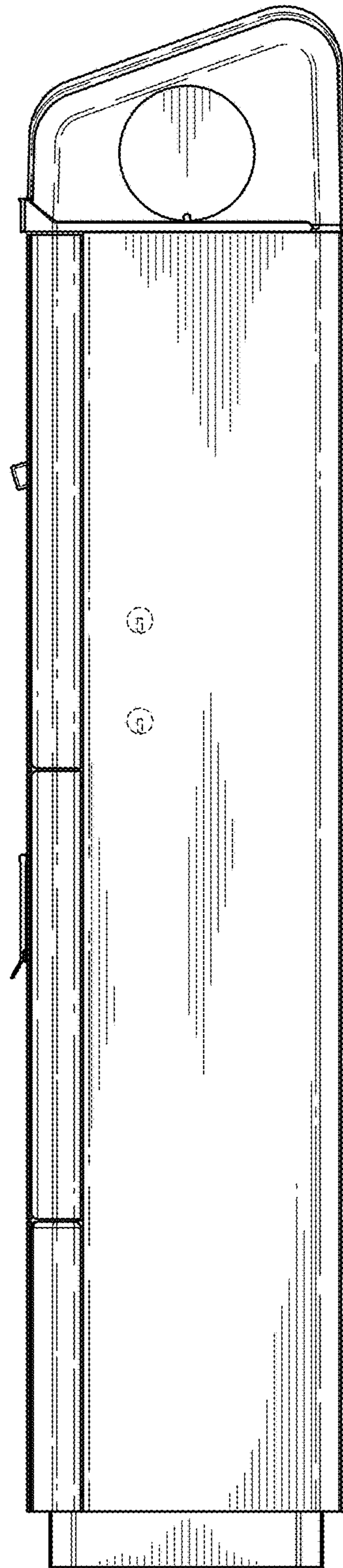

FIG. 5



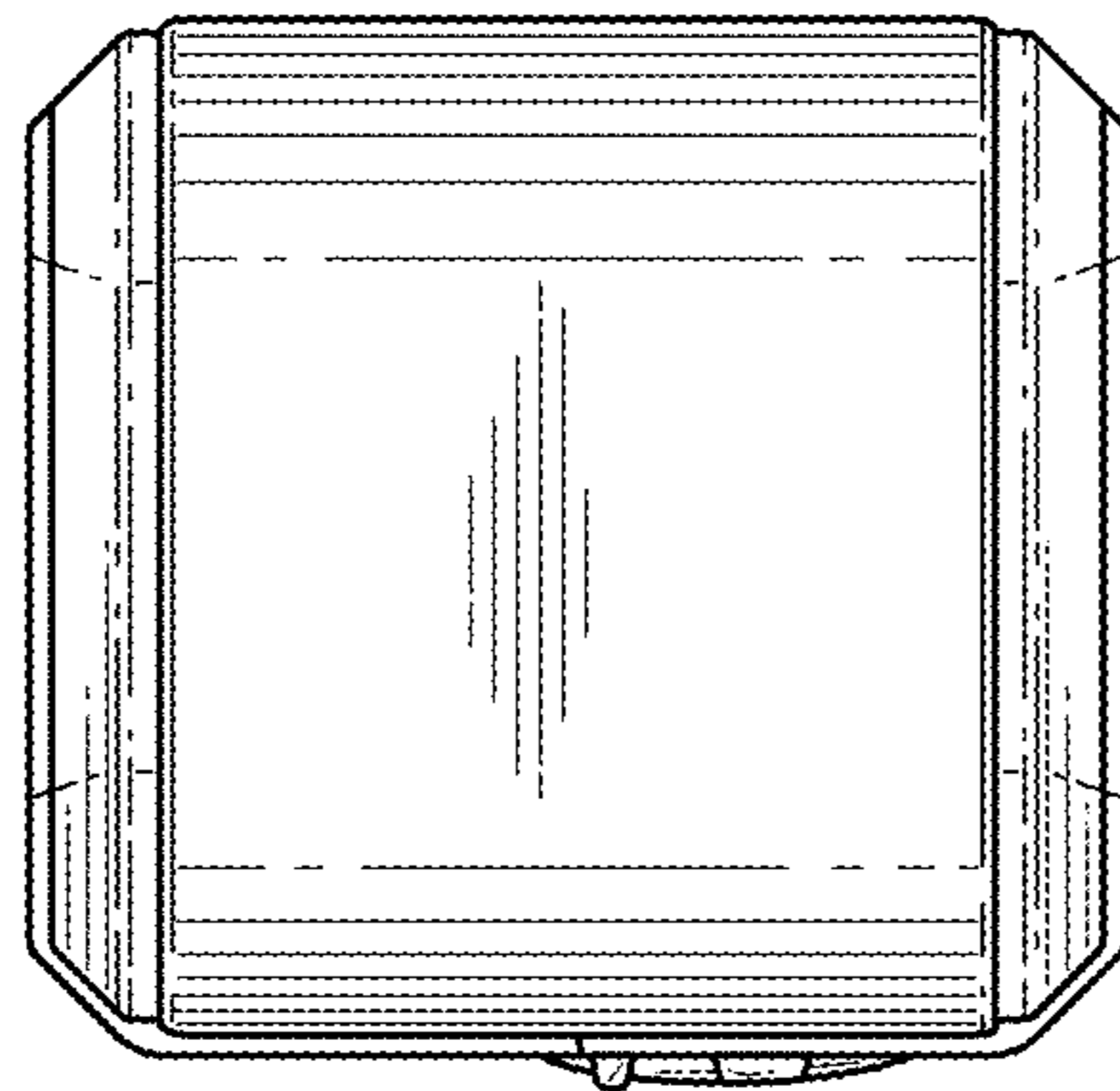

FIG. 6