



US00D779761S

(12) **United States Design Patent** (10) **Patent No.:** **US D779,761 S**
Bergemann et al. (45) **Date of Patent:** **** Feb. 21, 2017**

(54) **RECEPTACLE**

- (71) Applicant: **The Prestwick Group, Inc.**, Sussex, WI (US)
- (72) Inventors: **Jason Bergemann**, Milwaukee, WI (US); **Tyler Morse**, Nashotah, WI (US)
- (73) Assignee: **The Prestwick Group, Inc.**, Sussex, WI (US)
- (**) Term: **15 Years**
- (21) Appl. No.: **29/535,458**
- (22) Filed: **Aug. 6, 2015**

Related U.S. Application Data

- (62) Division of application No. 29/475,679, filed on Dec. 5, 2013, now Pat. No. Des. 738,588.
- (51) **LOC (10) Cl.** **09-09**
- (52) **U.S. Cl.**
USPC **D34/7**
- (58) **Field of Classification Search**
USPC D34/1-11; 220/908, 908.1, 909, 911;
232/43.1, 43.2
CPC B65F 1/1426; B65F 1/1405; B65F 1/1415;
B65F 1/14; B65F 1/067; B65F 1/0033
See application file for complete search history.

(56) **References Cited**

U.S. PATENT DOCUMENTS

3,893,615 A	7/1975	Johnson
D292,037 S	9/1987	Hanifl
5,085,342 A	2/1992	Strawder
D326,341 S	5/1992	Frauhiger
5,174,468 A	12/1992	Holderman

(Continued)

OTHER PUBLICATIONS

Max-R website material, Busser Stations, available at <http://www.max-r.net/store/busser-stations.asp>, illustrating products publically available prior to Dec. 5, 2013, accessed on Jan. 27, 2014, 1 page.

(Continued)

Primary Examiner — Cynthia Ramirez

(74) *Attorney, Agent, or Firm* — Reinhart Boerner Van Deuren s.c.

(57) **CLAIM**

We claim the ornamental design for a receptacle, as shown and described.

DESCRIPTION

FIG. 1 is a perspective view from above of a receptacle showing our new design;
 FIG. 2 is a perspective view from below thereof;
 FIG. 3 is a top plan view thereof;
 FIG. 4 is a bottom plan view thereof;
 FIG. 5 is a front elevational view thereof;
 FIG. 6 is a rear elevational view thereof;
 FIG. 7 is a right side elevational view thereof;
 FIG. 8 is a left side elevational view thereof;
 FIG. 9 is a perspective view from above of another embodiment of a receptacle;
 FIG. 10 is a perspective view from below thereof;
 FIG. 11 is a top plan view thereof;
 FIG. 12 is a bottom plan view thereof;
 FIG. 13 is a front elevational view thereof;
 FIG. 14 is a rear elevational view thereof;
 FIG. 15 is a right side elevational view thereof; and,
 FIG. 16 is a left side elevational view thereof.

The broken lines shown in the figures are included for the purpose of illustrating portions of the receptacle and forms no part of the claimed design.

1 Claim, 14 Drawing Sheets

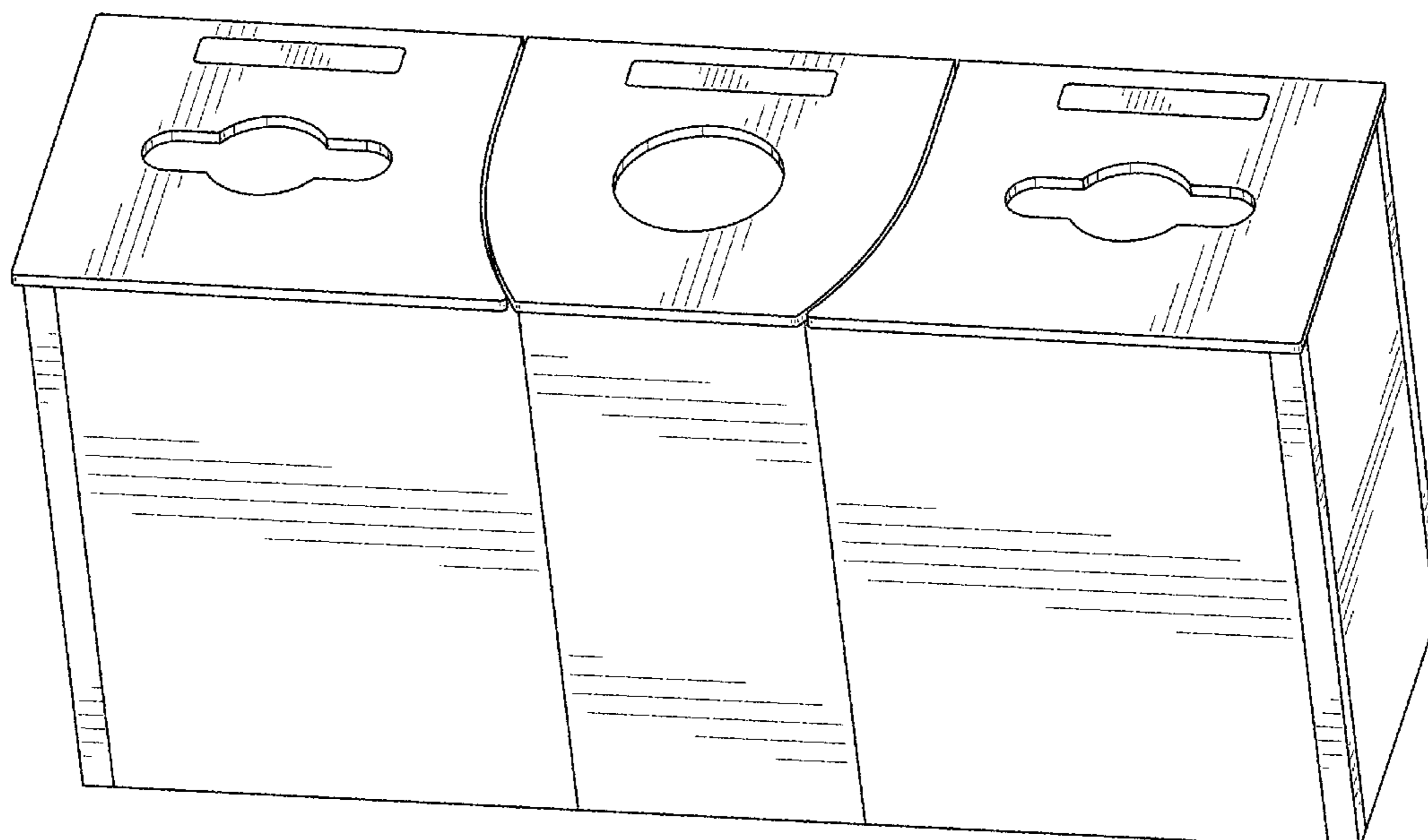

(56)

References Cited

U.S. PATENT DOCUMENTS

D332,332 S	1/1993	Markey	
D333,542 S	2/1993	McKenzie	
D334,852 S	4/1993	Beirise	
D335,012 S	4/1993	Broussard	
D335,730 S	5/1993	Tessner et al.	
D339,438 S	9/1993	Moran	
D344,381 S	2/1994	Martin et al.	
D356,419 S	3/1995	Kamm	
D423,167 S	4/2000	Welch	
D431,733 S	10/2000	Zimmerman	
D477,474 S	7/2003	Milligan	
D535,447 S	1/2007	Olivetti	
D545,590 S	7/2007	Good	
D586,521 S	2/2009	Pho et al.	
D591,470 S	4/2009	Tuncel	
D596,819 S	7/2009	Mancini	
D605,822 S	12/2009	Cantrell et al.	
D606,272 S	12/2009	Cantrell et al.	
D639,518 S	6/2011	Zeulner	
D681,301 S	4/2013	Bennie et al.	
D738,588 S *	9/2015	Bergemann	D34/7
2014/0291328 A1	10/2014	Jarrett et al.	

OTHER PUBLICATIONS

Max-R website material, Restaurants, available at http://www.max-r.net/cafeateria_restuarants.asp, illustrating products publically available prior to Dec. 5, 2013, accessed on Jan. 27, 2014, 2 pages.

Max-R website material, Max-R's Halston Collection—Recycling Bins, Waste Bins, available at http://www.max-r.net/store/halston_collection.asp, illustrating products publically available prior to Dec. 5, 2013, accessed on Jan. 27, 2014, 2 pages.

Max-R website material, Lamboo® Material, available at <http://www.max-r.net/lamboo.asp>, illustrating products publically available prior to Dec. 5, 2013, accessed on Jan. 27, 2014, 2 pages.

Max-R website material, Oxford Collection—Recycling Bins, Waste Bins, available at http://www.max-r.net/store/oxford_collection.asp, illustrating products publically available prior to Dec. 5, 2013, accessed on Jan. 27, 2014, 2 pages.

Max-R website material, Max-R's Terra Collection—Recycling Bins, Waste Bins, available at http://www.max-r.net/store/terra_collection.asp, illustrating products publically available prior to Dec. 5, 2013, accessed on Jan. 27, 2014, 2 pages.

Max-R website material, Towel Stations, available at <http://www.max-r.net/store/towel-stations.asp>, illustrating products publically available prior to Dec. 5, 2013, accessed on Jan. 27, 2014, 1 page.

Max-R website material, Tuscany Collection—Waste Recycling Bins, available at http://www.max-r.net/store/tuscany_collection.asp, illustrating products publically available prior to Dec. 5, 2013, accessed on Jan. 27, 2014, 2 pages.

Max-R website material, Max-R's Verde Collection—Recycling Bins, Waste Bins, available at http://www.max-r.net/store/verde_collection.asp, illustrating products publically available prior to Dec. 5, 2013, accessed on Jan. 27, 2014, 2 pages.

Max-R website material, Waste and Recycling Bins p. 1, available at <http://www.max-r.net/store/waste-and-recycling-bins.asp>, illustrating products publically available prior to Dec. 5, 2013, accessed on Jan. 27, 2014, 2 pages.

Max-R website material, Waste and Recycling Bins p. 2, available at <http://www.max-r.net/store/waste-and-recycling-bins.asp>, illustrating products publically available prior to Dec. 5, 2013, accessed on Jan. 27, 2014, 2 pages.

Max-R website material, Waste and Recycling Bins p. 3, available at <http://www.max-r.net/store/waste-and-recycling-bins.asp>, illustrating products publically available prior to Dec. 5, 2013, accessed on Jan. 27, 2014, 2 pages.

Max-R website material, Waste and Recycling Bins p. 4, available at <http://www.max-r.net/store/waste-and-recycling-bins.asp>, illustrating products publically available prior to Dec. 5, 2013, accessed on Jan. 27, 2014, 2 pages.

Max-R website material, Waste and Recycling Bins p. 5, available at <http://www.max-r.net/store/waste-and-recycling-bins.asp>, illustrating products publically available prior to Dec. 5, 2013, accessed on Jan. 27, 2014, 2 pages.

Max-R website material, Waste and Recycling Bins p. 6, available at <http://www.max-r.net/store/waste-and-recycling-bins.asp>, illustrating products publically available prior to Dec. 5, 2013, accessed on Jan. 27, 2014, 2 pages.

Max-R website material, Waste and Recycling Bins p. 7, available at <http://www.max-r.net/store/waste-and-recycling-bins.asp>, illustrating products publically available prior to Dec. 5, 2013, accessed on Jan. 27, 2014, 2 pages.

Max-R website material, Waste and Recycling Bins p. 8, available at <http://www.max-r.net/store/waste-and-recycling-bins.asp>, illustrating products publically available prior to Dec. 5, 2013, accessed on Jan. 27, 2014, 2 pages.

Waste/Recycle Unit Specifications and Bin and Meeting Room Waste/Recycle Bin Concept Drawings, conceived of and drawn by third party, dated May 7, 2012, 3 pages.

* cited by examiner

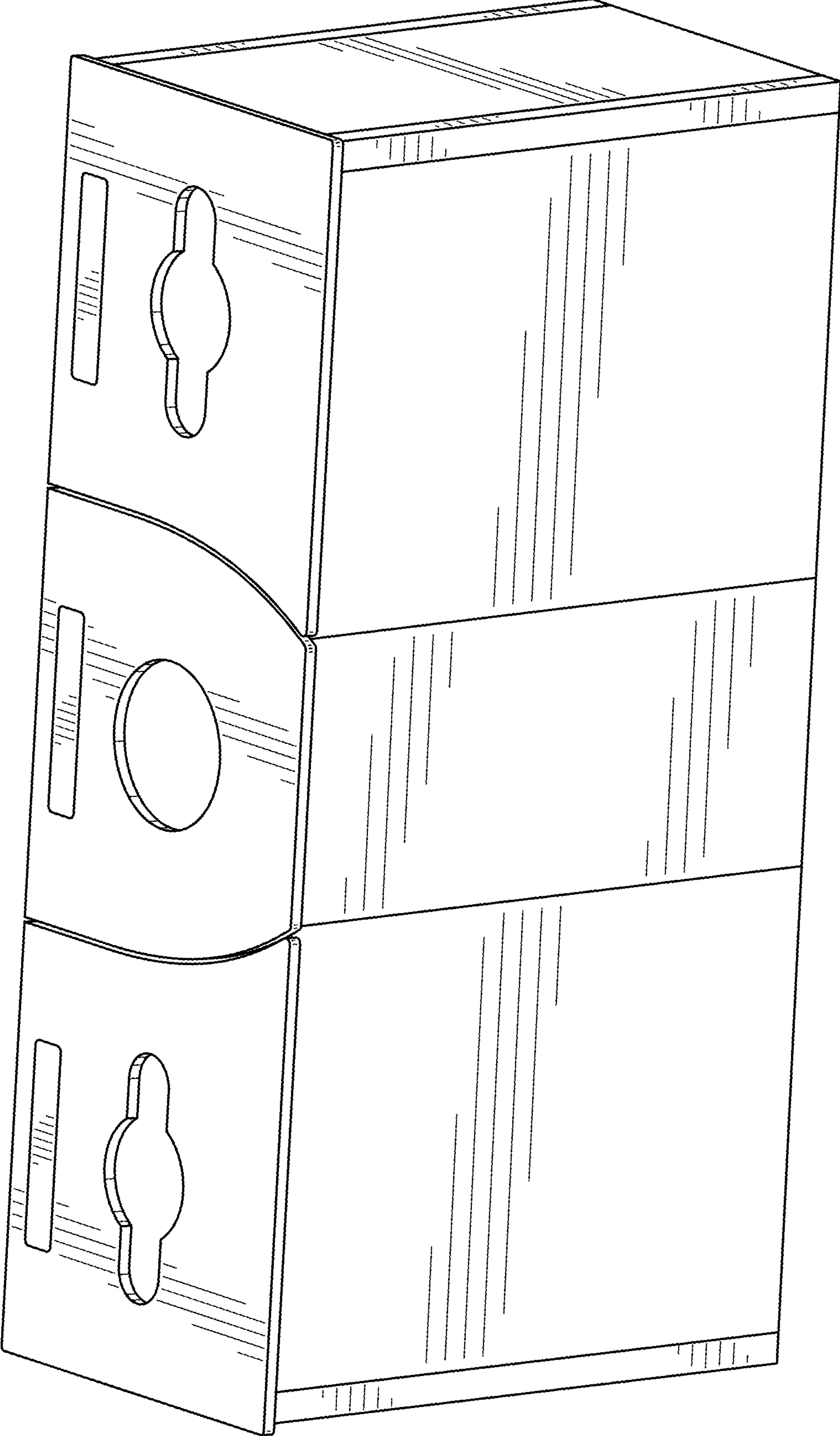

FIG. 1

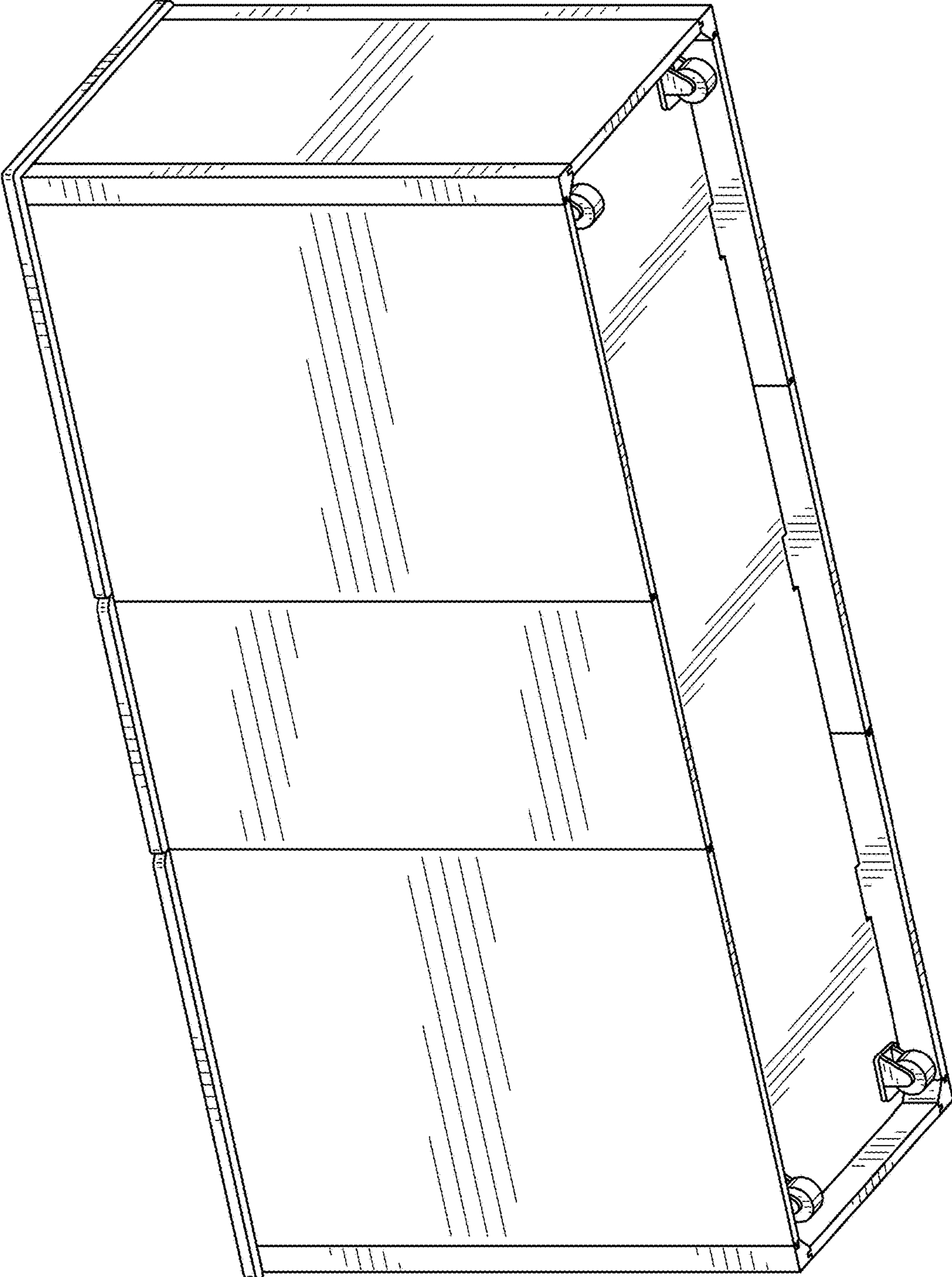

FIG. 2

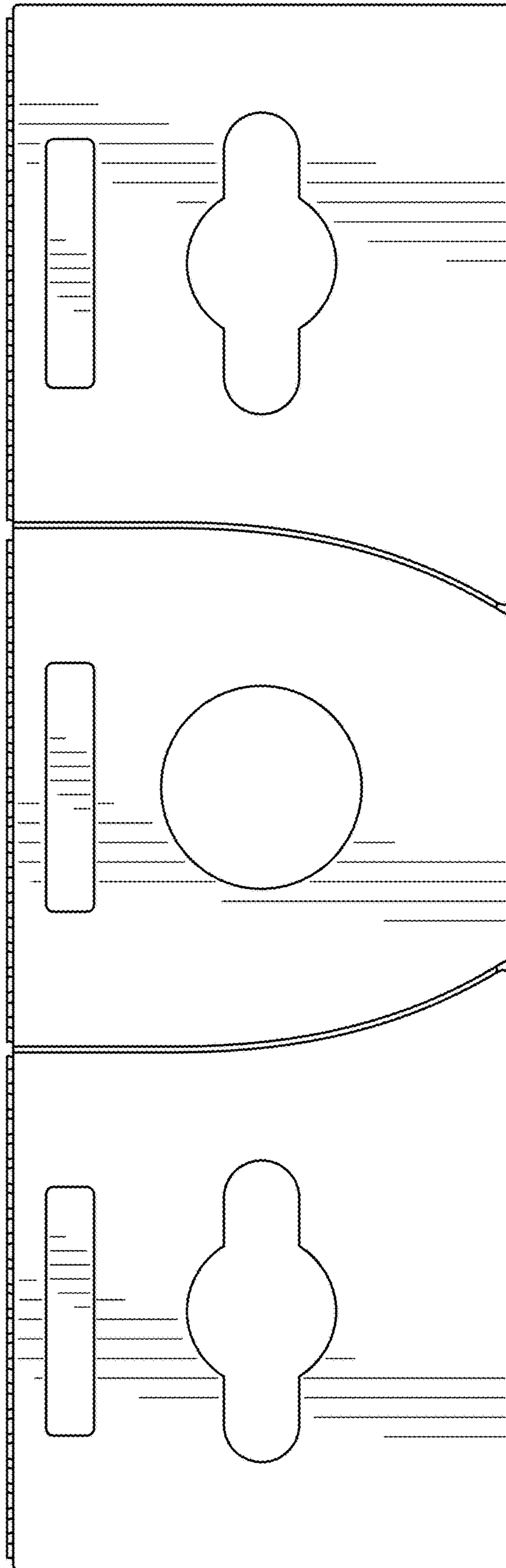

FIG. 3

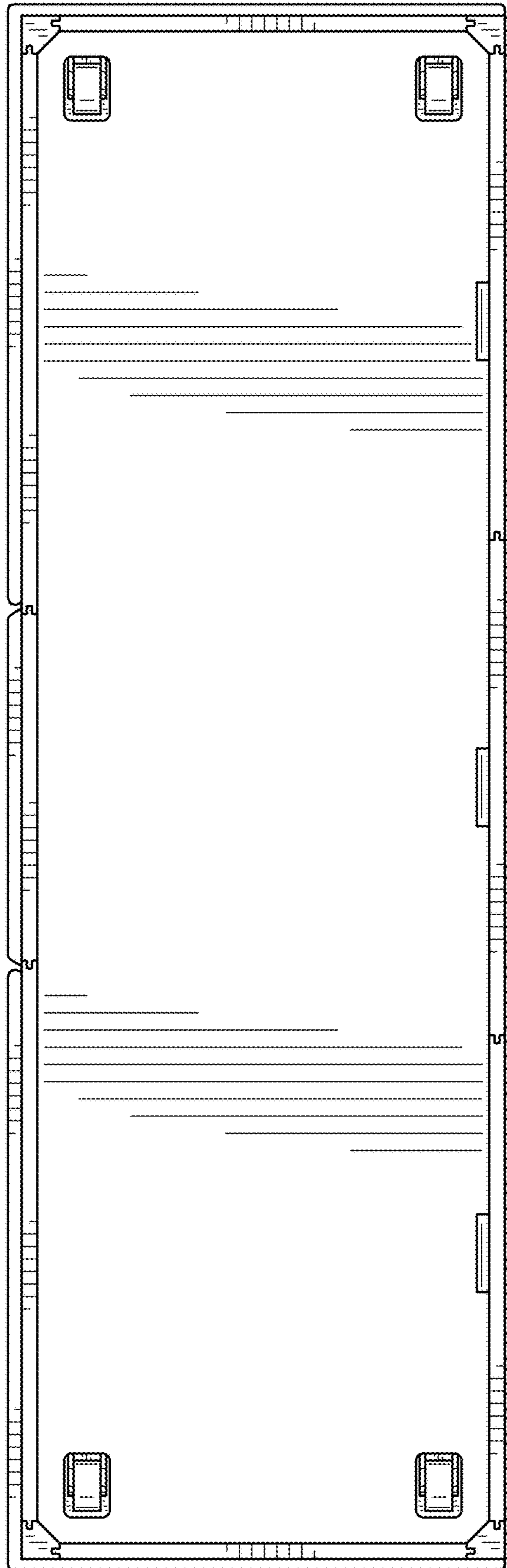

FIG. 4

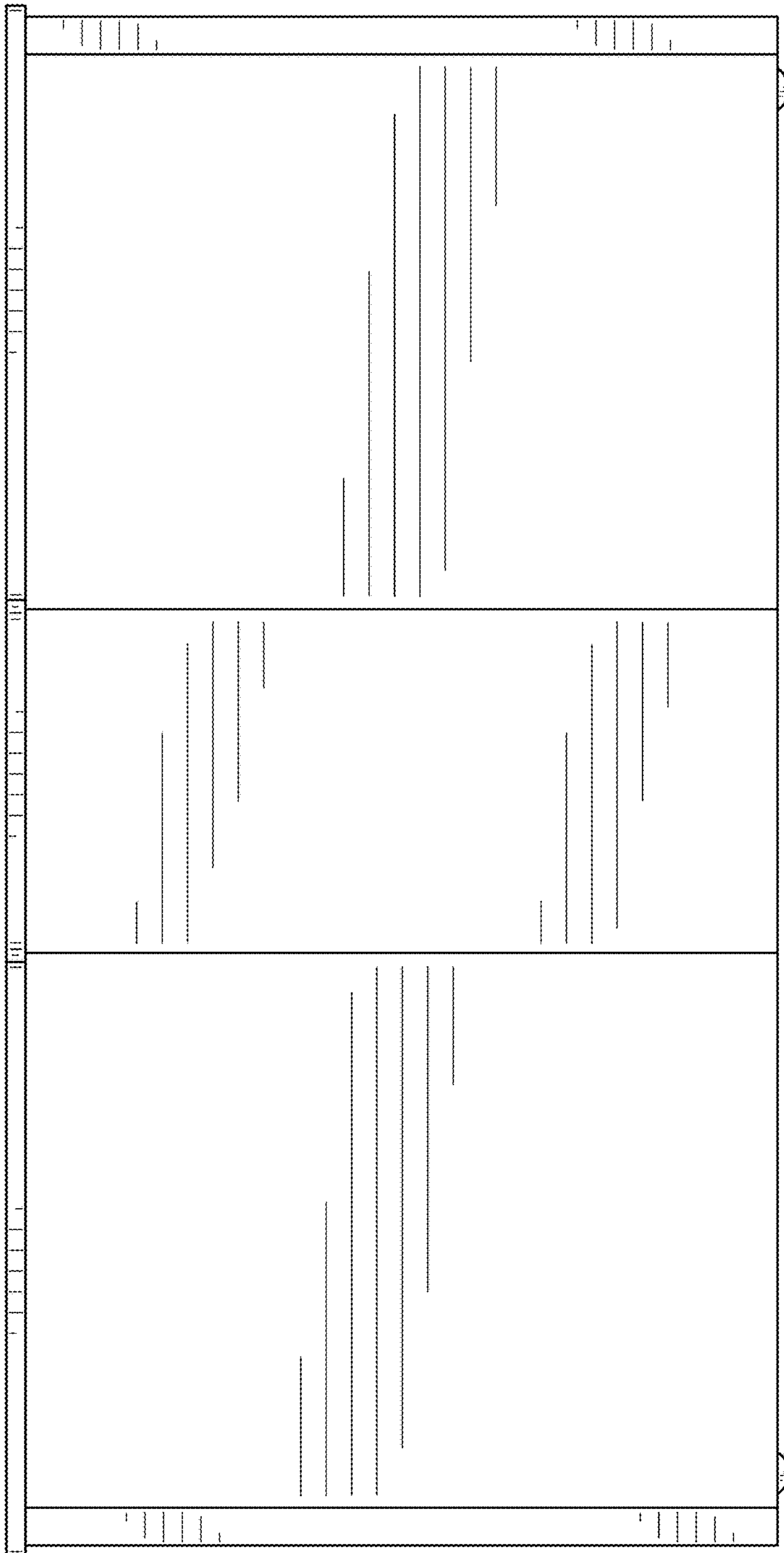

FIG. 5

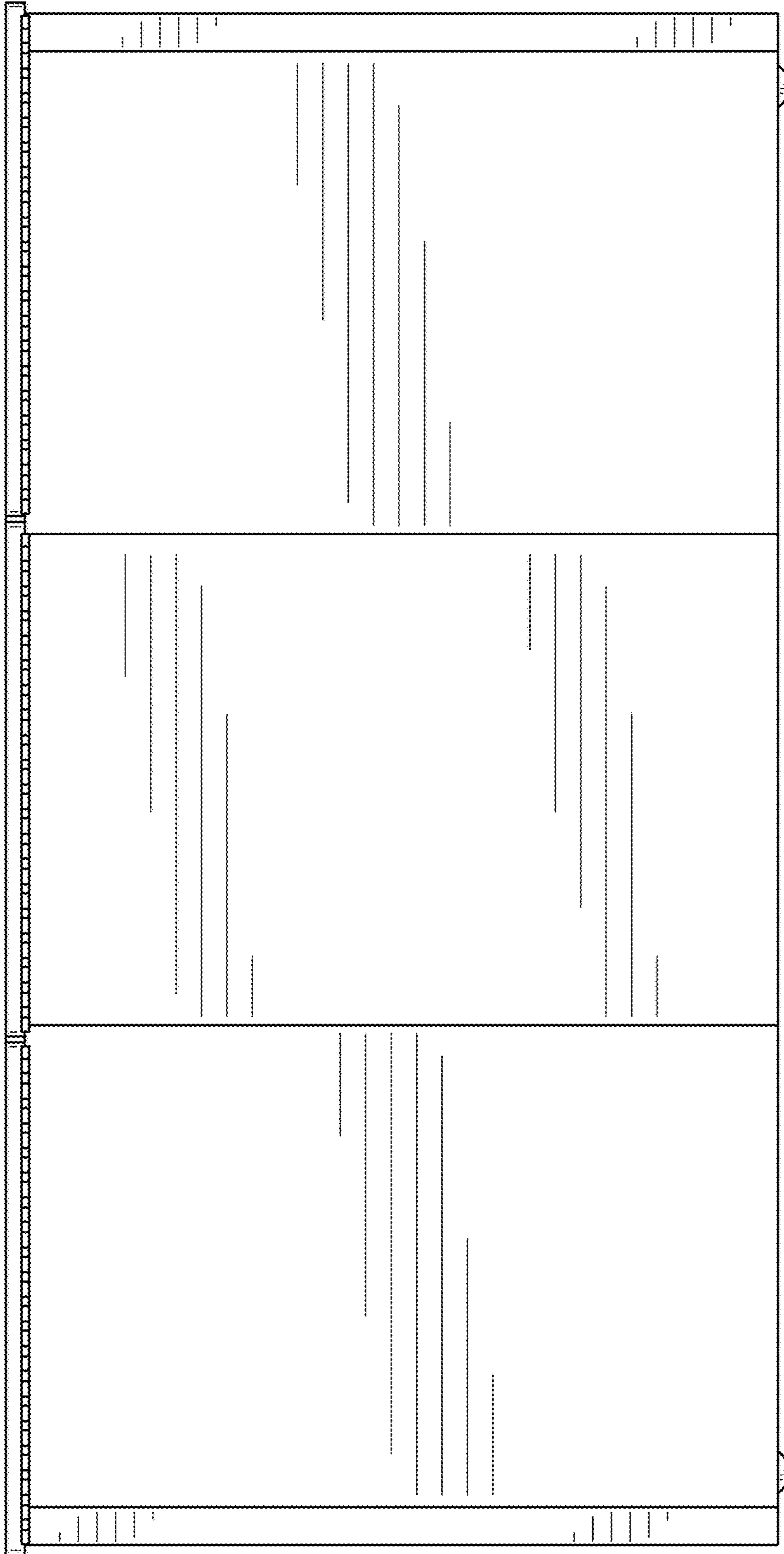

FIG. 6

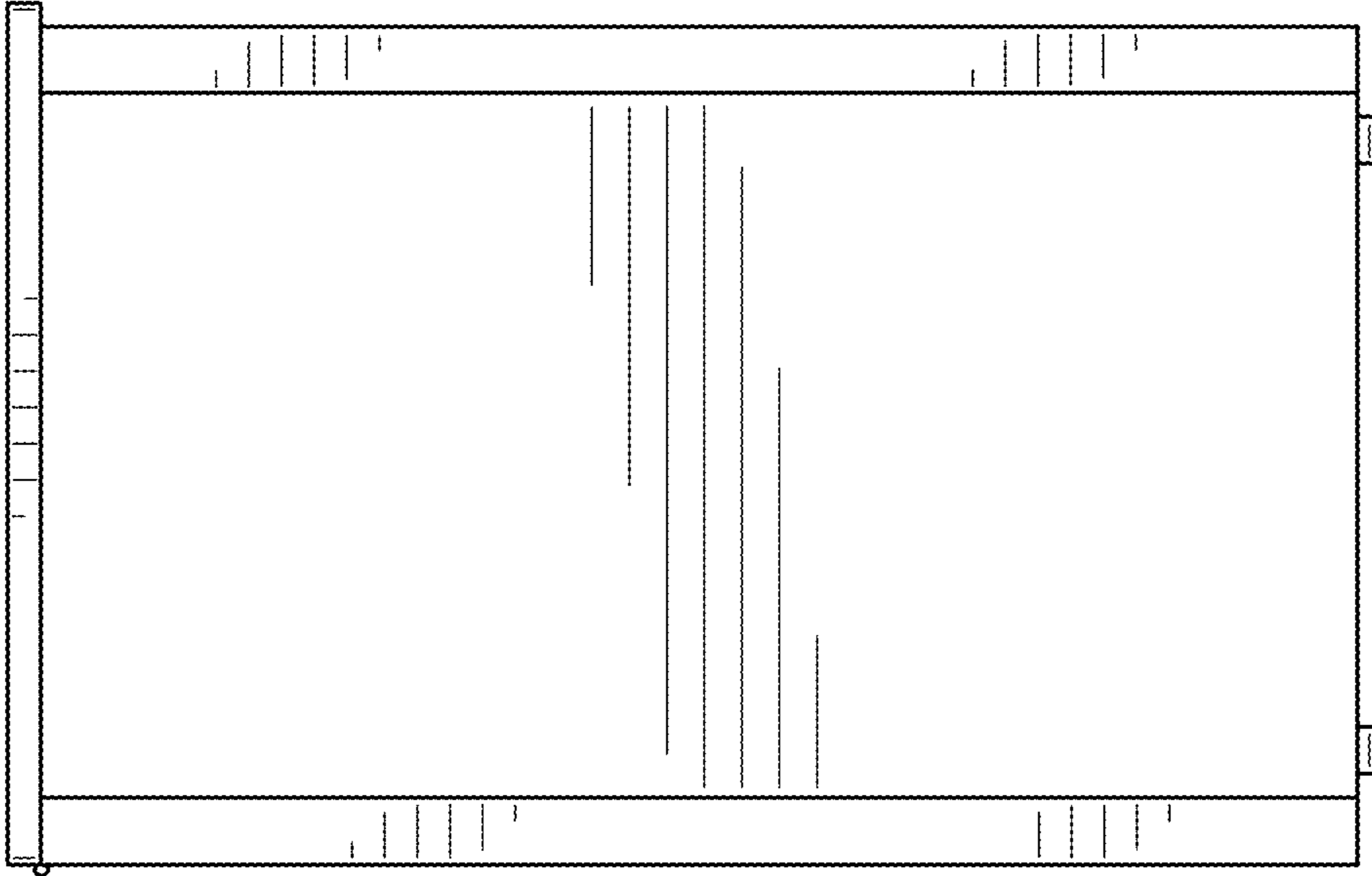

FIG. 8

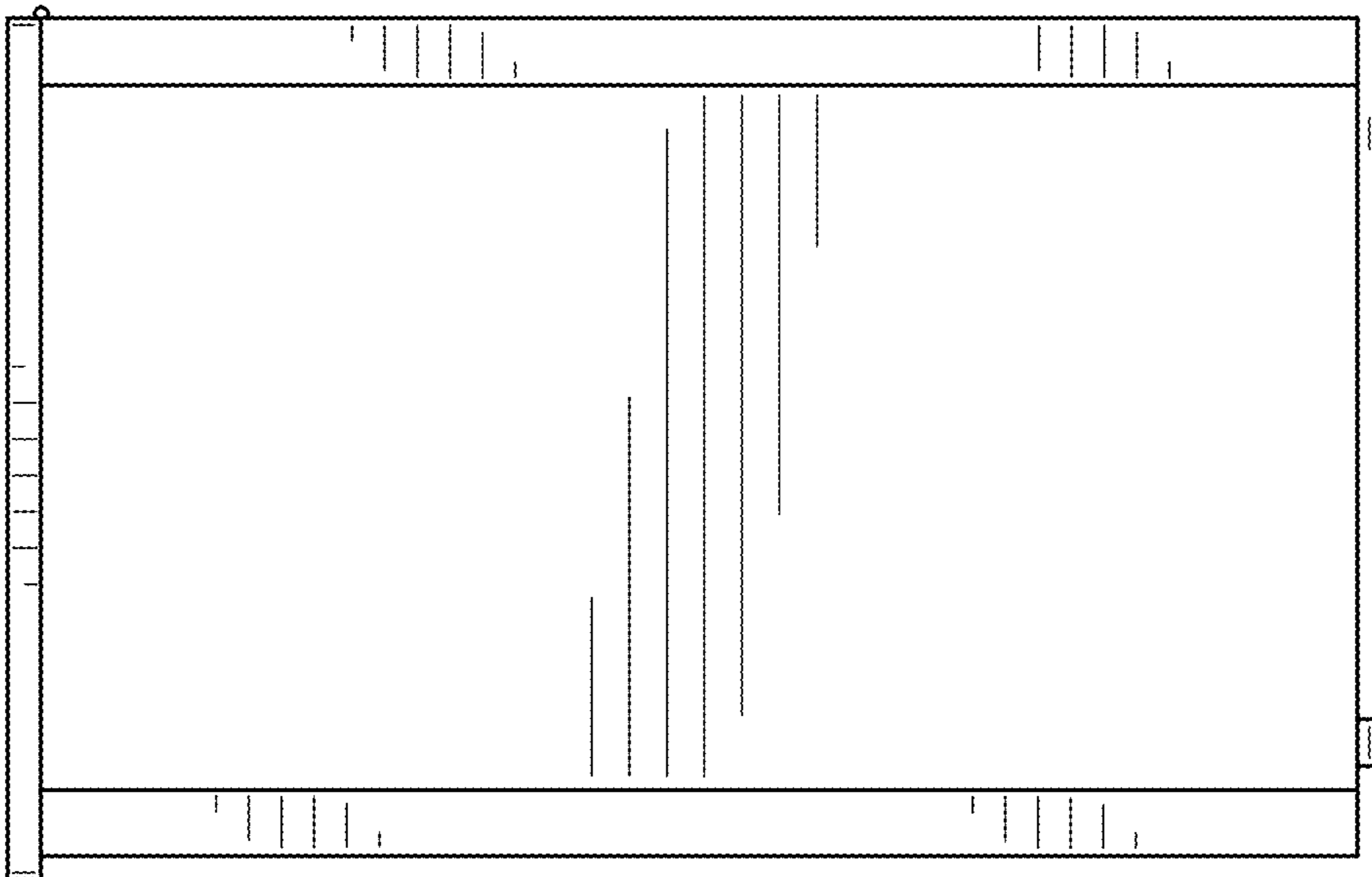

FIG. 7

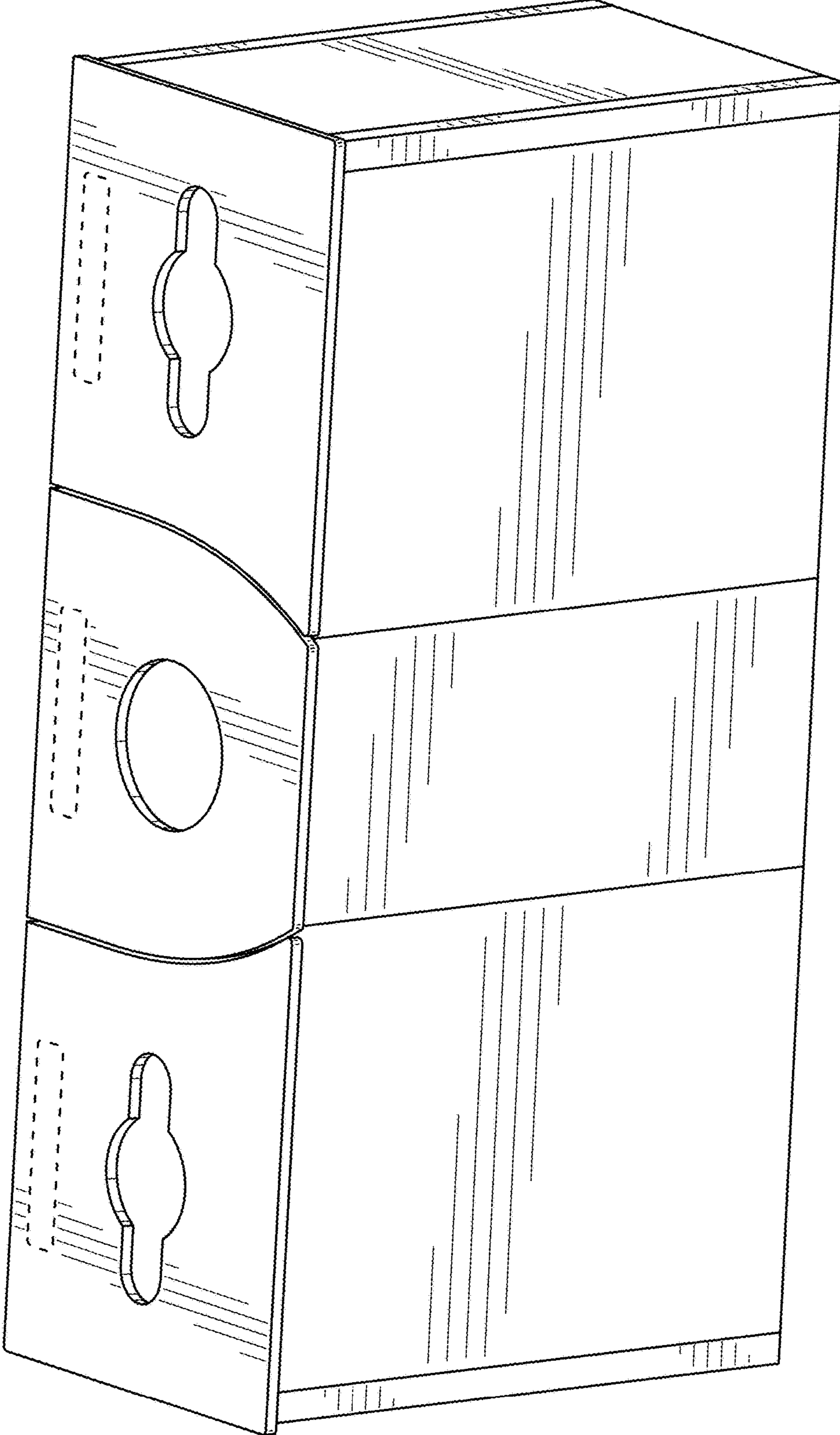

FIG. 9

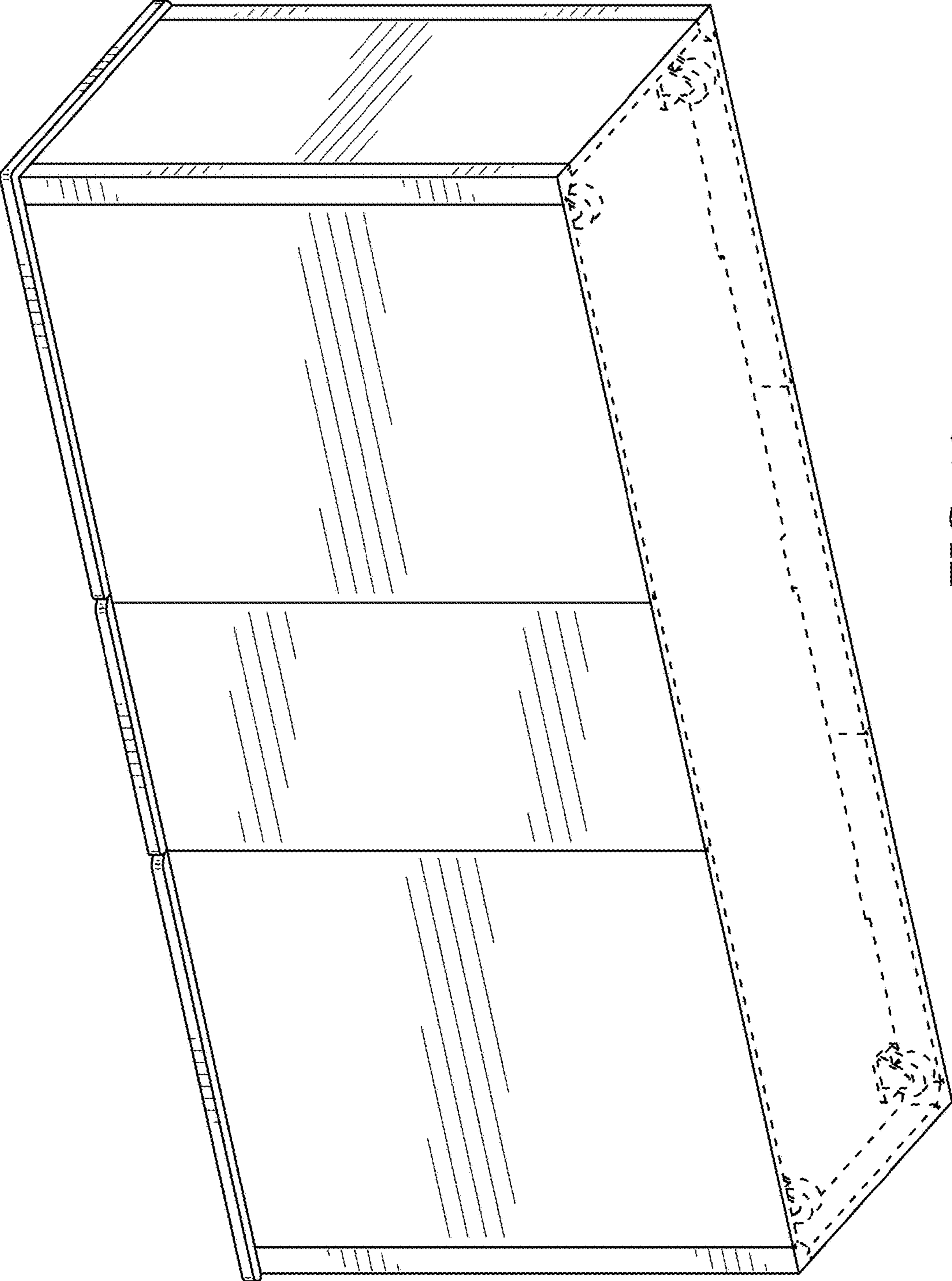

FIG. 10

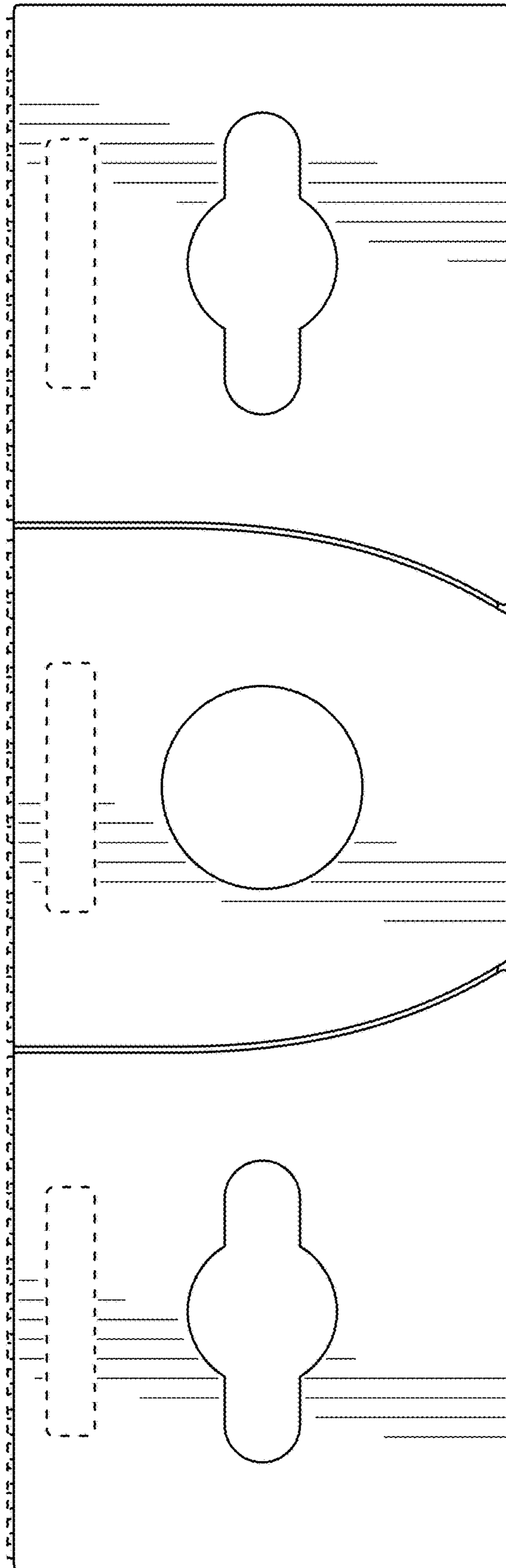

FIG. 11

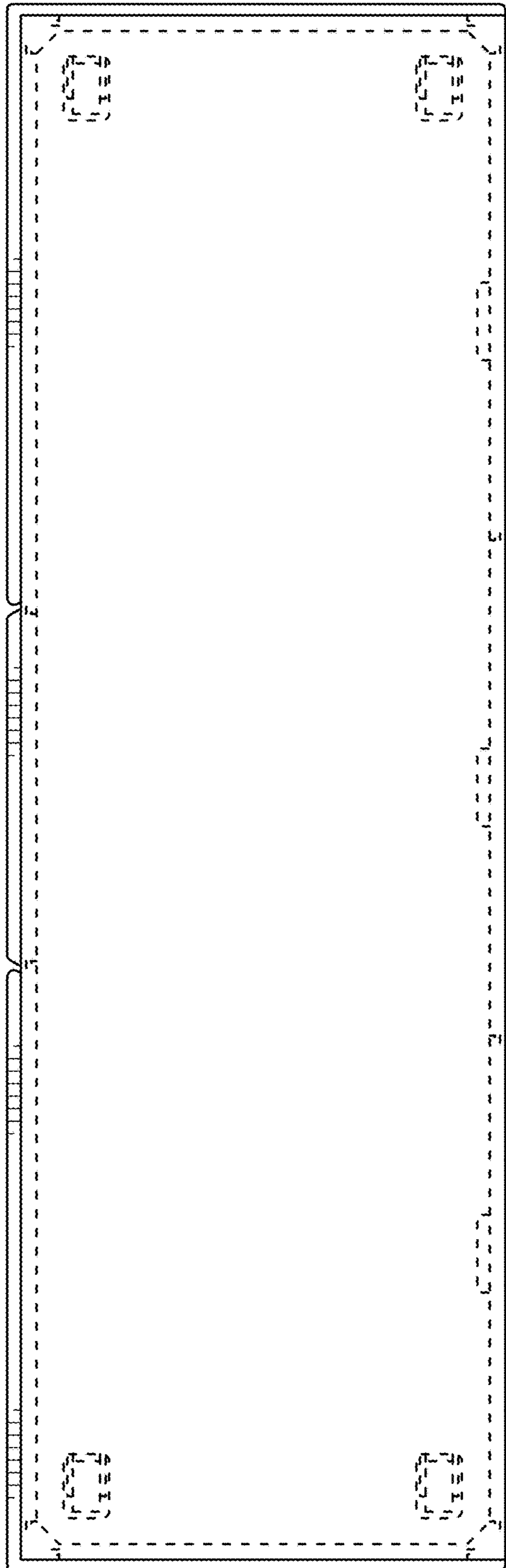

FIG. 12

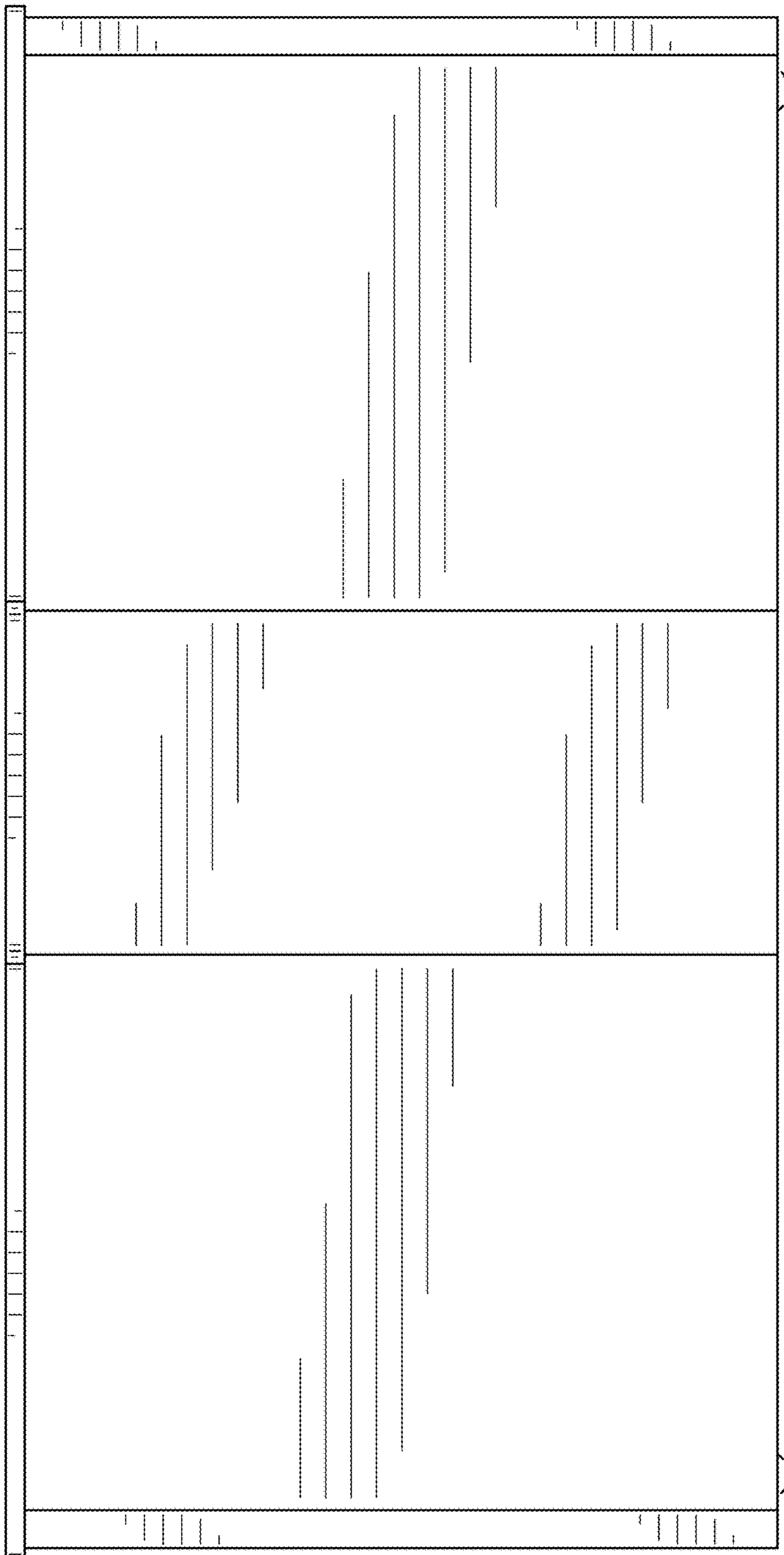

FIG. 13

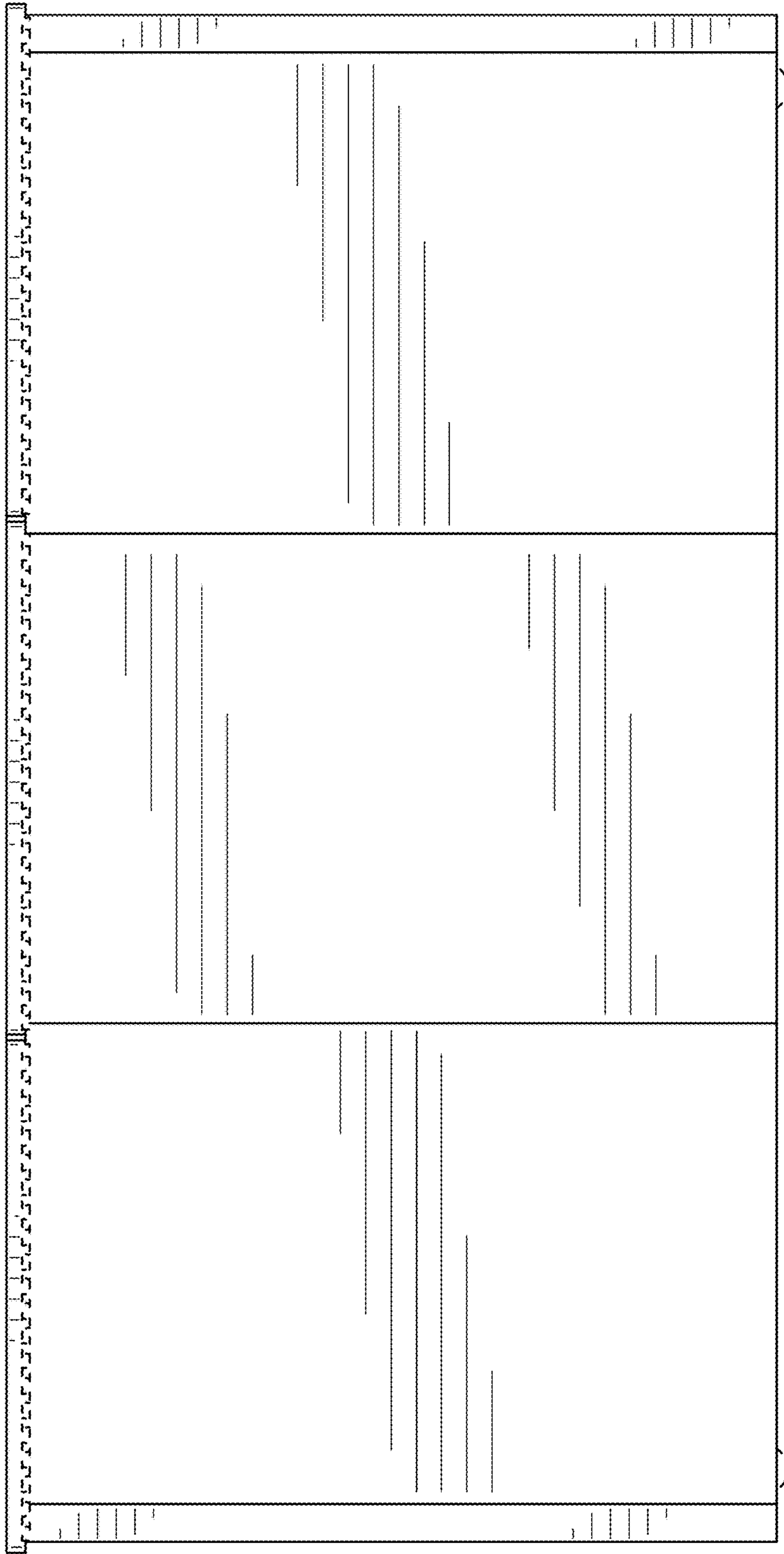

FIG. 14

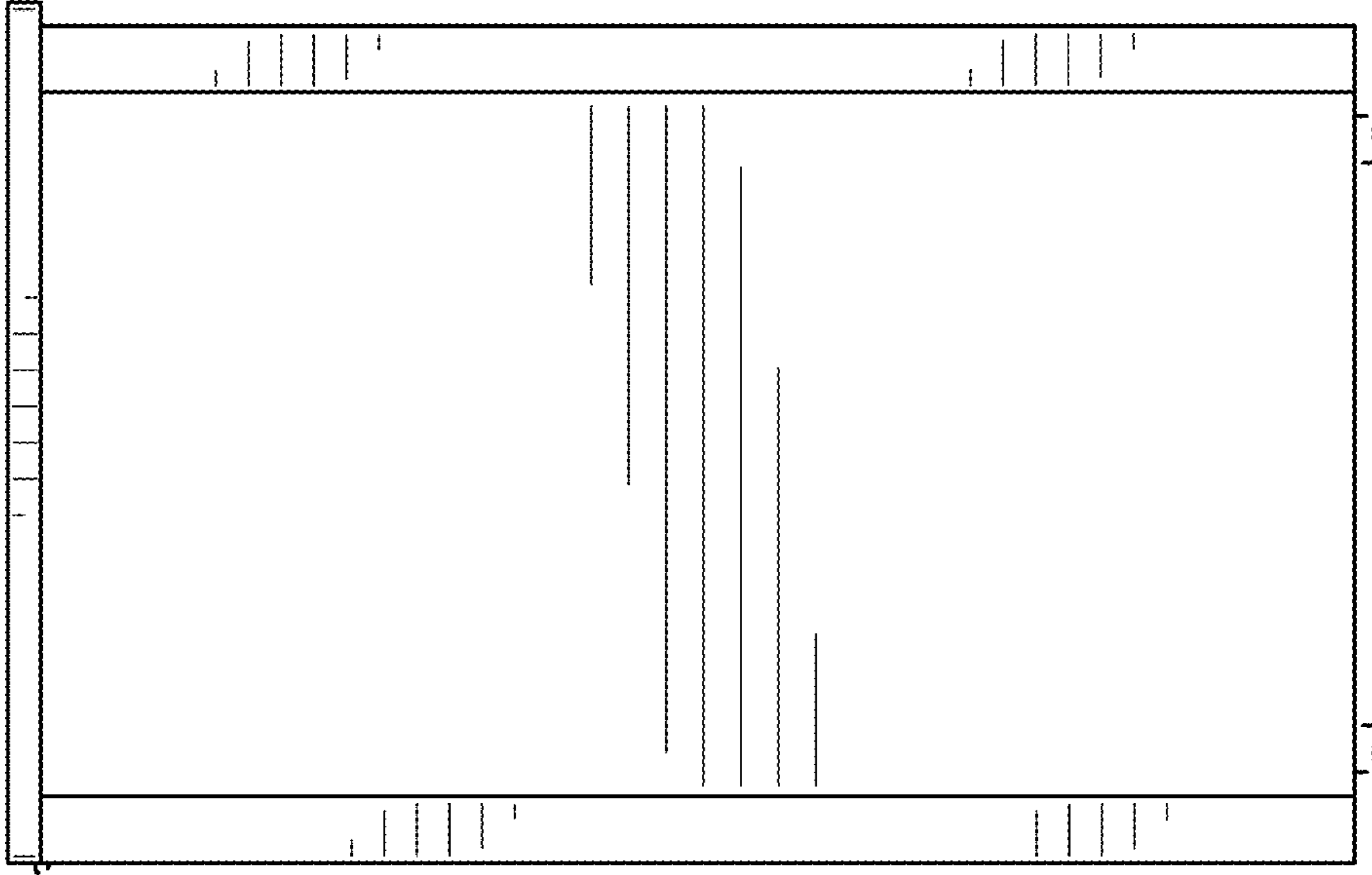

FIG. 16

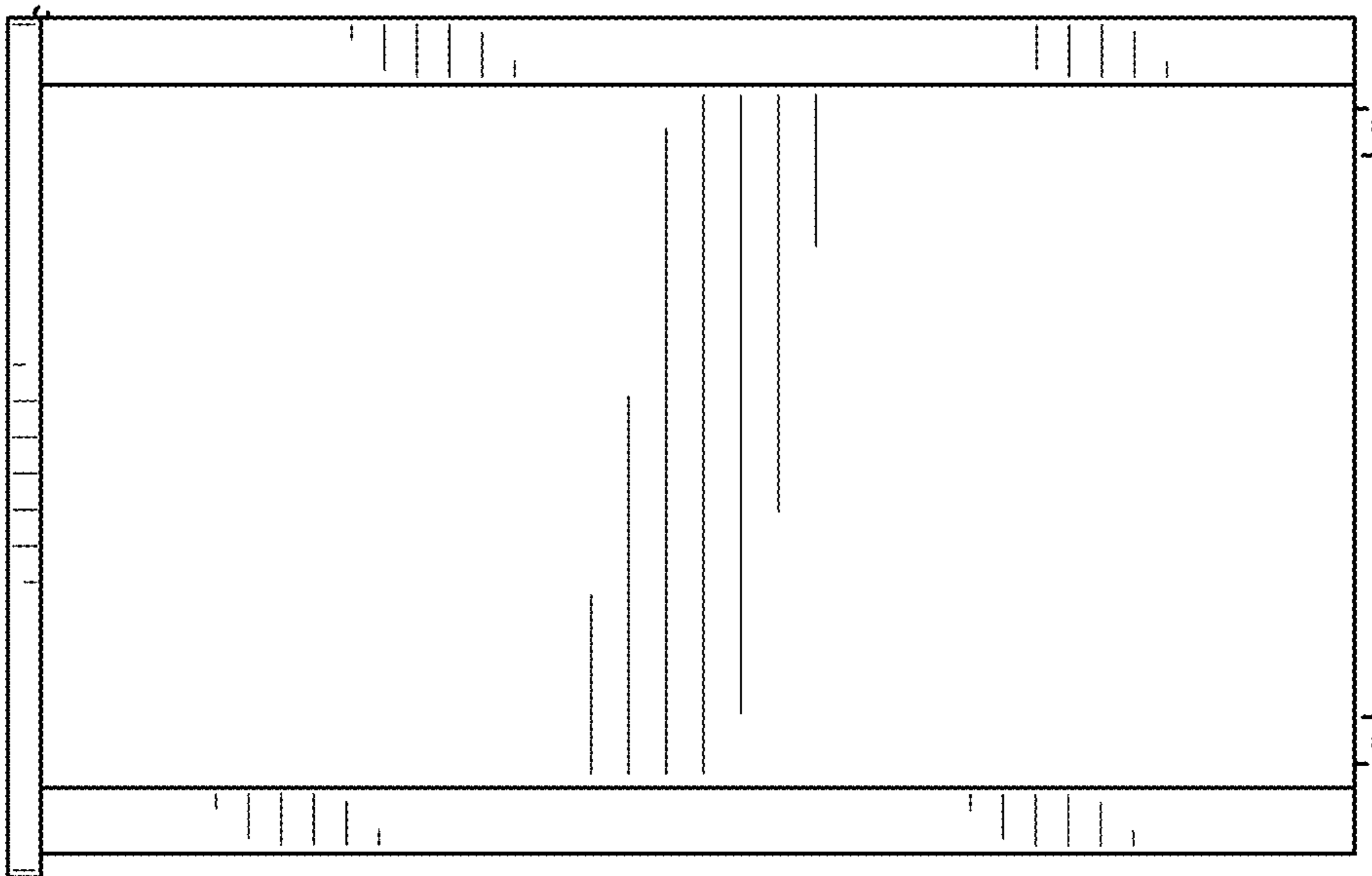

FIG. 15