



US00D779736S

(12) **United States Design Patent** (10) **Patent No.:** **US D779,736 S**
Hansen (45) **Date of Patent:** **** Feb. 21, 2017**

(54) **COSMETIC BOX**
(71) Applicant: **Hal J Hansen**, Toms River, NJ (US)
(72) Inventor: **Hal J Hansen**, Toms River, NJ (US)
(**) Term: **14 Years**
(21) Appl. No.: **29/522,573**
(22) Filed: **Mar. 31, 2015**
(51) **LOC (10) Cl.** **28-03**
(52) **U.S. Cl.**
USPC **D28/83**
(58) **Field of Classification Search**
USPC D28/76-84
(Continued)

(56) **References Cited**
U.S. PATENT DOCUMENTS
D83,872 S 4/1931 McDonell
1,939,013 A 4/1933 Lewis
(Continued)

FOREIGN PATENT DOCUMENTS
GB 1021063 2/1966
GB 1307107 2/1973
(Continued)

OTHER PUBLICATIONS
Aliexpress.com, "False Eyelash Applicator Mascara EyeLash Eye Lash Fake Clip Tool", <http://www.aliexpress.com/item/Hot-Sell-5pcs-lot-False-Eyelash-Applicator-Mascara-EyeLash-Eye-Lash-Fake-Clip-Tool-Free-Shipping/1360080576.html>, accessed Jan. 2, 2014, 9 pages.
(Continued)

Primary Examiner — Jennifer Rivard
(74) *Attorney, Agent, or Firm* — Franklin & Associates International Inc; Matthew F. Lambrinos

(57) **CLAIM**
The ornamental design for a cosmetic box, as shown and described.

DESCRIPTION
FIG. 1 is a perspective from above of a cosmetic box showing my new design according to one embodiment; FIG. 2 is a front view of the cosmetic box of FIG. 1; FIG. 3 is a right side view of the cosmetic box of FIG. 1; FIG. 4 is a left side view of the cosmetic box of FIG. 1; FIG. 5 is a rear view of the cosmetic box of FIG. 1; FIG. 6 is a top view of the cosmetic box of FIG. 1; FIG. 7 is rear perspective from above the cosmetic box of FIG. 1;
FIG. 8 is a perspective view from above of a cosmetic box showing my new design according to another embodiment; FIG. 9 is a front view of the cosmetic box of FIG. 8; FIG. 10 is a right side view of the cosmetic box of FIG. 8; FIG. 11 is a left side view of the cosmetic box of FIG. 8; FIG. 12 is a rear view of the cosmetic box of FIG. 8; FIG. 13 is a top view of the cosmetic box of FIG. 8; and, FIG. 14 is rear perspective from above the cosmetic box of FIG. 8.
The broken lines shown along the rear of the cosmetic box illustrate portions of the cosmetic box and form no part of the claimed design.
The bottom view of the cosmetic box forms not part of the claimed design.
In the embodiment shown in FIGS. 8-14, the cosmetic box is shown with a symbolic break in length. The appearance of any portion of the article between the break lines forms no part of the claimed design.

1 Claim, 8 Drawing Sheets

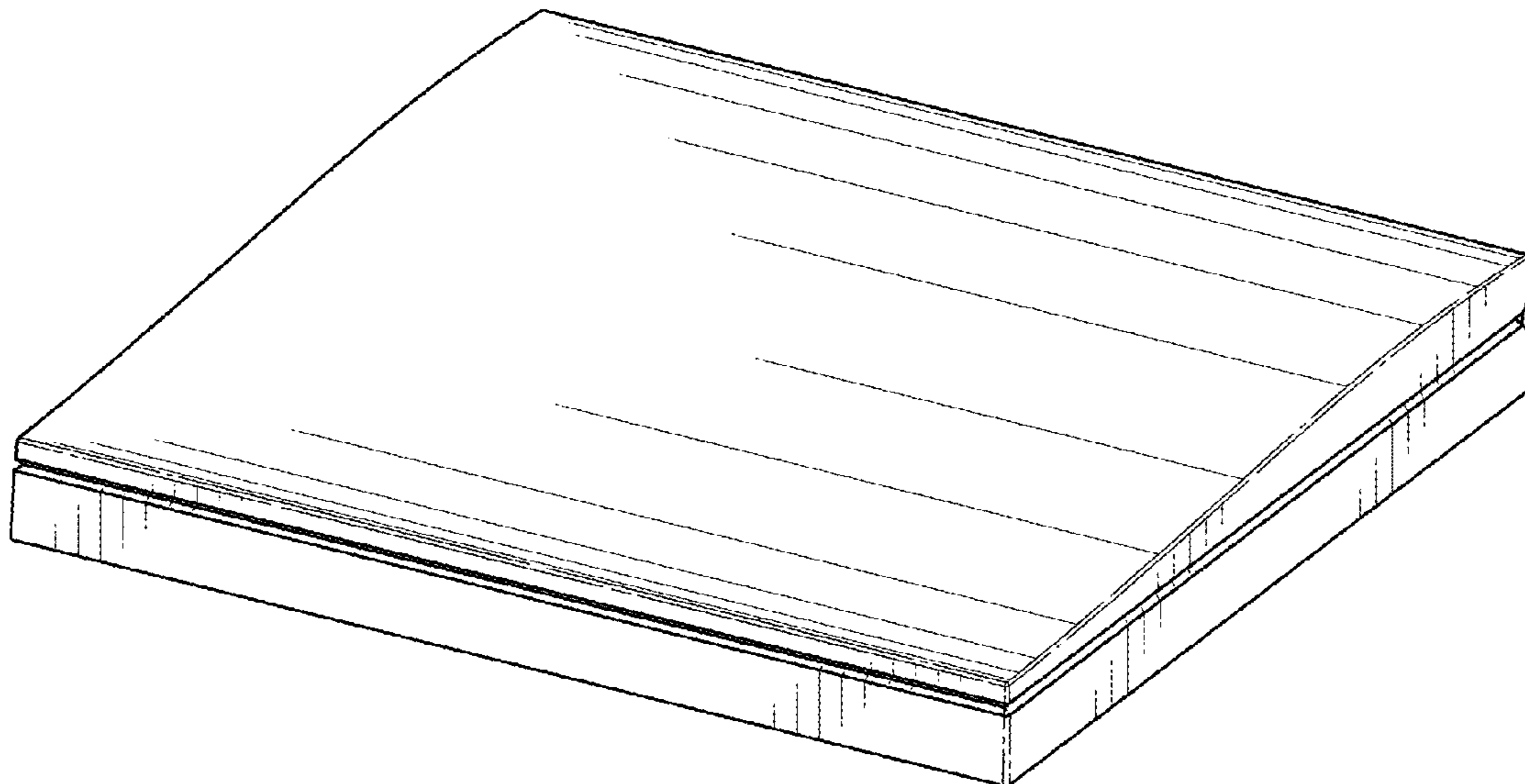

(58) **Field of Classification Search**

CPC A45D 33/00–33/003; A45D 33/006;
 A45D 33/008; A45D 33/02; A45D
 33/025; A45D 33/06–33/10; A45D 33/16;
 A45D 33/18; A45D 33/20; A45D 33/22;
 A45D 33/24; A45D 33/26; A45D 33/28;
 A45D 40/00; A45D 40/22–40/24; A45D
 40/0075

See application file for complete search history.

(56)

References Cited

U.S. PATENT DOCUMENTS

1,960,687	A	5/1934	Wills	
1,666,116	A	4/1938	Bunnell	
D119,329	S	3/1940	Leyne	
D129,526	S	9/1941	Hanisch	
D133,455	S	11/1941	Tuttle	
2,268,082	A	12/1941	Phillips, Sr.	
2,323,595	A	7/1943	Hanisch	
D143,945	S	2/1946	Wolff	
D155,157	S	9/1949	Hickey	
2,760,264	A	8/1956	Javits	
3,016,059	A	1/1962	Hutton	
3,333,593	A	8/1967	McGivern	
3,339,561	A	9/1967	Brickner	
D210,180	S	2/1968	Solomon	
D213,239	S	1/1969	Flewwellin	
3,461,886	A	8/1969	Bau	
D215,985	S	11/1969	Silson	
3,478,754	A	11/1969	Martin, Jr.	
3,511,248	A	5/1970	Panda	
3,516,423	A	6/1970	Seidler	
D218,870	S	9/1970	Aylott	
3,547,135	A	12/1970	Roos	
3,556,113	A	1/1971	Frieder	
D219,854	S	2/1971	Howard	
3,561,454	A	2/1971	O'Connell	
3,590,828	A	7/1971	Prewitt	
D222,518	S	10/1971	Brittain	
3,625,229	A	12/1971	Silson	
3,654,939	A	4/1972	Davidson	
3,670,742	A	6/1972	Weaner	
3,722,519	A	3/1973	Epstein	
D328,504	S	8/1992	Davies	
5,927,295	A	7/1999	Quinones	
D430,955	S	9/2000	Ishida	
D437,086	S	1/2001	Dickert	
D449,408	S	10/2001	McMillan	
D455,521	S	4/2002	Park	
D503,494	S	3/2005	Yamashita	
D559,449	S	1/2008	Lin	
D573,307	S	7/2008	Cho	
D576,352	S	9/2008	Brestoni	
D581,096	S	11/2008	Zhang	
D587,899	S	3/2009	Oksanen	
D600,857	S *	9/2009	Maddy D28/83	
D609,403	S	2/2010	Cho	
D611,657	S *	3/2010	Maddy D28/83	
D629,201	S *	12/2010	Demarco D28/83	
D630,794	S	1/2011	Cohen Harel	
8,015,980	B2	9/2011	Rabe	
8,196,591	B2	6/2012	Lee et al.	

D674,182	S	1/2013	Copeland	
D677,004	S	2/2013	Cole	
8,424,542	B1	4/2013	Han	
D721,856	S *	1/2015	Villarreal D28/83	
9,215,901	B1	12/2015	Schroeder	
D757,359	S	5/2016	Van Keppel	
2002/0189628	A1	12/2002	Iosilevich	
2005/0166939	A1	8/2005	Stroud	
2009/0223534	A1	9/2009	Green	
2012/0136748	A1 *	5/2012	Shasteen A45D 33/18 705/26.5	
2013/0042884	A1	2/2013	Wilkinson	
2013/0160783	A1	6/2013	Ahn et al.	
2015/0201692	A1	7/2015	Hansen	

FOREIGN PATENT DOCUMENTS

JP	2011005013	1/2011
JP	2012072510	4/2012
WO	2015109266 A1	7/2015

OTHER PUBLICATIONS

Beautyjunkiesunite.com, "Make Applying False Lashes Easy with the Ardell Pro Lash Applicator", <http://www.beautyjunkiesunite.com/WP/2013/11/11/make-applying-false-lashes-easy-with-the-ardell-pro-lash-applicator/>, Nov. 11, 2013, 7 pages.

Sephora.com, "Bulls Eye Lash Applicator", <http://www.sephora.com/bulls-eye-lash-applicator-P374552>, accessed Jan. 2, 2014, 4 pages.

"Mini Portable cosmetic Eyelash Curl Curling Clamp", www.paywithless.com/makeup/4166-1-pcs-mini-portable-cosmetic-eyelash-curl-curling-clamp-for-woman-color-random.html, accessed Jan. 3, 2014, 31 pages.

International Search Report issued on May 11, 2015 for PCT Application PCT/US2015/011873.

U.S. Appl. No. 29/522,564, filed Mar. 31, 2015, entitled False Eyelash Applicator by Hal J Hansen, 25 pages.

U.S. Appl. No. 29/522,565, filed Mar. 31, 2015, entitled False Eyelash Support by Hal J Hansen, 14 pages.

U.S. Appl. No. 29/522,569, filed Mar. 31, 2015, entitled False Eyelash Support by Hal J Hansen, 14 pages.

U.S. Appl. No. 29/522,575, filed Mar. 31, 2015, entitled False Eyelash Support Holder by Hal J Hansen, 15 pages.

U.S. Appl. No. 29/522,579, filed Mar. 31, 2015, entitled False Eyelash Support Inverter by Hal J Hansen, 18 pages.

U.S. Appl. No. 29/522,582, filed Mar. 31, 2015, entitled Cosmetic Box by Hal J Hansen, 26 pages.

U.S. Appl. No. 29/571,700, filed Jul. 20, 2016, entitled False Eyelash Support by Hal Hansen, 17 pages.

Restriction Requirement issued on Jun. 16, 2016 for Design U.S. Appl. No. 29/522,564.

Restriction Requirement issued on Jun. 16, 2016 for Design U.S. Appl. No. 29/522,579.

U.S. Appl. No. 15/215,571, filed Jul. 20, 2016, entitled False Eyelash Support by Hal Hansen, 97 pages.

Restriction Requirement in Design U.S. Appl. No. 14/599,496 dated May 31, 2016.

Restriction Requirement in Design U.S. Appl. No. 29/522,582 dated Jun. 22, 2016.

* cited by examiner

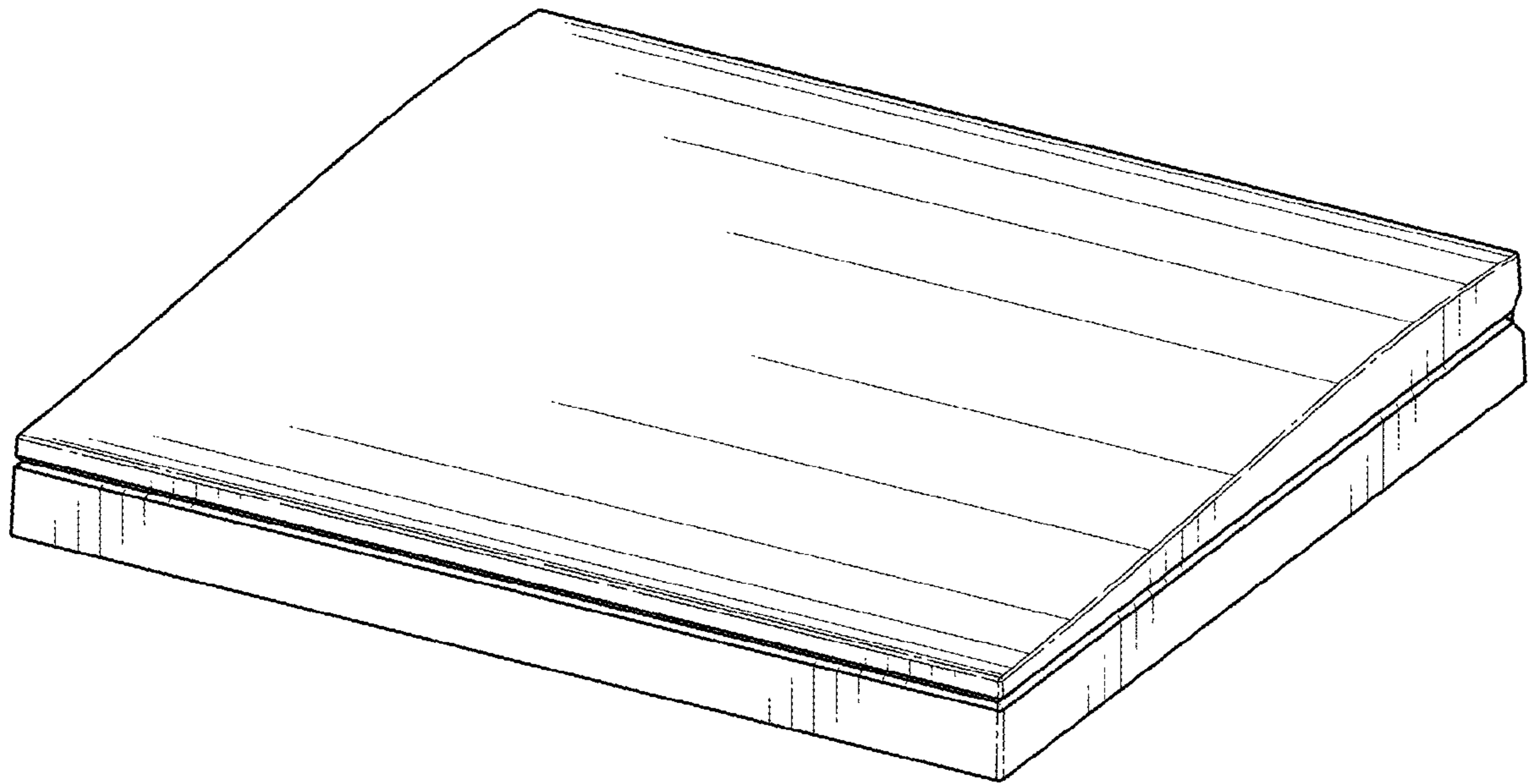

FIG. 1

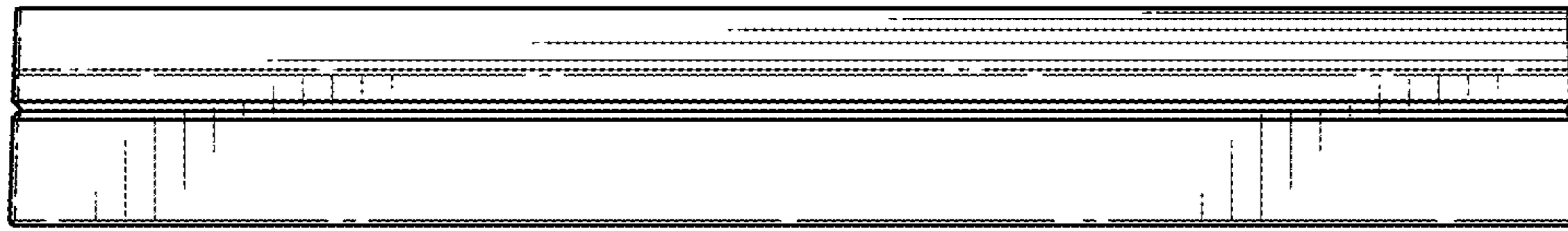

FIG. 2

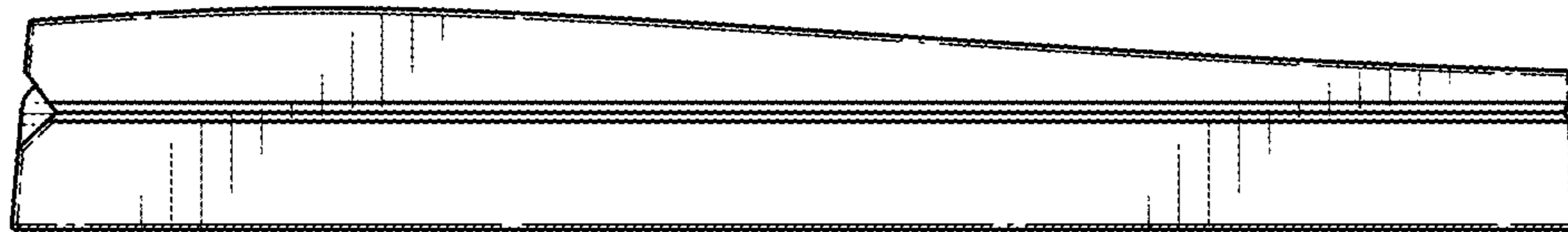

FIG. 3

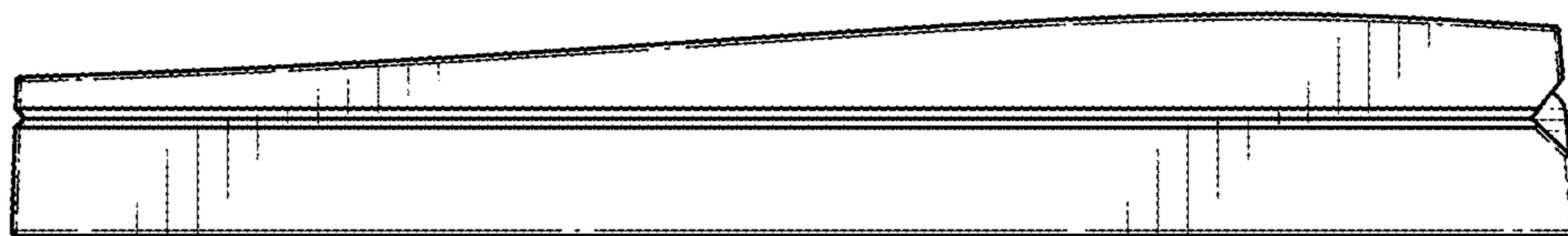

FIG. 4

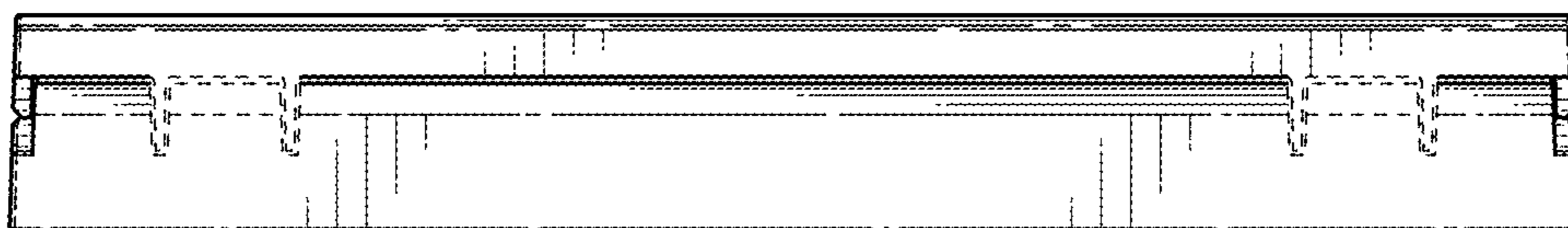

FIG. 5

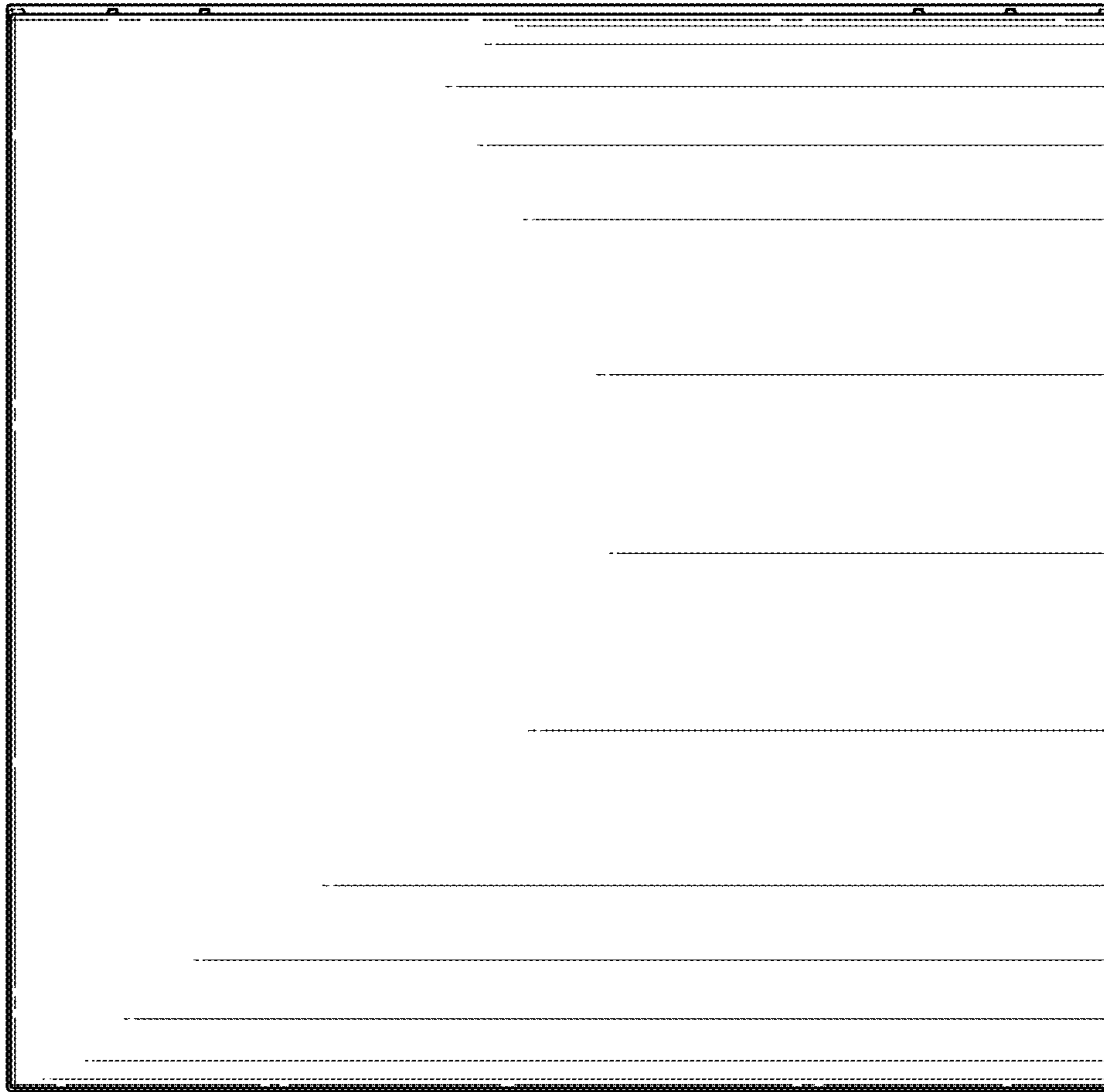

FIG. 6

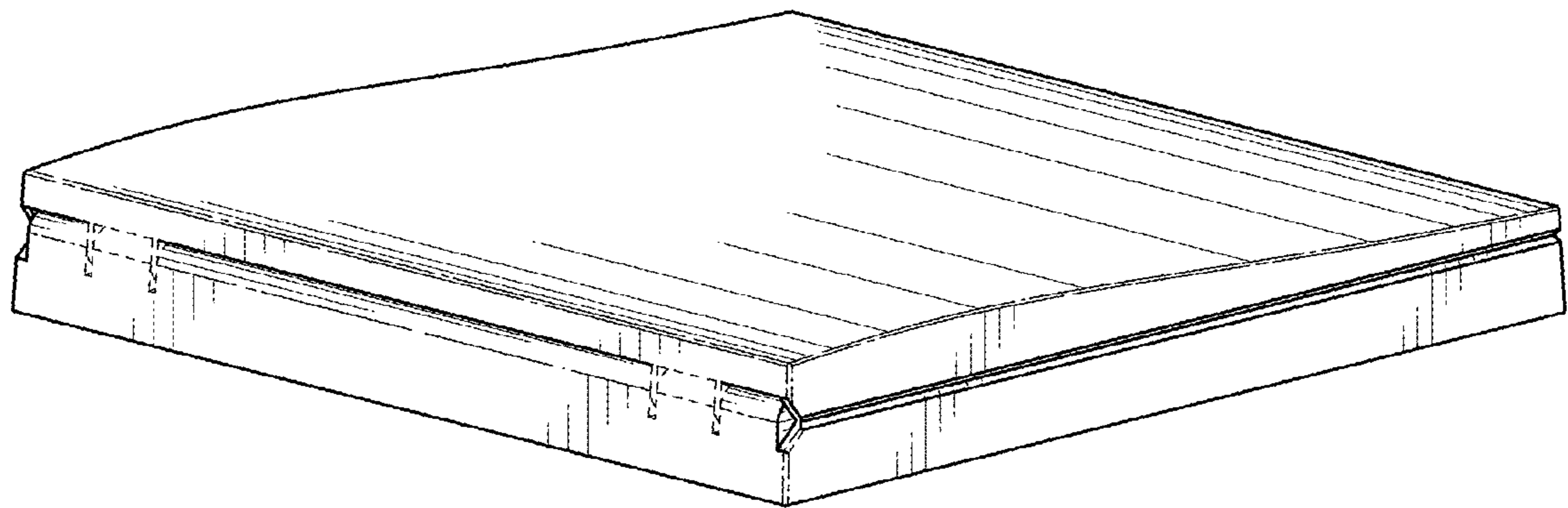

FIG. 7

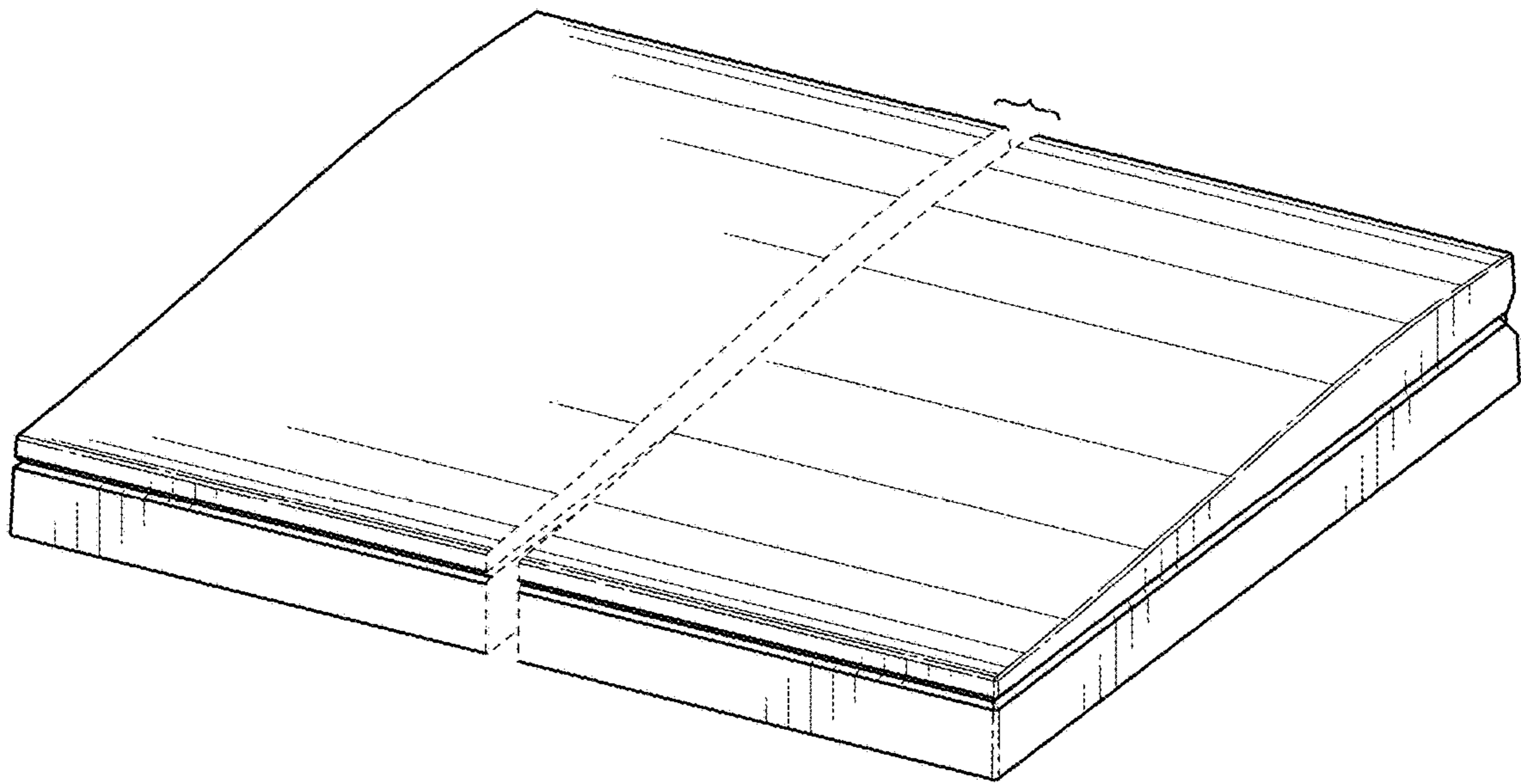

FIG. 8

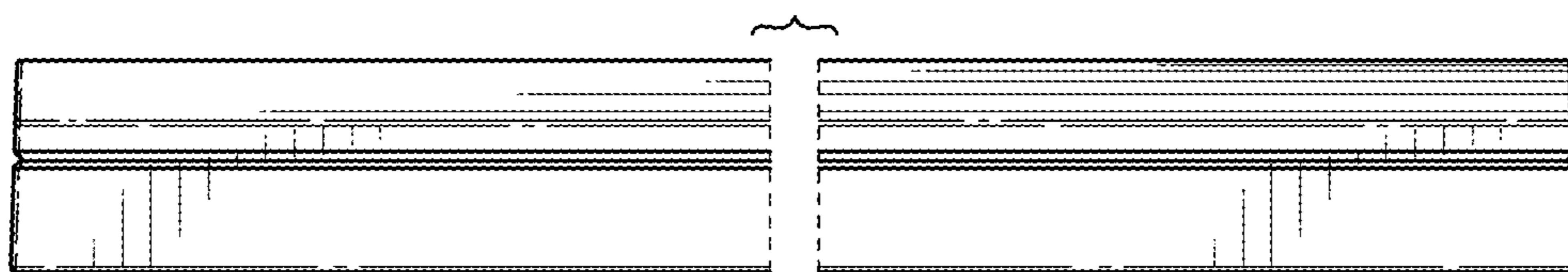

FIG. 9

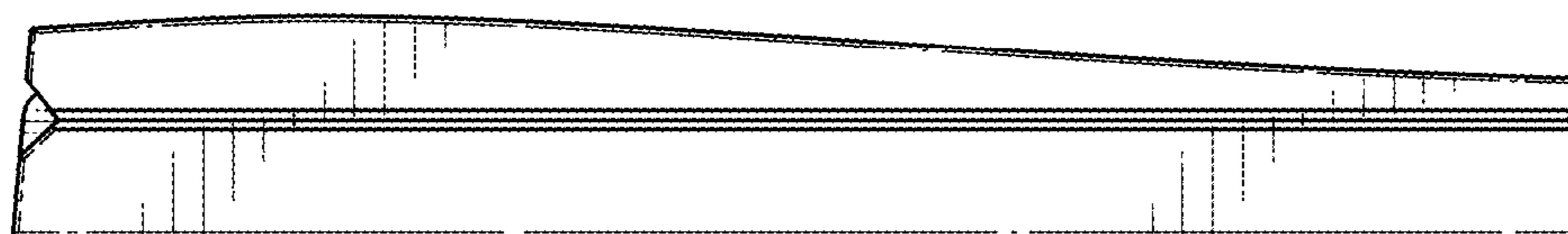

FIG. 10

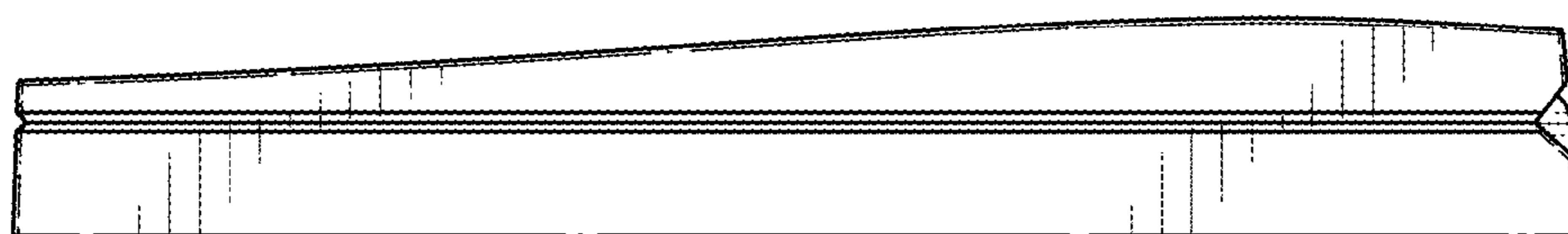

FIG. 11

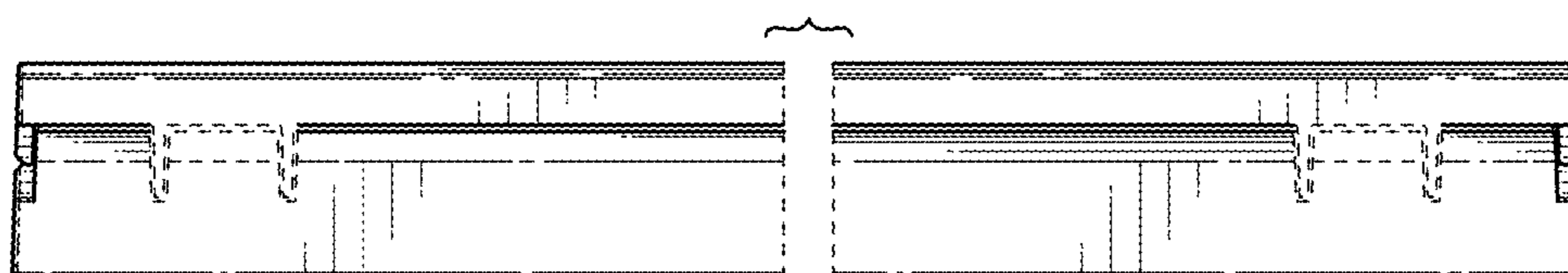

FIG. 12

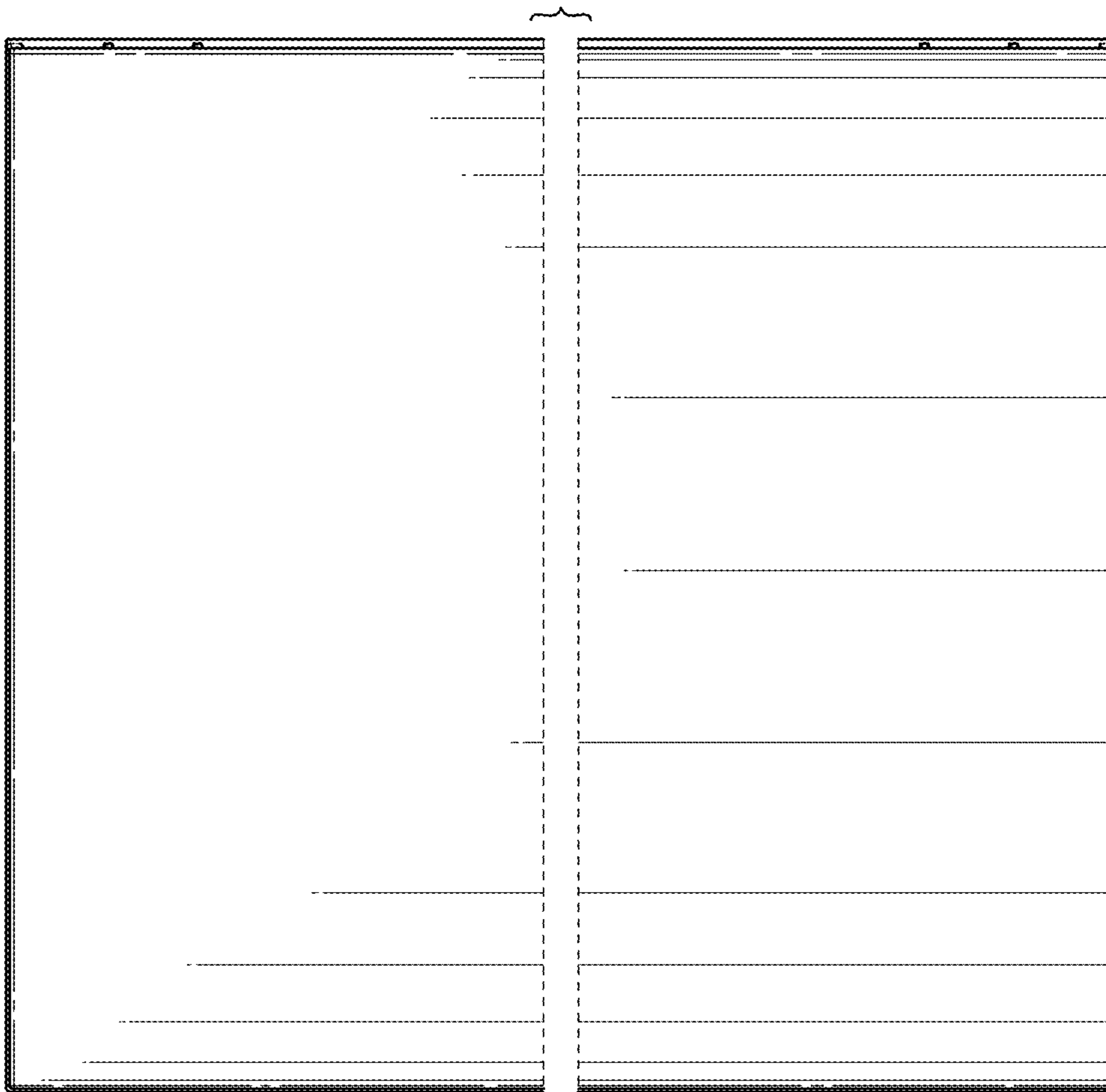

FIG. 13

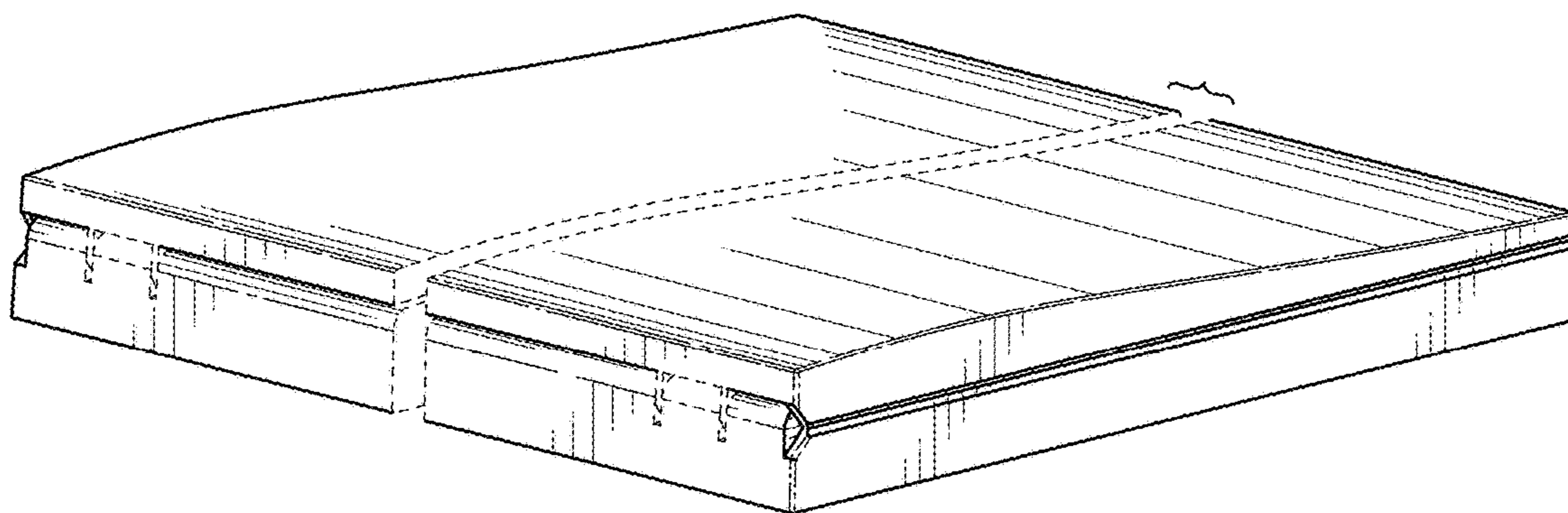

FIG. 14