



US00D779708S

(12) **United States Design Patent**
Anderson et al.

(10) **Patent No.:** **US D779,708 S**
(45) **Date of Patent:** **** Feb. 21, 2017**

(54) **LIGHTING FIXTURE**

DESCRIPTION

- (71) Applicant: **APPARATUS LLC**, New York, NY (US)
- (72) Inventors: **Jeremy R. Anderson**, Rhinebeck, NY (US); **Gabriel Hendifar**, Rhinebeck, NY (US)
- (73) Assignee: **APPARATUS LLC**, New York, NY (US)
- (**) Term: **15 Years**
- (21) Appl. No.: **29/569,675**
- (22) Filed: **Jun. 29, 2016**

Related U.S. Application Data

- (63) Continuation of application No. 29/527,197, filed on May 16, 2015, now Pat. No. Des. 767,197.
- (51) **LOC (10) Cl.** **26-99**
- (52) **U.S. Cl.**
USPC **D26/118**
- (58) **Field of Classification Search**
USPC D26/1, 24, 72, 81, 88, 118, 128, 138
(Continued)

(56) **References Cited**

U.S. PATENT DOCUMENTS

- 1,763,963 A * 6/1930 Guth F21V 5/00
362/312
- 1,866,750 A * 7/1932 Brownell F21L 14/00
362/296.08

(Continued)

Primary Examiner — Brian N Vinson

(74) *Attorney, Agent, or Firm* — Gottlieb, Rackman & Reisman, P.C.

(57) **CLAIM**

We claim the ornamental design for a lighting fixture, as shown and described.

FIG. 1 is a left elevation view showing a first embodiment of my new design of a lighting fixture;

FIG. 2 is a right elevation view of the lighting fixture of the first embodiment;

FIG. 3 is a front elevation view of the lighting fixture of the first embodiment;

FIG. 4 is a rear elevation view of the lighting fixture of the first embodiment;

FIG. 5 is a top plan view of the lighting fixture of the first embodiment;

FIG. 6 is a bottom view of the lighting fixture of the first embodiment;

FIG. 7 is a perspective view of the lighting fixture of the first embodiment;

FIG. 8 is a left elevation view showing a second embodiment of my new design of a lighting fixture;

FIG. 9 is a light elevation view of the lighting fixture of the second embodiment;

FIG. 10 is a front elevation view of the lighting fixture of the second embodiment;

FIG. 11 is a rear elevation view of the lighting fixture of the second embodiment;

FIG. 12 is a top plan view of the lighting fixture of the second embodiment;

FIG. 13 is a bottom view of the lighting fixture of the second embodiment;

FIG. 14 is a perspective view of the lighting fixture of the second embodiment;

FIG. 15 is a left elevation view showing a third embodiment of my new design of a lighting fixture;

FIG. 16 is a right elevation view of the lighting fixture of the third embodiment;

FIG. 17 is a front elevation view of the lighting fixture of the third embodiment;

FIG. 18 is a rear elevation view of the lighting fixture of the third embodiment;

FIG. 19 is a top plan view of the lighting fixture of the third embodiment;

FIG. 20 is a bottom view of the lighting fixture of the third embodiment; and,

FIG. 21 is a perspective view of the lighting fixture of the third embodiment.

(Continued)

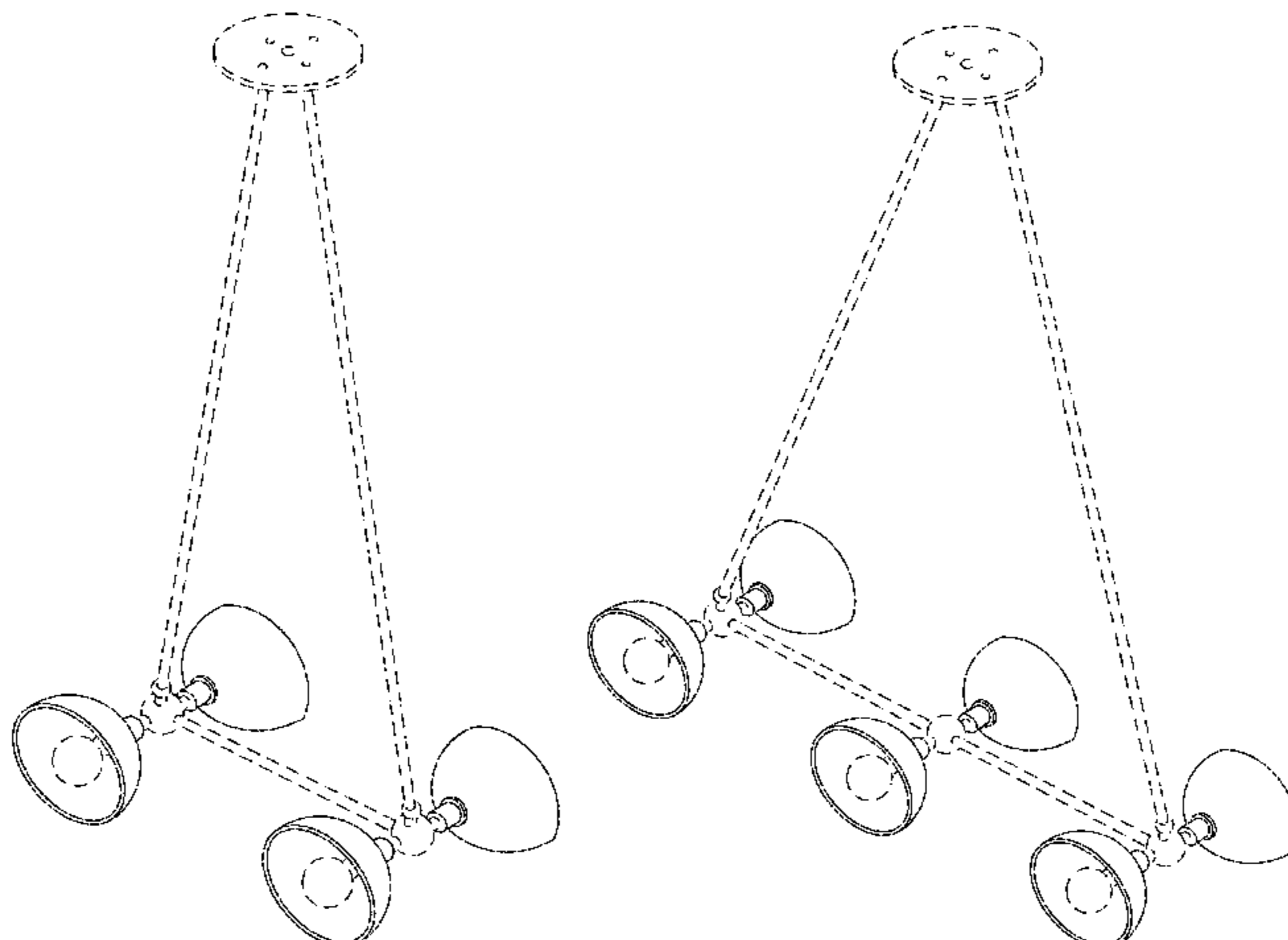

The broken lines depict unclaimed environment. The broken lines form no part of the claimed design.

1 Claim, 21 Drawing Sheets

(58) Field of Classification Search

CPC F21L 14/00; F21V 5/00; F21V 1/00;
F21V 3/00; F21V 7/045; F21V
21/084; F21S 8/00; F21S 8/036; F21S
8/043

See application file for complete search history.

(56) References Cited

U.S. PATENT DOCUMENTS

D200,590	S	*	3/1965	Steenhoven	D26/24
D422,743	S	*	4/2000	Johnson	D26/128
D448,108	S	*	9/2001	Hoffbauer	D26/128
D503,819	S	*	4/2005	Pickett	D26/118
D520,668	S	*	5/2006	Brunner	D26/88
D567,433	S	*	4/2008	Gordin	D26/128
D575,902	S	*	8/2008	Ricereto	D26/138
D576,761	S	*	9/2008	Porter	D26/128
D616,142	S	*	5/2010	Bagnall	D26/128
D741,533	S	*	10/2015	Yeh	D26/72

* cited by examiner

FIG. 1

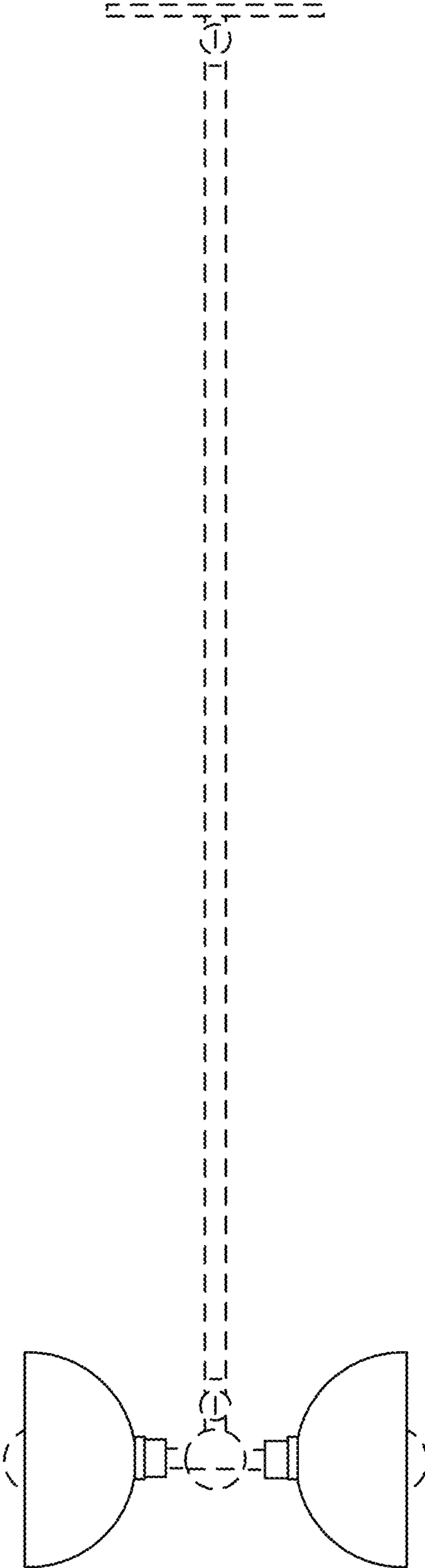
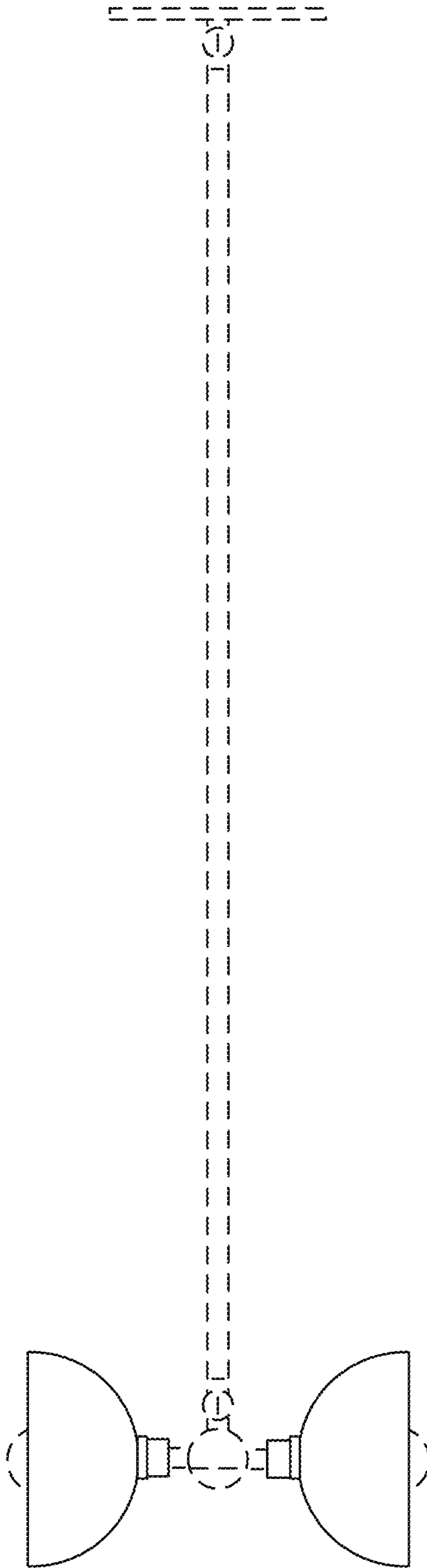

FIG. 2



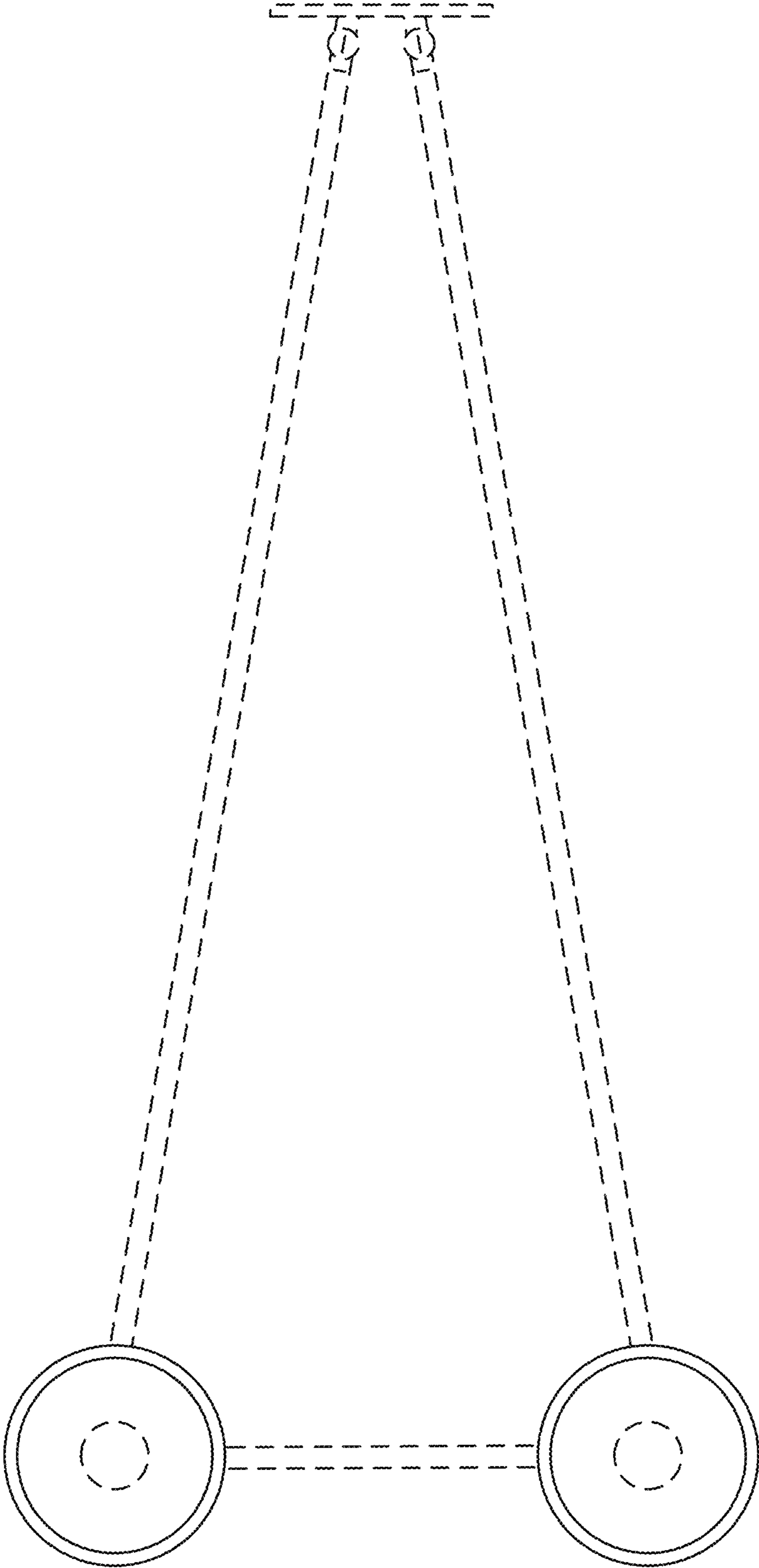
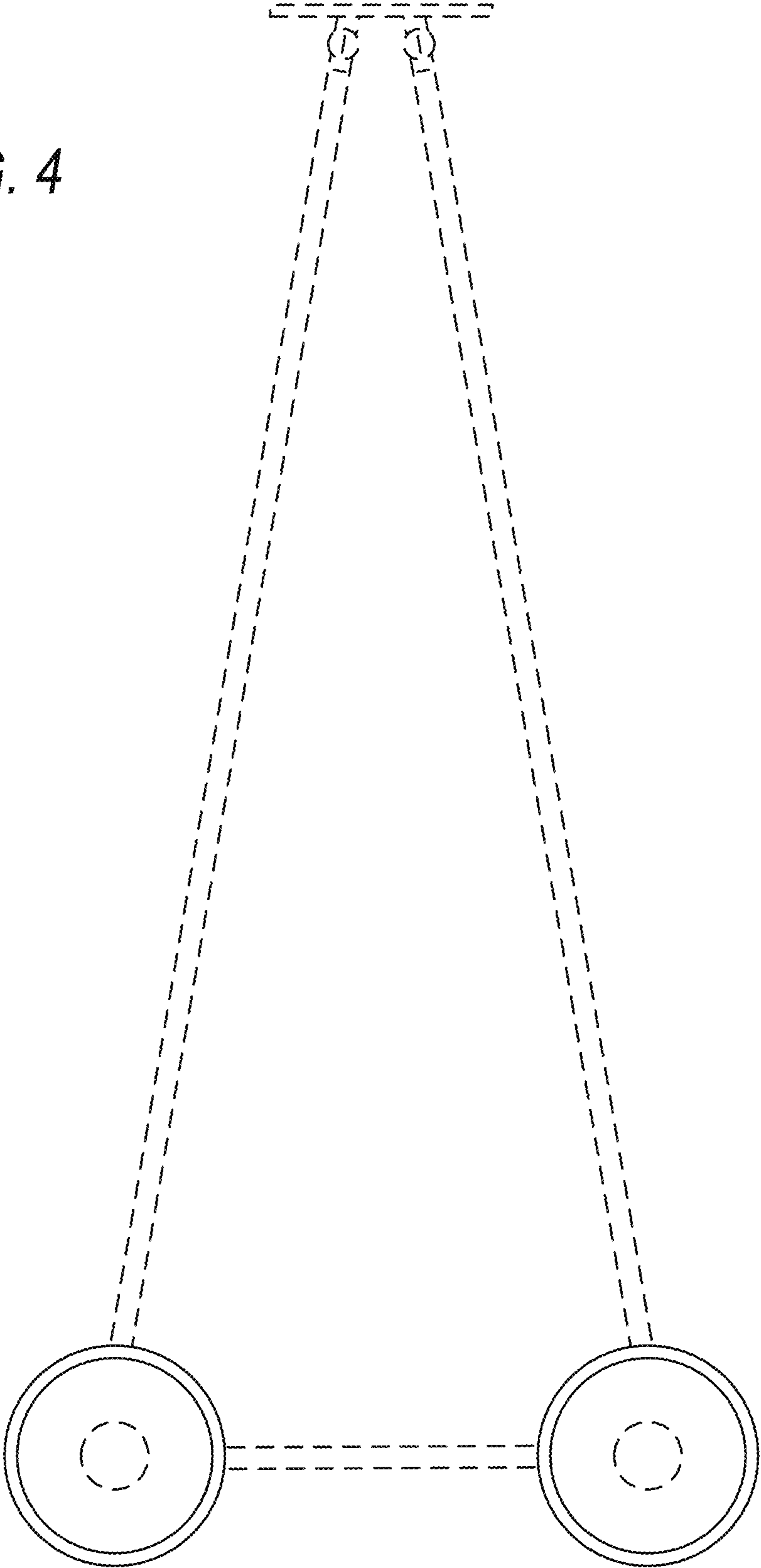

FIG. 3

FIG. 4



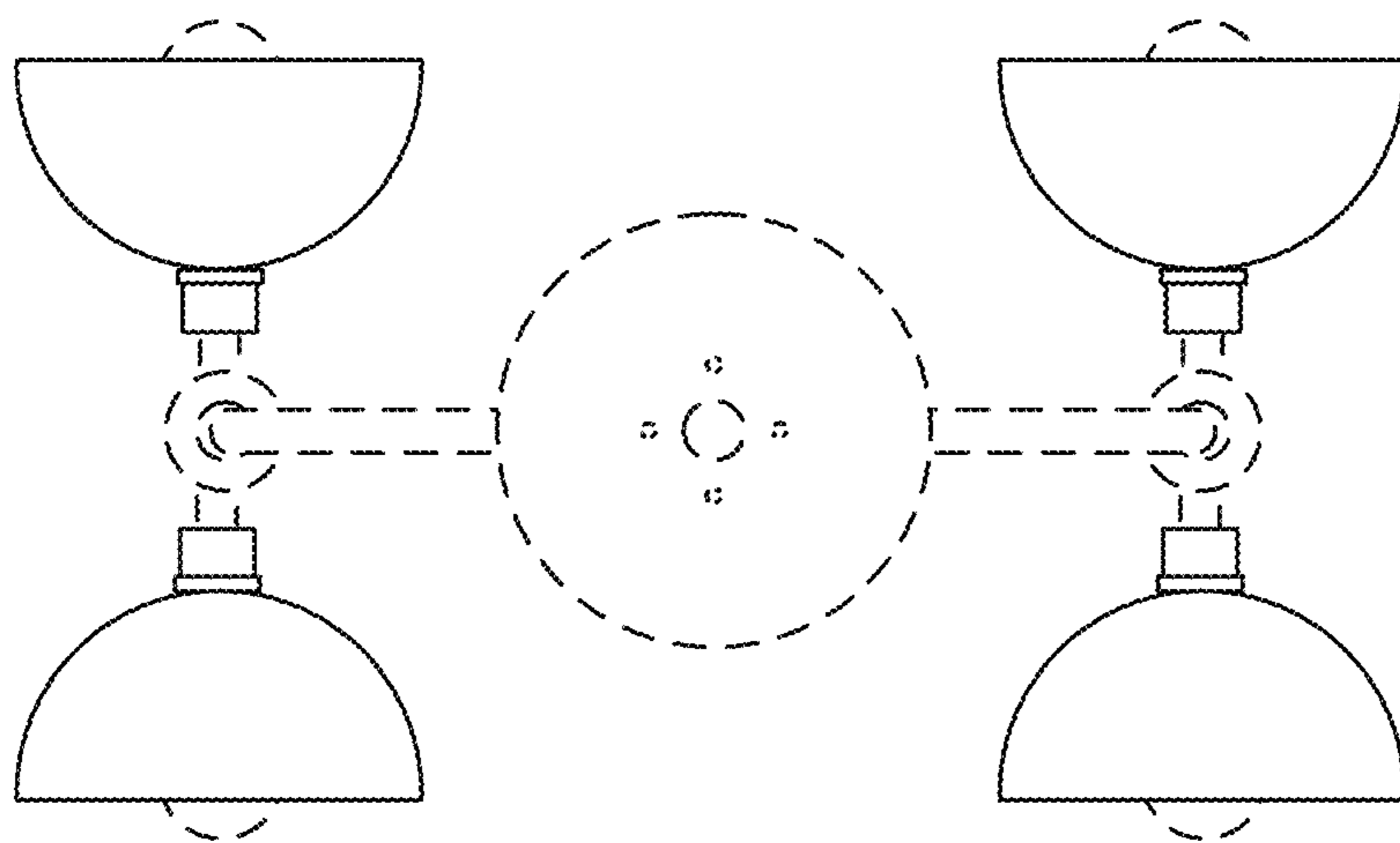

FIG. 5

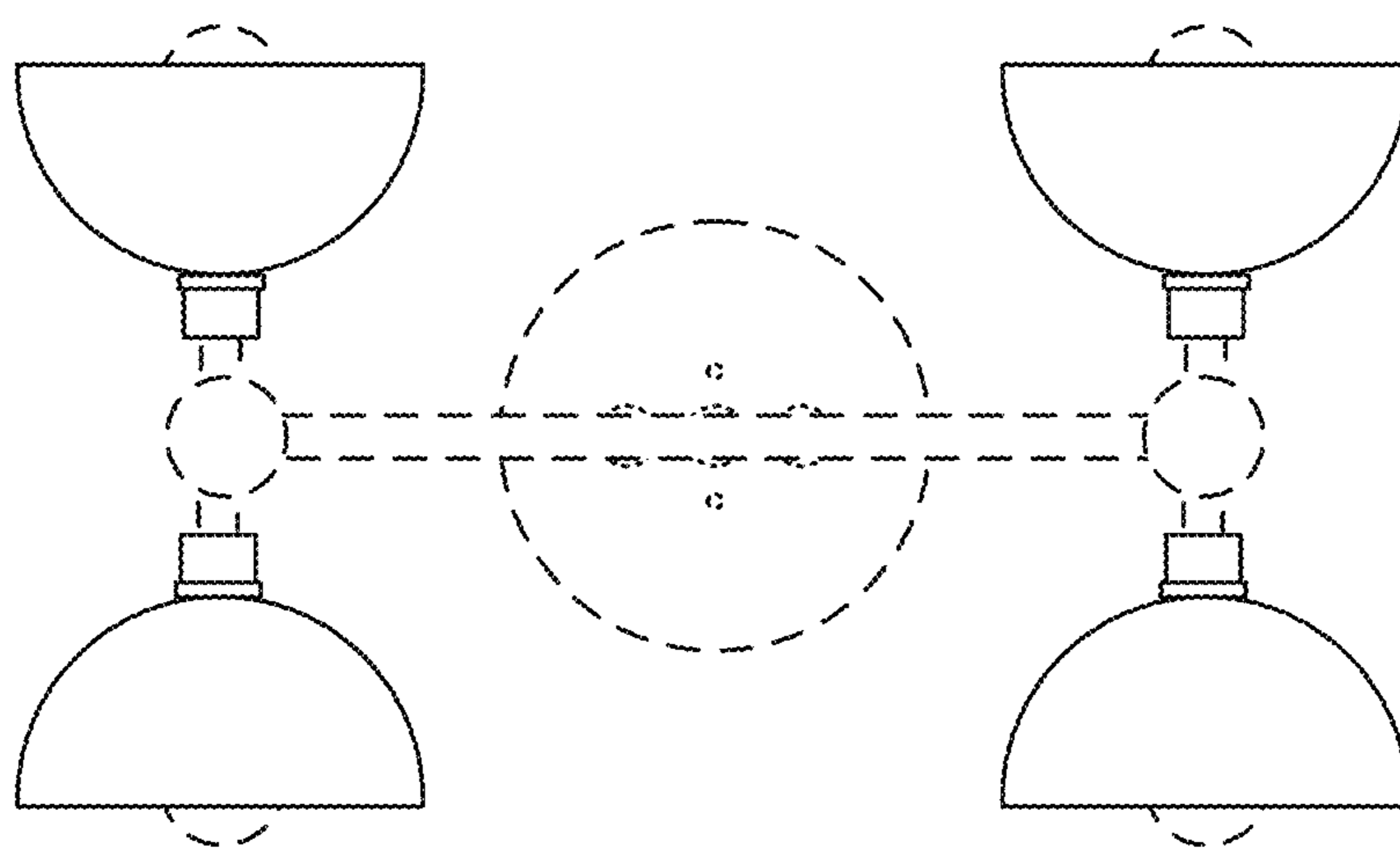
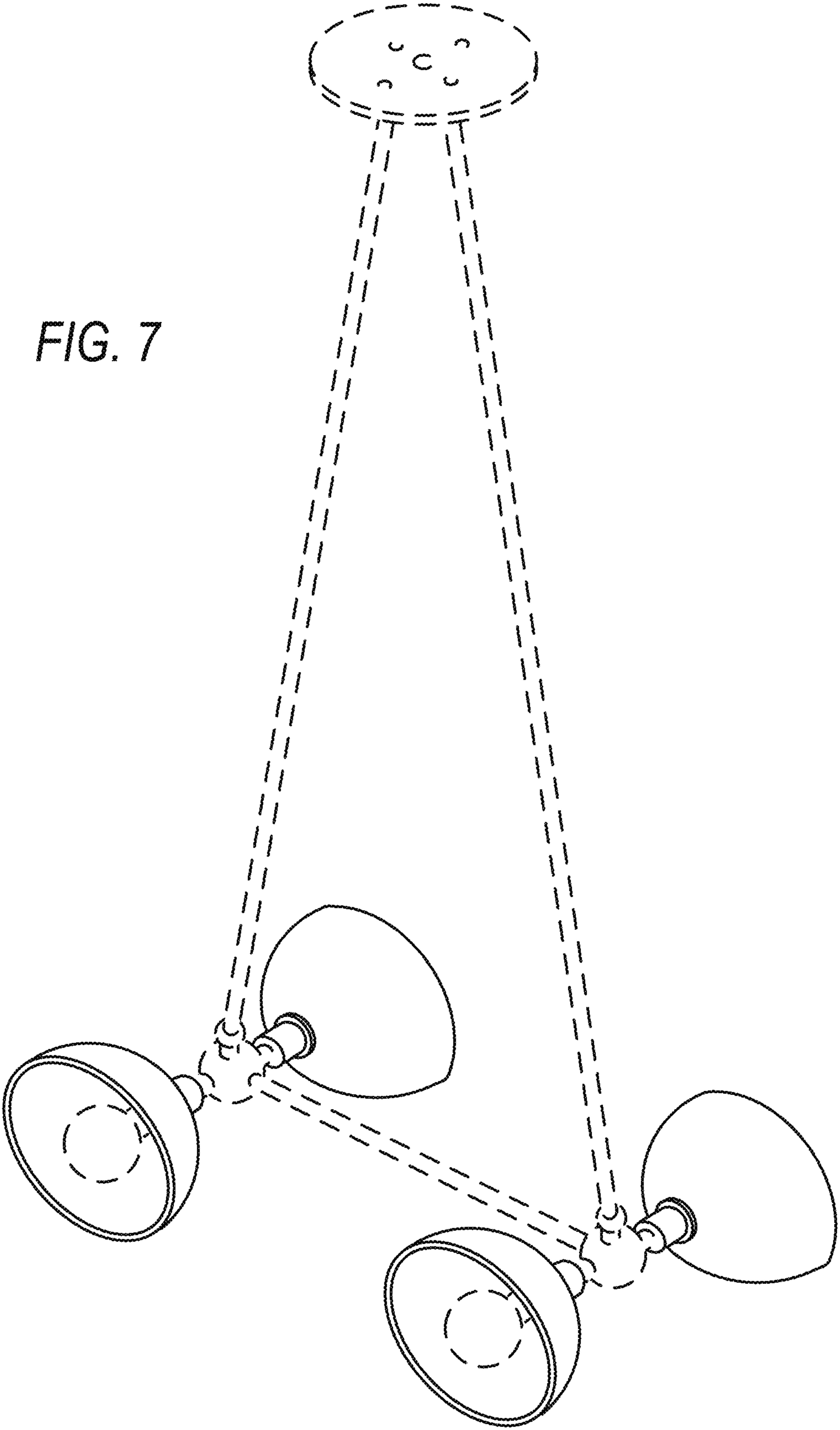

FIG. 6

FIG. 7



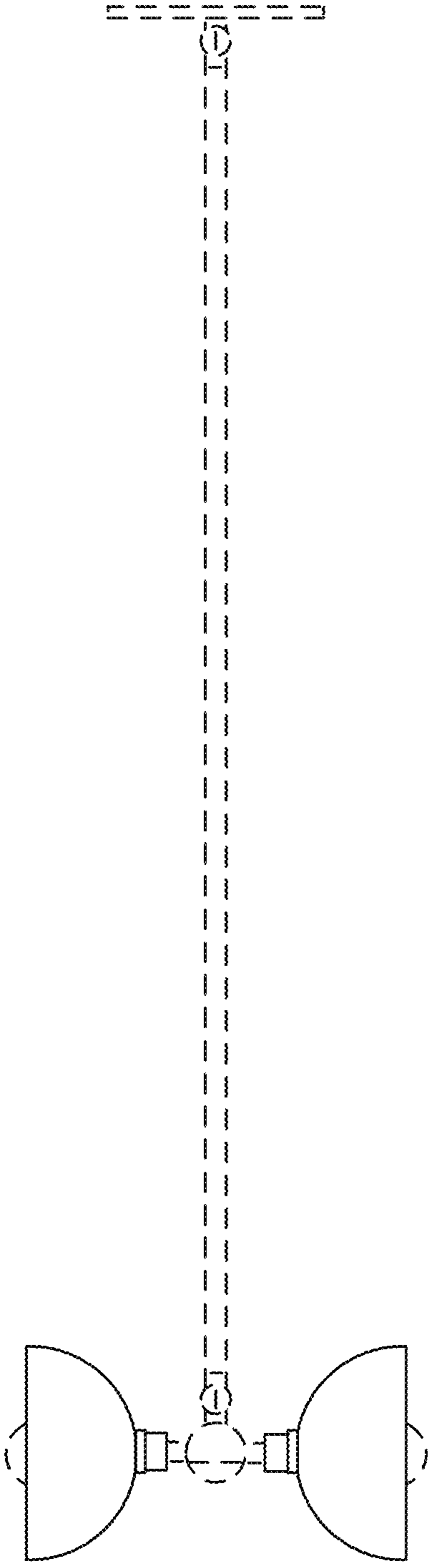

FIG. 8

FIG. 9

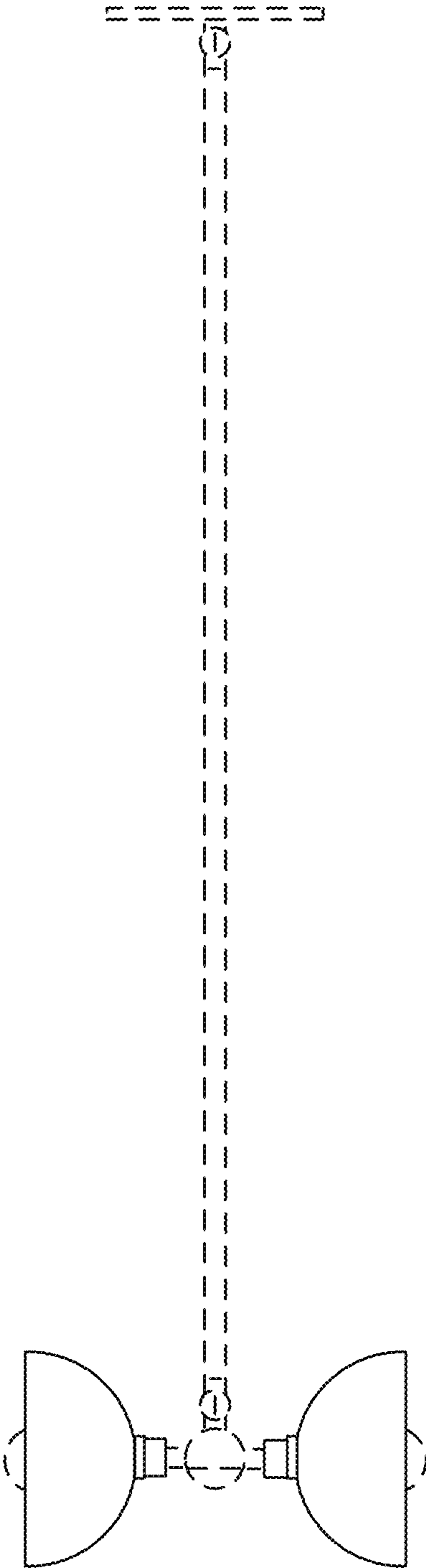

FIG. 10

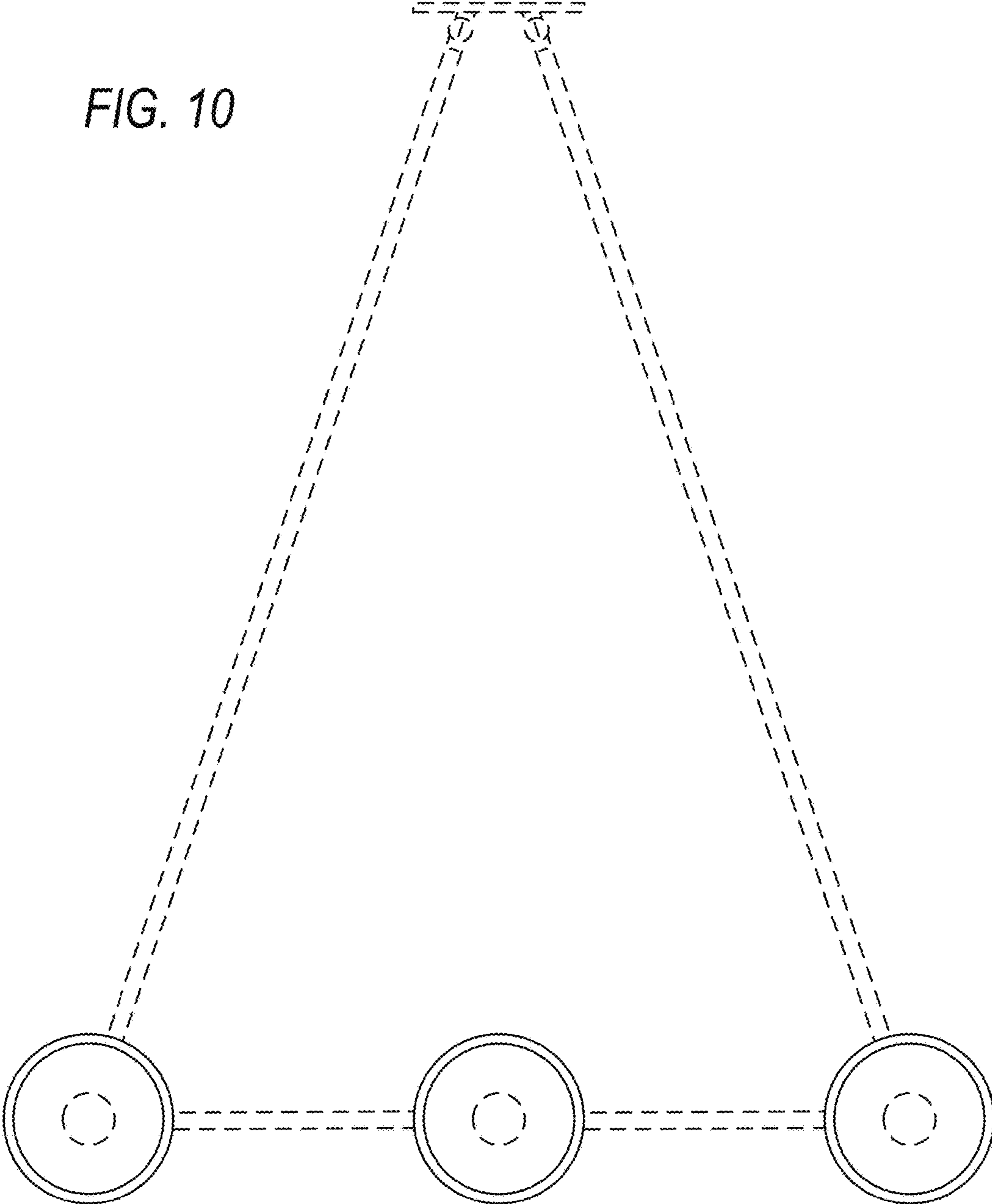
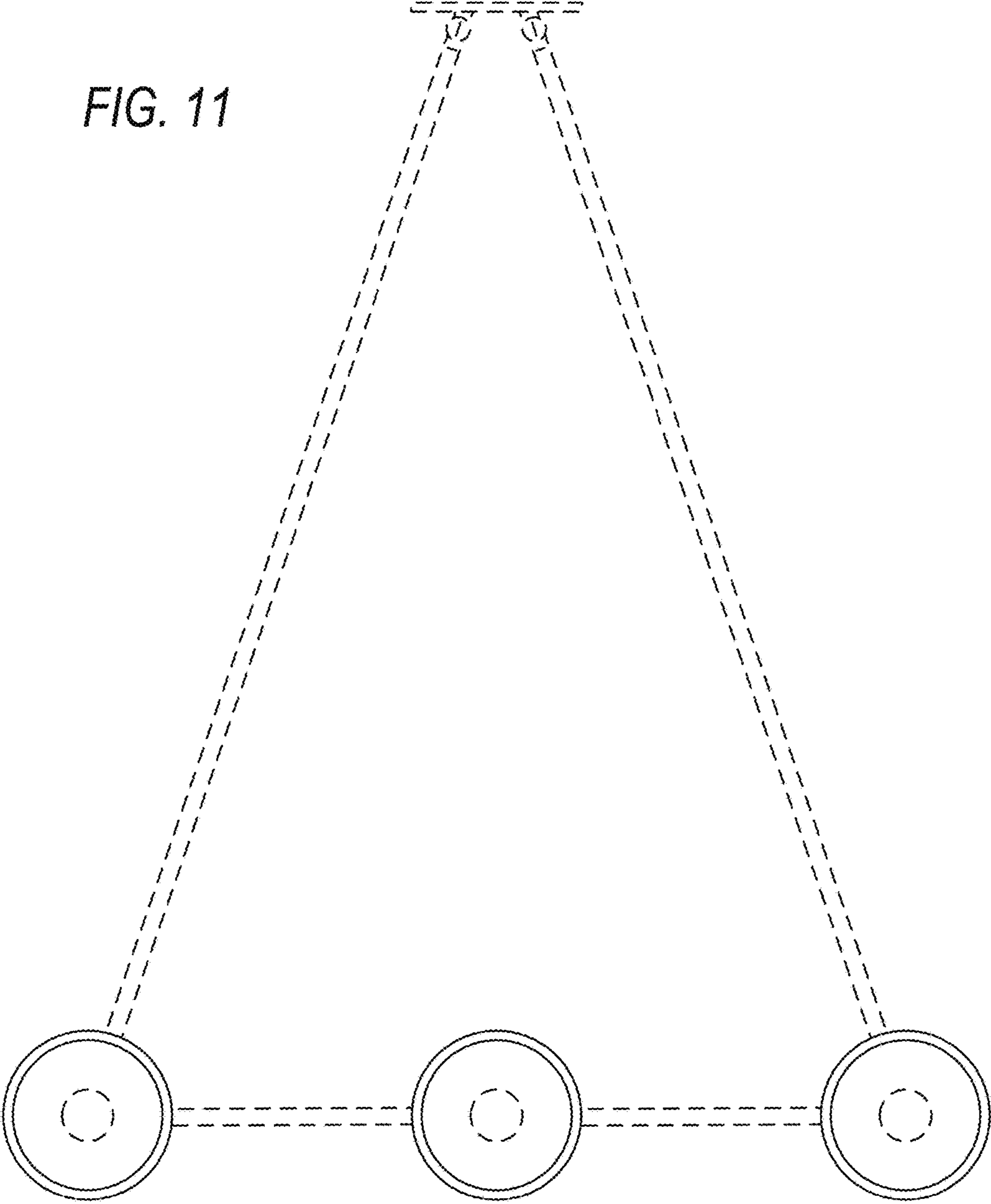

FIG. 11



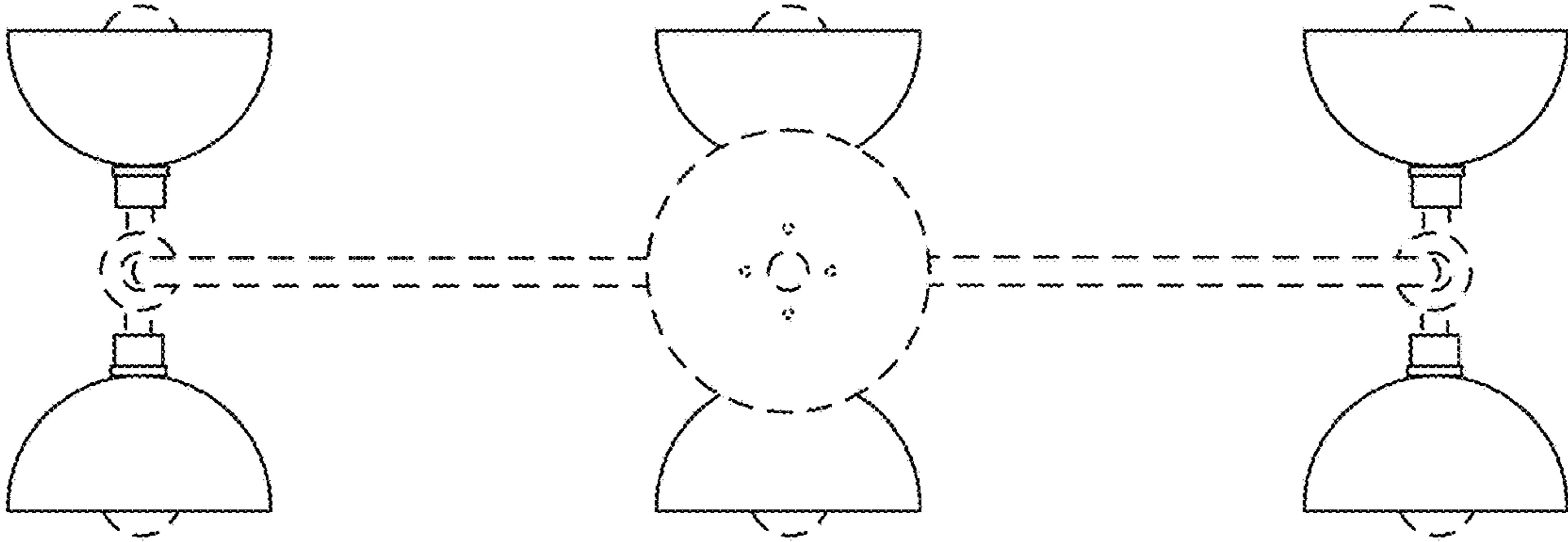

FIG. 12

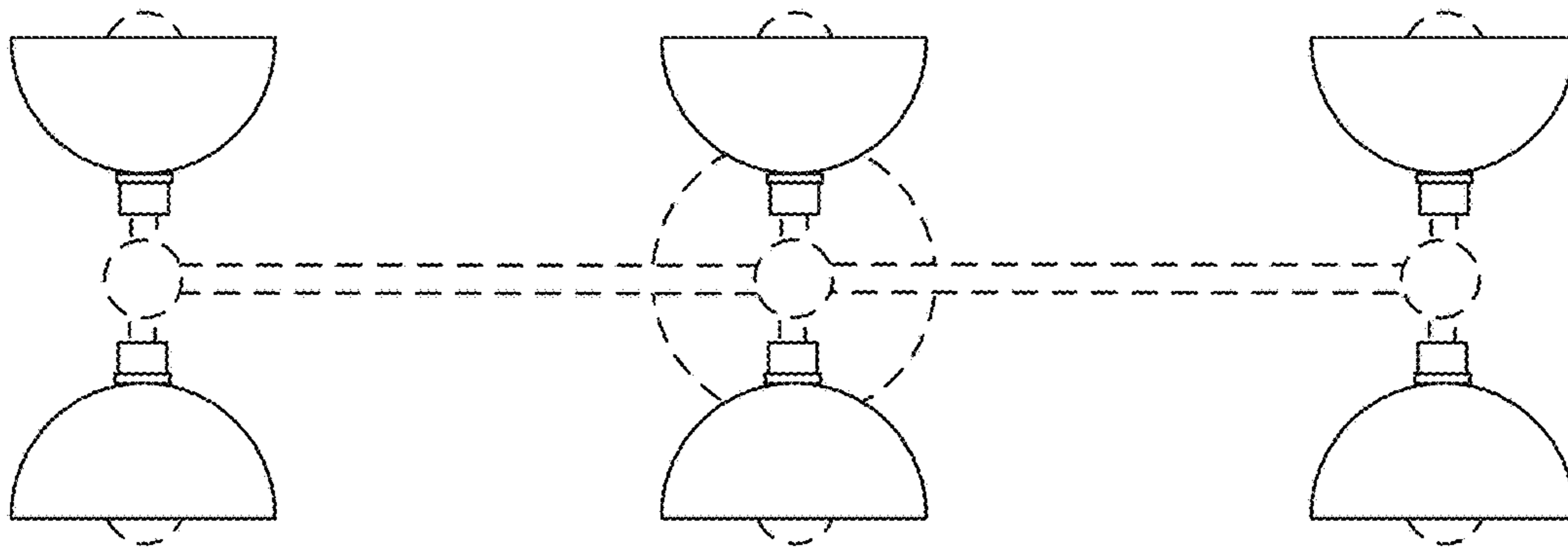

FIG. 13

FIG. 14

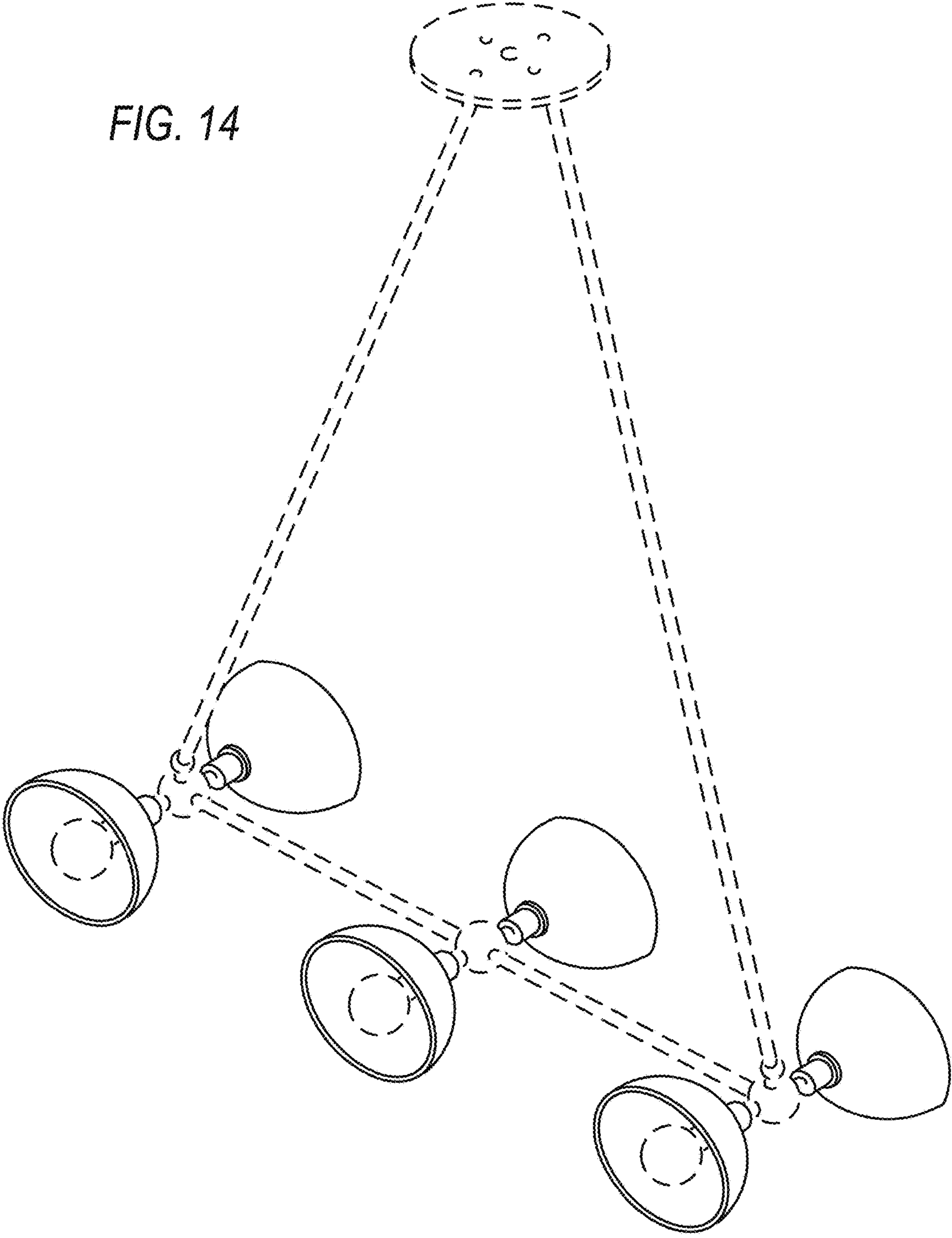

FIG. 15

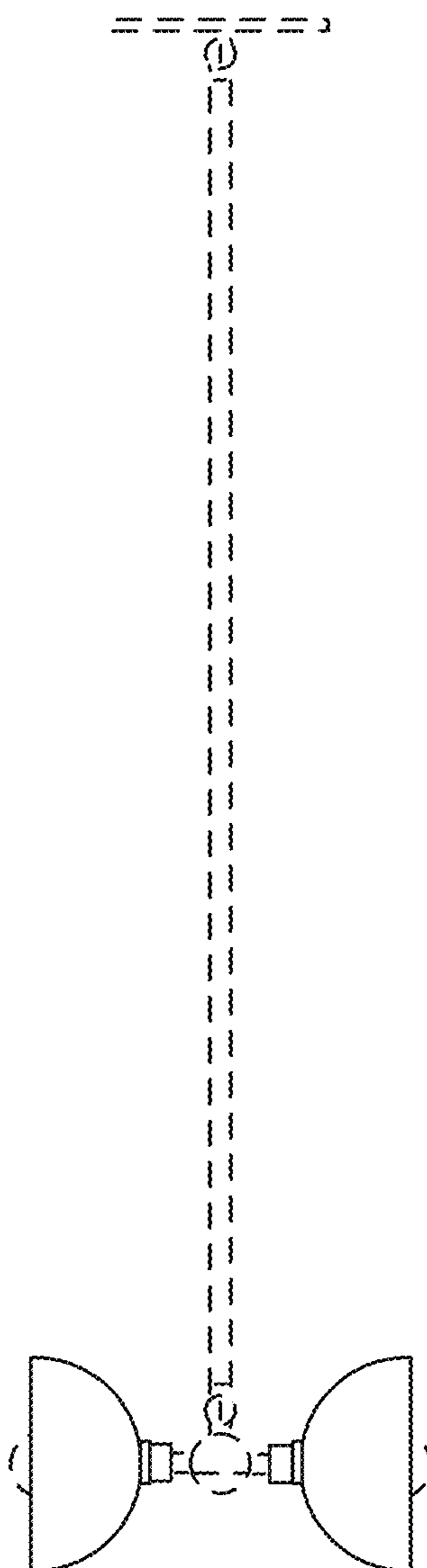
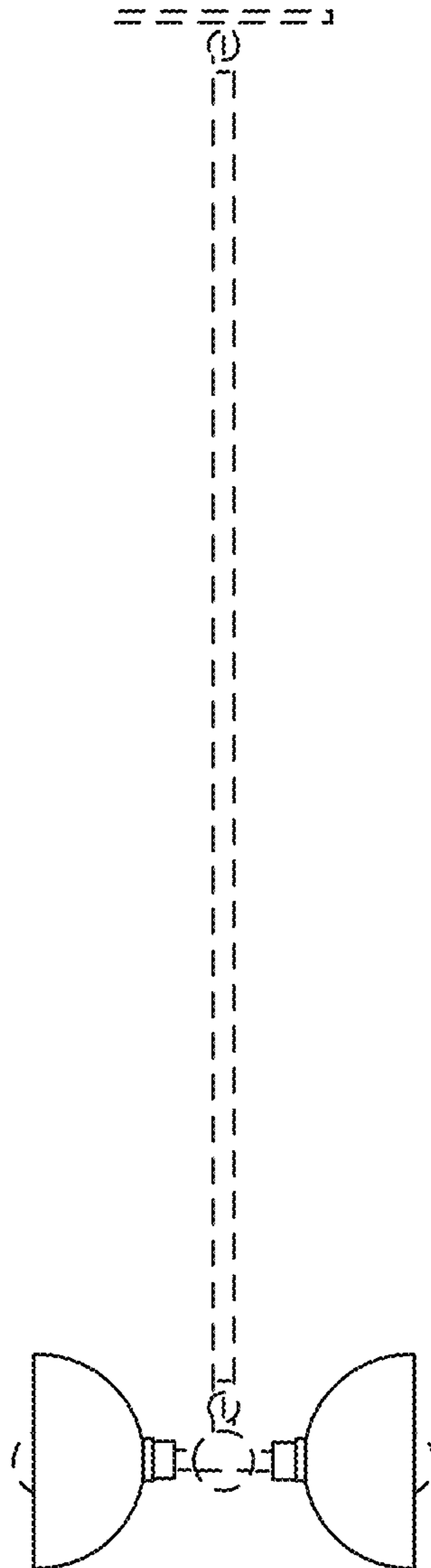

FIG. 16



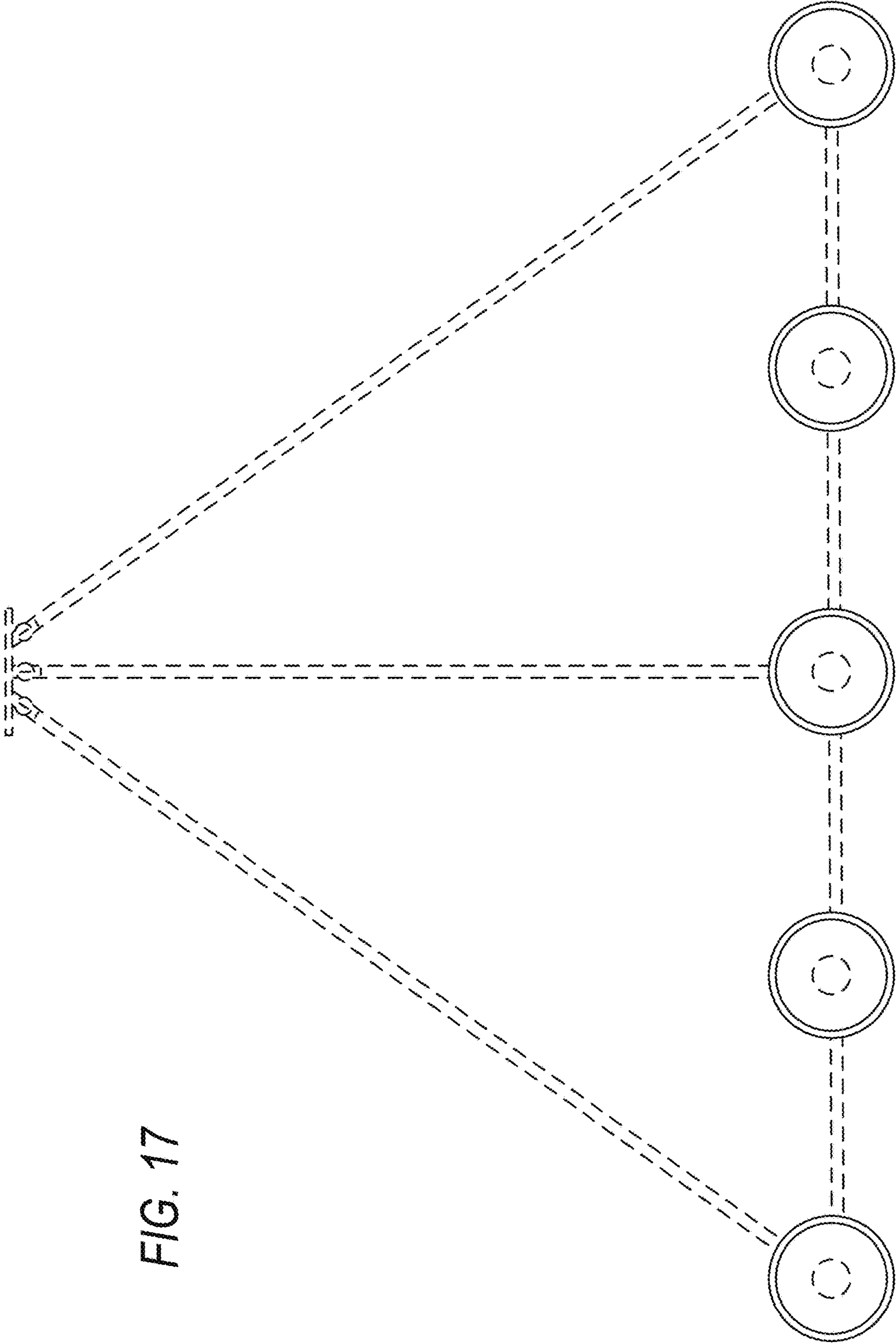

FIG. 17

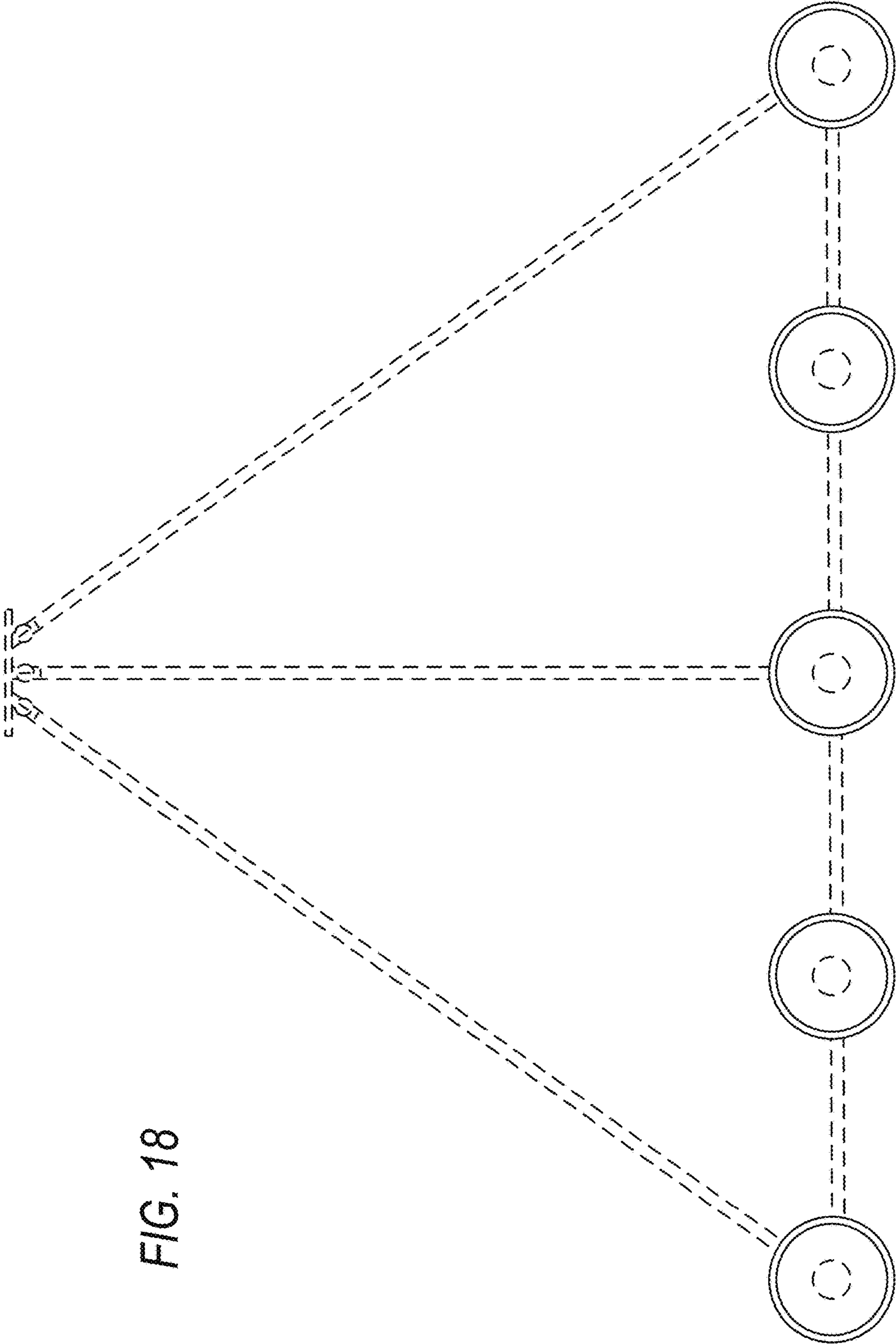

FIG. 18

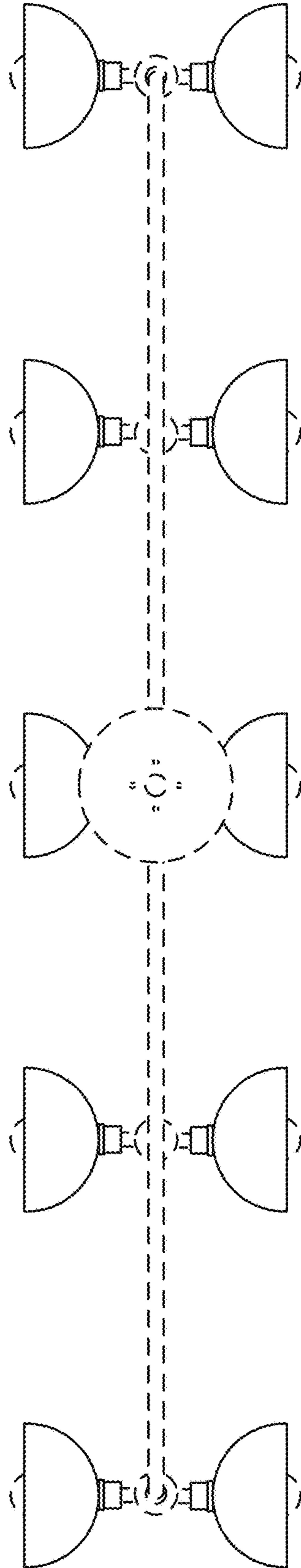

FIG. 19

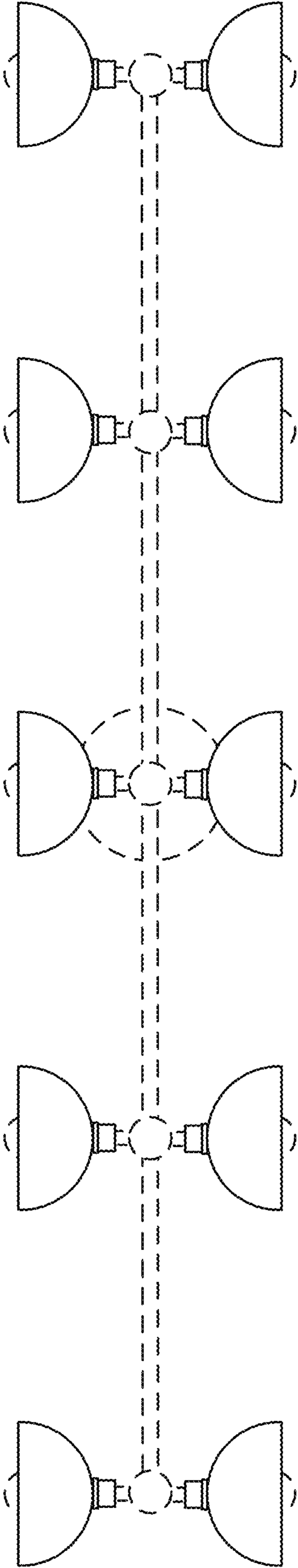

FIG. 20

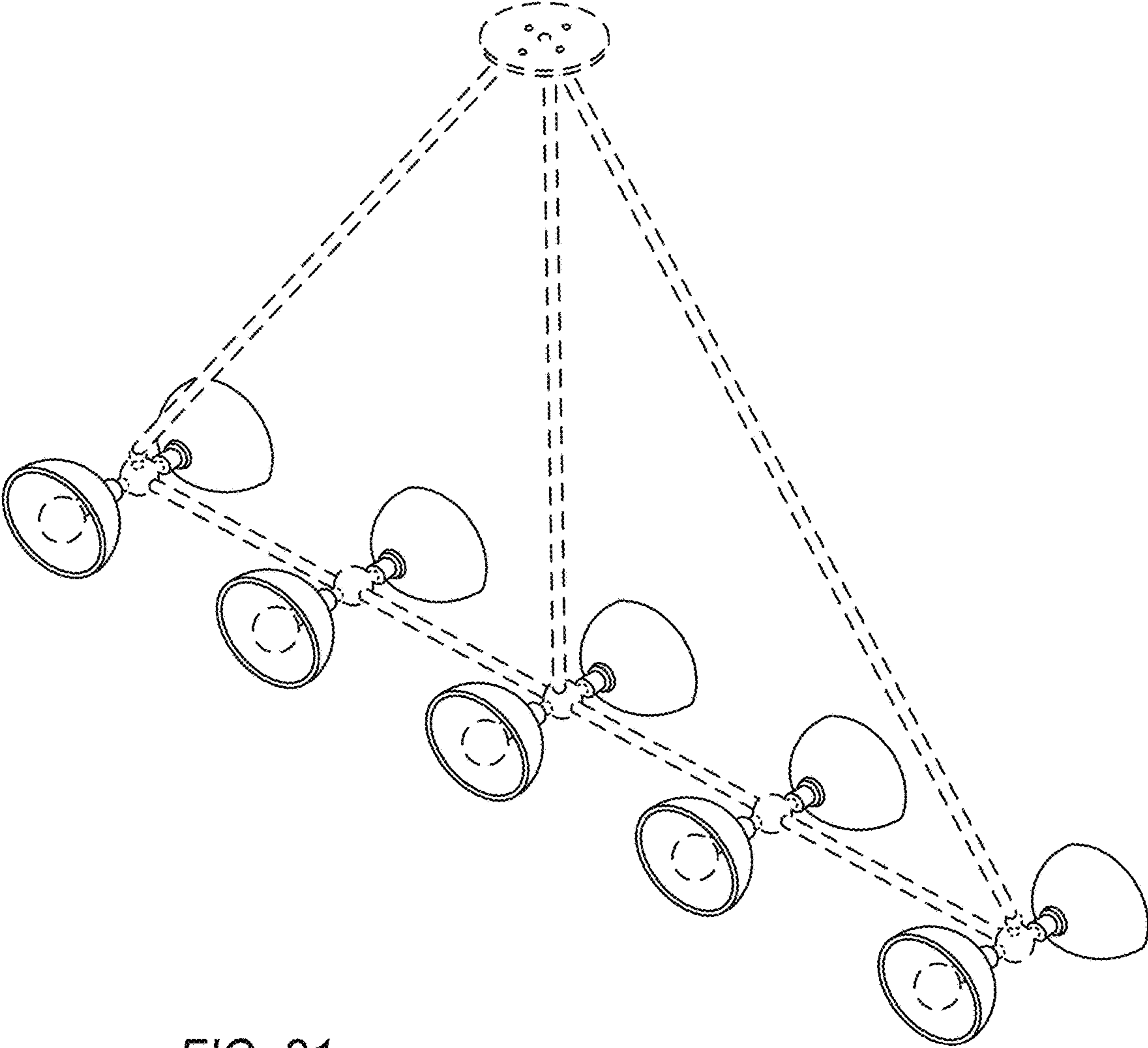

FIG. 21