



US00D779681S

(12) **United States Design Patent** (10) **Patent No.:** **US D779,681 S**  
**Grommet** (45) **Date of Patent:** **\*\* Feb. 21, 2017**

(54) **STAIRCASE**

(71) Applicant: **Acutech, LLC**, Columbia Falls, MT (US)  
 (72) Inventor: **Dean G Grommet**, Whitefish, MT (US)  
 (\*\*) Term: **15 Years**  
 (21) Appl. No.: **29/533,290**

(22) Filed: **Jul. 15, 2015**  
 (51) **LOC (10) Cl.** ..... **25-04**  
 (52) **U.S. Cl.**  
 USPC ..... **D25/63**  
 (58) **Field of Classification Search**  
 USPC ..... D25/62-69; 52/182, 188, 741.2, 191,  
 52/184, 190, 187; D10/1-29  
 CPC ..... E04F 11/035; E04F 11/112; E04F 11/104;  
 E04F 11/025  
 See application file for complete search history.

(56) **References Cited**

**U.S. PATENT DOCUMENTS**

4,457,398 A *	7/1984	Loix	.....	E04F 11/025 182/151
5,493,823 A *	2/1996	Baldi	.....	E04F 11/00 52/182
D640,015 S *	6/2011	Birck	.....	D25/63
9,121,185 B2 *	9/2015	Grenier	.....	E04F 11/108
9,212,491 B1 *	12/2015	Santini	.....	E04F 11/035
2005/0097835 A1 *	5/2005	Nishimoto	.....	E04F 11/0226 52/182

(Continued)

**OTHER PUBLICATIONS**

“A structural gem” EVstudio. , N.p., Jun. 10, 2015. Web. Apr. 18, 2016.\*

(Continued)

*Primary Examiner* — Cynthia Ramirez

*Assistant Examiner* — Gino Colan

(74) *Attorney, Agent, or Firm* — Robin Kelson Consulting

(57) **CLAIM**

The ornamental design for a staircase, as shown and described.

**DESCRIPTION**

FIG. 1 is a perspective view of a staircase in accordance with the present design.

FIG. 2 is a front view for the staircase shown in FIG. 1.

FIG. 3 is a rear view for the staircase shown in FIG. 1.

FIG. 4 is a right side view for the staircase shown in FIG. 1, it being understood that the opposite (left) side not shown is a substantial mirror image thereof.

FIG. 5 is a top view for the staircase shown in FIG. 1.

FIG. 6 is a bottom view for the staircase shown in FIG. 1.

FIG. 7 is a view from beneath the staircase shown in FIG. 1, looking up at it as if from the floor below.

FIG. 8 is a view from above the staircase shown in FIG. 1, looking down at it as if from the floor above.

FIG. 9 is a rear perspective view for the staircase shown in FIG. 1; and,

FIG. 10 is a side perspective view for the staircase shown in FIG. 1.

The dash-dash broken lines in the drawings are included for the purpose of illustrating portions of the staircase and form no part of the claimed design. The dash-dot broken lines in the drawings represent the boundaries of the claimed design and form no part thereof.

**1 Claim, 9 Drawing Sheets**

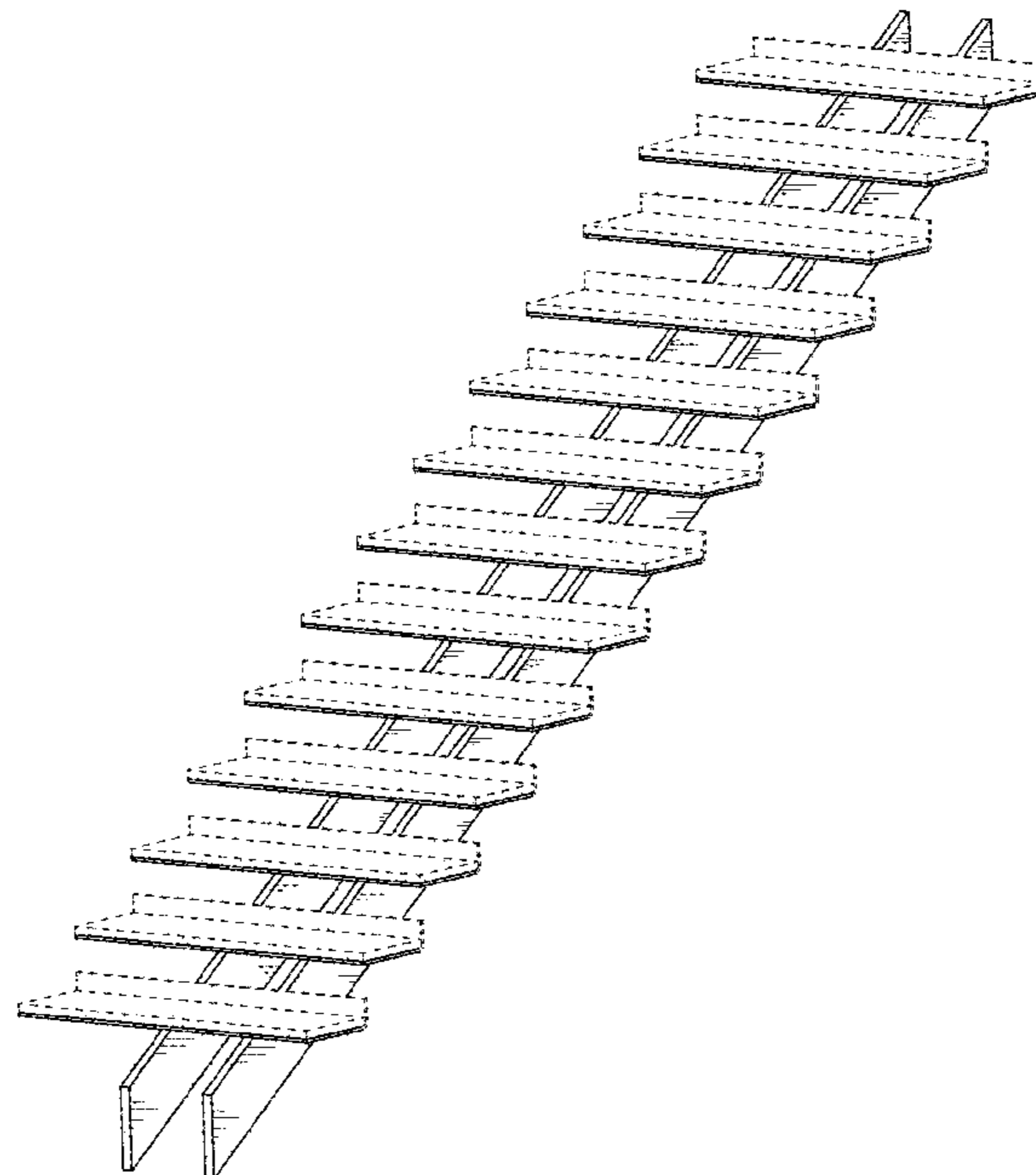

(56)

**References Cited**

U.S. PATENT DOCUMENTS

2009/0139161 A1\* 6/2009 Teckam ..... E04F 11/0255  
52/182  
2012/0011786 A1\* 1/2012 Turner ..... E04F 11/025  
52/182  
2013/0305635 A1\* 11/2013 McCool ..... E04F 11/163  
52/179  
2014/0373462 A1\* 12/2014 Grenier ..... E04F 11/108  
52/188  
2015/0252568 A1\* 9/2015 Pivetta ..... E04F 11/0255  
52/188

OTHER PUBLICATIONS

“Alameda metalworks” Alameda Metalworks. N.p., 2008. Web.  
Apr. 18, 2016.\*

“Double under Mount Plate Stringer with Side Mounted Glass-  
Metal & Wood” Metal \$ Wood. N.p., n.d. Web. Apr. 18, 2016.\*

\* cited by examiner

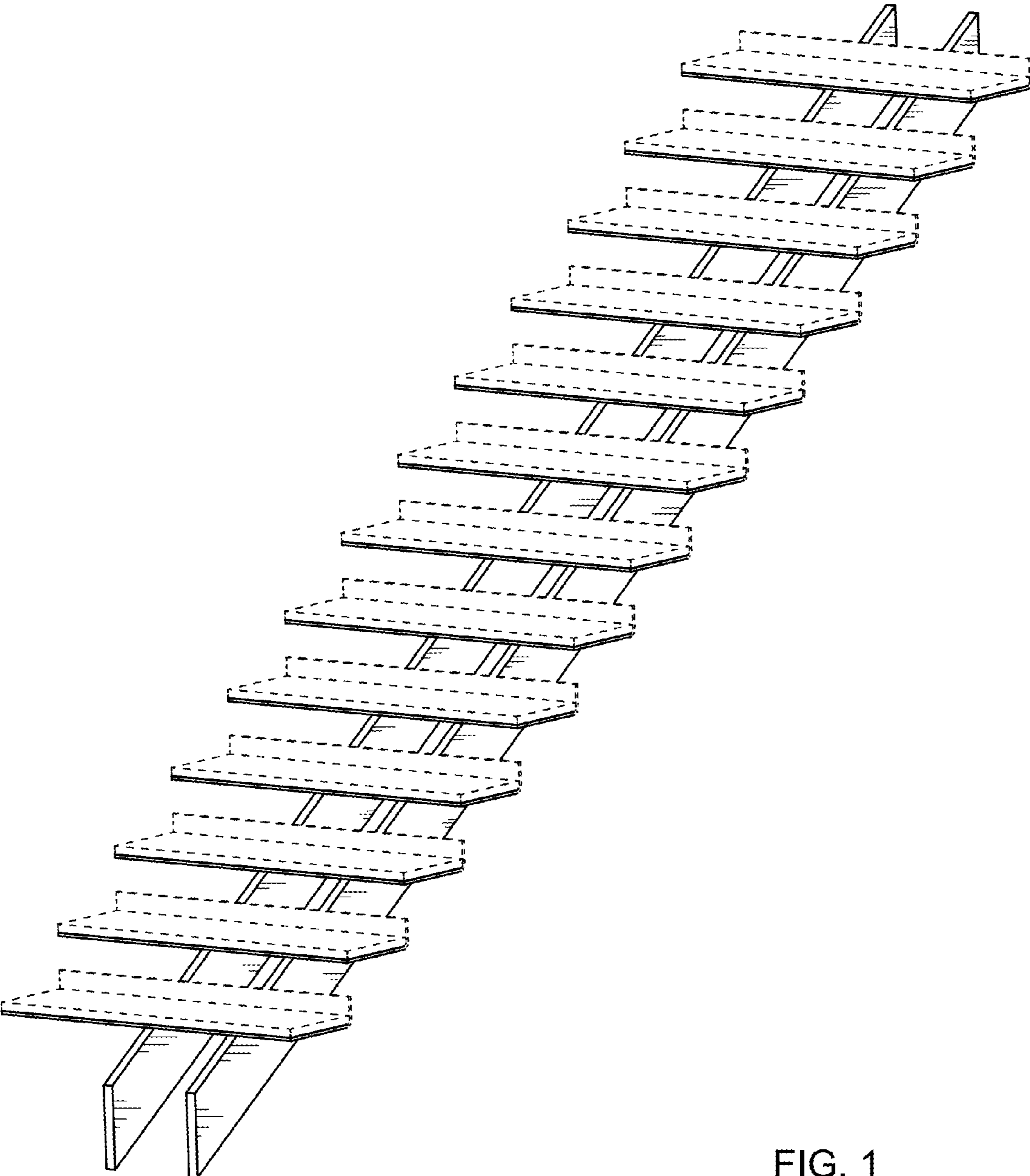

FIG. 1

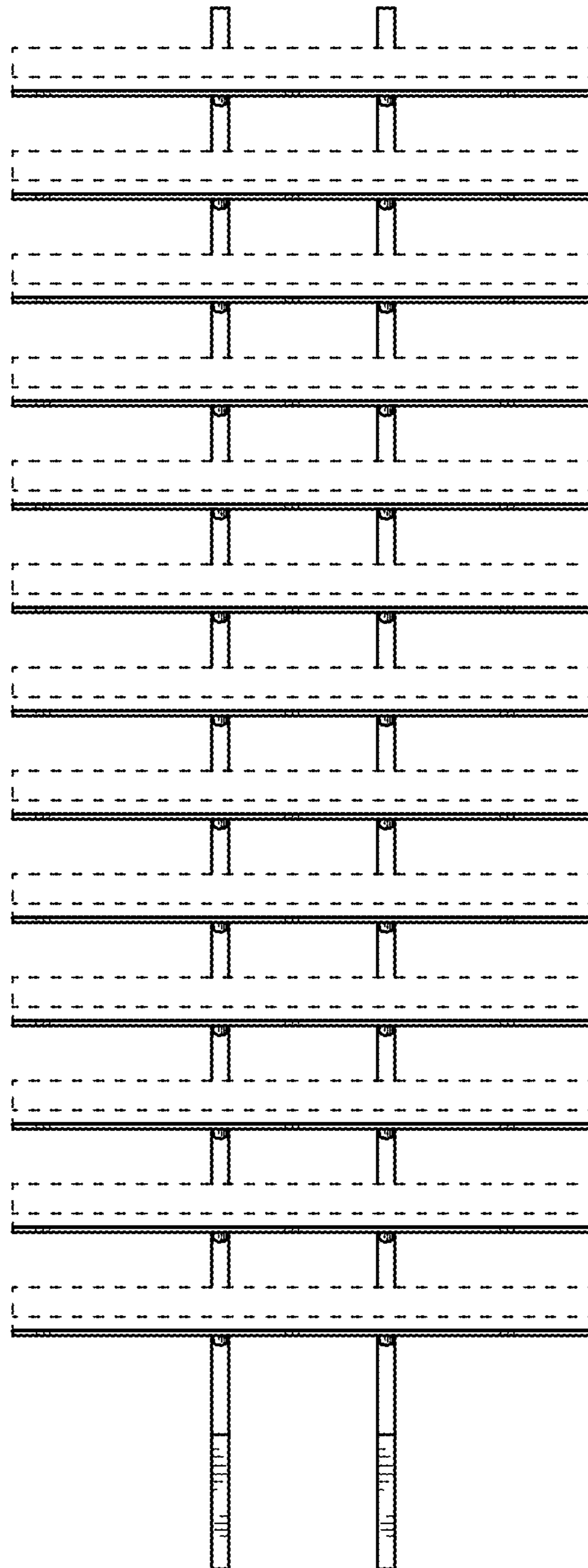

FIG. 2

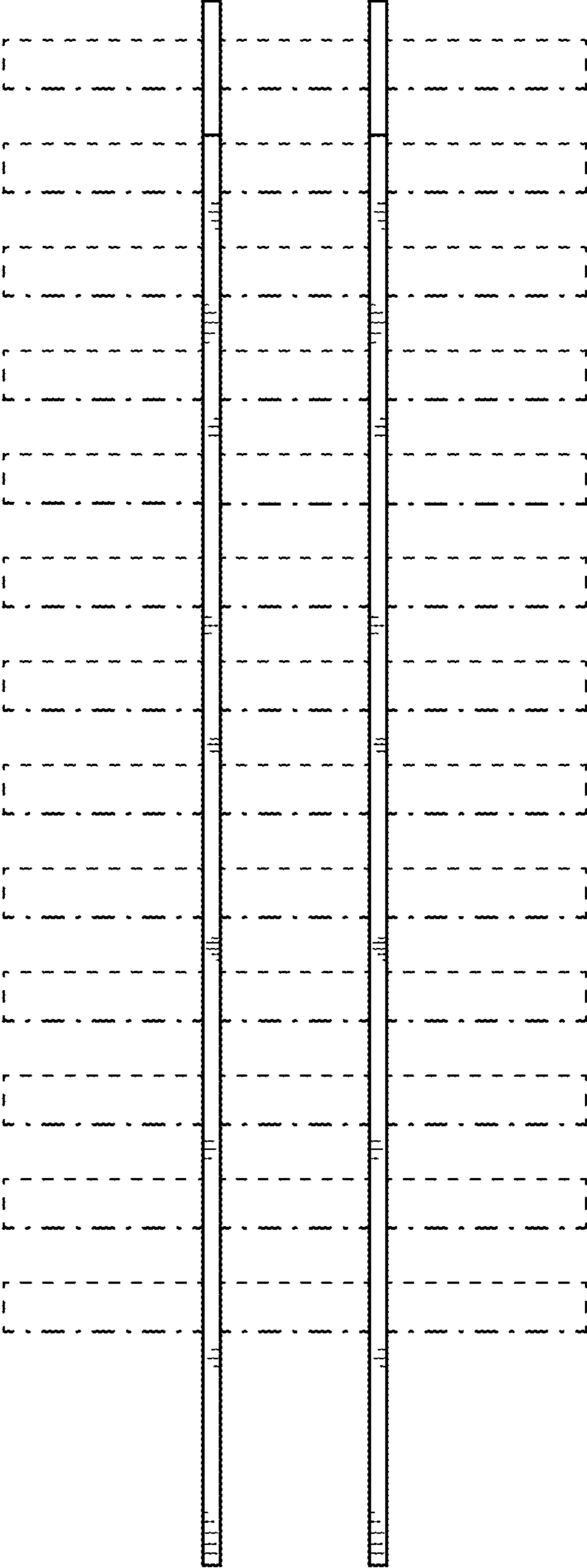

FIG. 3

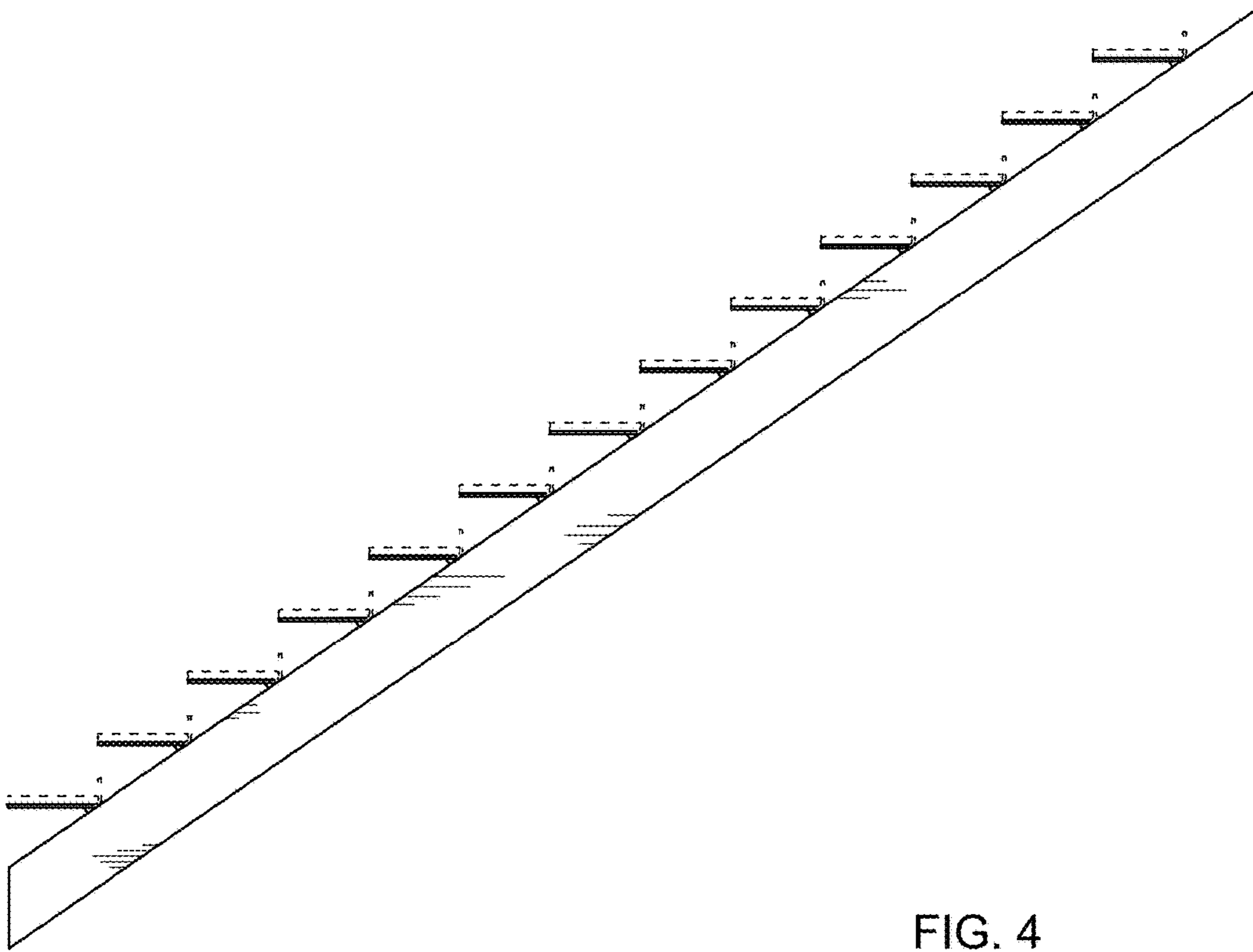

FIG. 4

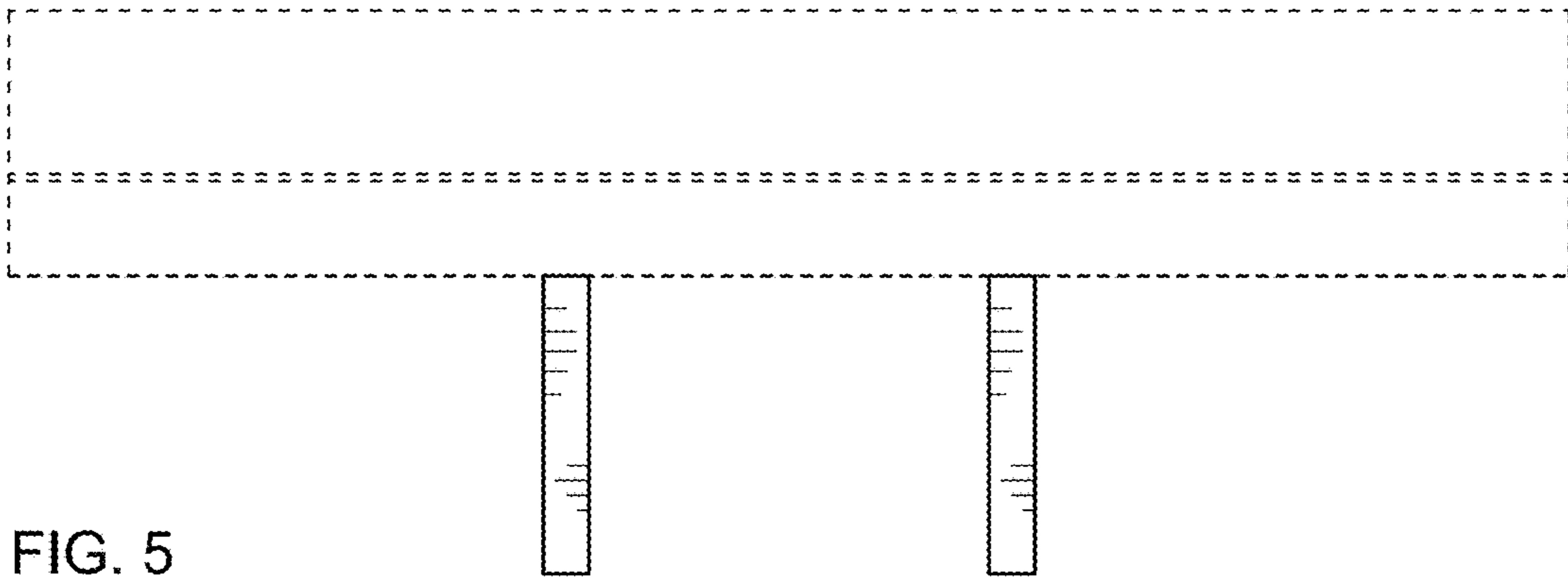

FIG. 5

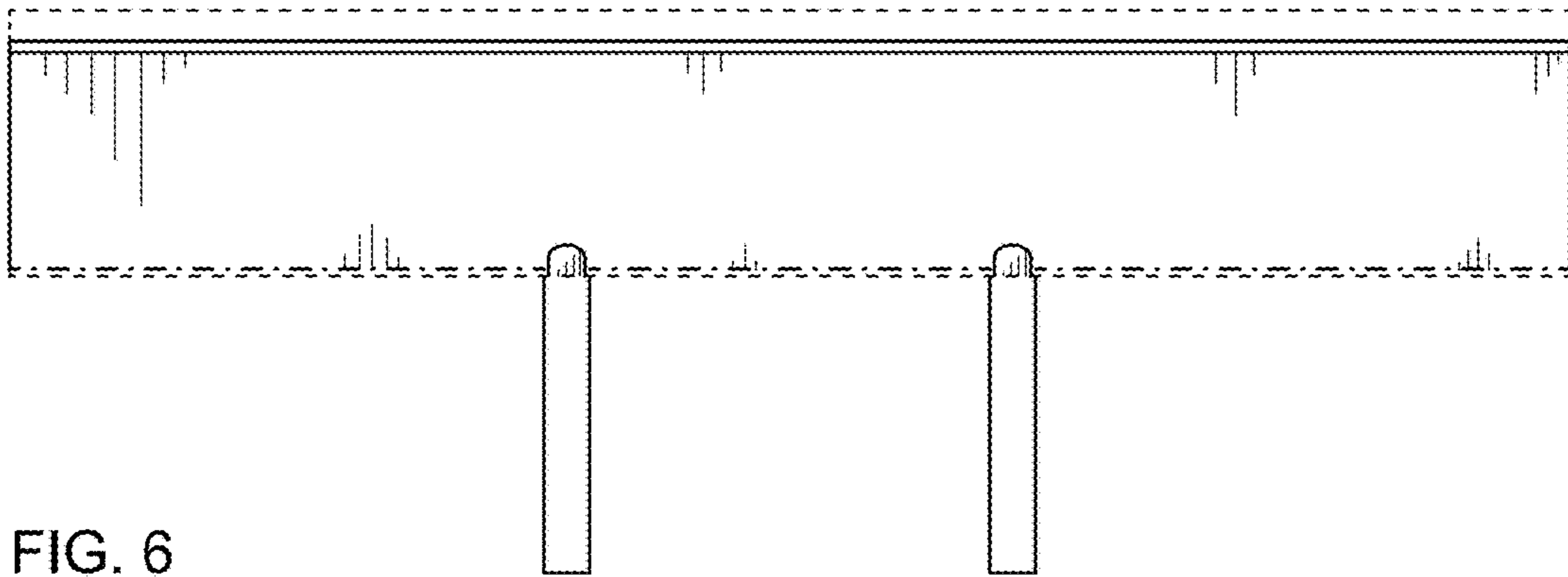

FIG. 6

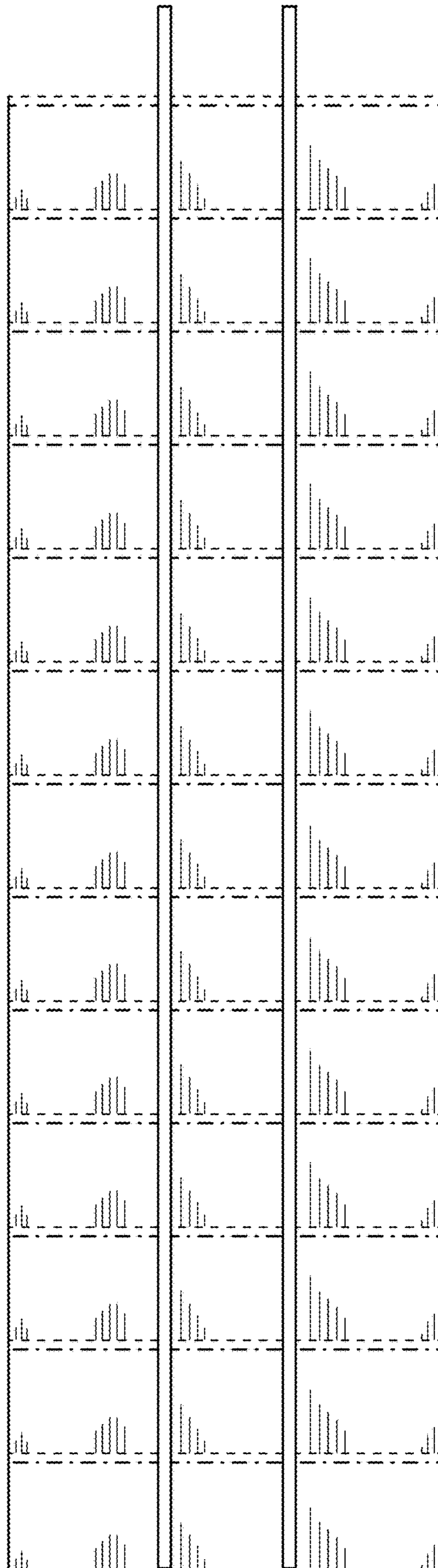

FIG. 7



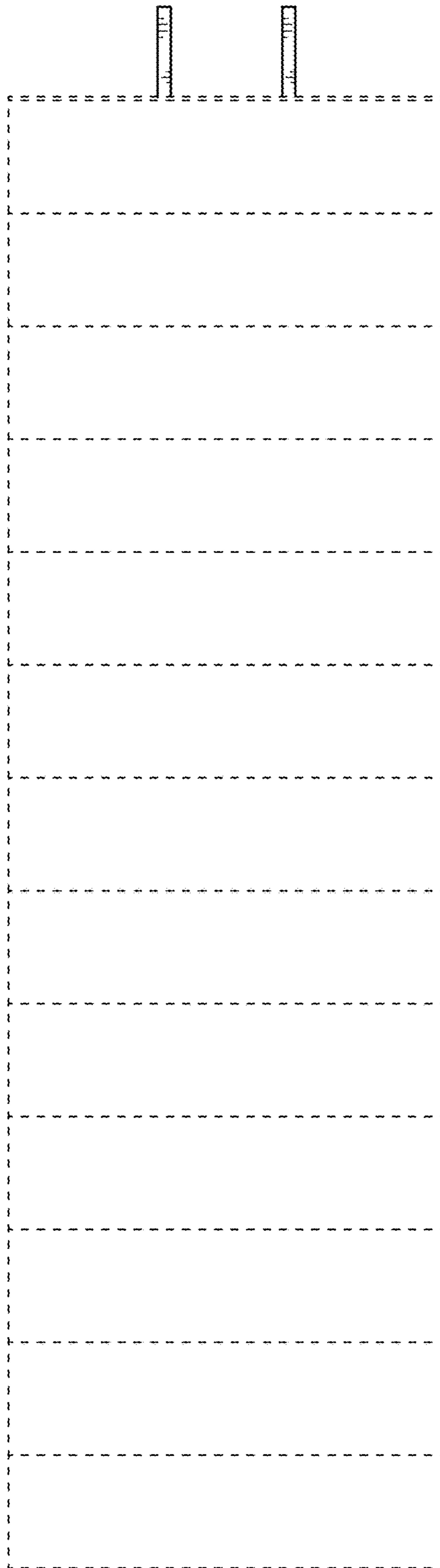

FIG. 8

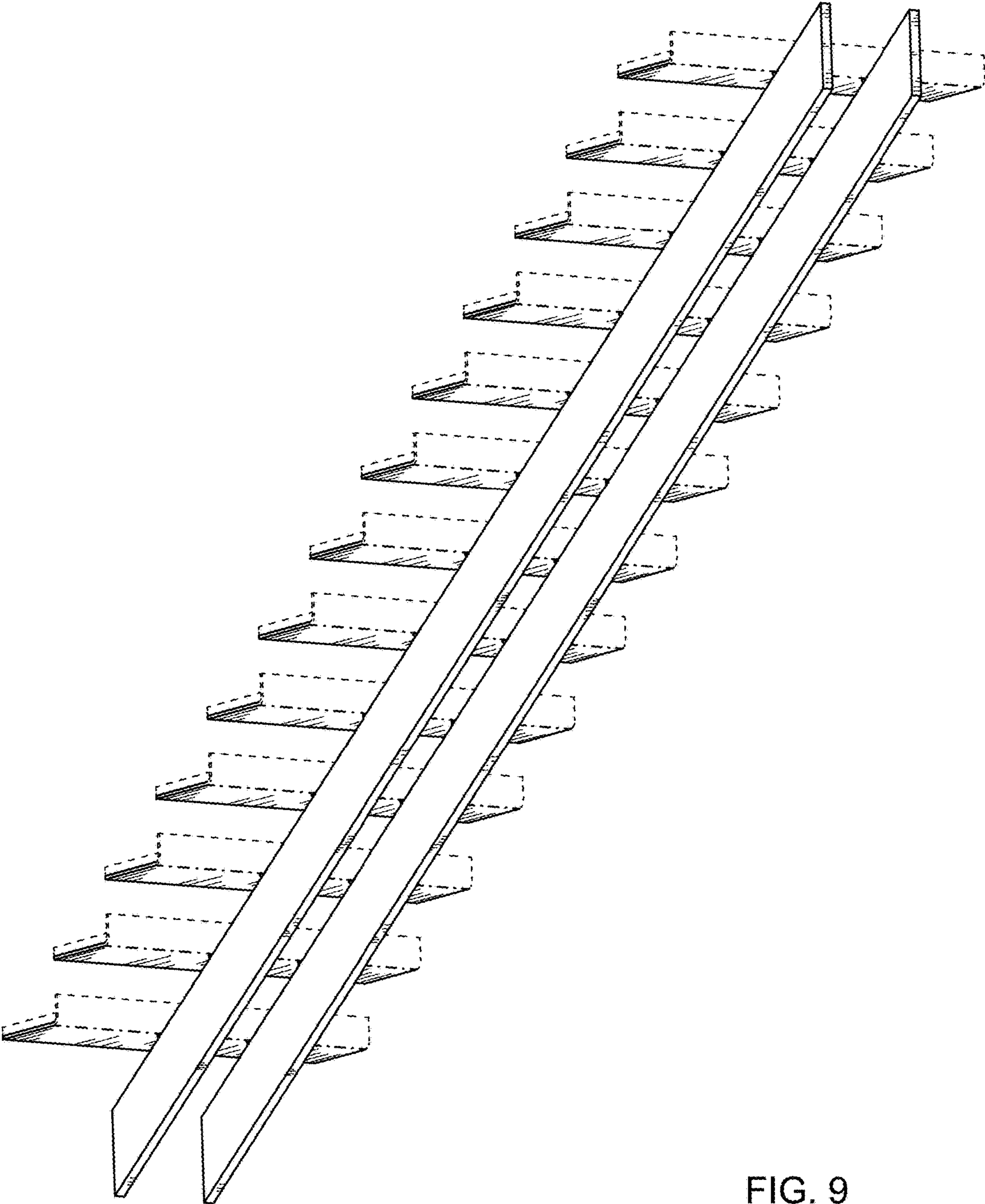

FIG. 9

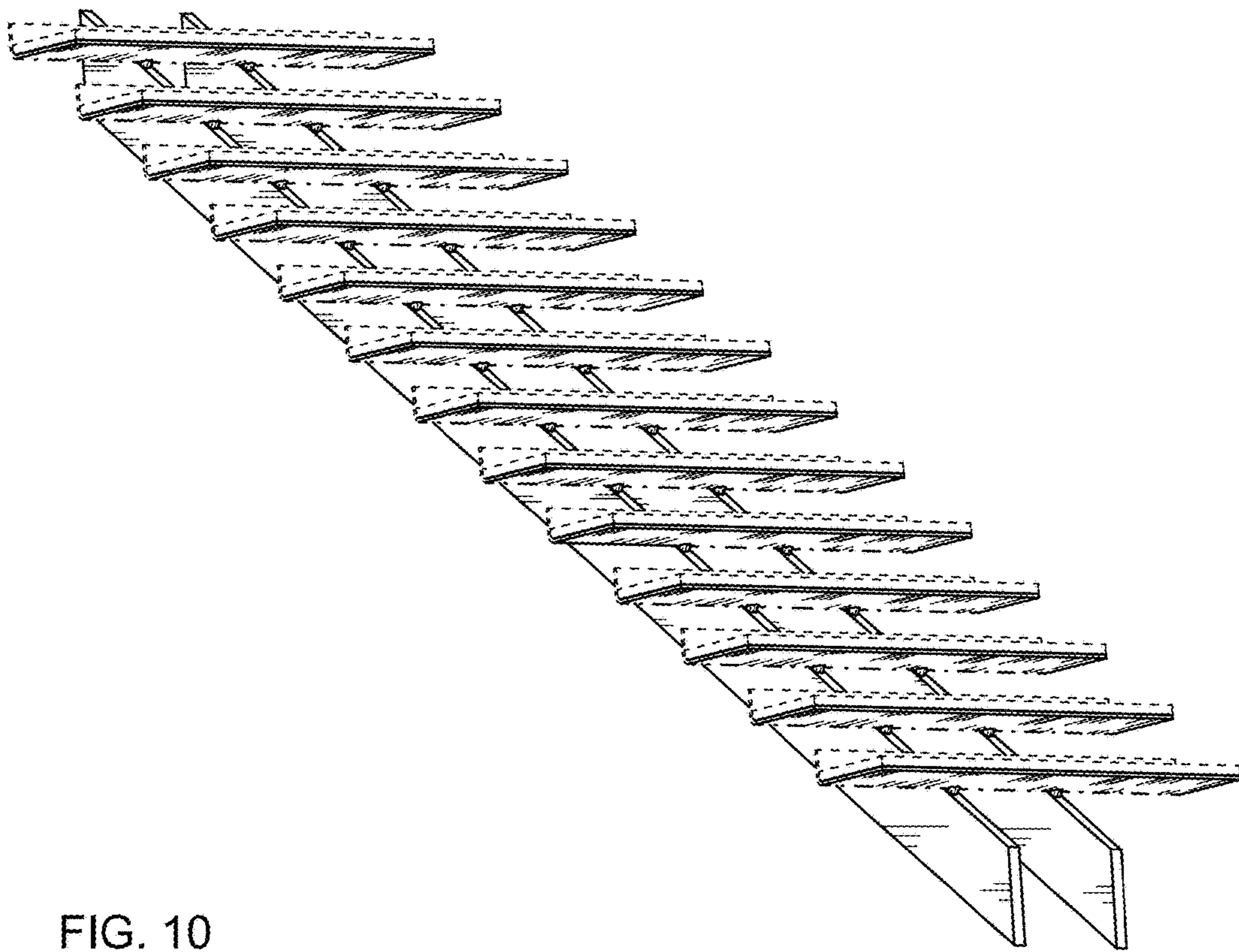

FIG. 10