



US00D779590S

(12) **United States Design Patent** (10) **Patent No.:** **US D779,590 S**  
**Pryor** (45) **Date of Patent:** **\*\* Feb. 21, 2017**

(54) **INDEXING TAB**

(71) Applicant: **Daniel Lee Pryor**, Bothell, WA (US)

(72) Inventor: **Daniel Lee Pryor**, Bothell, WA (US)

(\*\*) Term: **15 Years**

(21) Appl. No.: **29/532,372**

(22) Filed: **Jul. 6, 2015**

**Related U.S. Application Data**

(62) Division of application No. 29/459,461, filed on Jun. 28, 2013, now Pat. No. Des. 733,797.

(51) **LOC (10) Cl.** ..... **19-01**

(52) **U.S. Cl.**  
USPC ..... **D19/1**

(58) **Field of Classification Search**

USPC D19/1-12, 20-34, 78, 87, 91, 100; D20/10, D20/22, 27, 40, 42, 11; D14/435; 206/425, 449; 281/3.1, 38, 21.1, 15.1, 16; 283/117, 61-62, 74-75, 72, 103-105, 283/81-82, 94; 235/380-382, 487, 493, 235/488; 462/901, 72, 61; 360/2; 211/11, 211/45, 50; 40/124.01-124.15, 121, 119

(Continued)

(56) **References Cited**

**U.S. PATENT DOCUMENTS**

6,001,209 A \* 12/1999 Papat ..... B42D 5/003  
156/249

D588,197 S \* 3/2009 Lau ..... D19/65  
(Continued)

*Primary Examiner* — Abraham Bahta

(74) *Attorney, Agent, or Firm* — Barry L. Davison; Davis Wright Tremaine LLP

(57) **CLAIM**

The ornamental design for an indexing tab, as shown and described.

**DESCRIPTION**

FIG. 1 is a front perspective view of a first embodiment of an indexing tab showing my new design.

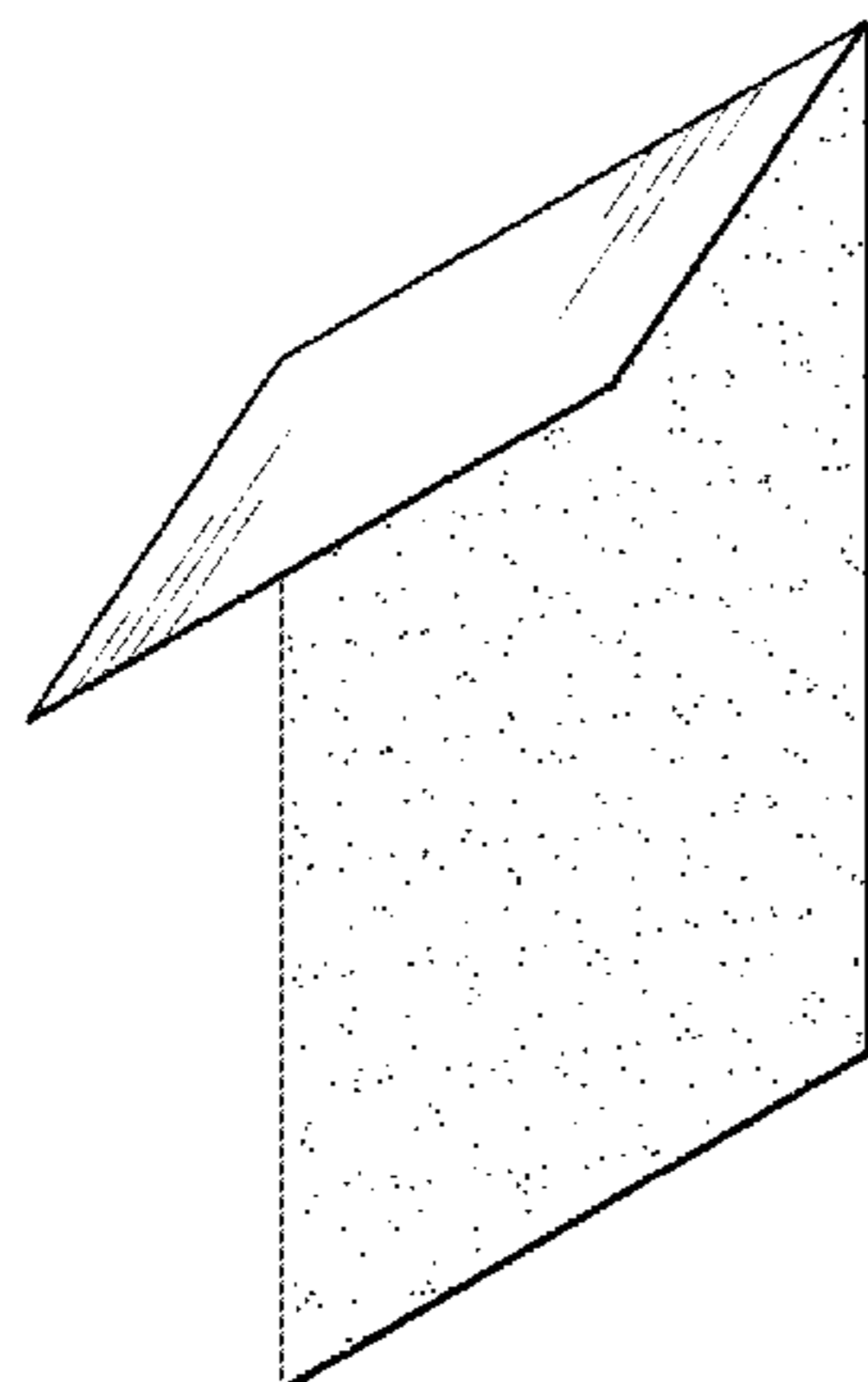


FIG. 2 is a top rear perspective view thereof.

FIG. 3 is a front elevational view thereof.

FIG. 4 is a rear elevational view thereof.

FIG. 5 is a front perspective view thereof, in partially folded configuration.

FIG. 6 is a top rear perspective view thereof, in partially folded configuration.

FIG. 7 is a front perspective view thereof, in completely folded configuration.

FIG. 8 is a top rear perspective view thereof, in completely folded configuration.

FIG. 9 is a front elevational view thereof, in completely folded configuration.

FIG. 10 is a rear elevational view thereof, in completely folded configuration.

FIG. 11 is an enlargement of a portion of the view of FIG. 7.

FIG. 12 is a front perspective view of a second embodiment of an indexing tab showing my new design.

FIG. 13 is a top rear perspective view thereof.

FIG. 14 is a front elevational view thereof.

FIG. 15 is a rear elevational view thereof.

FIG. 16 is a front perspective view thereof, in partially folded configuration.

FIG. 17 is a top rear perspective view thereof, in partially folded configuration.

FIG. 18 is a front perspective view thereof, in completely folded configuration.

FIG. 19 is a top rear perspective view thereof, in completely folded configuration.

FIG. 20 is a front elevational view thereof, in completely folded configuration.

FIG. 21 is a rear elevational view thereof, in completely folded configuration.

FIG. 22 is a front perspective view of a third embodiment of an indexing tab showing my new design.

FIG. 23 is a top rear perspective view thereof.

FIG. 24 is a front elevational view thereof.

FIG. 25 is a rear elevational view thereof.

FIG. 26 is a front perspective view thereof, in partially folded configuration.

FIG. 27 is a top rear perspective view thereof, in partially folded configuration.

(Continued)

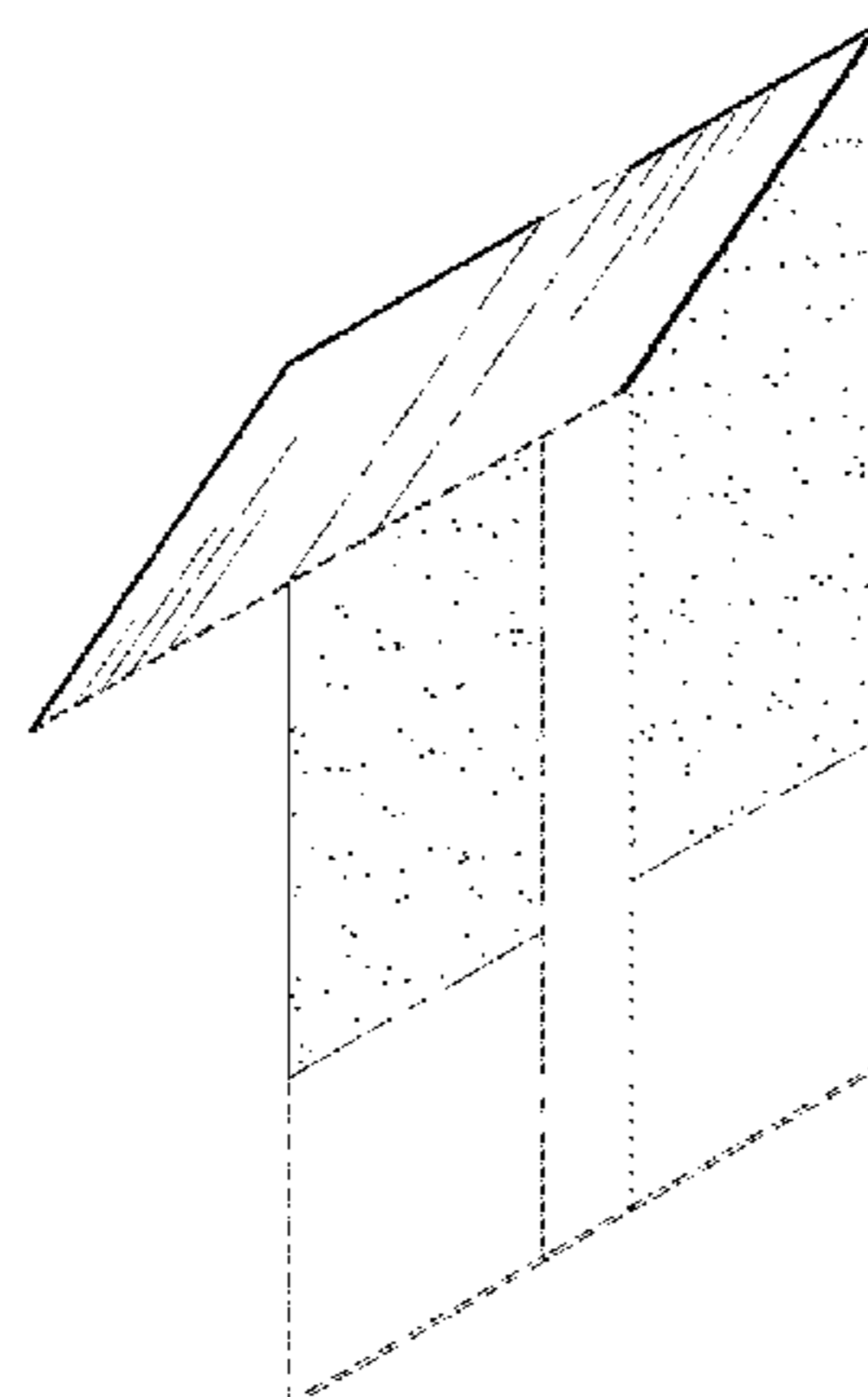


FIG. 28 is a front perspective view thereof, in completely folded configuration.

FIG. 29 is a top rear perspective view thereof, in completely folded configuration.

FIG. 30 is a front elevational view thereof, in completely folded configuration; and,

FIG. 31 is a rear elevational view thereof, in completely folded configuration.

The broken lines are for the purpose of illustrating the environment of the design only and form no part of the claimed design.

The dash-dot lines represent boundaries and form no part thereof

**1 Claim, 9 Drawing Sheets**

(58) **Field of Classification Search**

CPC ... B42D 15/022; B42D 15/042; B42D 15/045;  
B42D 15/027; B42D 25/00; B42D 25/20;  
B42D 25/23; B42D 25/29; B42D 25/30;

B42D 25/285; B42D 2033/00; B42D  
2033/02; B42D 2033/08; B42D 2033/10;  
B42D 2033/28; B42F 19/00; B42F 19/02;  
B42F 19/04; B42F 17/00; B42F  
17/04; B42F 17/06; B42F 17/12; B42F  
17/34; B42F 21/00; B42F 21/02; B42F  
21/06; B42F 21/12

See application file for complete search history.

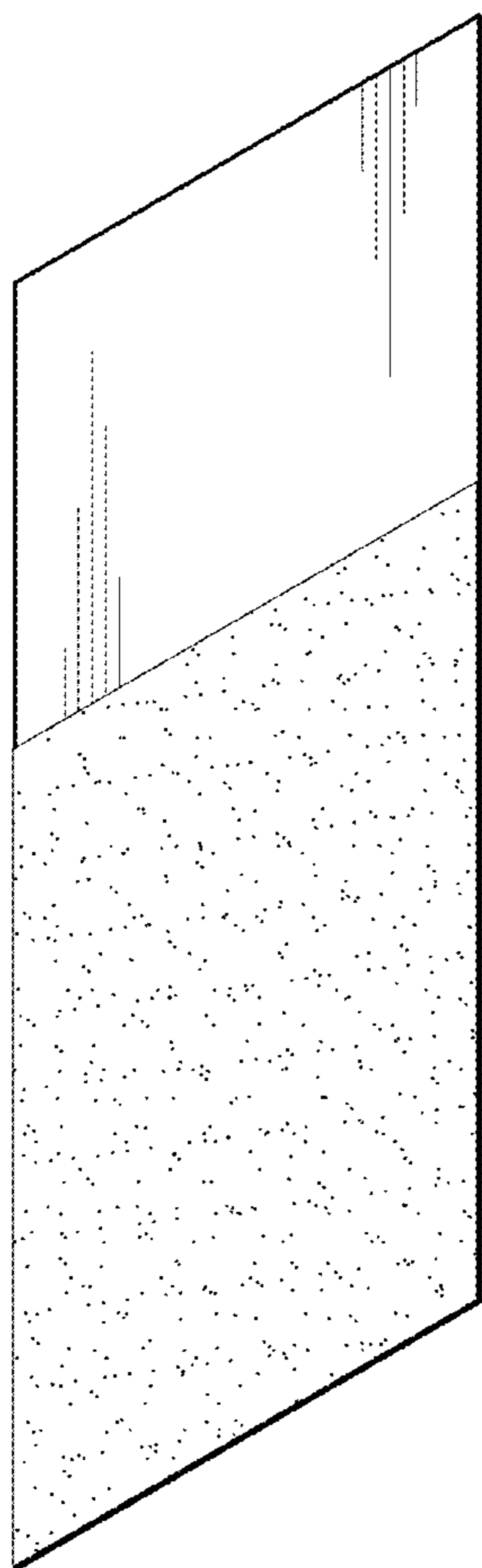
(56)

**References Cited**

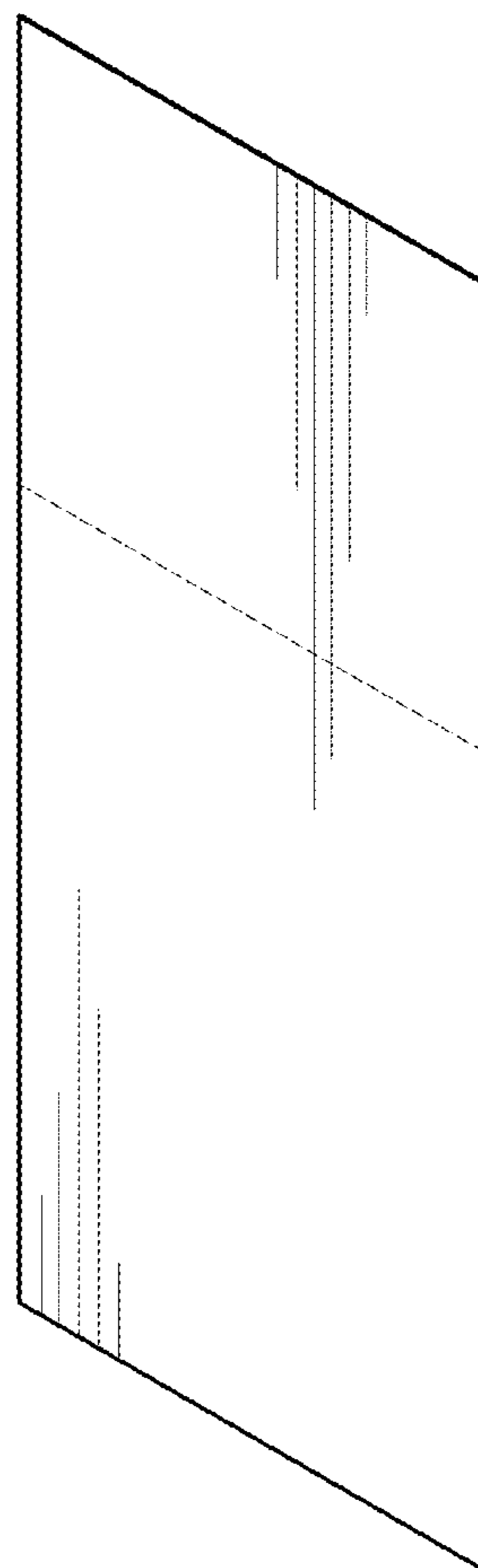
U.S. PATENT DOCUMENTS

|              |    |   |         |      |       |                       |
|--------------|----|---|---------|------|-------|-----------------------|
| D667,494     | S  | * | 9/2012  | Sato | ..... | D19/1                 |
| D679,753     | S  |   | 4/2013  | Sato |       |                       |
| D680,166     | S  |   | 4/2013  | Sato |       |                       |
| D681,110     | S  |   | 4/2013  | Sato |       |                       |
| D681,111     | S  |   | 4/2013  | Sato |       |                       |
| D690,351     | S  |   | 9/2013  | Sato |       |                       |
| 2001/0031331 | A1 | * | 10/2001 | Kuo  | ..... | B32B 7/06<br>428/40.1 |

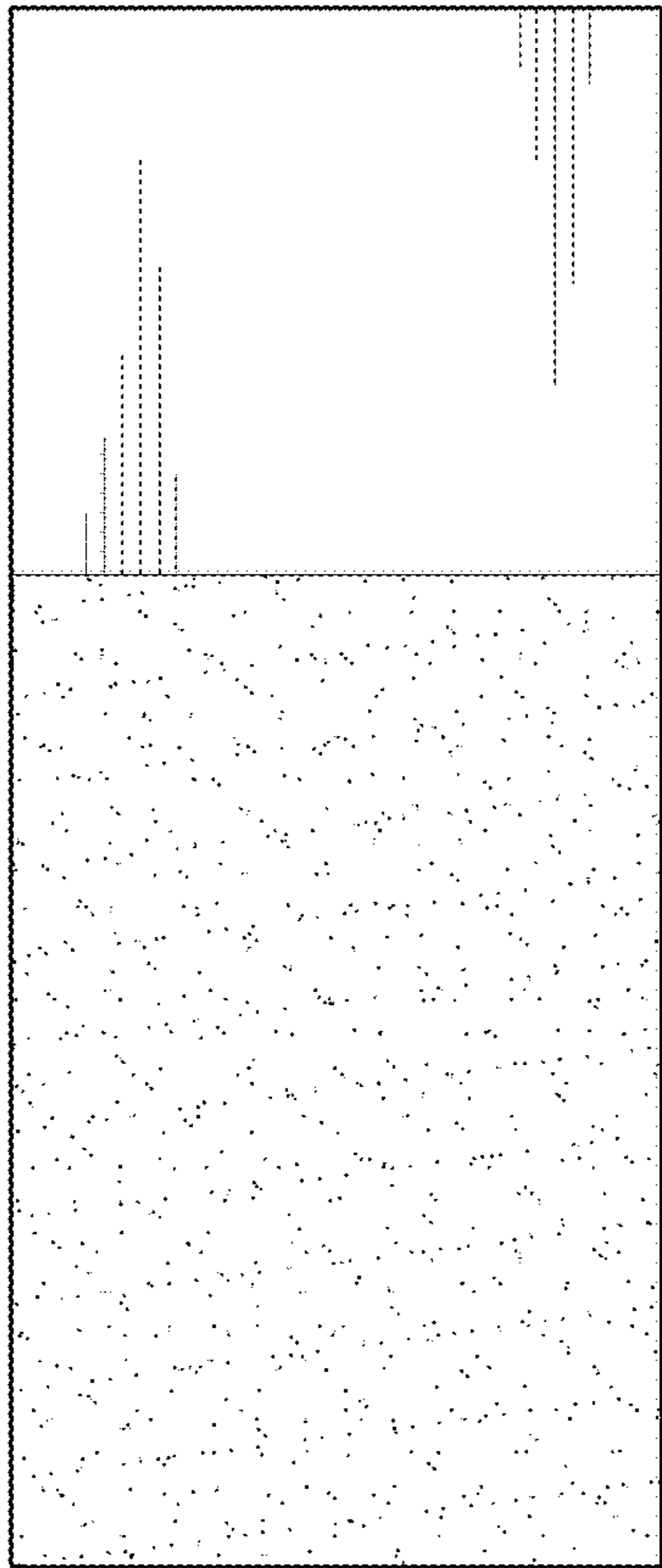
\* cited by examiner



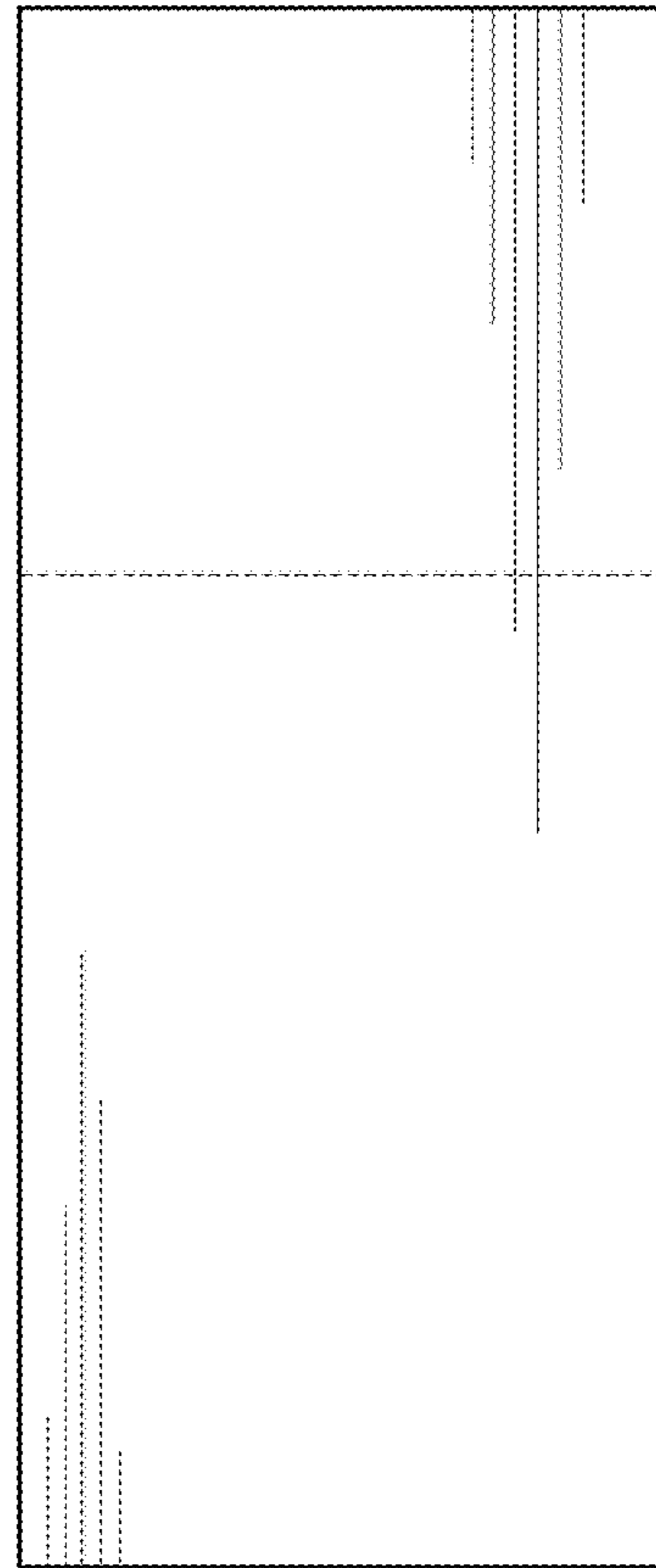
*Fig. 1*



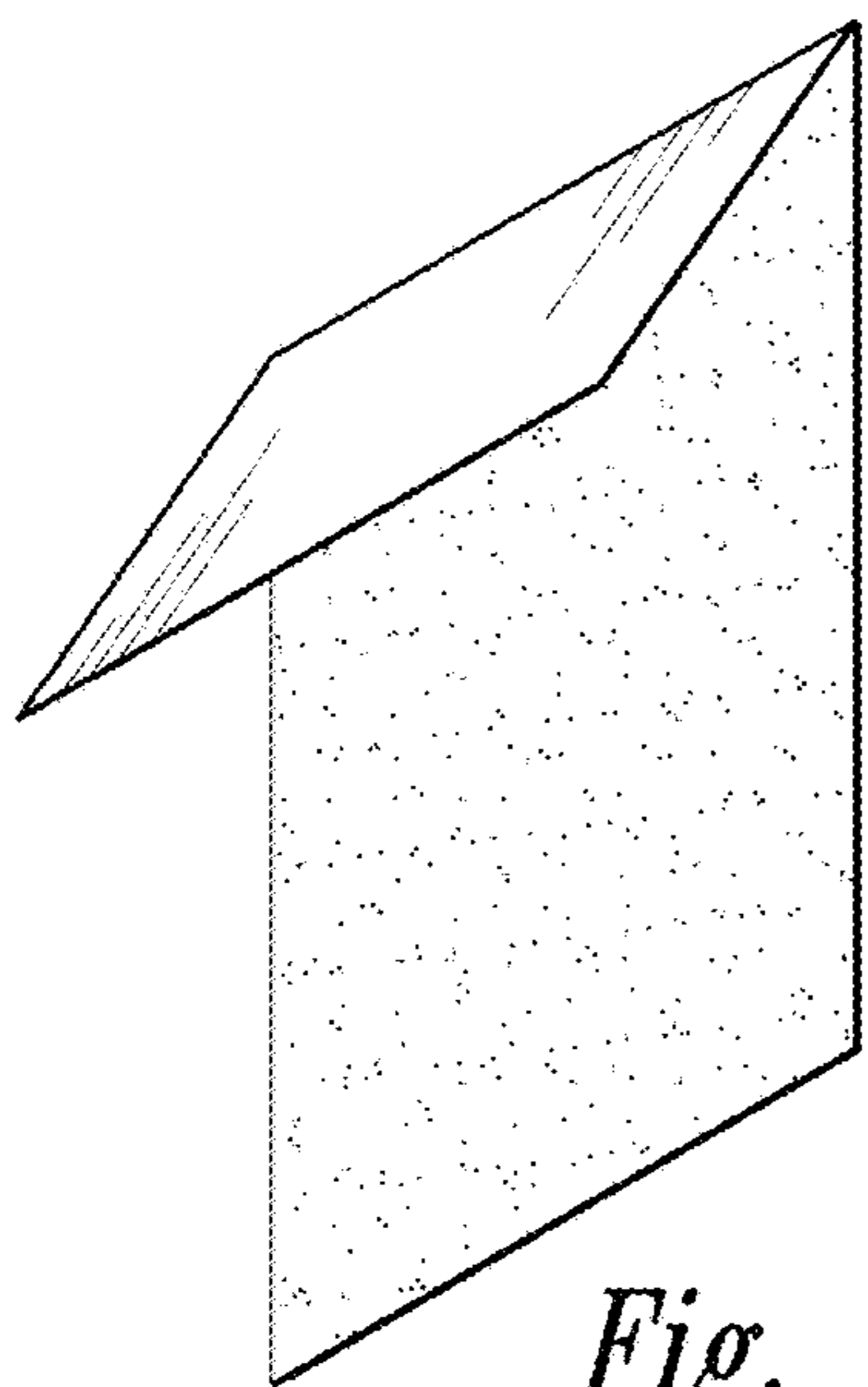
*Fig. 2*



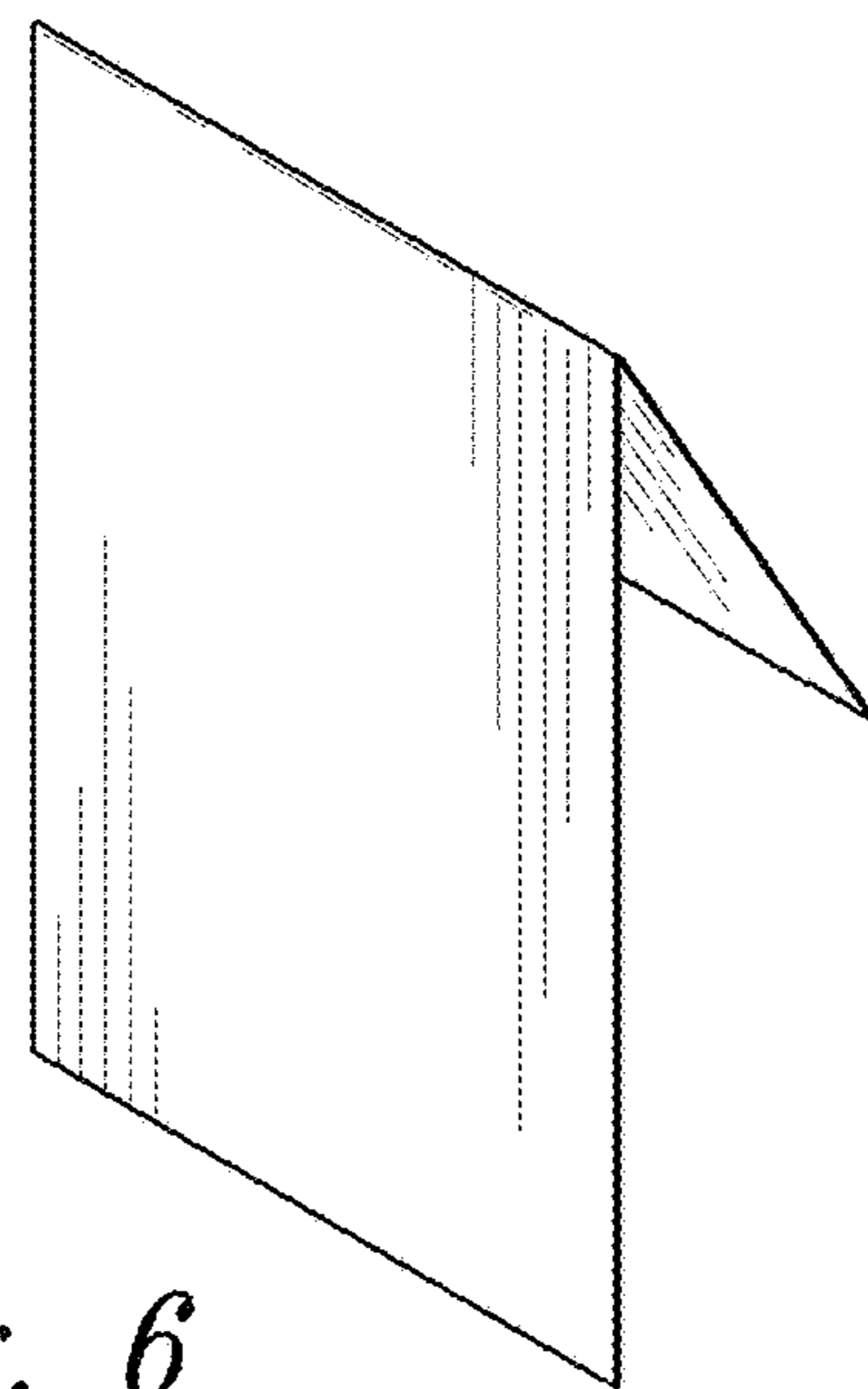
*Fig. 3*



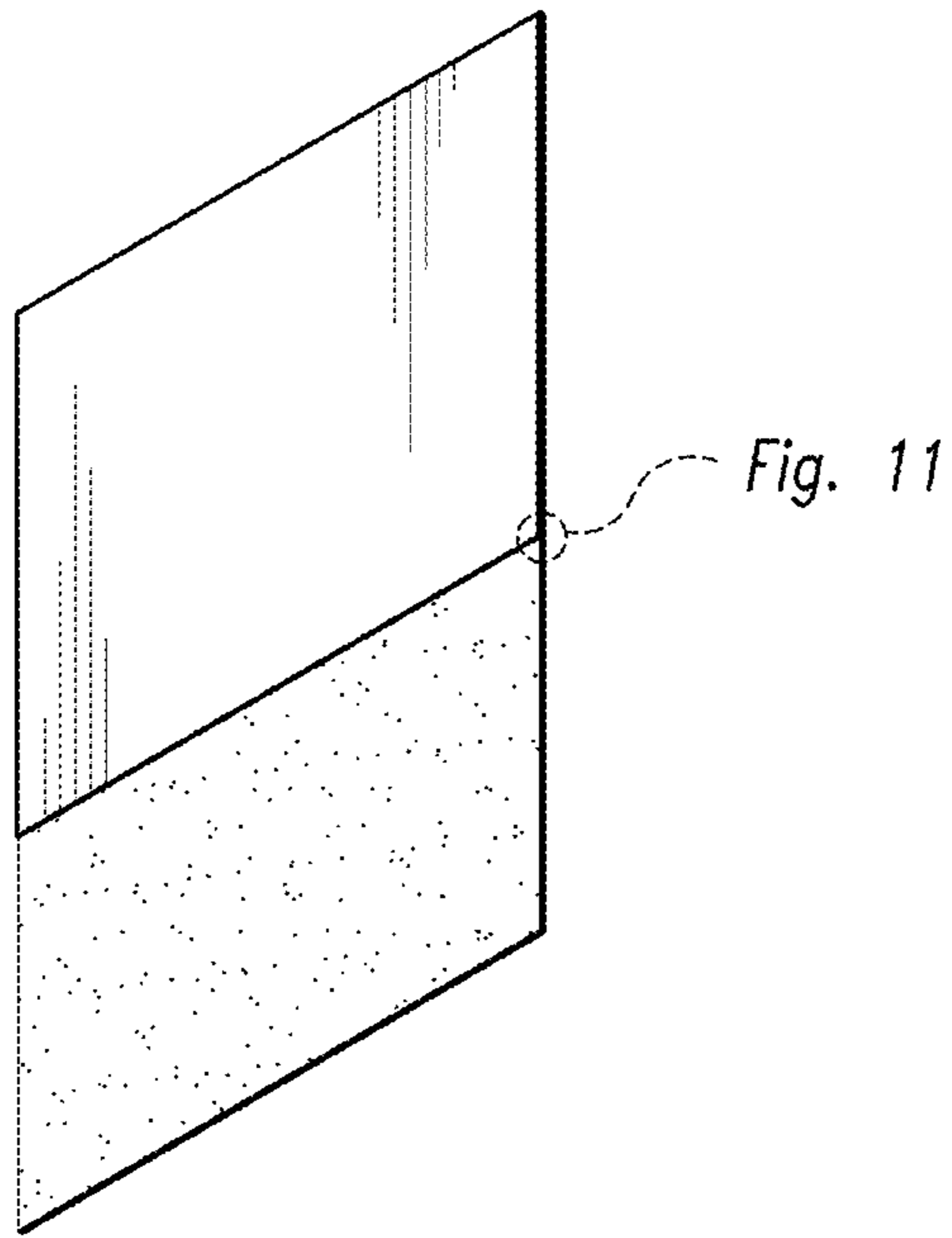
*Fig. 4*



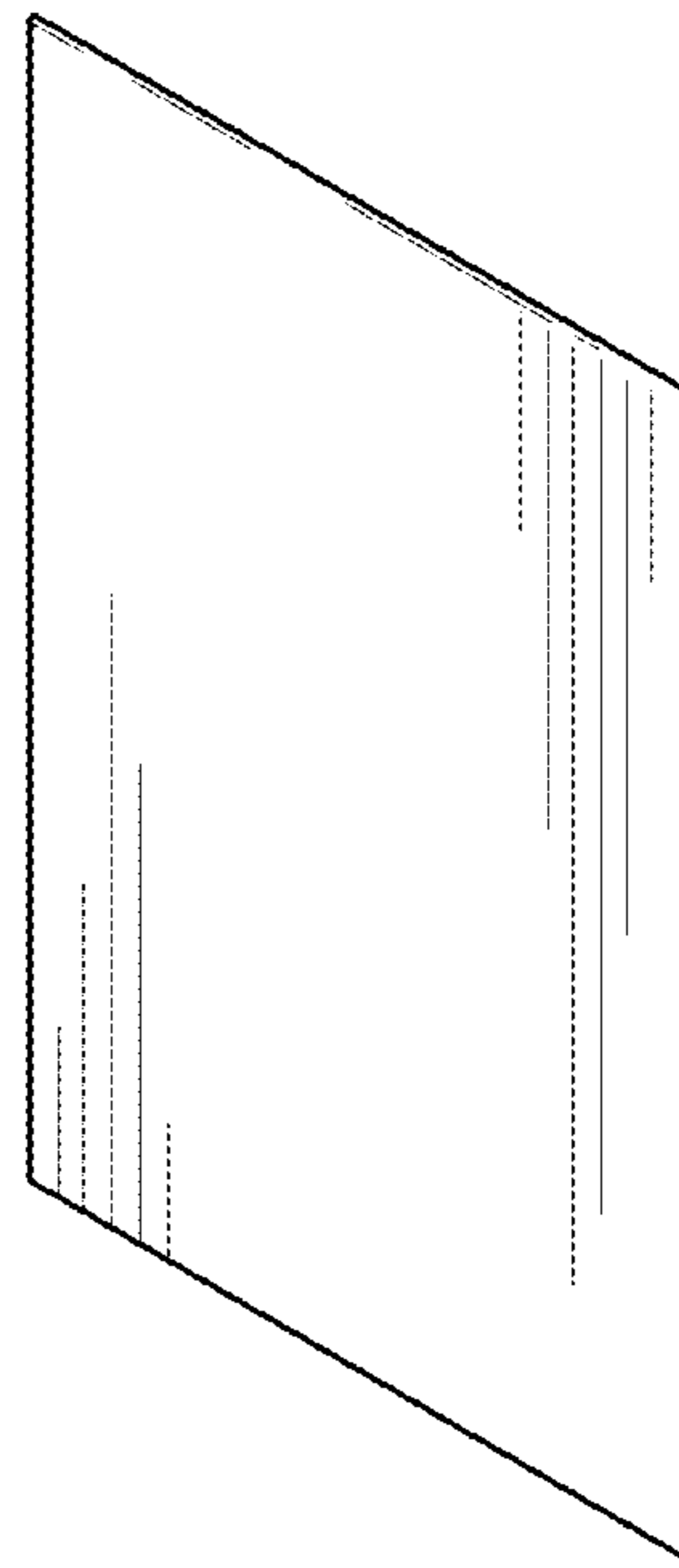
*Fig. 5*



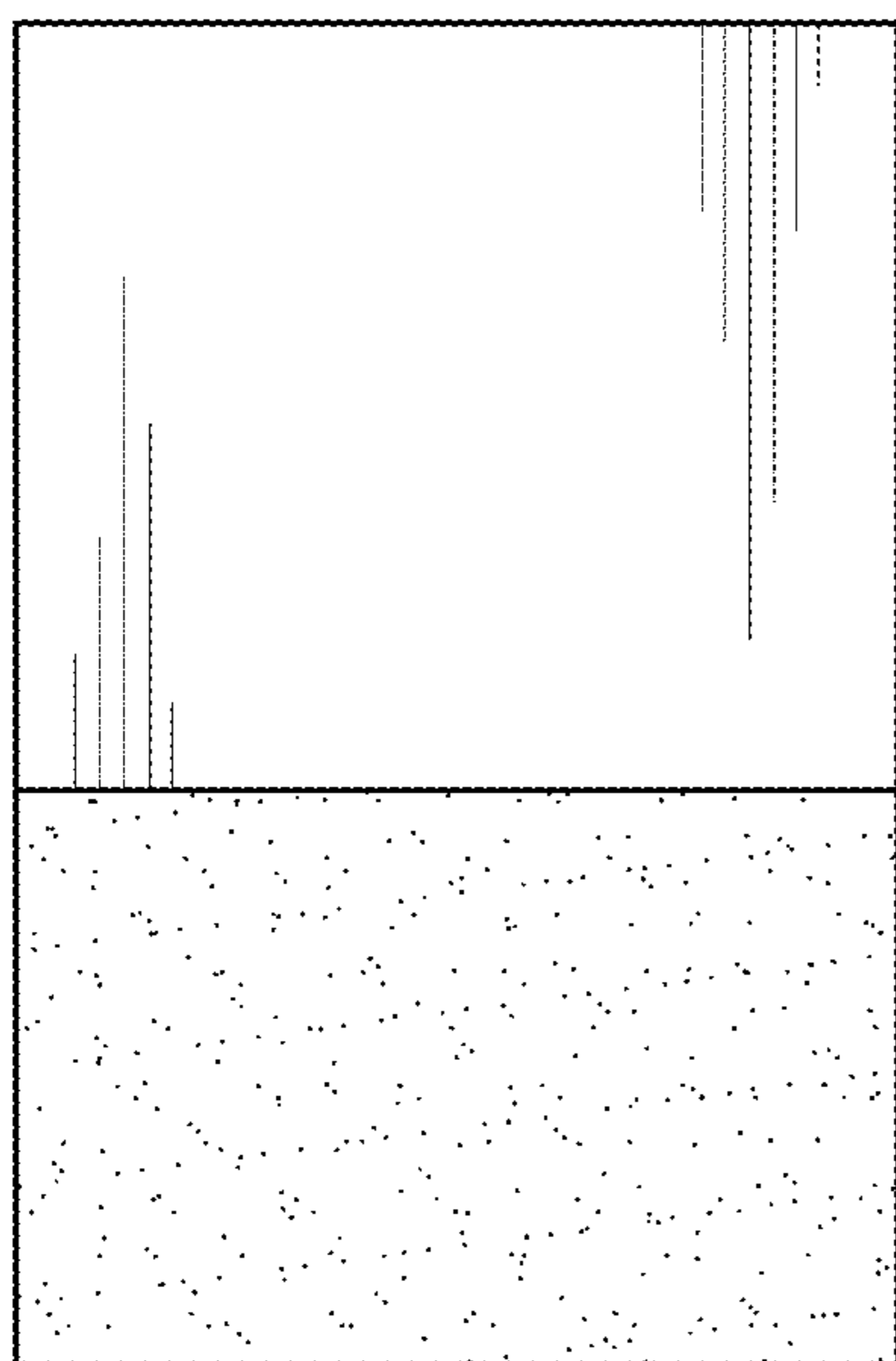
*Fig. 6*



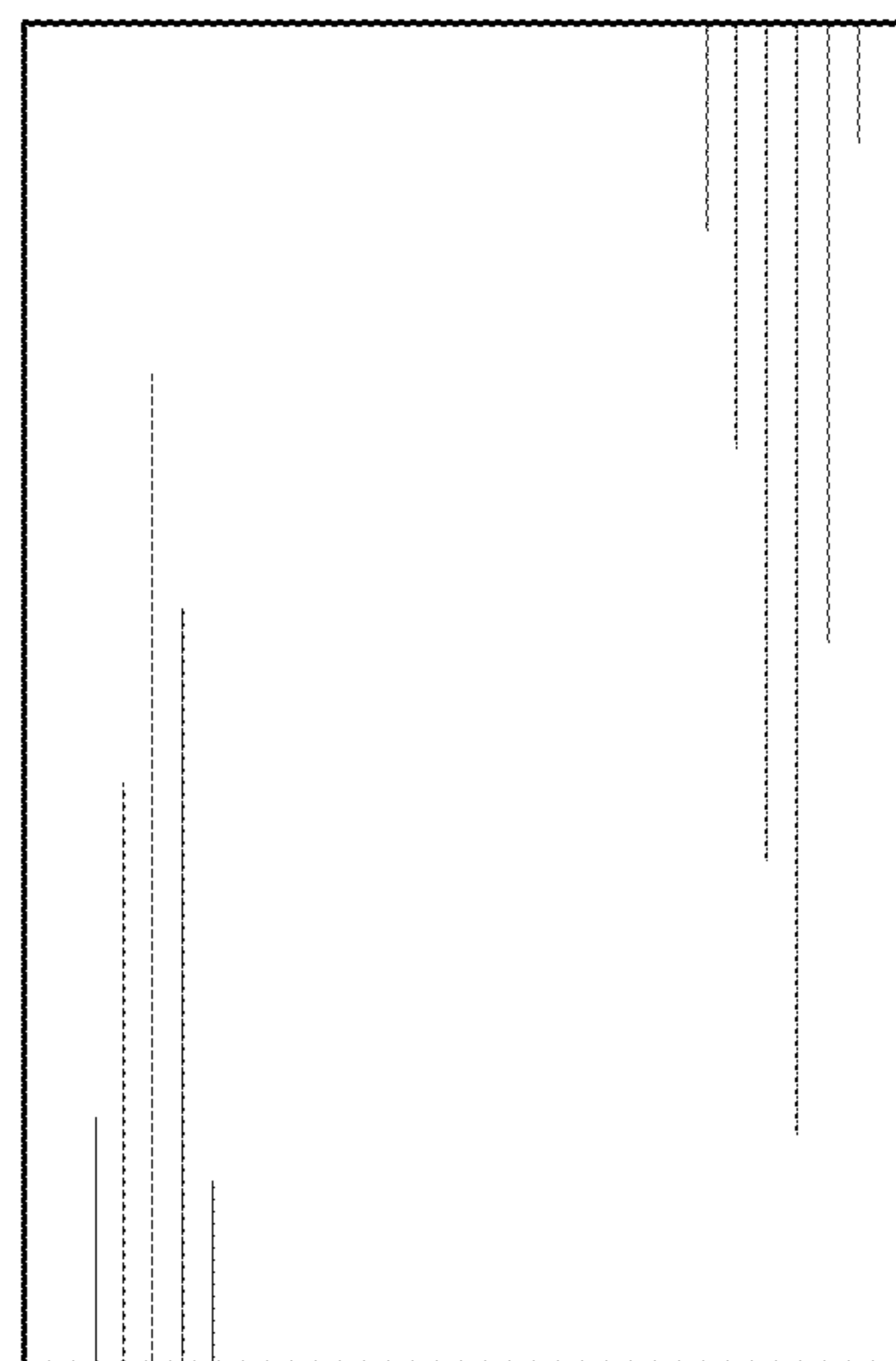
*Fig. 7*



*Fig. 8*

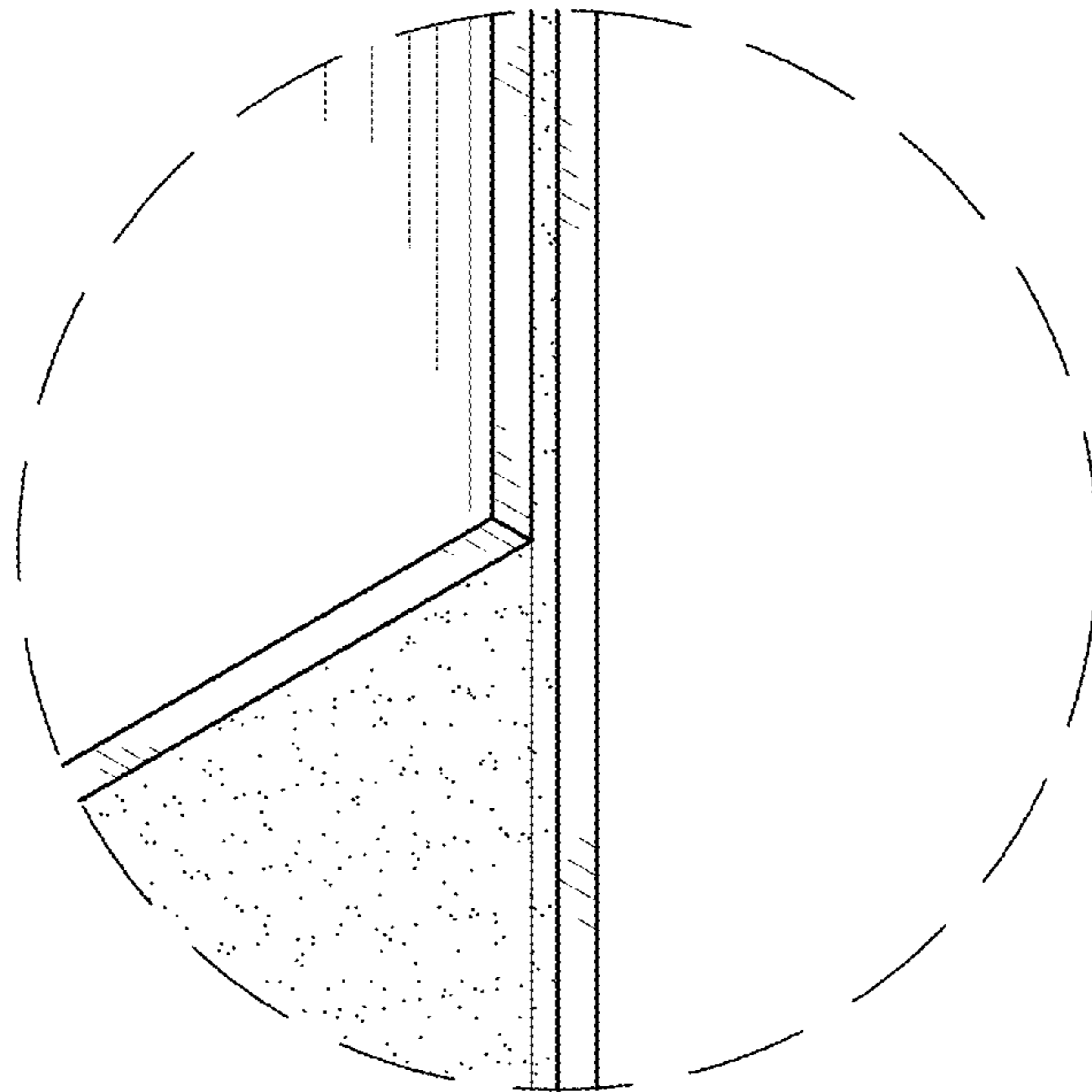


*Fig. 9*

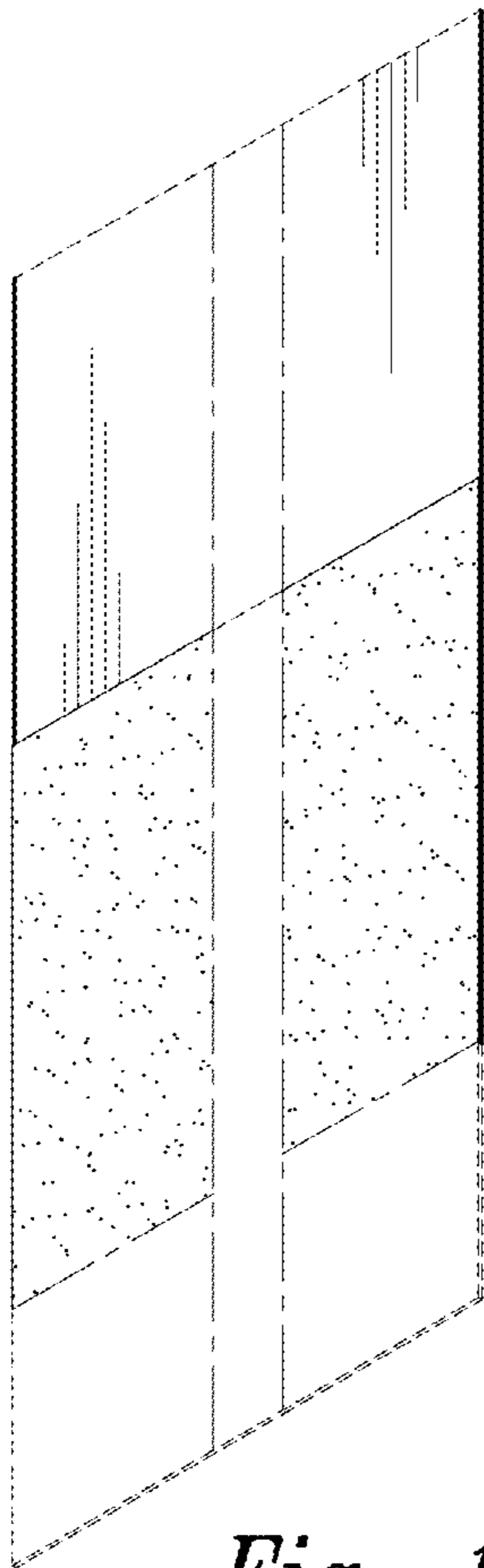


*Fig. 10*

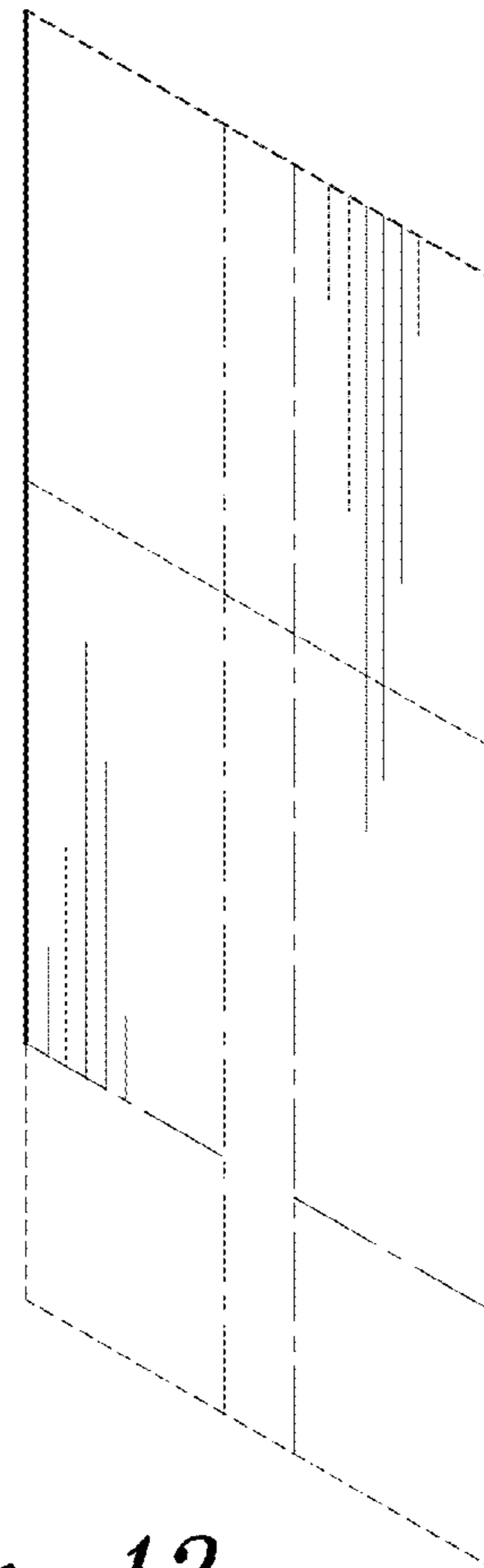




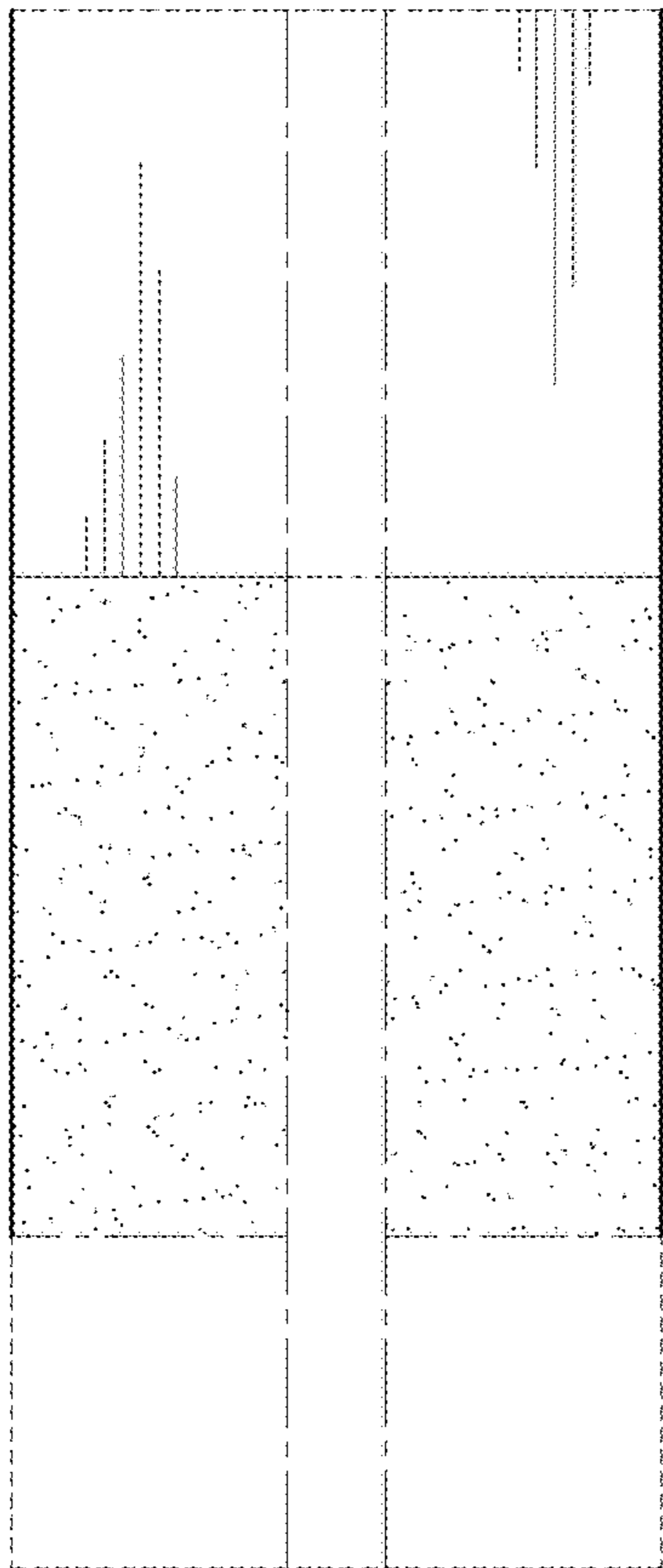
*Fig. 11*



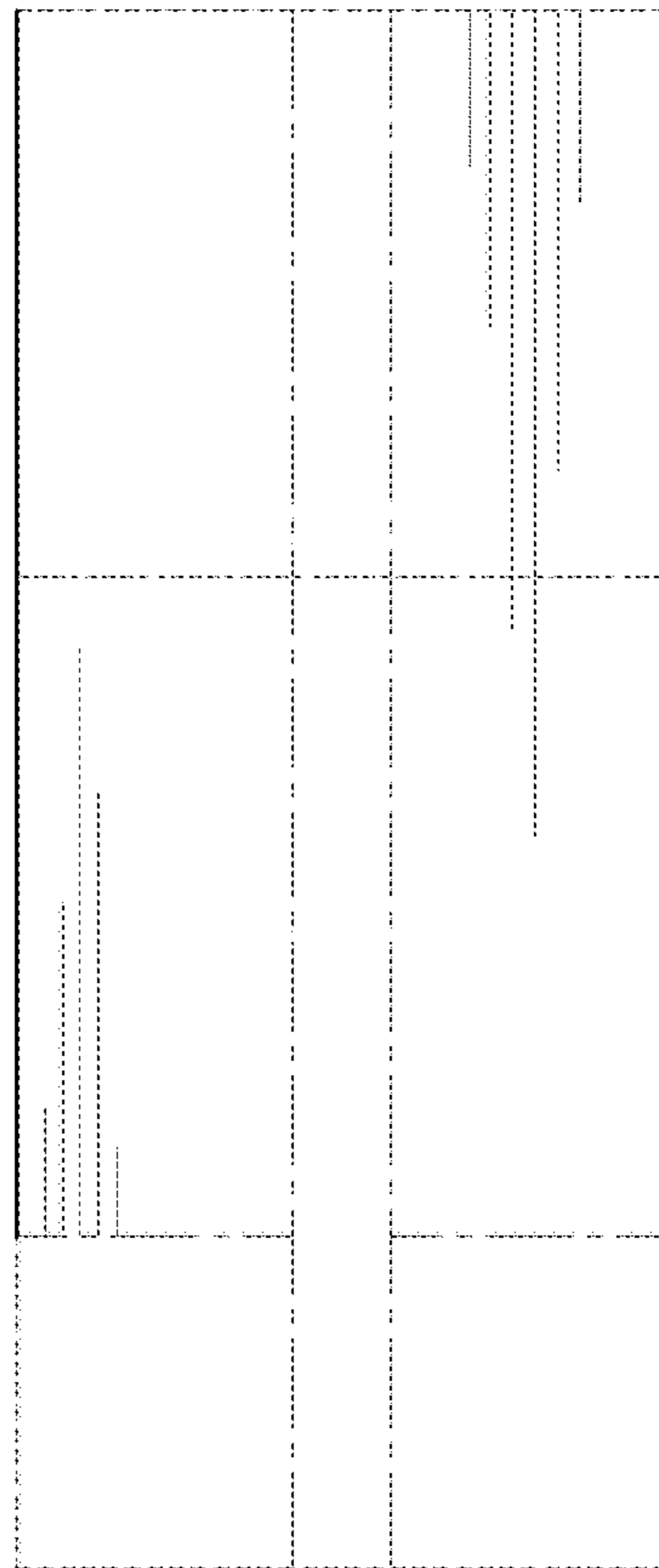
*Fig. 12*



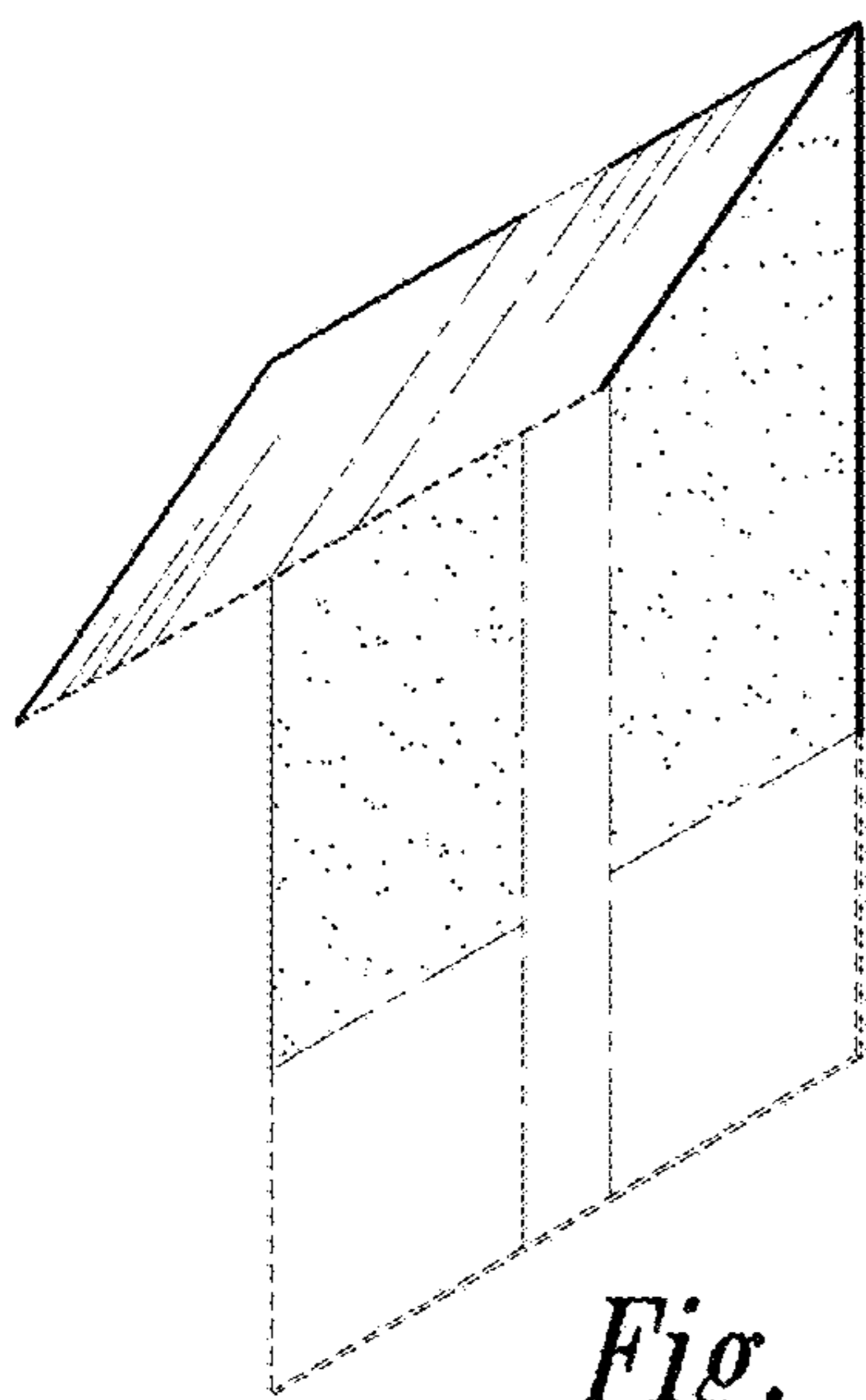
*Fig. 13*



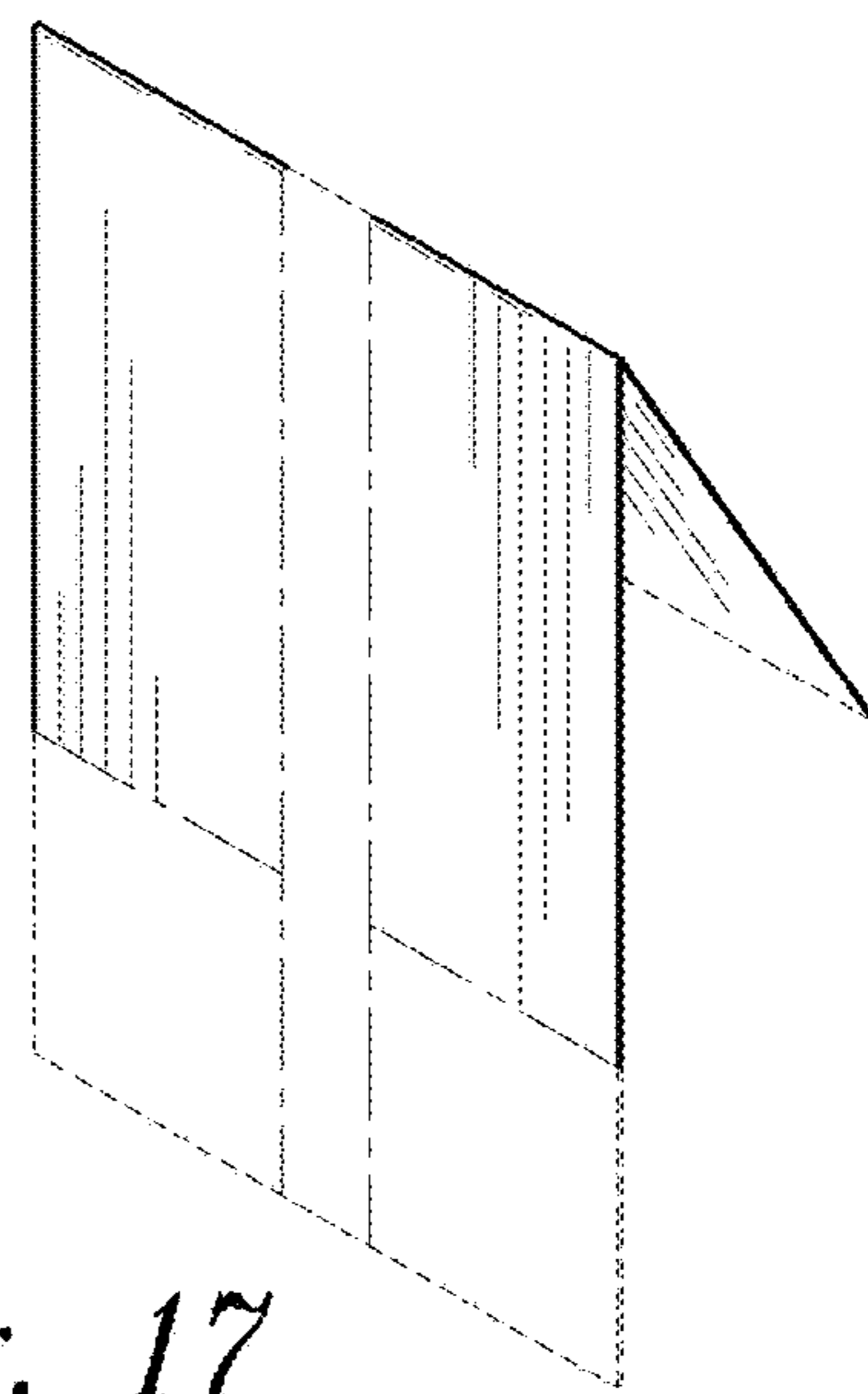
*Fig. 14*



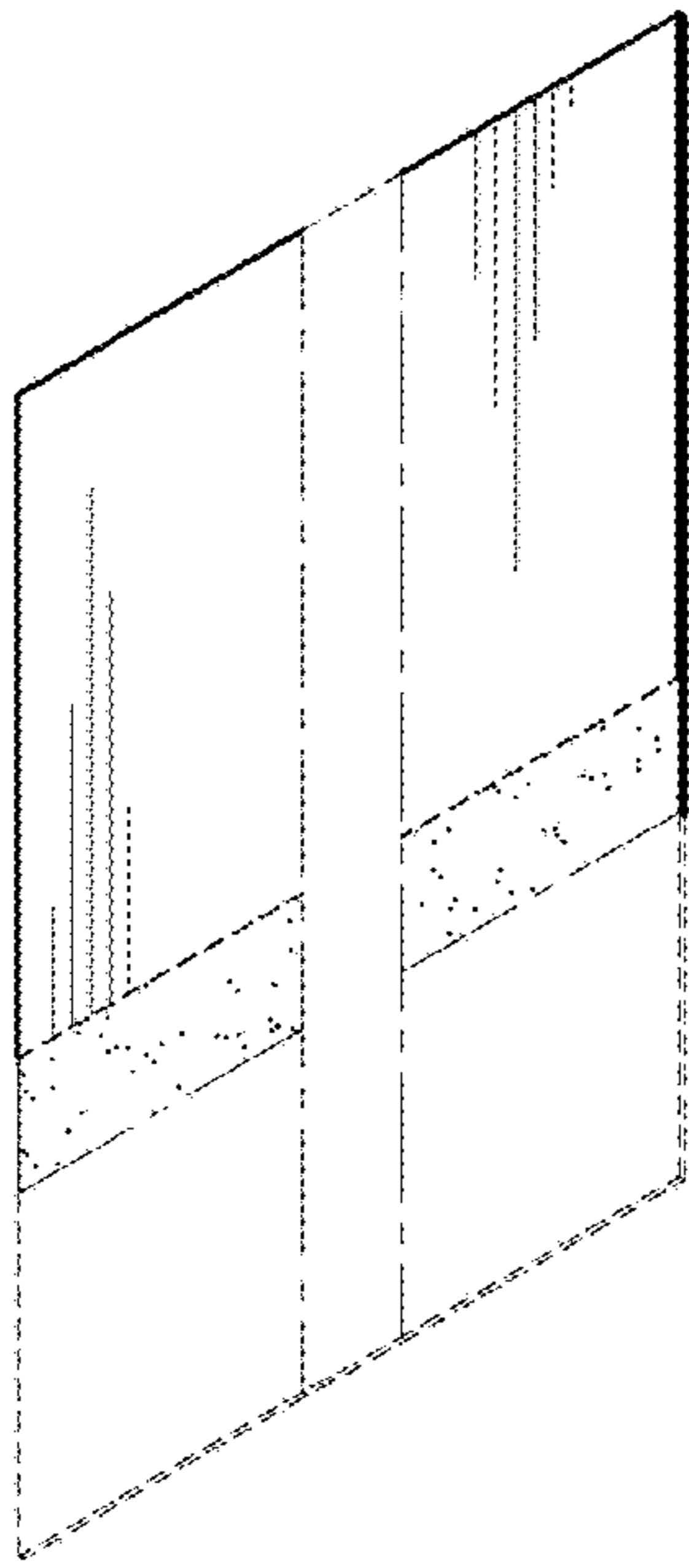
*Fig. 15*



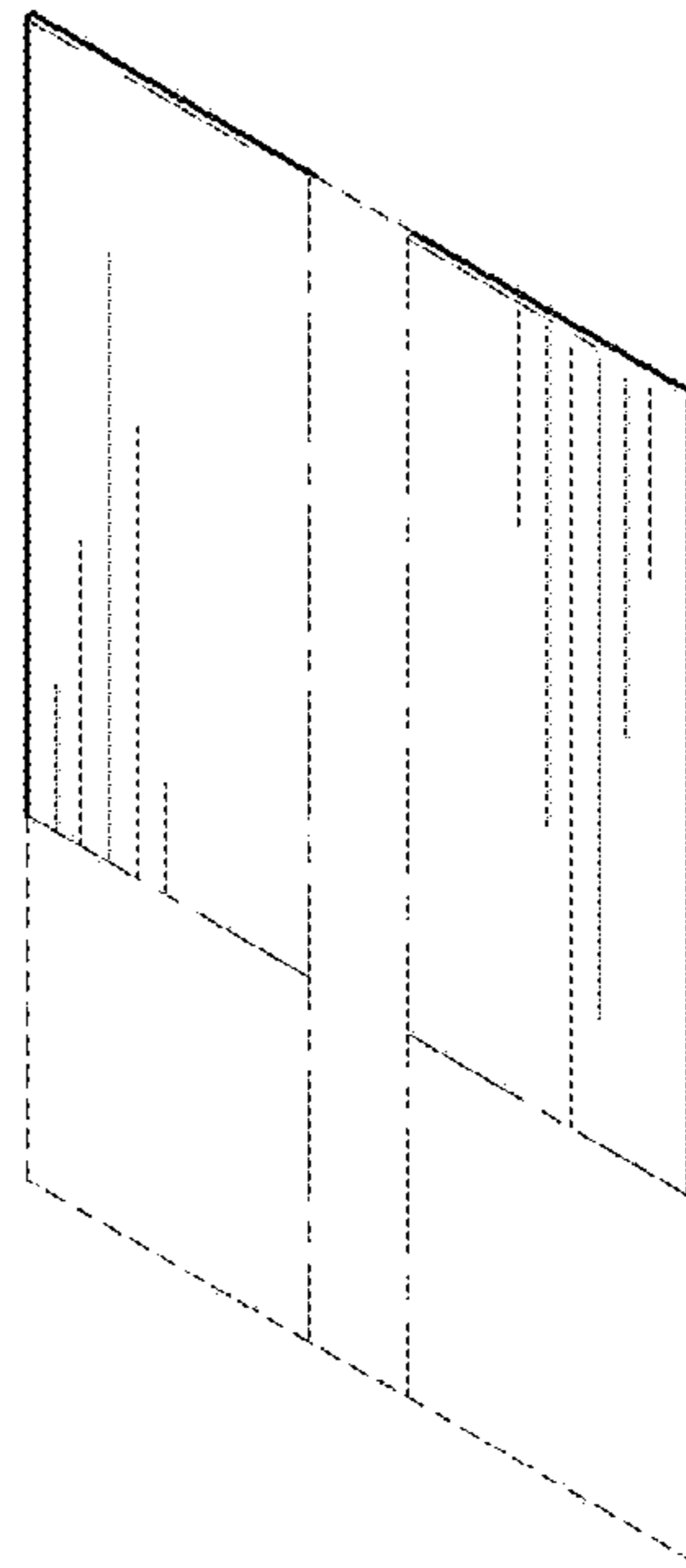
*Fig. 16*



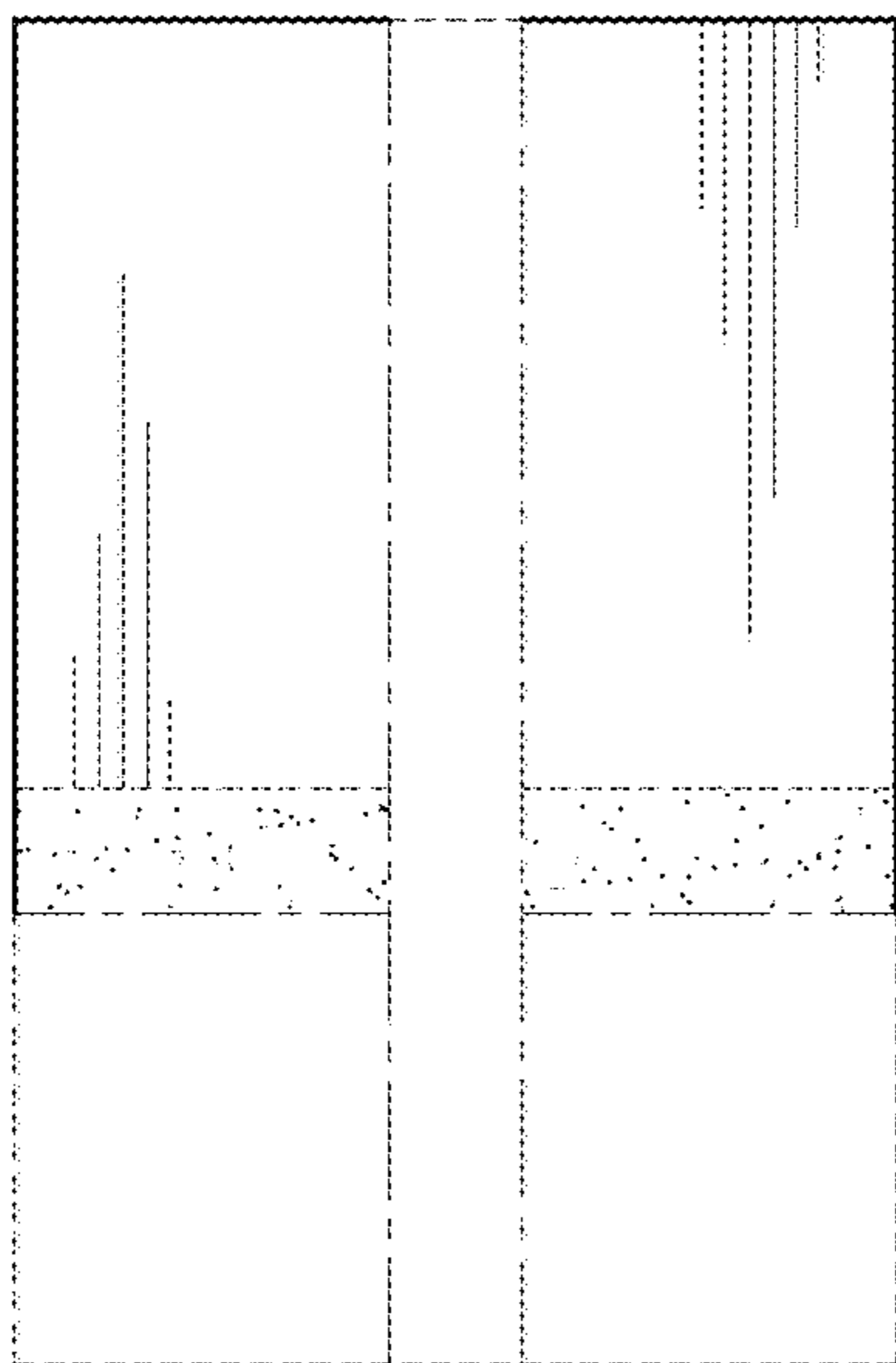
*Fig. 17*



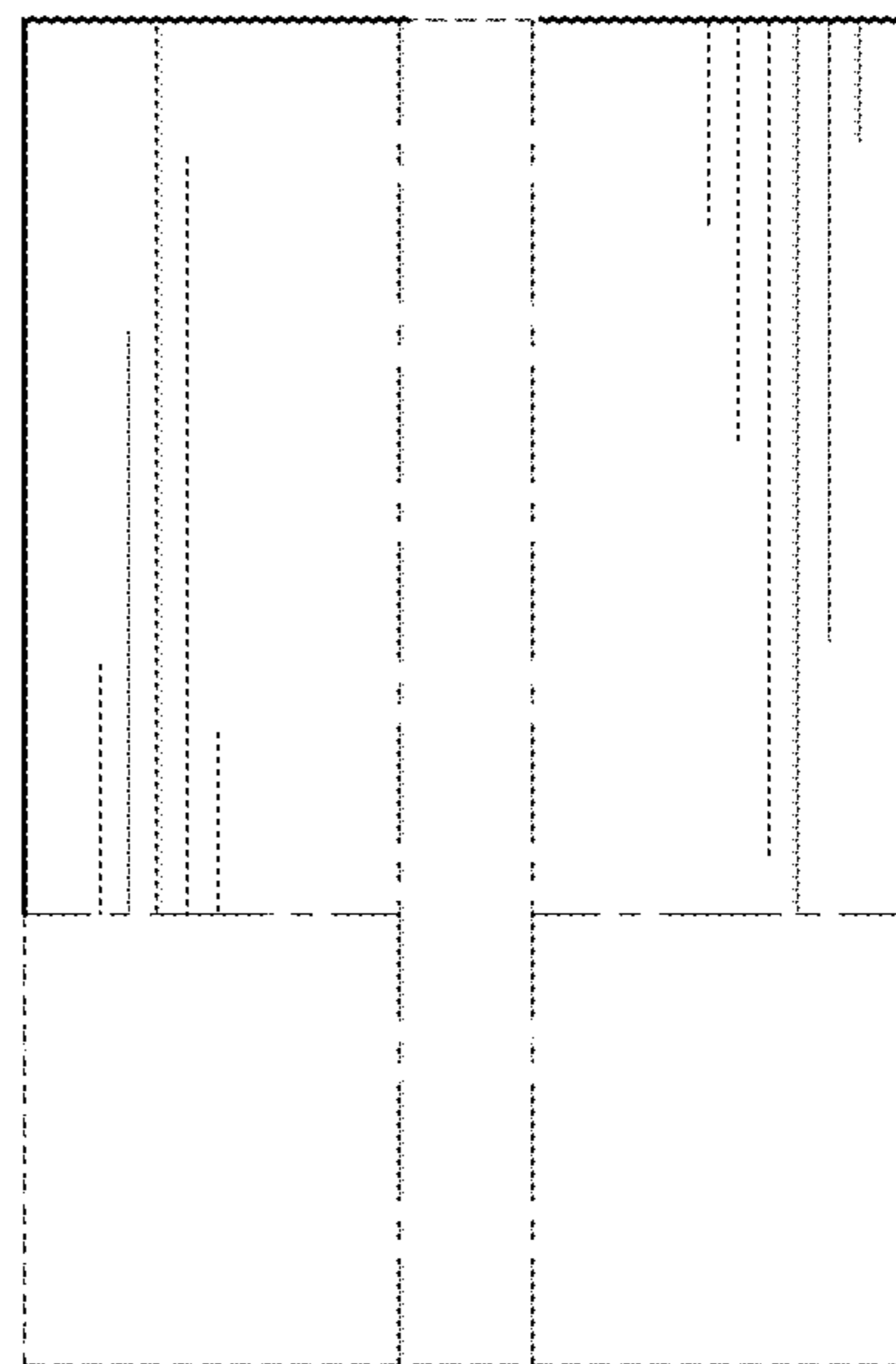
*Fig. 18*



*Fig. 19*

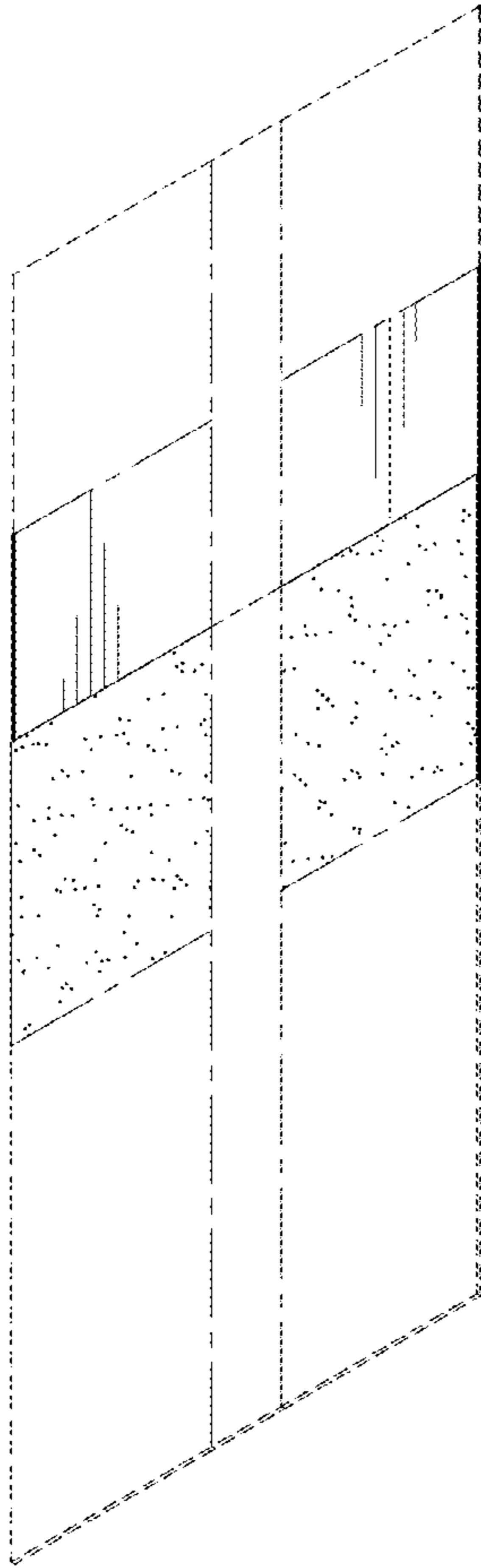


*Fig. 20*

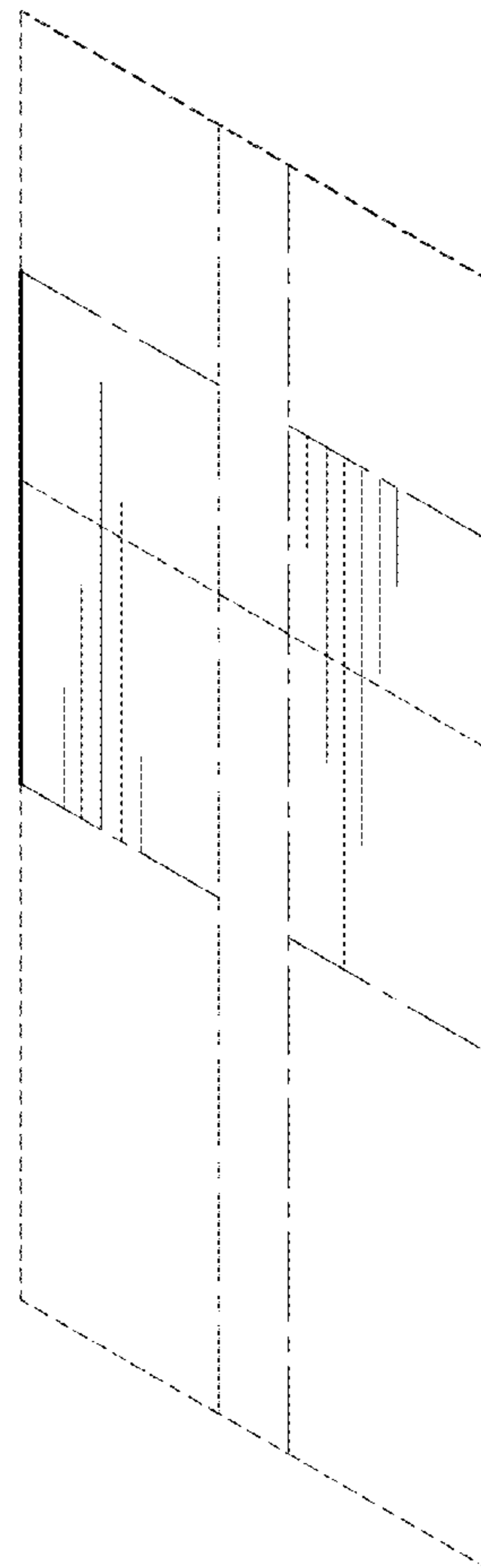


*Fig. 21*

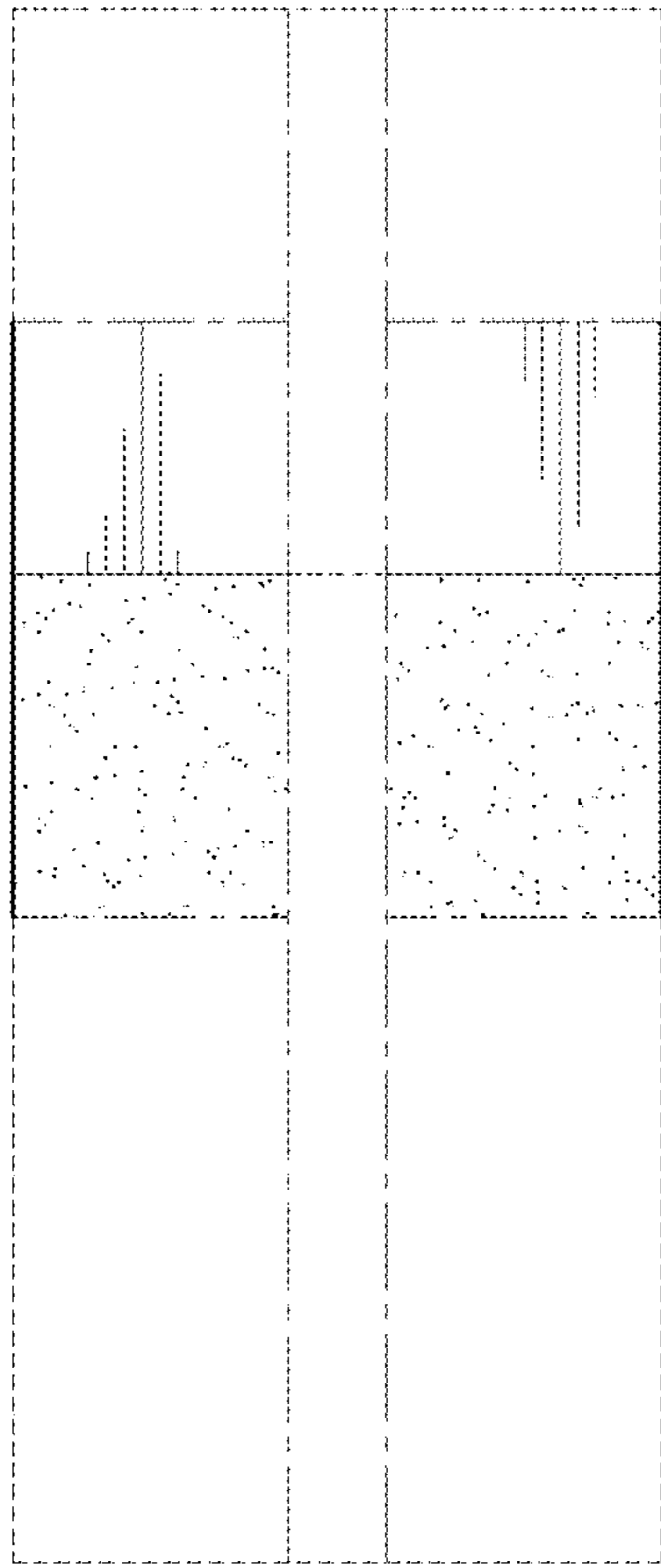




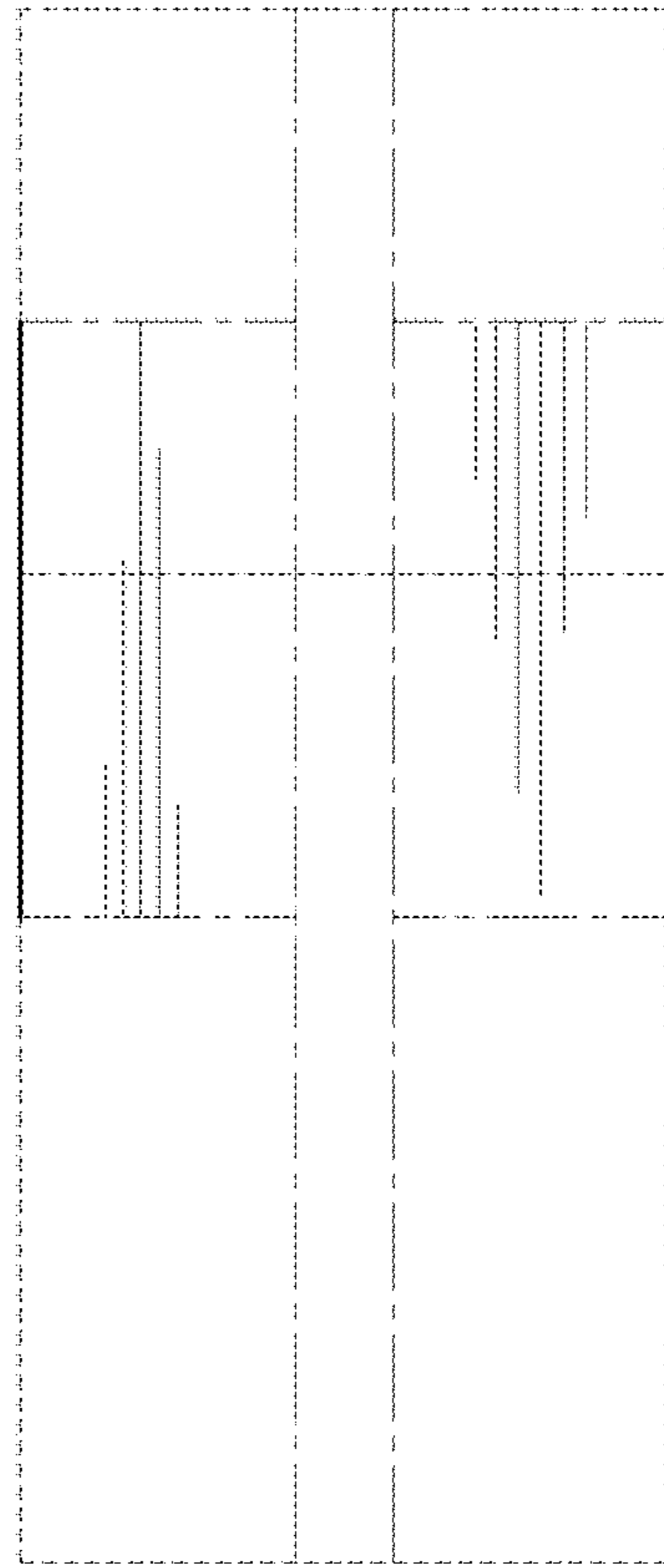
*Fig. 22*



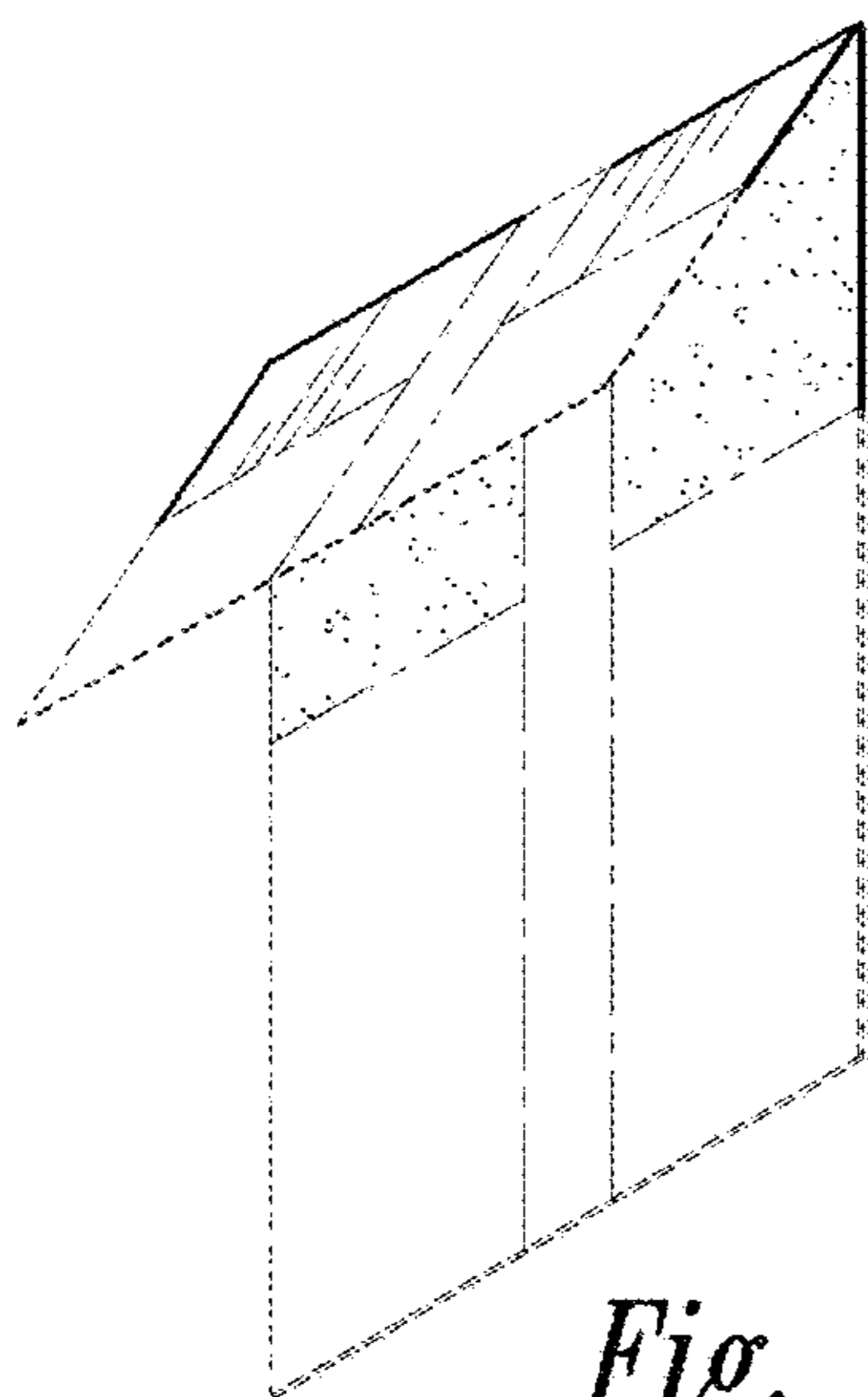
*Fig. 23*



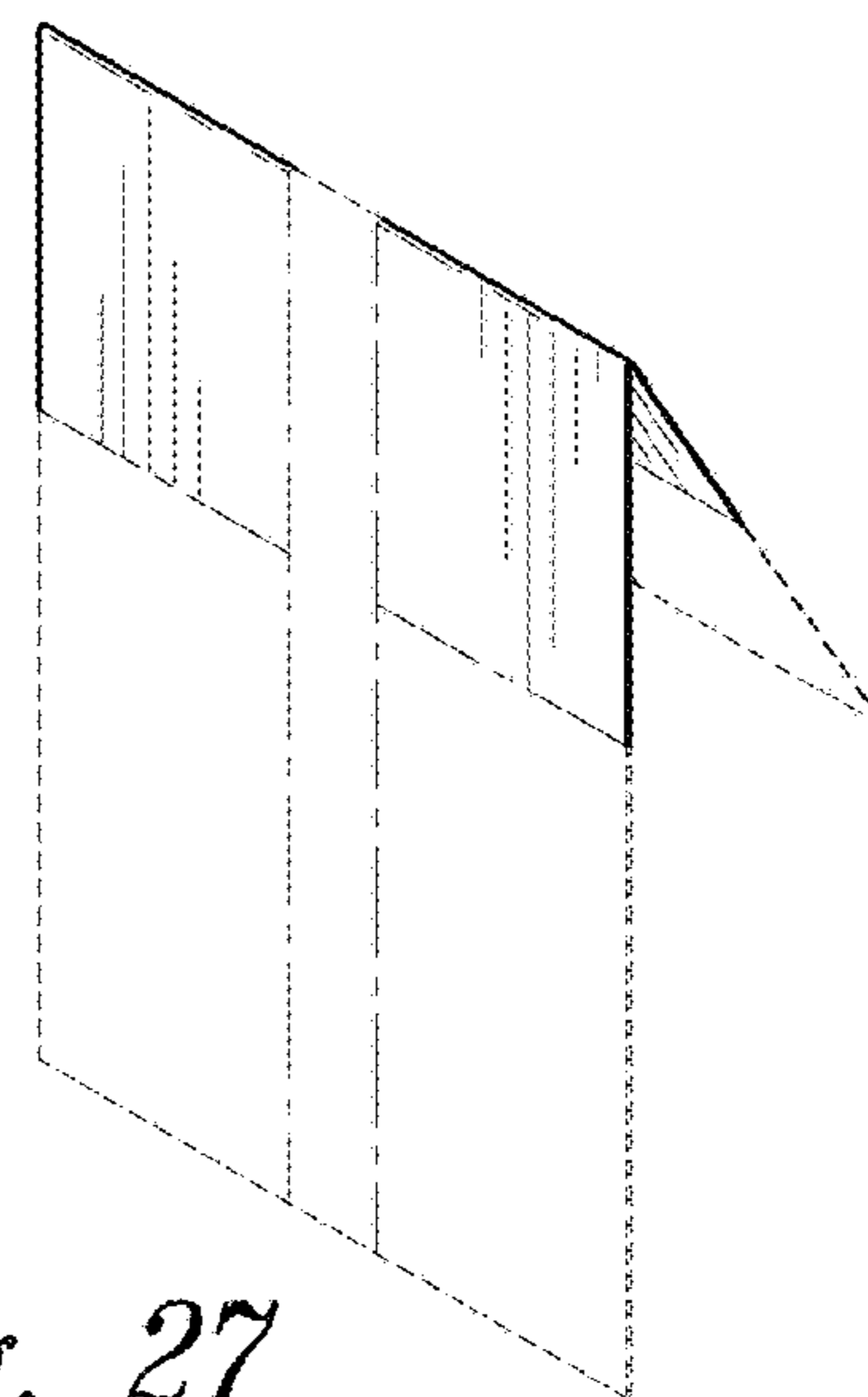
*Fig. 24*



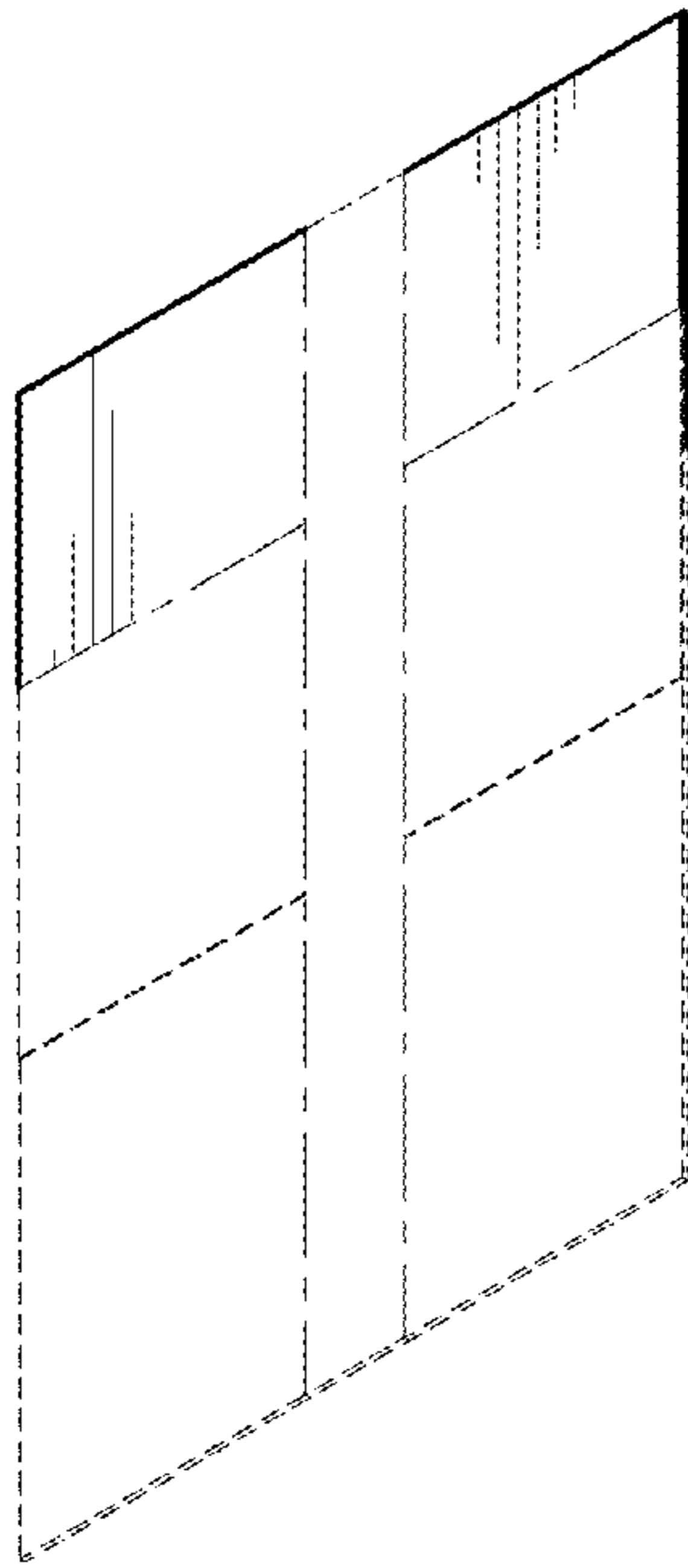
*Fig. 25*



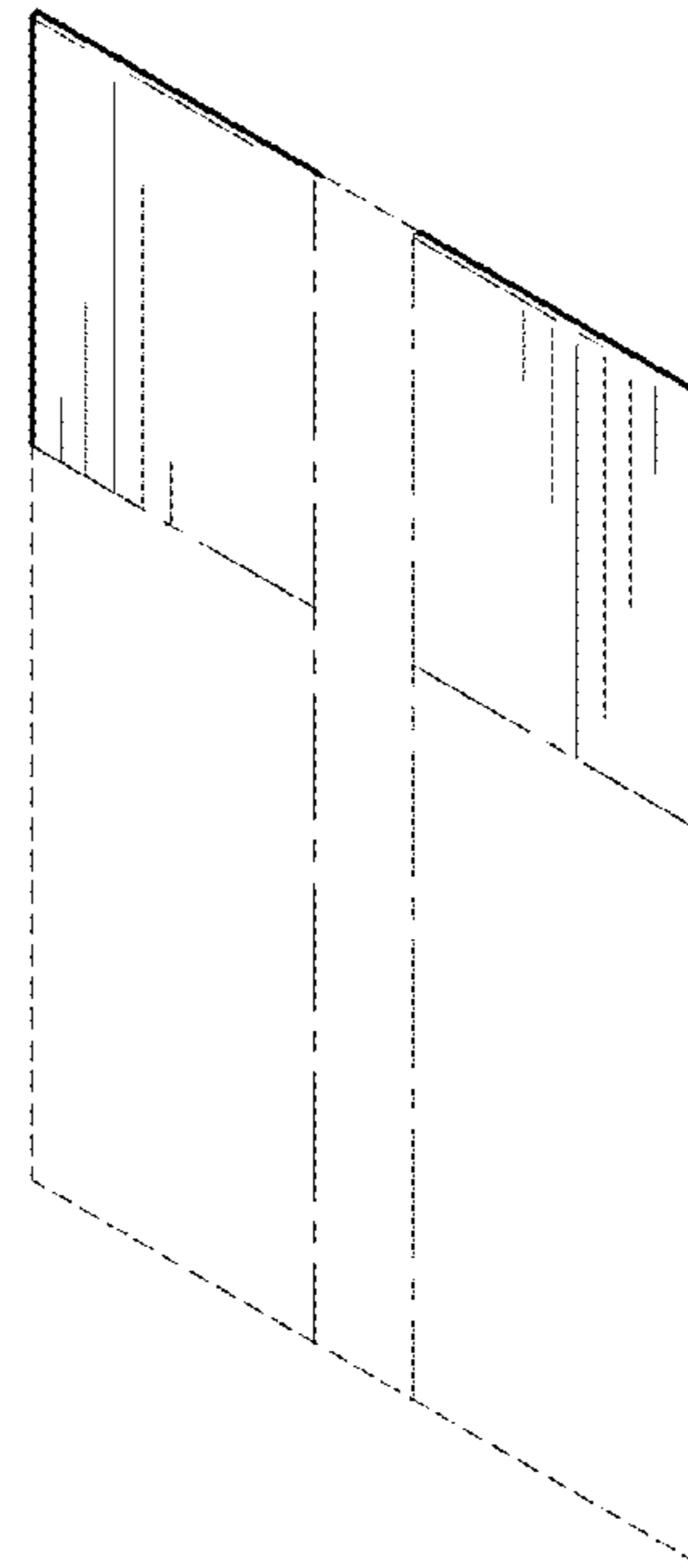
*Fig. 26*



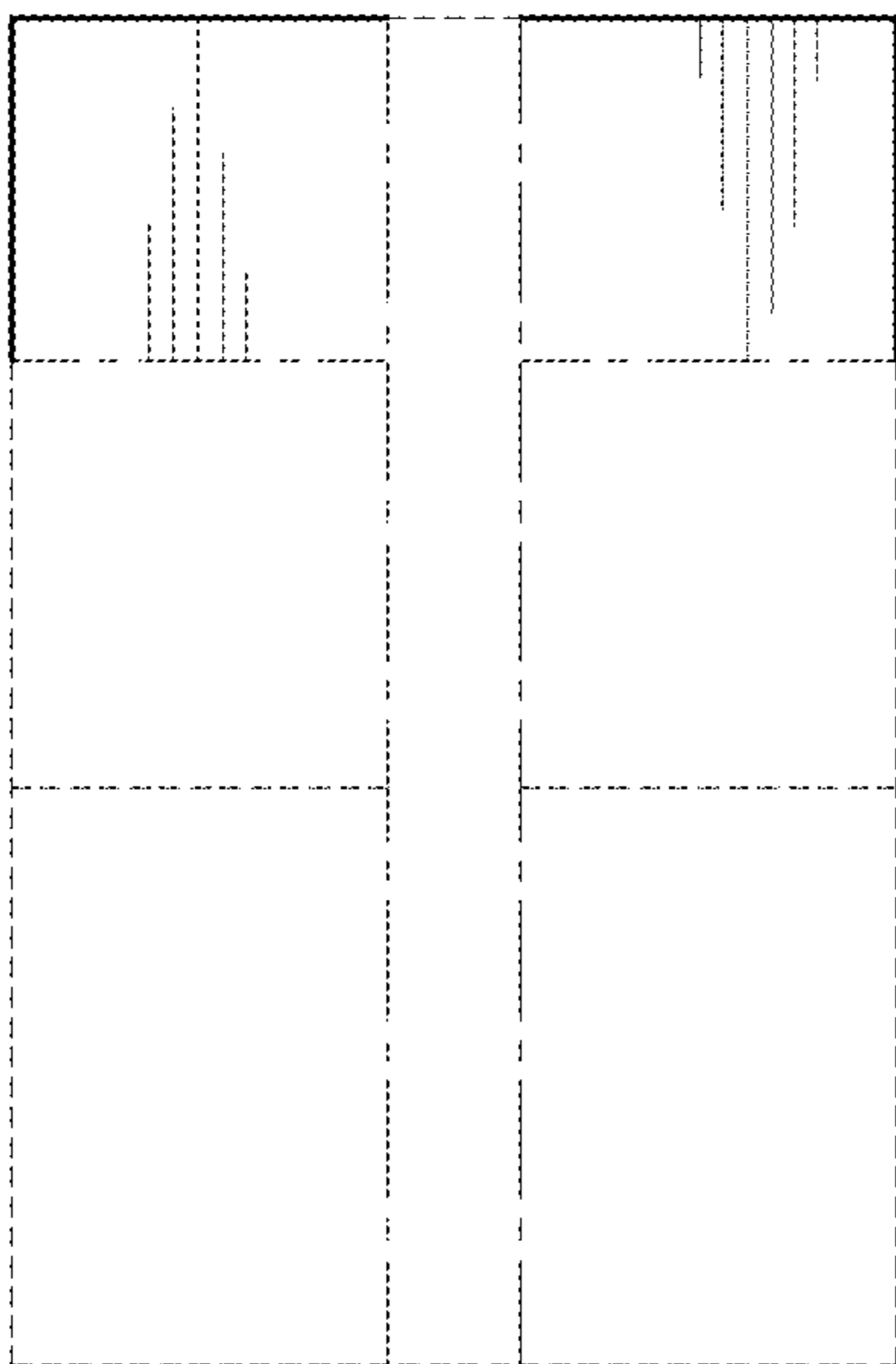
*Fig. 27*



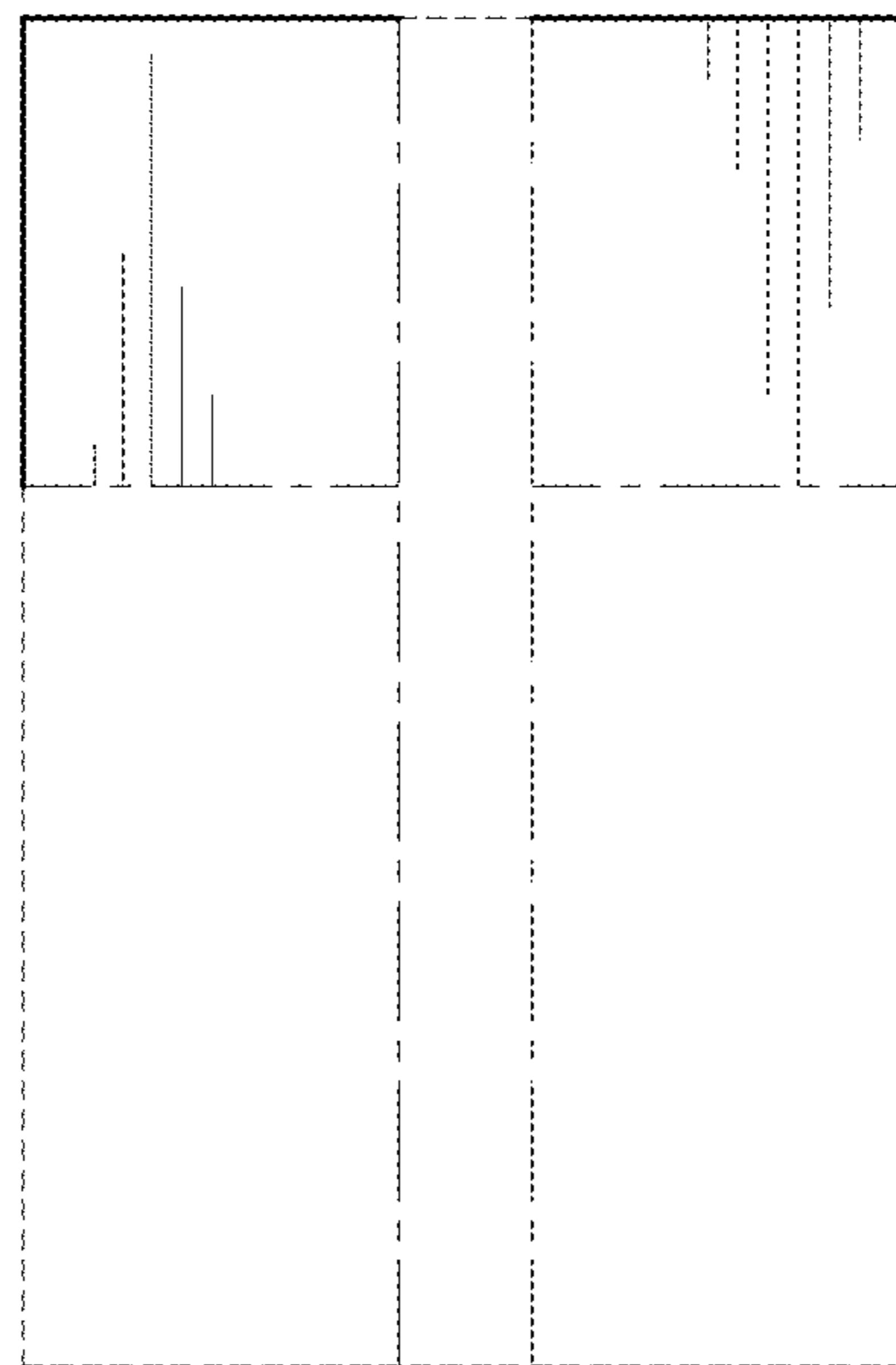
*Fig. 28*



*Fig. 29*



*Fig. 30*



*Fig. 31*