



US00D779455S

(12) **United States Design Patent** (10) **Patent No.:** **US D779,455 S**
Balcerzak et al. (45) **Date of Patent:** **** Feb. 21, 2017**

(54) **COMBINATION SPEAKER/WIRELESS PHONE CHARGER**

6,973,179 B1 * 12/2005 Kaufman H04M 1/6033
379/387.01
D579,441 S * 10/2008 Okamura D14/168
D587,675 S * 3/2009 Xie D14/168
D598,005 S * 8/2009 Amano D14/209.1
(Continued)

(71) Applicant: **Sproutbox Design Limited**, Vancouver (CA)

(72) Inventors: **Martin Balcerzak**, Burnaby (CA);
Mladen Jovicic, Vancouver (CA)

(73) Assignee: **Sproutbox Design Limited**, Vancouver, British Columbia (CA)

(**) Term: **15 Years**

(21) Appl. No.: **29/543,736**

(22) Filed: **Oct. 27, 2015**

(51) **LOC (10) Cl.** **14-01**

(52) **U.S. Cl.**
USPC **D14/172; D14/215; D14/203.6**

(58) **Field of Classification Search**
USPC D14/204, 218, 172, 210–216, 209.1, 496,
D14/497, 137, 168, 181, 185, 188,
D14/299, 203.1–203.8, 221; 181/143,
181/147, 148, 150, 153, 157, 198, 199,
181/166, 144; 381/300–303, 306, 332,
381/333, 336, 345, 361–364, 370,
381/386–388; 455/344–351; 84/609–614,
84/634–638; 434/307 A, 307 R, 434/309,
434/318; 352/1, 6–10
CPC H04R 1/02; H04R 1/023; H04R 1/026;
H04R 1/30; H04R 3/00; H04R
9/06; H04R 11/02; H04R 19/02; H04M
1/6033; H04M 1/6041; H04M
9/00; H04M 3/567

See application file for complete search history.

(56) **References Cited**

U.S. PATENT DOCUMENTS

2,718,563 A * 9/1955 Nicholides H04R 1/08
381/162
5,546,468 A * 8/1996 Beard B60R 11/0217
181/145

OTHER PUBLICATIONS

Author: Streams OS; Title: www.glowdeck.com; Date: Oct. 26, 2015 (or earlier); Pages: homepage.
(Continued)

Primary Examiner — Prabhakar Deshmukh
(74) *Attorney, Agent, or Firm* — DWC Law Firm, P.S.;
David Chen

(57) **CLAIM**

The ornamental design for a combination speaker/wireless phone charger, as shown and described.

DESCRIPTION

FIG. 1 is a top isometric view of a combination speaker/wireless phone charger showing our new design.
FIG. 2 is a bottom isometric view thereof.
FIG. 3 is a front side elevation view thereof.
FIG. 4 is a back side elevation view thereof.
FIG. 5 is a left side elevation view thereof.
FIG. 6 is a right side elevation view thereof.
FIG. 7 is a top plan view thereof.
FIG. 8 is a bottom plan view thereof.
FIG. 9 is a top isometric view of an alternative embodiment of a combination speaker/wireless phone charger showing our new design.
FIG. 10 is a bottom isometric view thereof.
FIG. 11 is a front side elevation view thereof.
FIG. 12 is a back side elevation view thereof.
FIG. 13 is a left side elevation view thereof.
FIG. 14 is a right side elevation view thereof.
FIG. 15 is a top plan view thereof; and,
FIG. 16 is a bottom plan view thereof.

(Continued)

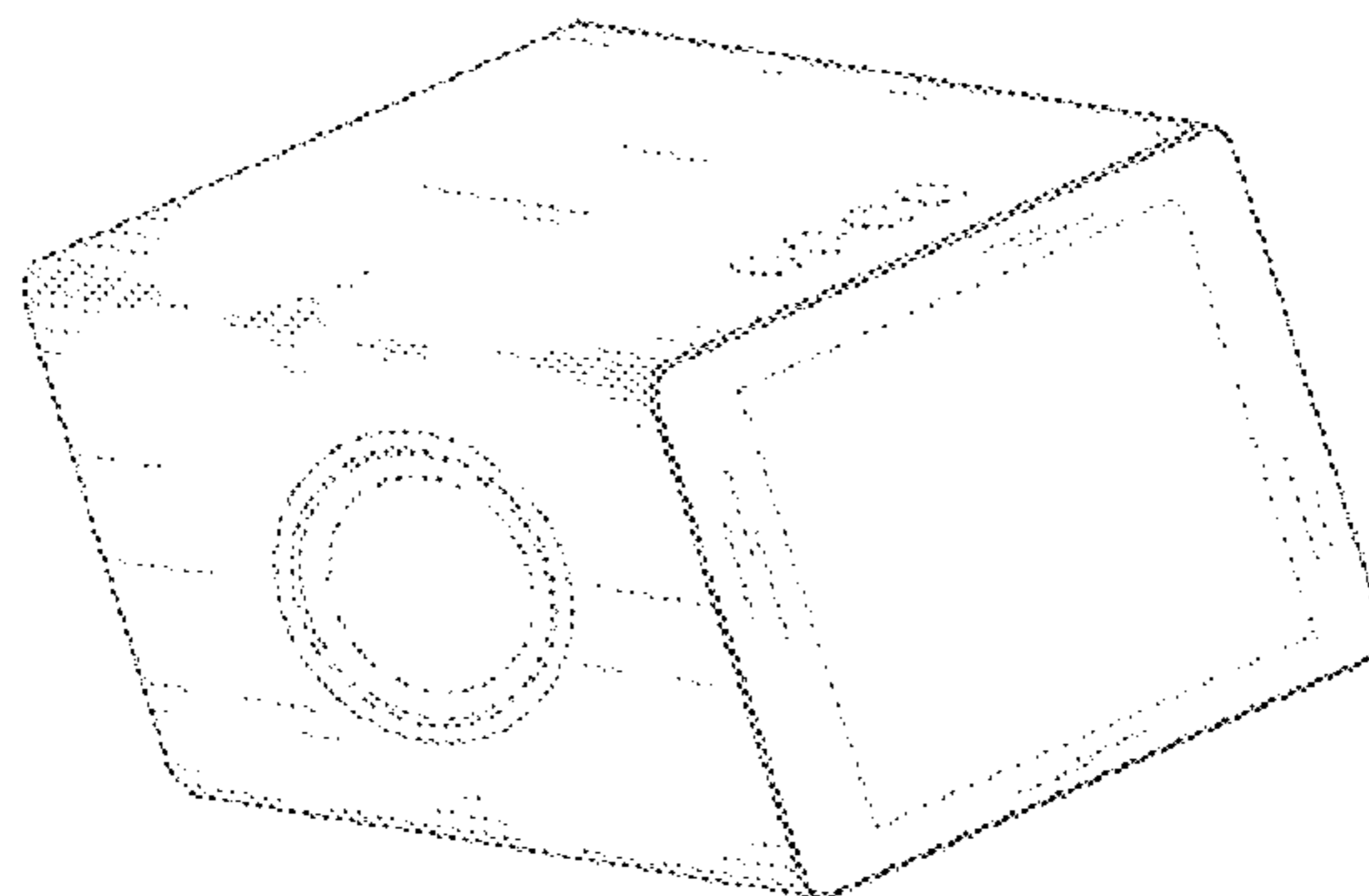

The broken lines are for illustrative purposes only and form no part of the claimed design.

1 Claim, 10 Drawing Sheets

(56)

References Cited

U.S. PATENT DOCUMENTS

8,384,527	B2 *	2/2013	Irwin	G04G 13/02
					340/309.16
D691,983	S *	10/2013	Vaughan	D14/172
D692,848	S *	11/2013	Poandl	D14/172
8,616,327	B1 *	12/2013	Palacios	H04M 1/035
					181/175
D714,249	S *	9/2014	Carney	D14/140
D725,624	S *	3/2015	Carney	D14/140

OTHER PUBLICATIONS

Author: Everything; Title: www.mreverything.net; Date: Oct. 26, 2015 (or earlier); Pages: homepage.

* cited by examiner

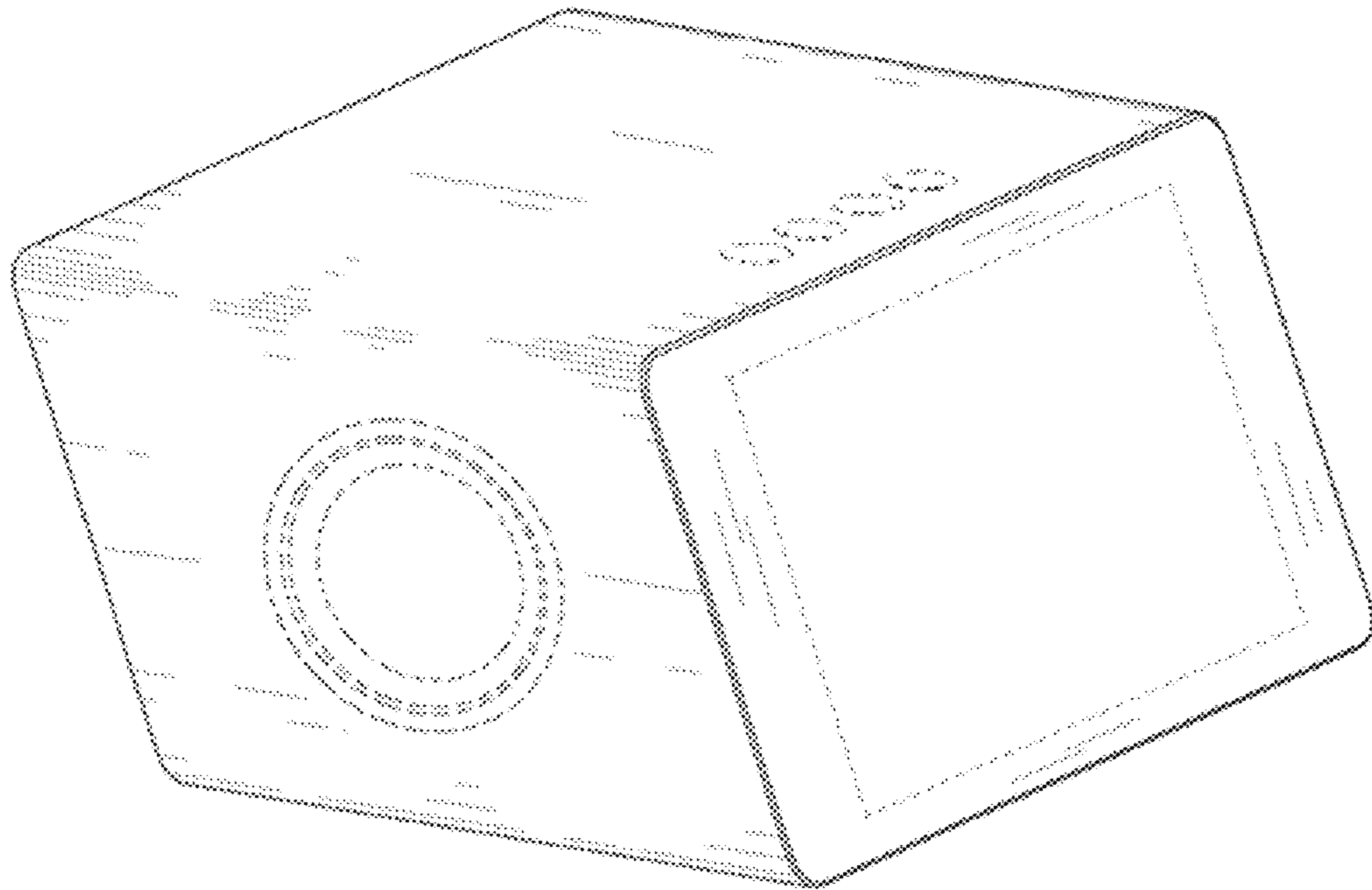

FIG. 1

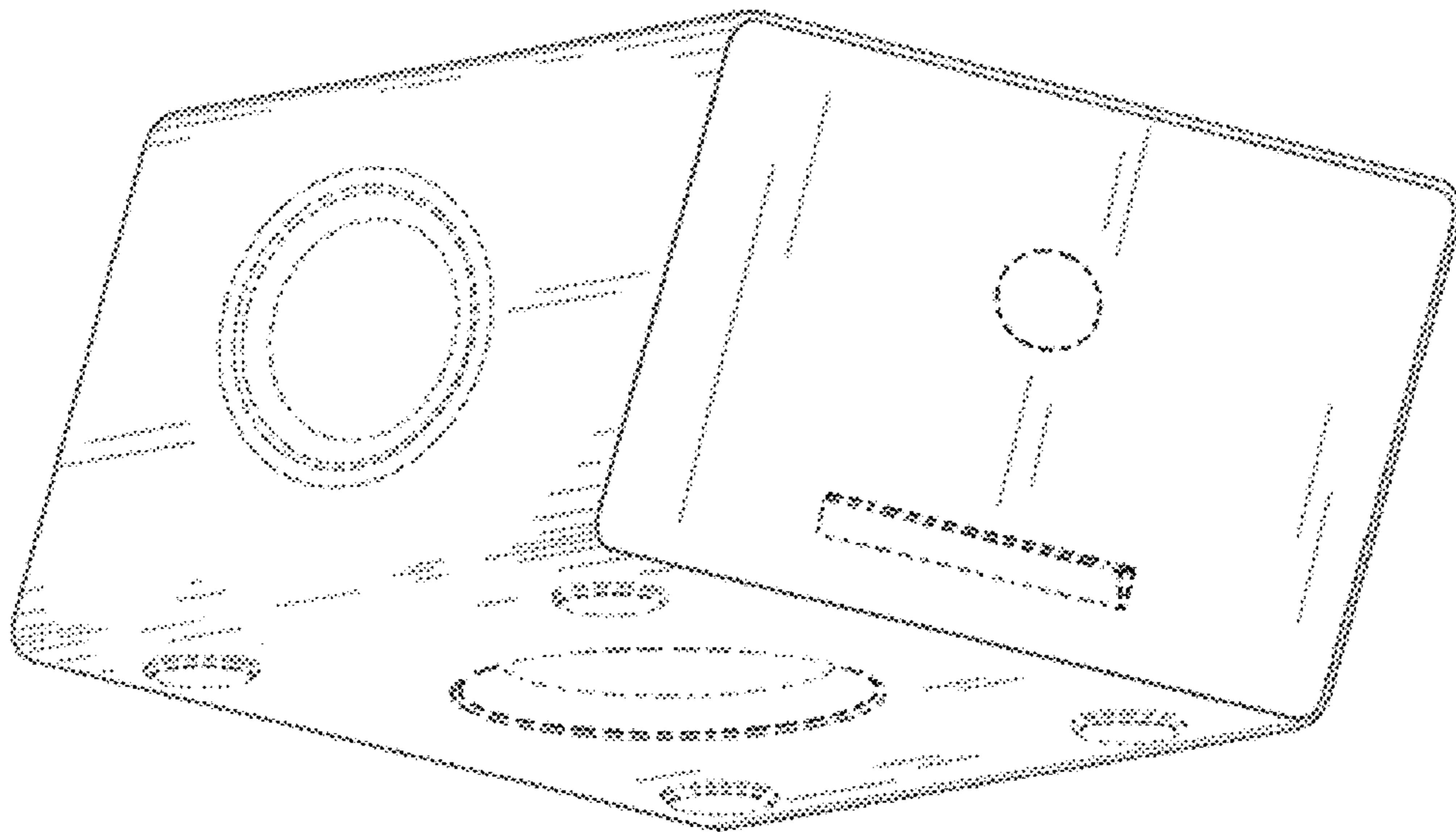

FIG. 2

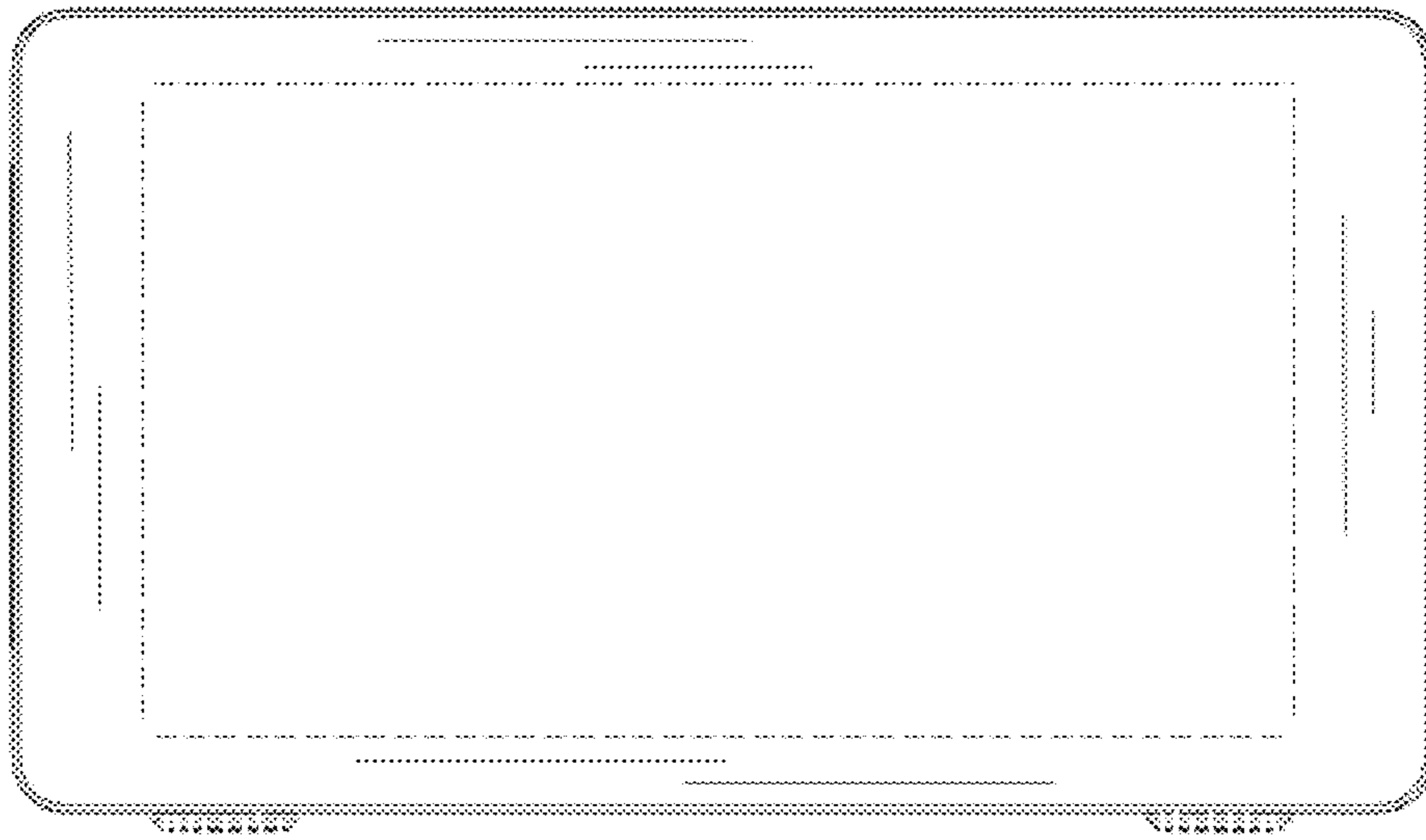

FIG. 3

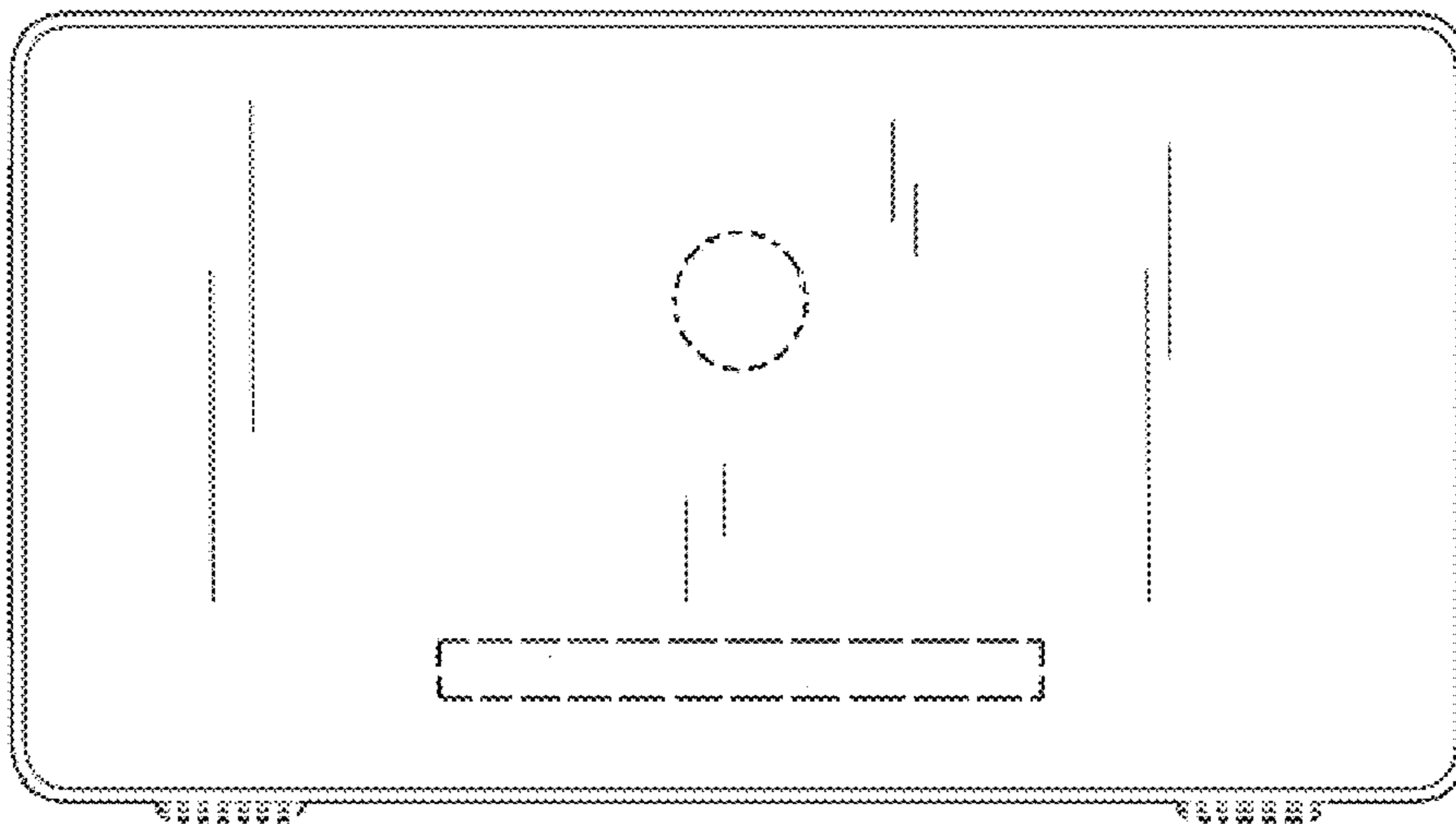

FIG. 4

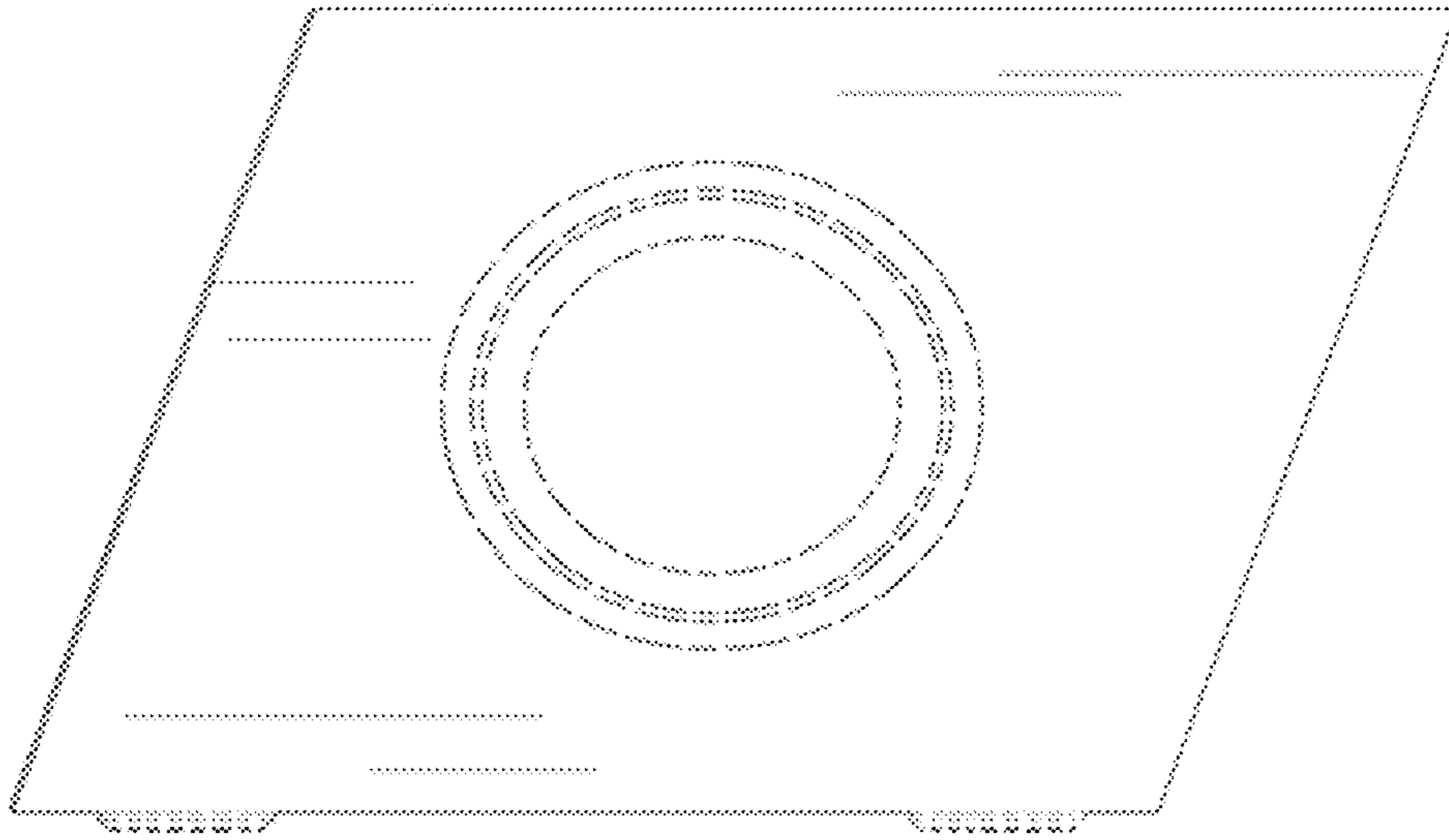

FIG. 5

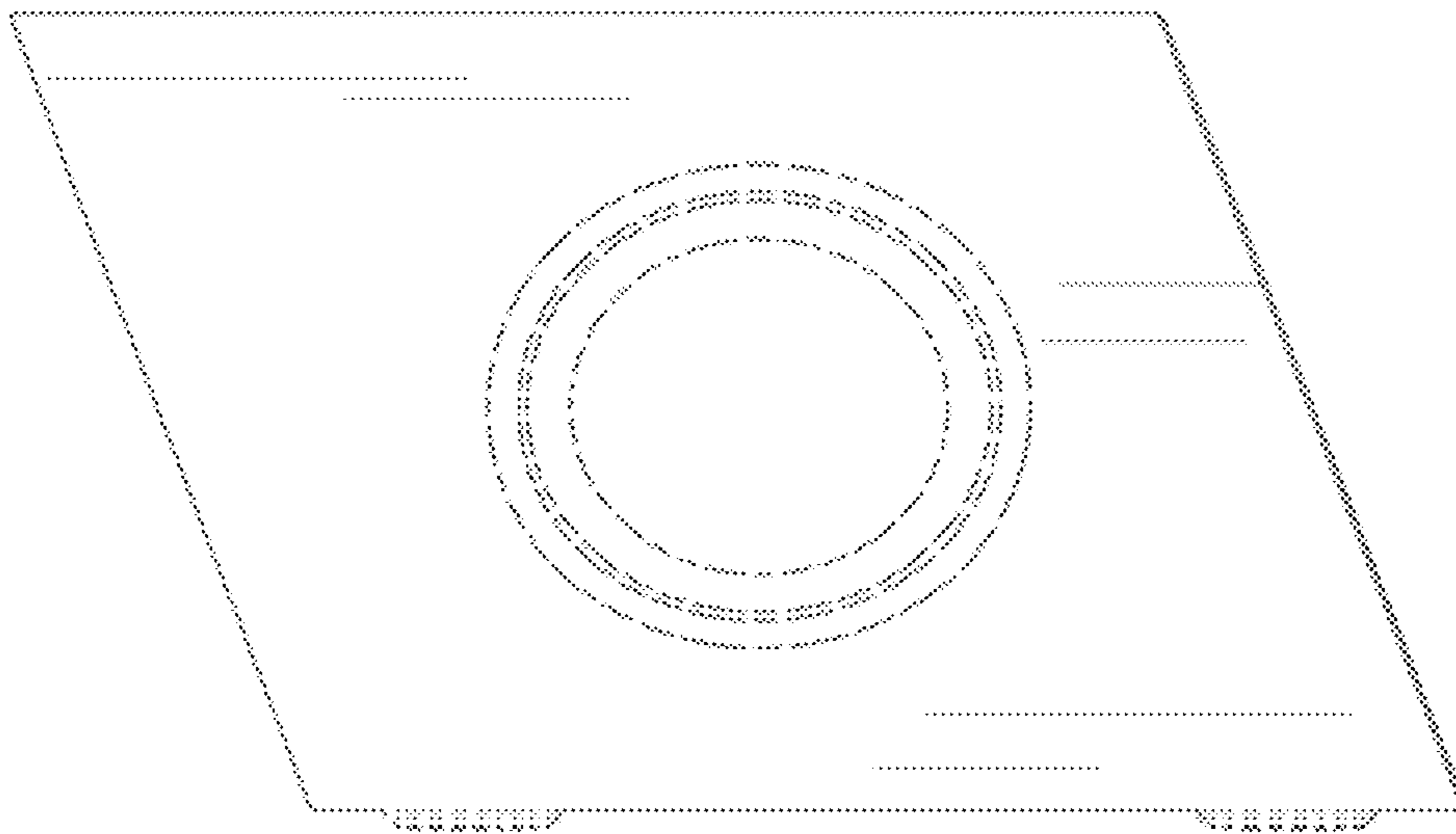

FIG. 6

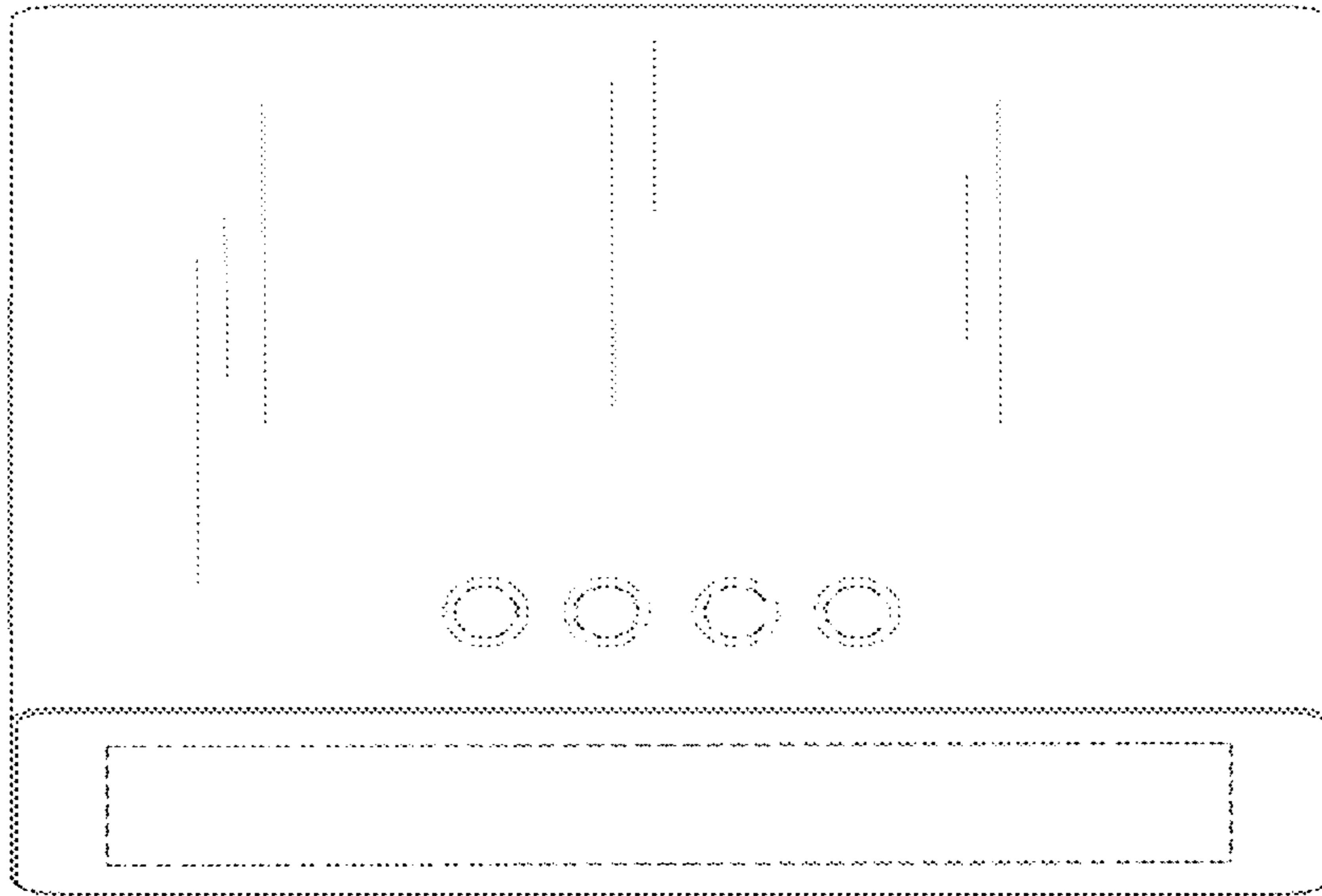

FIG. 7

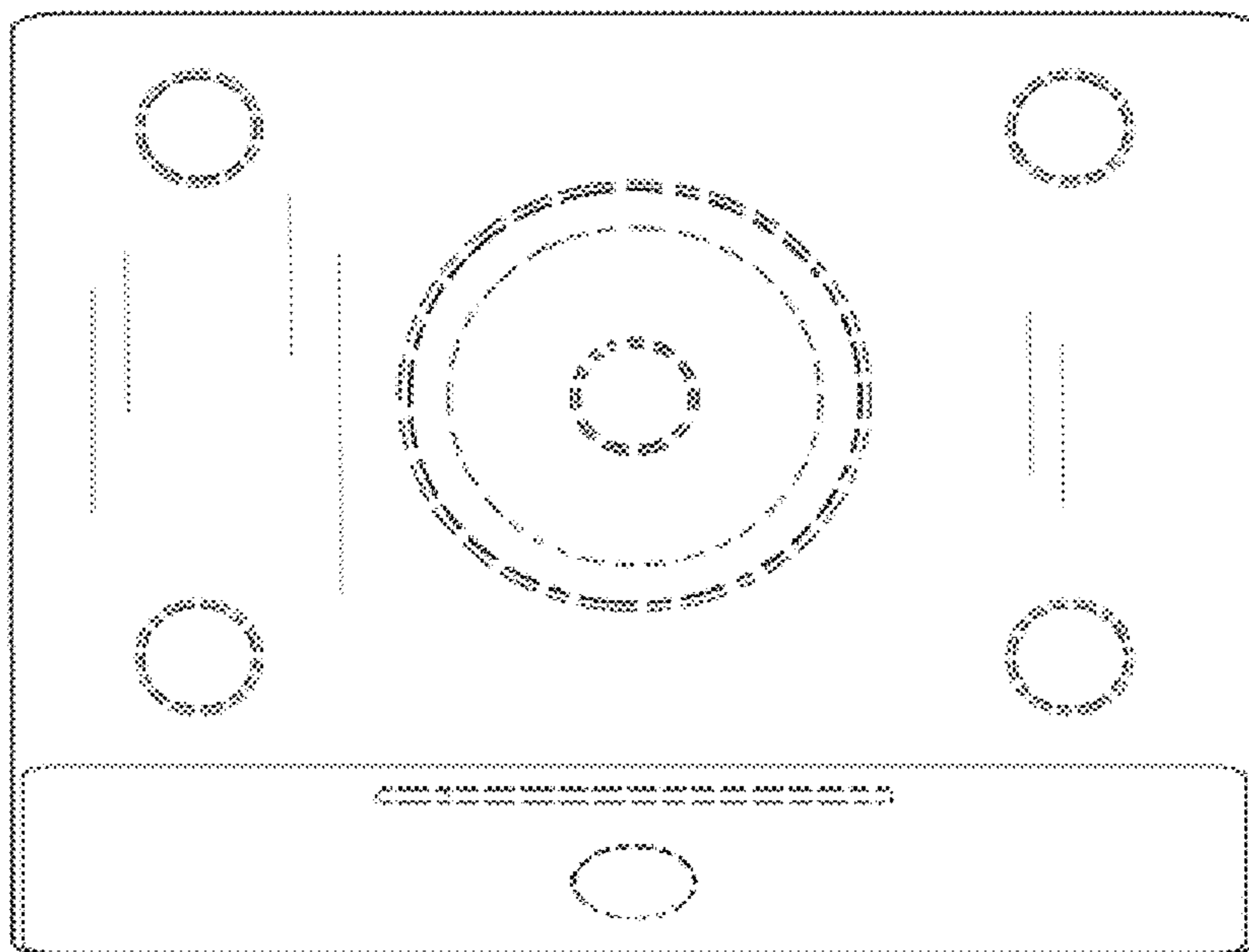

FIG. 8

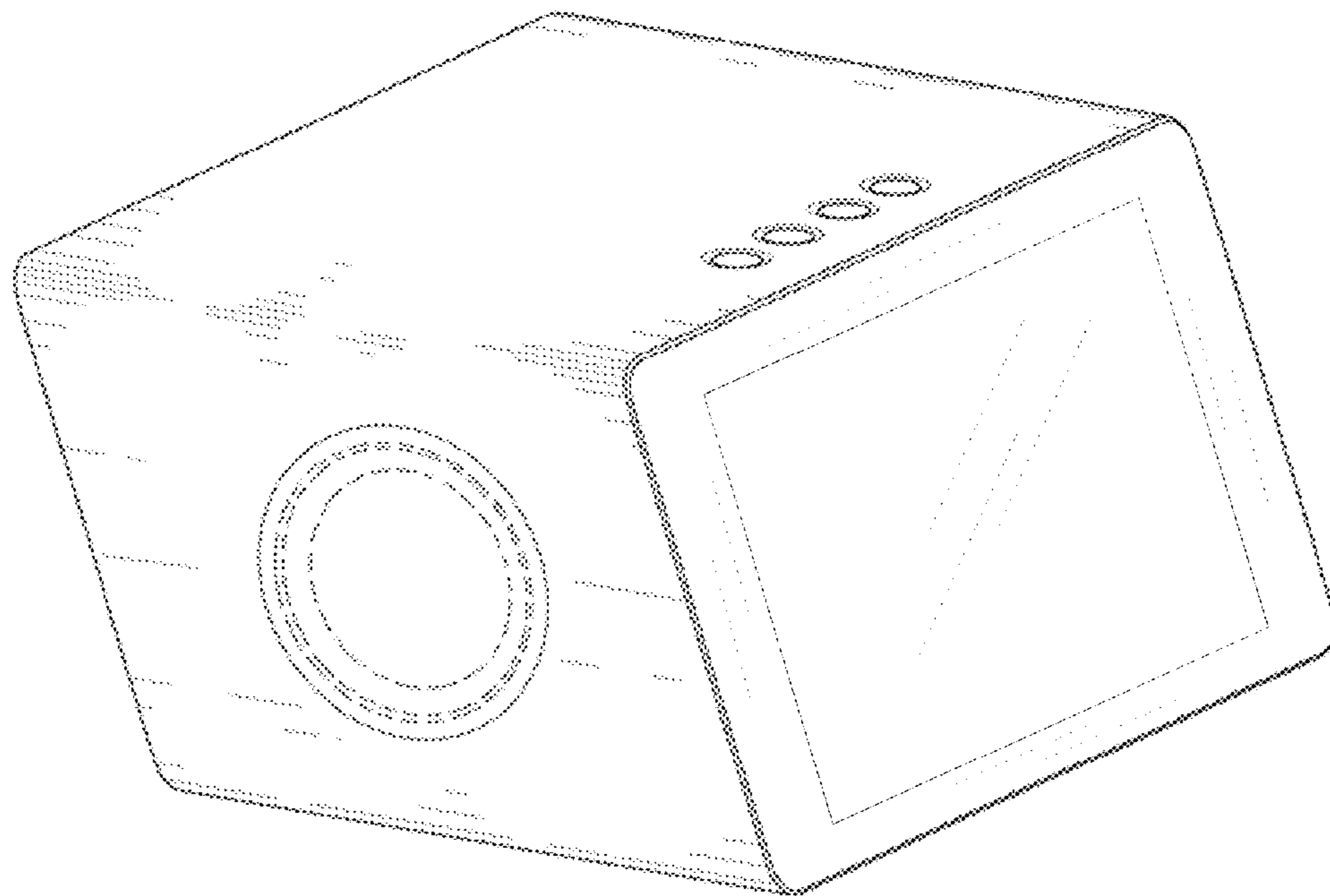

FIG. 9

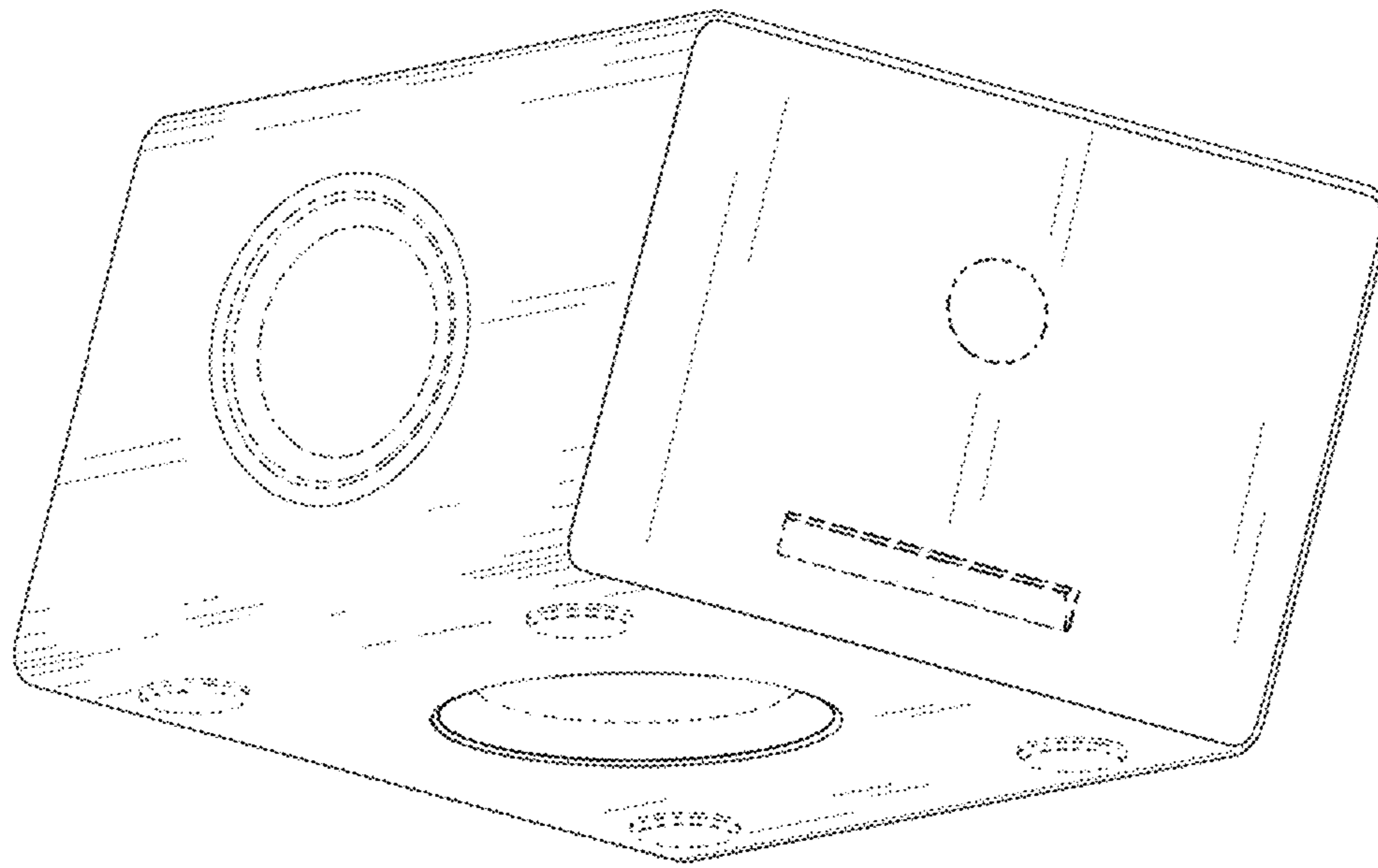

FIG. 10

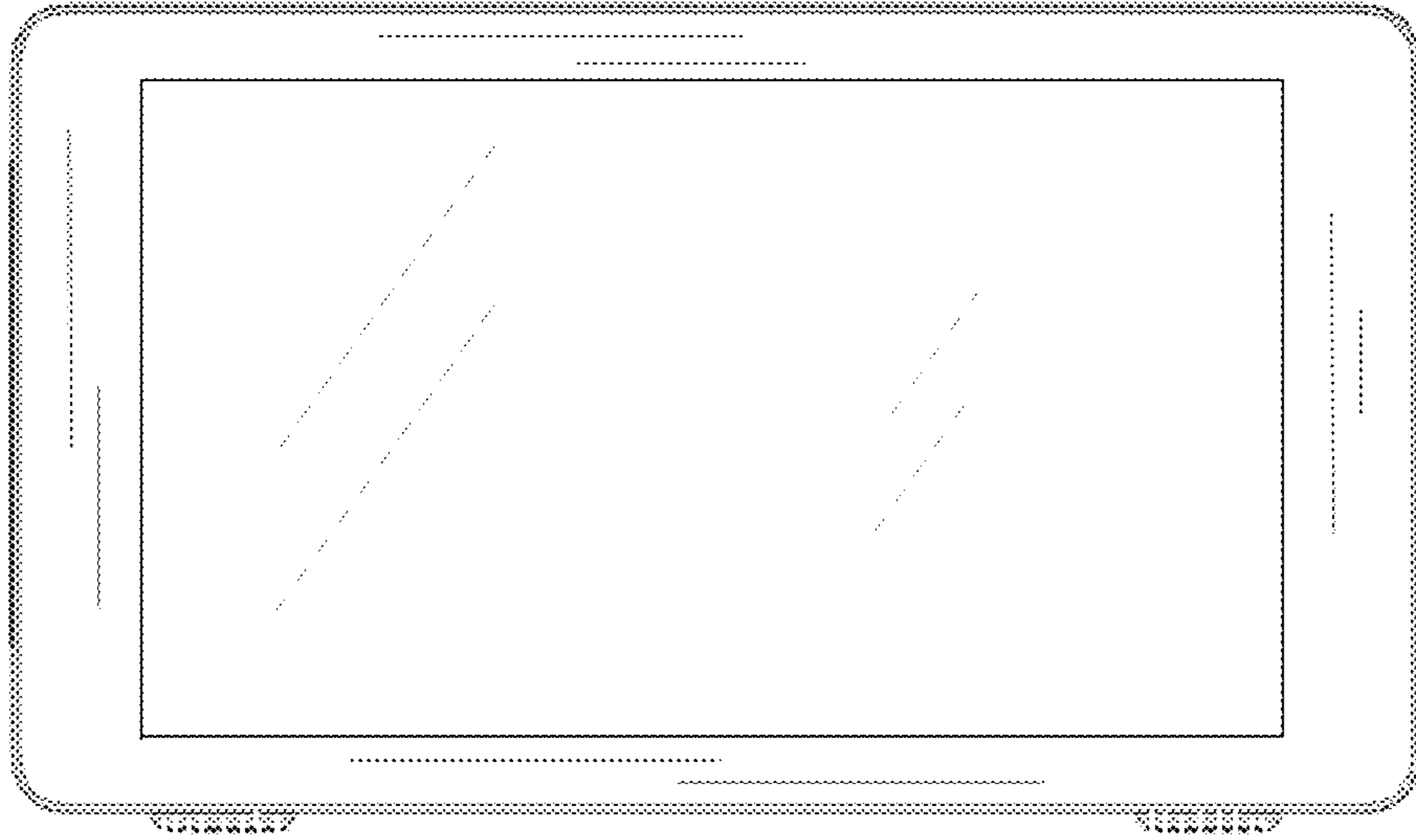

FIG. 11

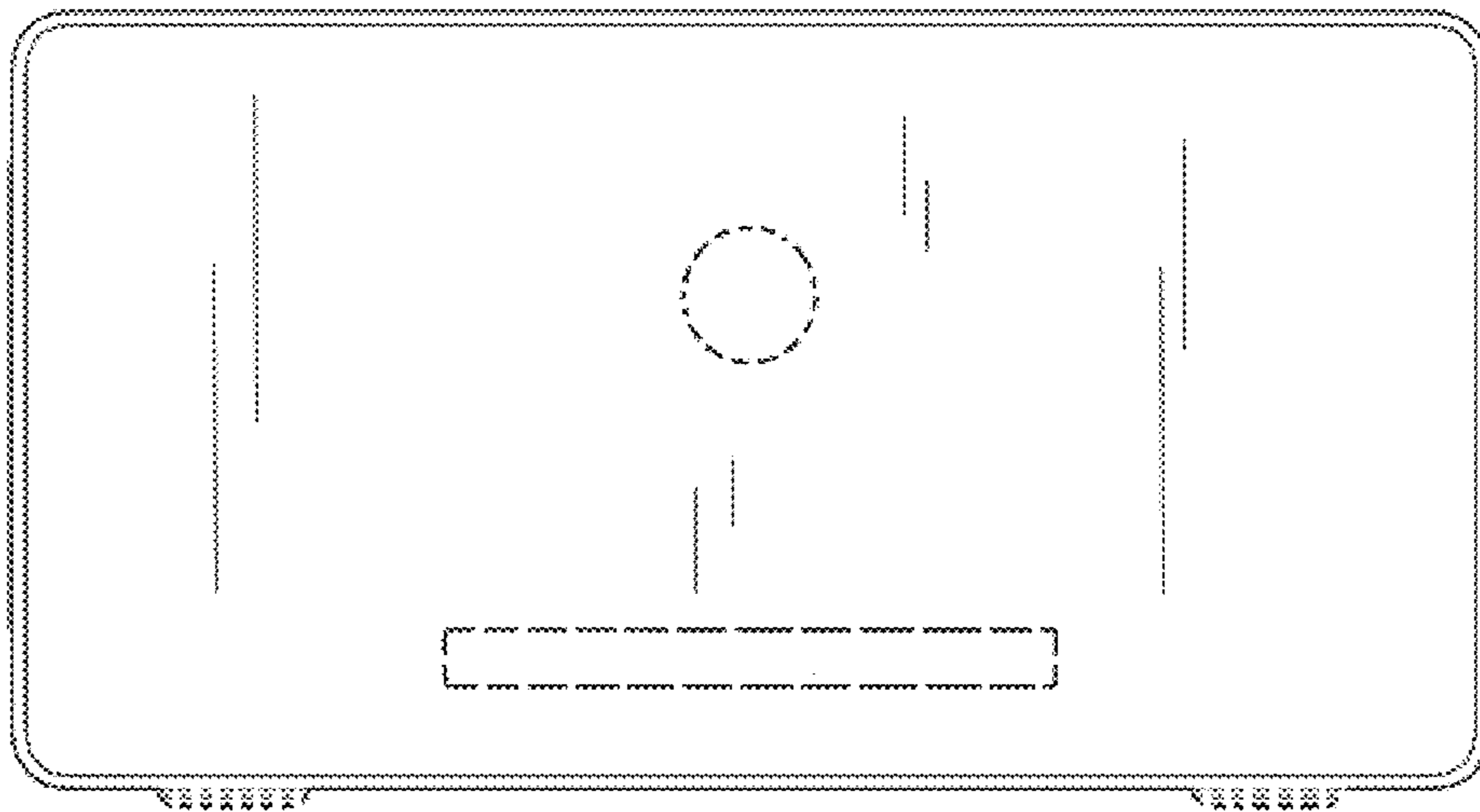

FIG. 12

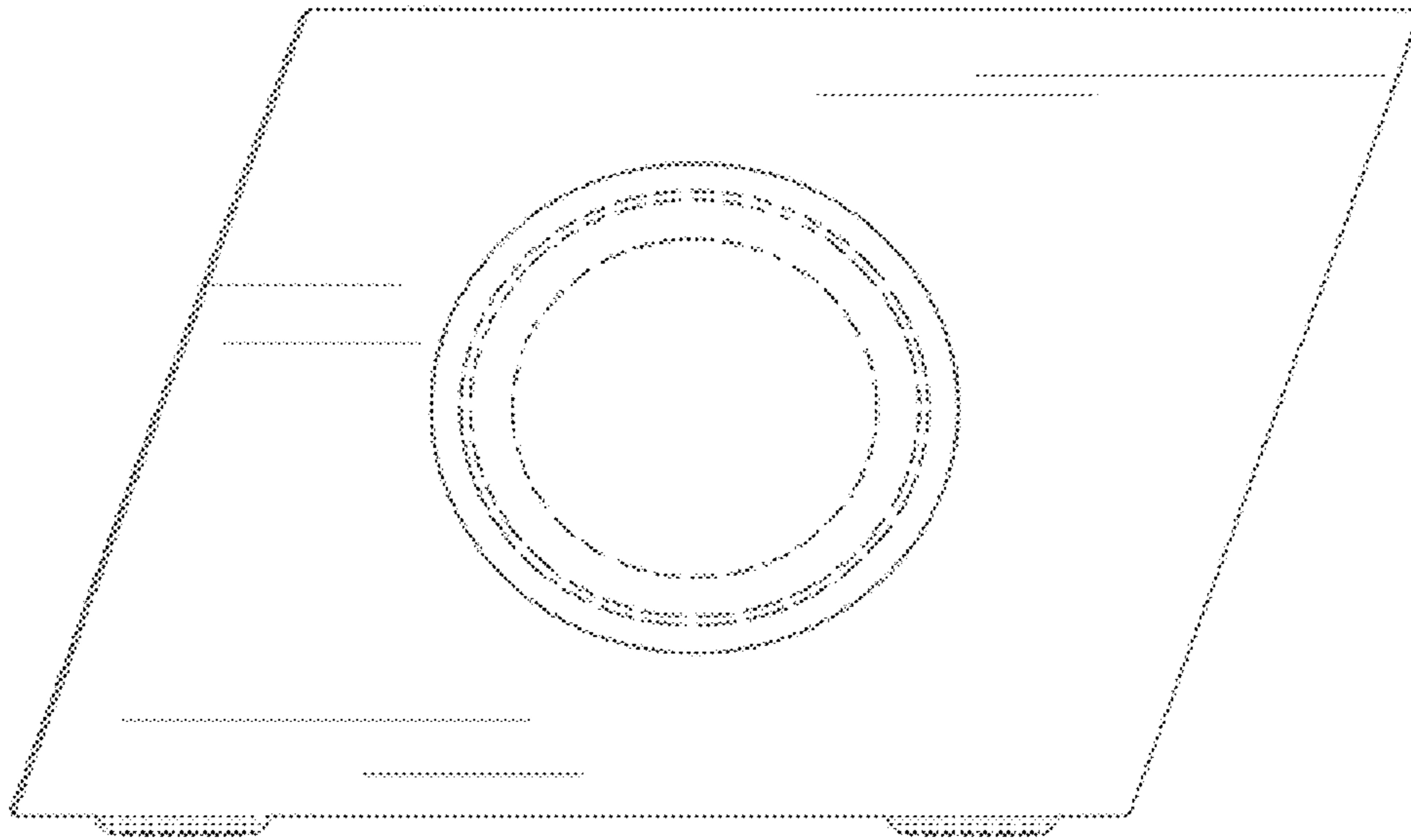

FIG. 13

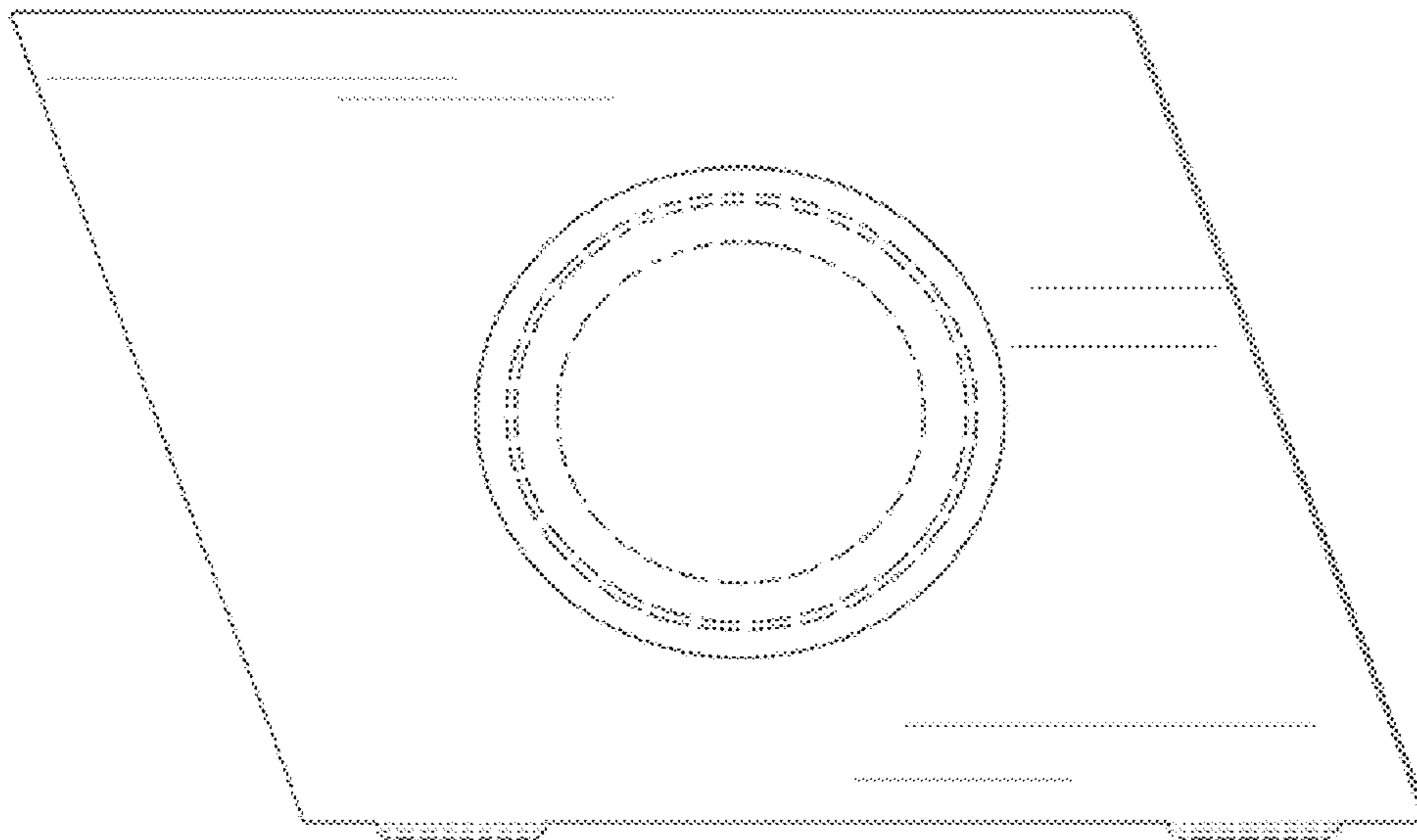

FIG. 14

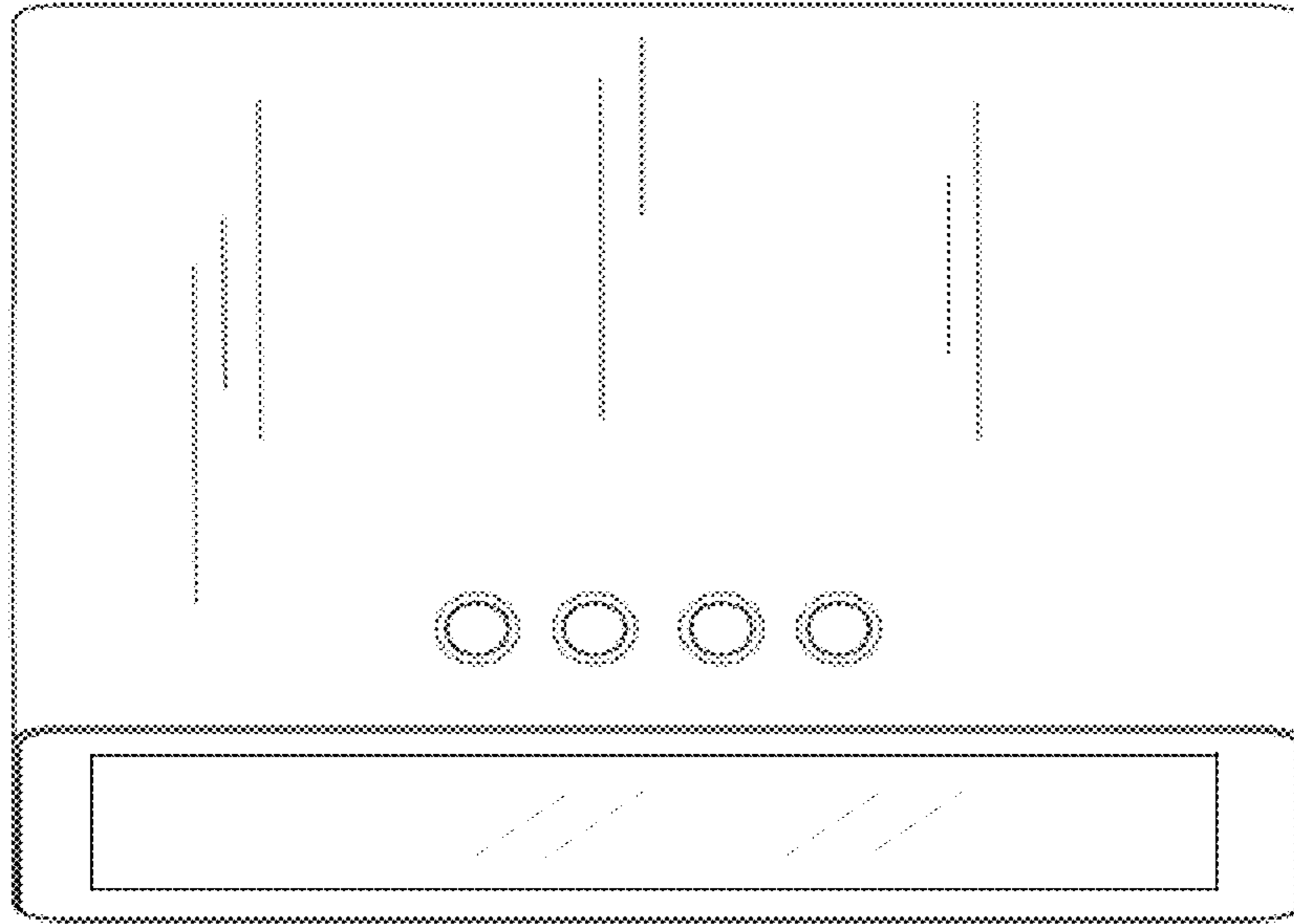

FIG. 15

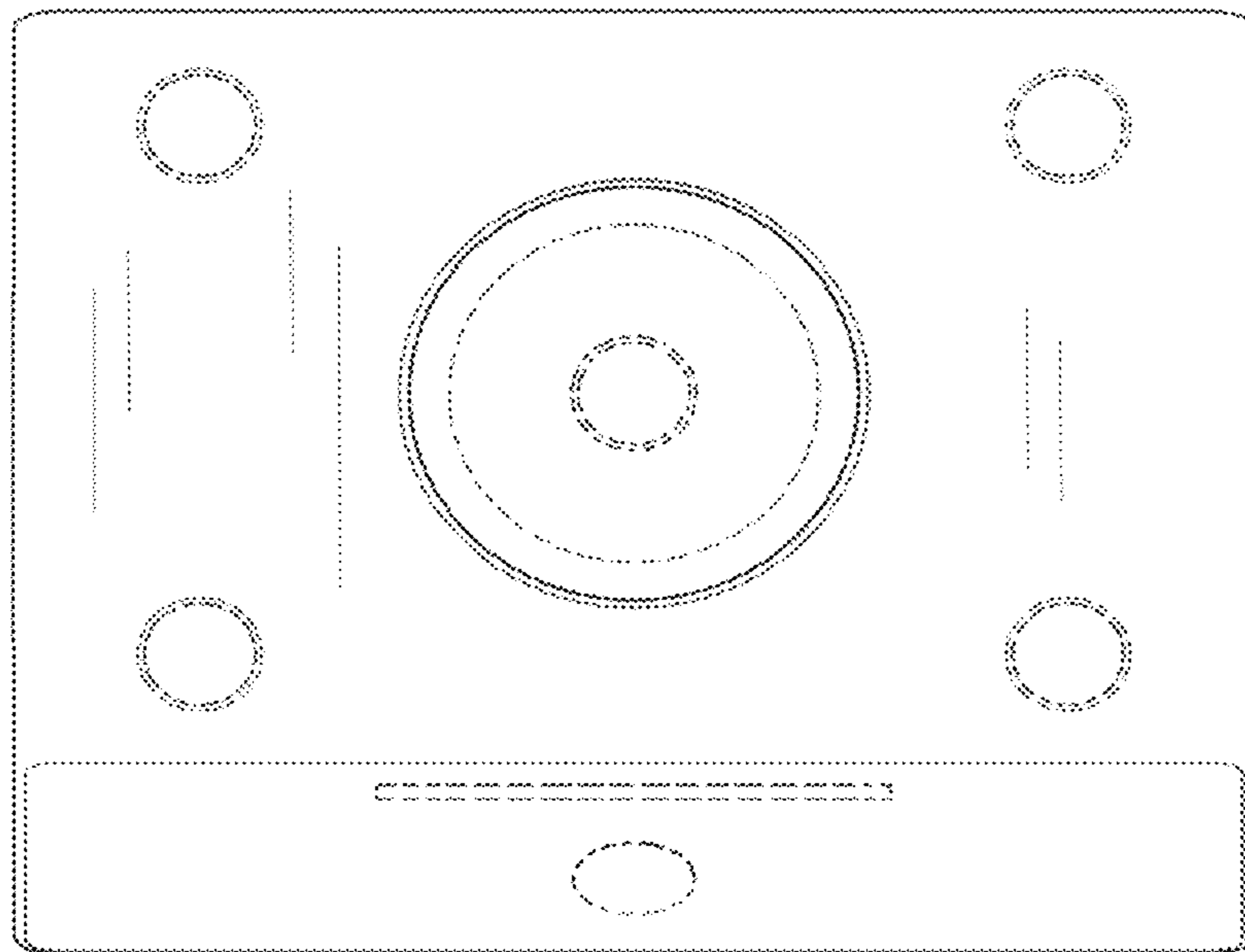

FIG. 16