



US00D779396S

(12) **United States Design Patent** (10) **Patent No.:** **US D779,396 S**  
**Patel et al.** (45) **Date of Patent:** **\*\* Feb. 21, 2017**

(54) **FRONT BUMPER**  
(71) Applicant: **Jaguar Land Rover Limited**, Whitley, Coventry (GB)  
(72) Inventors: **Paven Patel**, Coventry (GB); **Alex Chan**, Coventry (GB); **Luke Smith**, Coventry (GB)  
(73) Assignee: **Jaguar Land Rover Limited**, Whitley, Coventry (GB)

D630,978 S \* 1/2011 Koshino ..... D12/169  
D643,350 S \* 8/2011 Furst ..... D12/169  
D665,712 S \* 8/2012 Tanai ..... D12/169  
D673,086 S \* 12/2012 Frenzel ..... D12/169  
D721,021 S \* 1/2015 Hanaoka ..... D12/169  
D721,624 S \* 1/2015 George ..... D12/169  
D725,007 S \* 3/2015 Beaven ..... D12/164  
D725,562 S \* 3/2015 Beaven ..... D12/187  
D731,922 S \* 6/2015 Beaven ..... D12/91  
D739,305 S \* 9/2015 Gunnarson ..... D12/91  
D746,722 S \* 1/2016 Henstridge ..... D12/91  
D747,243 S \* 1/2016 Patel ..... D12/169

(Continued)

(\*\*) Term: **15 Years**

**OTHER PUBLICATIONS**

(21) Appl. No.: **29/532,493**

Carbuyer, New Jaguar F-Pace 2016 review, May 6, 2016, youtube.com [online], [site visited Jul. 26, 2016]. Available from Internet: <<https://www.youtube.com/watch?v=4kfc0xu---s>>.\*

(22) Filed: **Jul. 7, 2015**

(Continued)

**Foreign Application Priority Data**

Jan. 9, 2015 (EM) ..... 002611020  
Jun. 29, 2015 (EM) ..... 002727644  
Jul. 1, 2015 (EM) ..... 002729723

*Primary Examiner* — Karen Kearney  
*Assistant Examiner* — Katherine Holbrow  
(74) *Attorney, Agent, or Firm* — Wood Herron & Evans LLP

(51) **LOC (10) Cl.** ..... **12-16**

(52) **U.S. Cl.**  
USPC ..... **D12/169; D12/82**

(57) **CLAIM**

(58) **Field of Classification Search**  
USPC ..... D12/163, 164, 169, 171  
CPC .. B60R 19/02; B60R 2019/1886; B60R 19/48;  
B60R 19/52; B60R 19/56  
See application file for complete search history.

The ornamental design for a front bumper, as shown and described.

**DESCRIPTION**

(56) **References Cited**

**U.S. PATENT DOCUMENTS**

D575,694 S \* 8/2008 Opfer ..... D12/169  
D575,696 S \* 8/2008 Gale ..... D12/169  
D579,831 S \* 11/2008 Gabath ..... D12/169  
D584,200 S \* 1/2009 Leclercq ..... D12/169  
D589,414 S \* 3/2009 Futschik ..... D12/169  
D615,910 S \* 5/2010 Borkert ..... D12/169  
D623,566 S \* 9/2010 Bauer ..... D12/169

FIG. 1 is a right front quarter view of a front bumper for a vehicle according to the present invention.  
FIG. 2 is a left rear quarter view thereof.  
FIG. 3 is a front view thereof.  
FIG. 4 is a rear view thereof.  
FIG. 5 is a left side view thereof.  
FIG. 6 is a right side view thereof; and,  
FIG. 7 is a top view thereof.

**1 Claim, 6 Drawing Sheets**

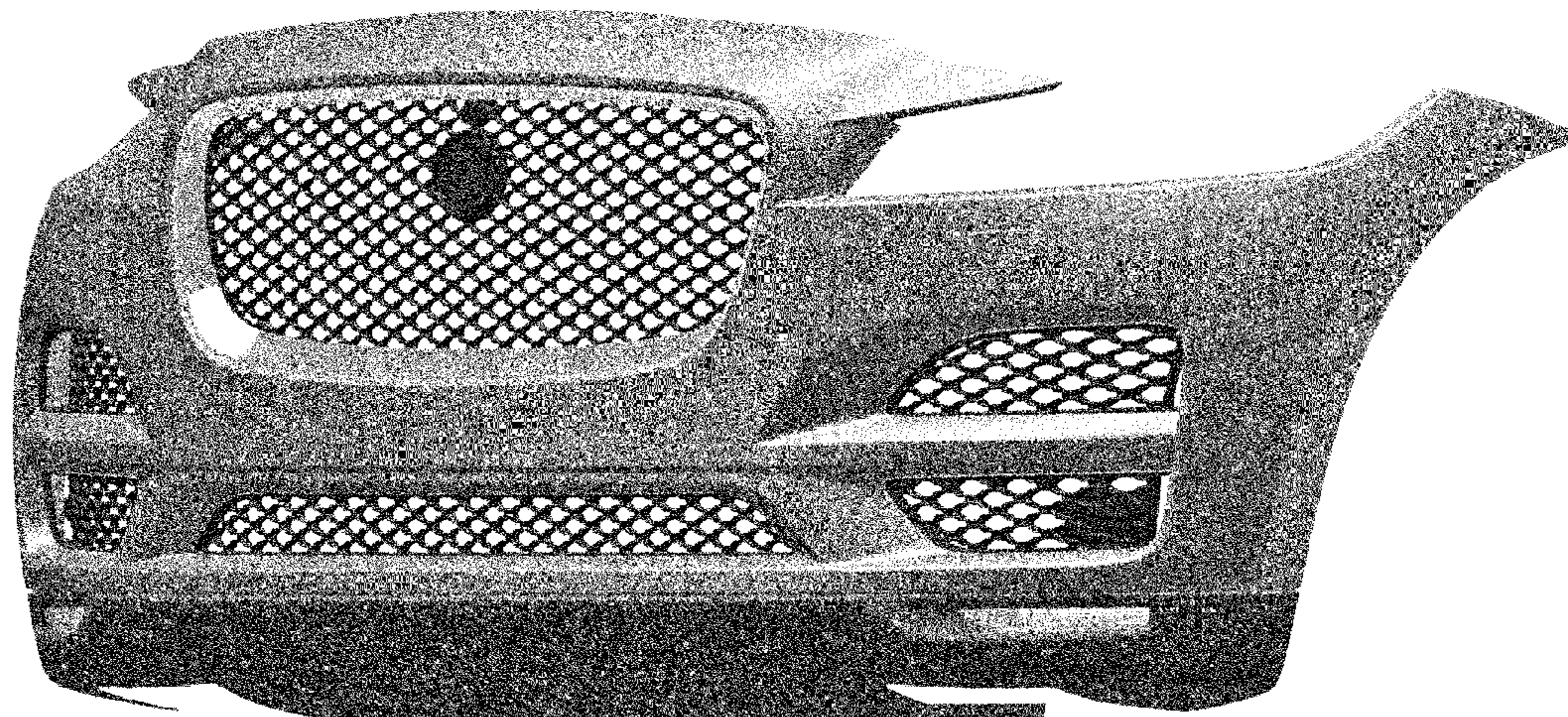

(56)

**References Cited**

U.S. PATENT DOCUMENTS

D749,474	S	*	2/2016	Battams	.....	D12/169
D750,538	S	*	3/2016	Buck	.....	D12/169
D752,481	S	*	3/2016	Frascella	.....	D12/91
D753,557	S	*	4/2016	Frascella	.....	D12/169
D753,558	S	*	4/2016	Hatton	.....	D12/169
D758,921	S	*	6/2016	Hatton	.....	D12/92
2006/0249961	A1	*	11/2006	Flotzinger	.....	B60R 19/04 293/115
2007/0158962	A1	*	7/2007	Woodhouse	.....	B60R 19/24 293/120

OTHER PUBLICATIONS

Carjam TV, Jaguar F-Pace SUV, Sep. 13, 2013, youtube.com [online], [site visited Jul. 26, 2016]. Available from Internet: <<https://www.youtube.com/watch?v=QEhkgbyiSys>>.\*

Bird, Matt, Jaguar F-Pace Review, Apr. 10, 2016, pistonheads.com [online], [site visited Jul. 26, 2016]. Available from Internet: <<http://www.pistonheads.com/road-tests/jaguar/jaguar-f-pace-review/34040>>.\*

\* cited by examiner

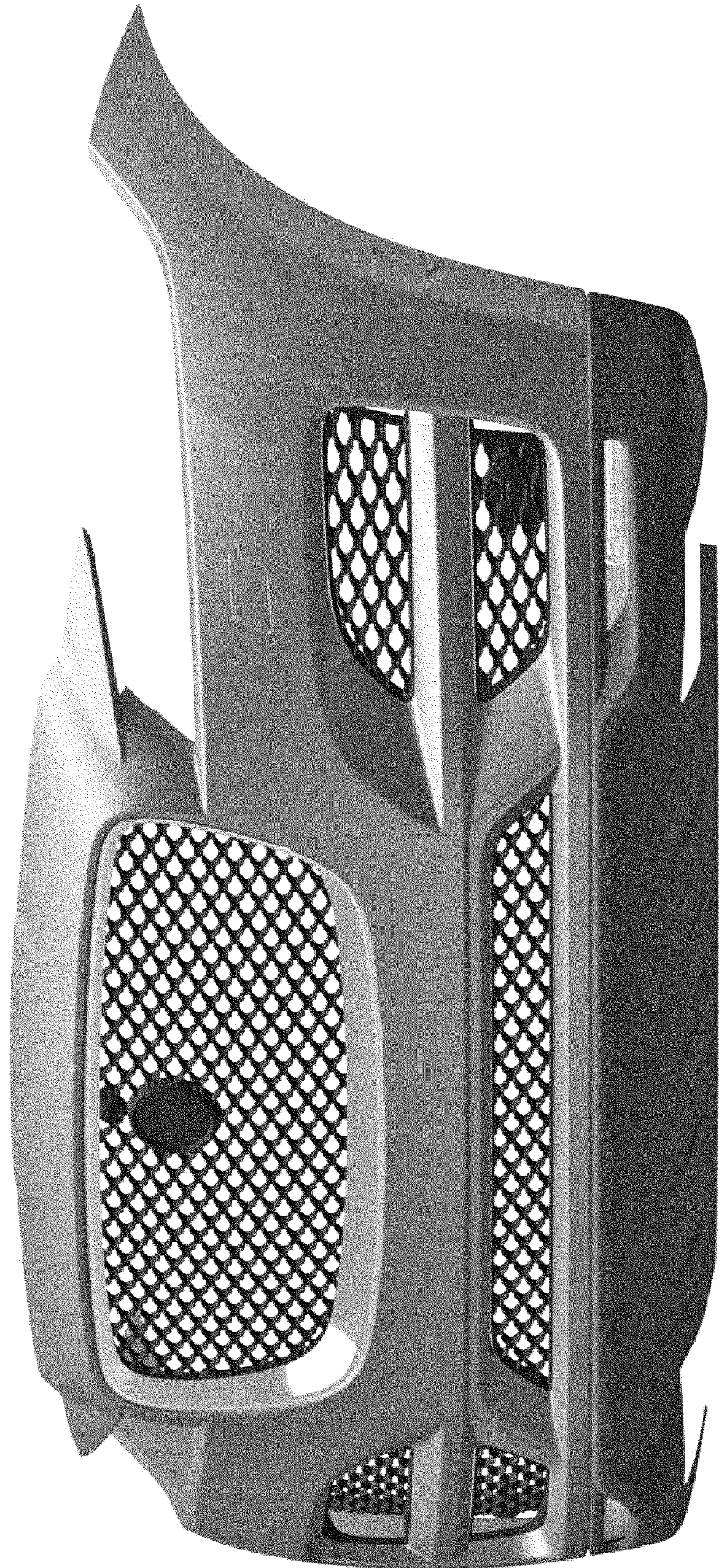

FIG. 1

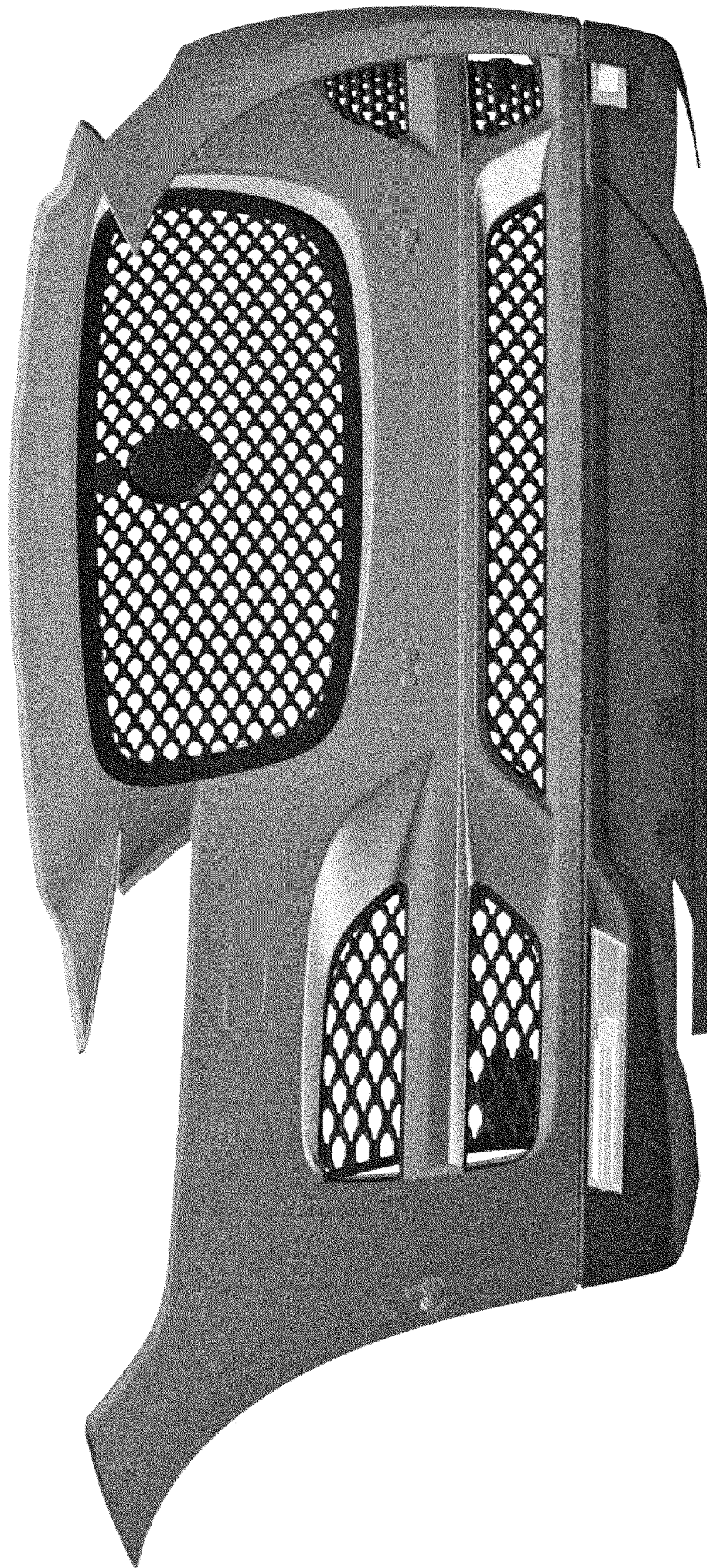

FIG. 2

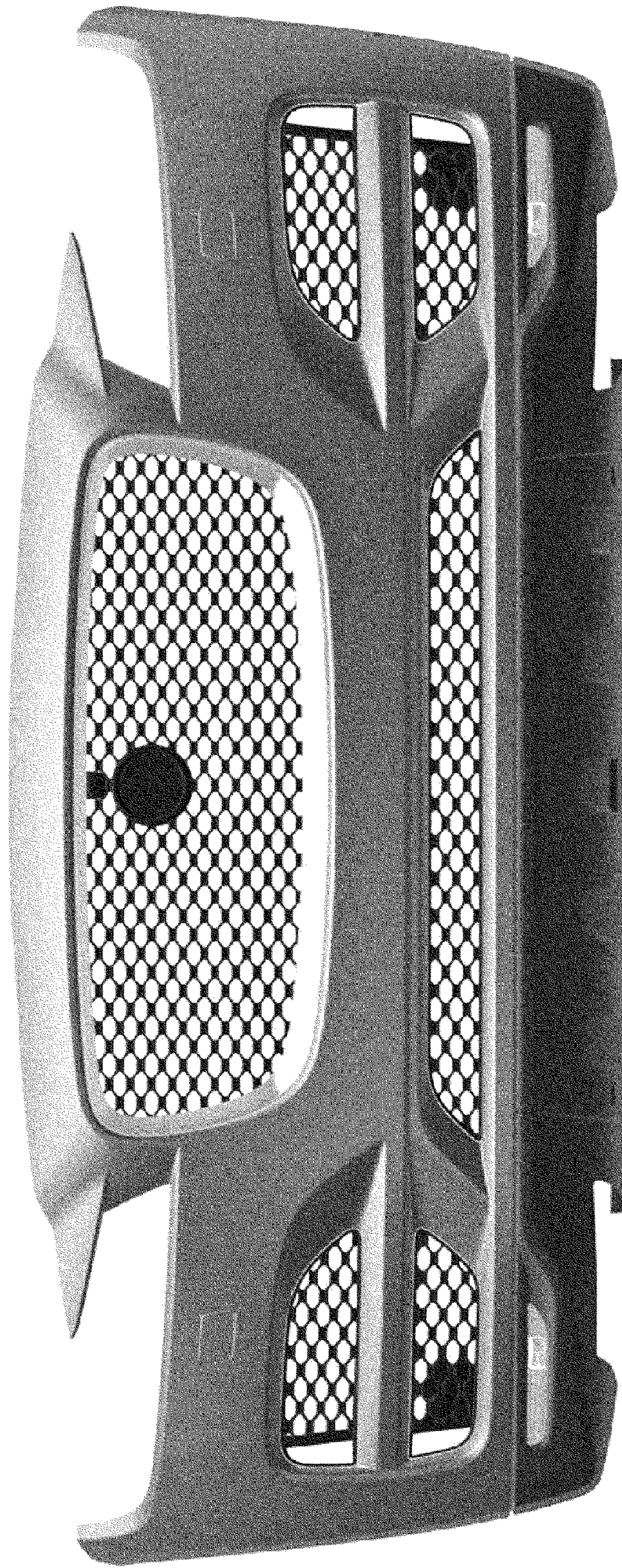

FIG. 3

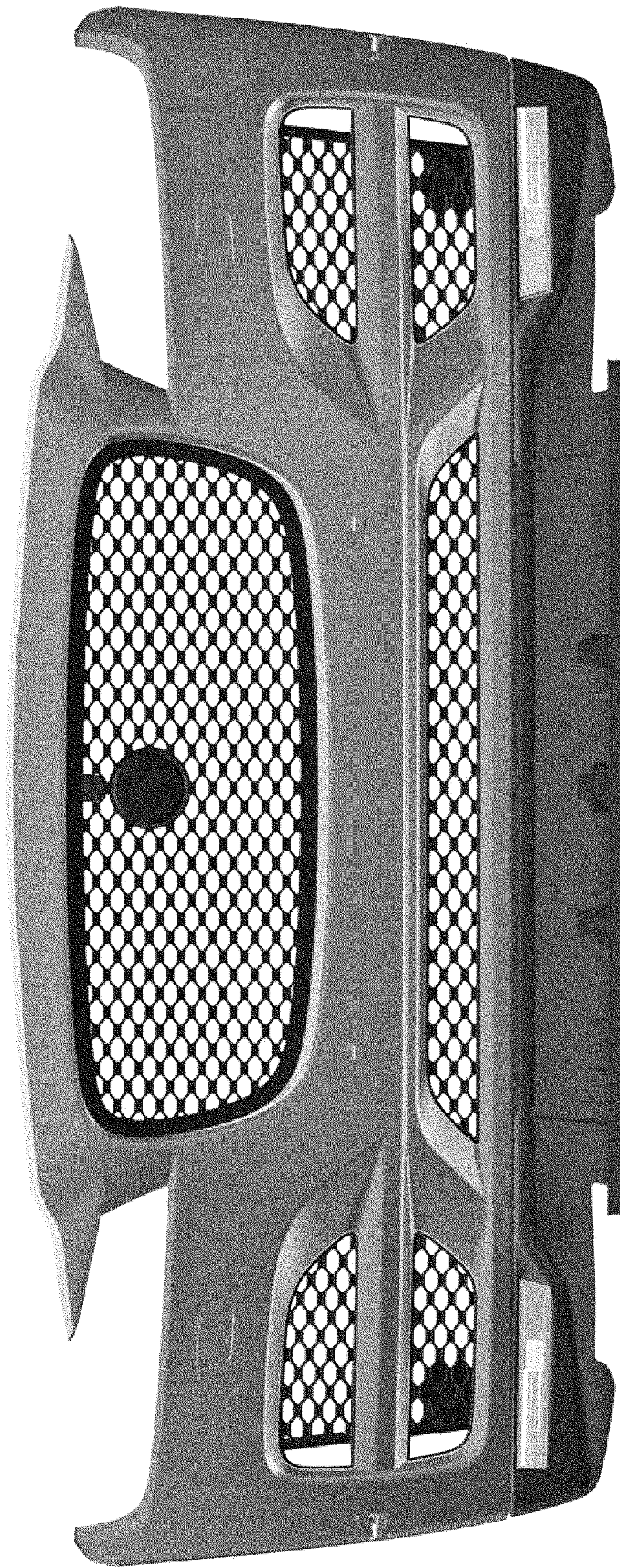

FIG. 4

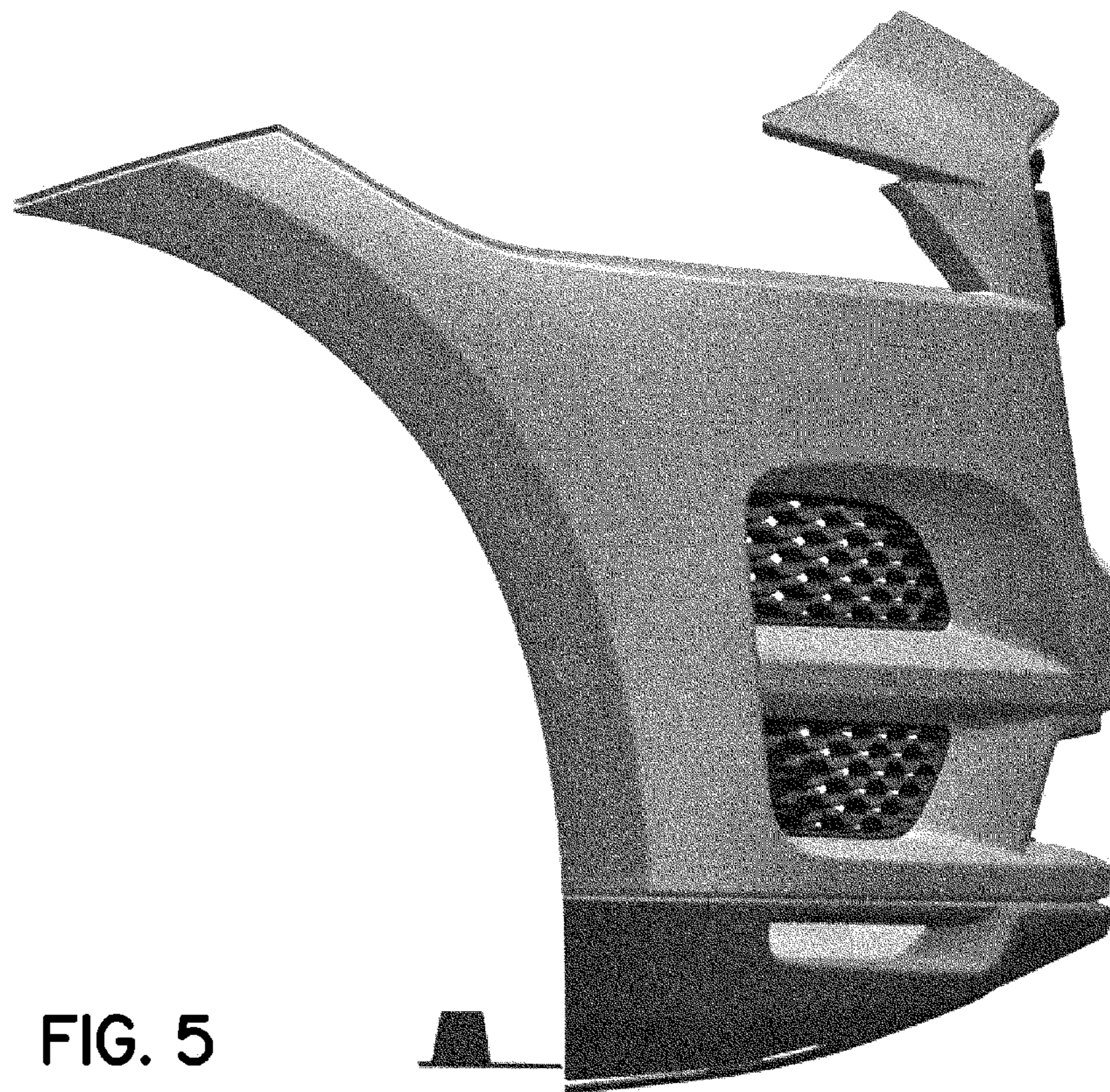

FIG. 5

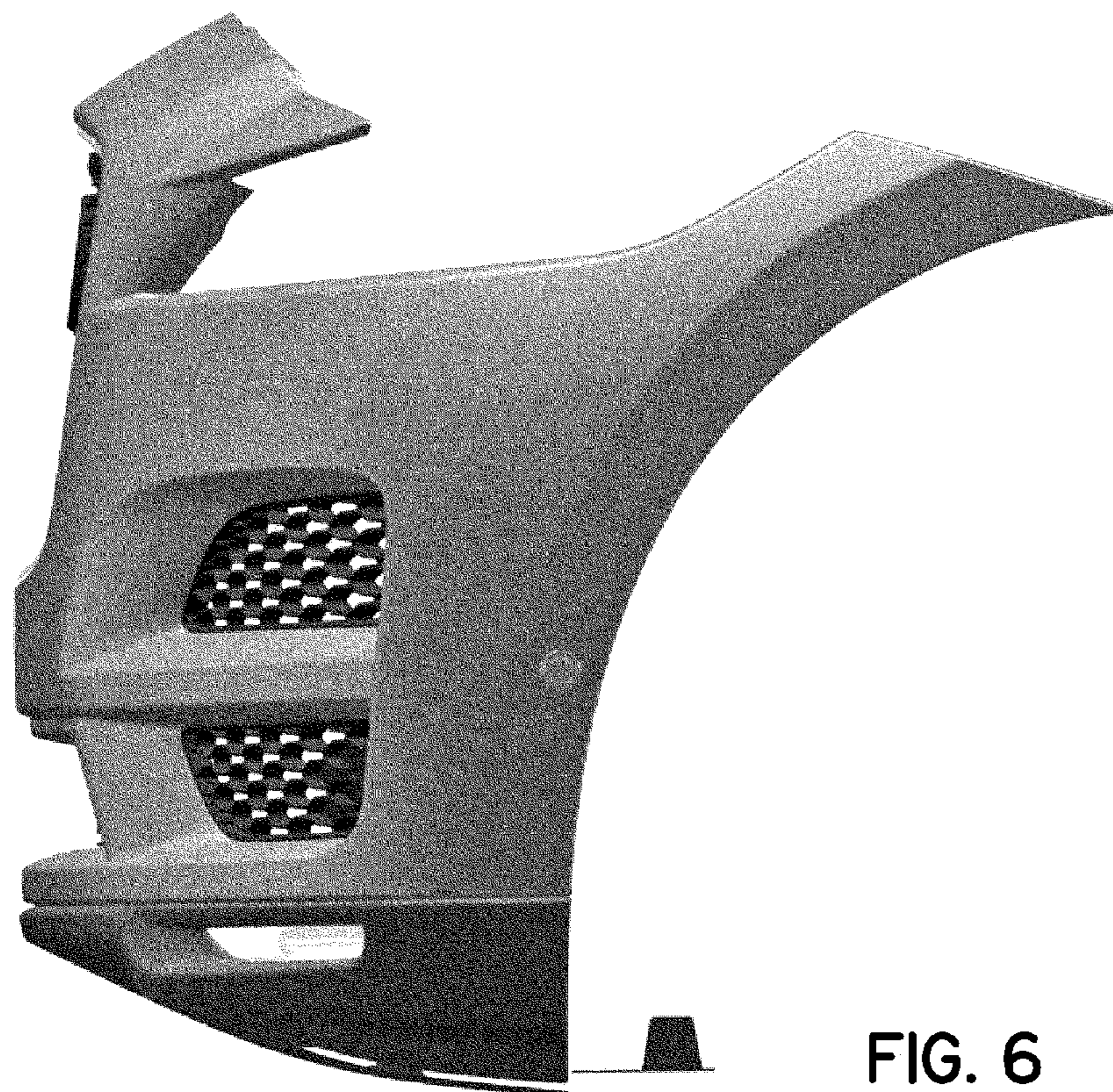

FIG. 6

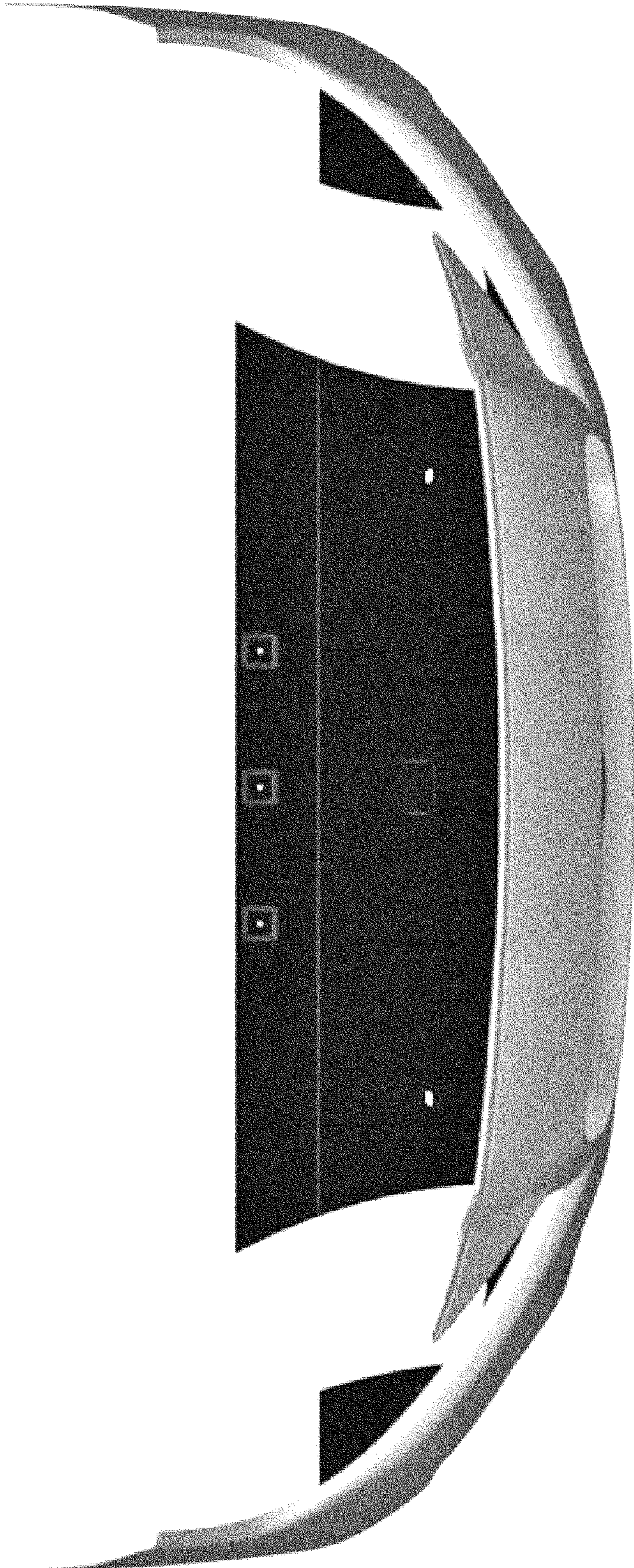

FIG. 7