



US00D779393S

(12) **United States Design Patent**
Kim et al.

(10) **Patent No.:** **US D779,393 S**

(45) **Date of Patent:** **** Feb. 21, 2017**

(54) **FRONT PORTION FOR A MOTOR VEHICLE**

(71) Applicants: **Jin Won Kim**, Tustin, CA (US); **Koichi Suga**, Toyota (JP); **Tsuneo Kanasugi**, Toyota (JP)

(72) Inventors: **Jin Won Kim**, Tustin, CA (US); **Koichi Suga**, Toyota (JP); **Tsuneo Kanasugi**, Toyota (JP)

(73) Assignee: **Toyota Jidosha Kabushiki Kaisha**, Toyota-shi, Aichi-ken (JP)

(**) Term: **15 Years**

(21) Appl. No.: **29/536,827**

(22) Filed: **Aug. 19, 2015**

(30) **Foreign Application Priority Data**

Feb. 20, 2015 (JP) 2015-003445

(51) **LOC (10) Cl.** **12-16**

(52) **U.S. Cl.**
USPC **D12/164**

(58) **Field of Classification Search**
USPC D12/86, 90-92, 164, 173, 184-186,
D12/190, 196; D21/424-425, 433-434
CPC B60R 13/04; B60R 19/54; B62D 25/12;
B62D 27/026; B62D 35/005; B60J 5/0412
See application file for complete search history.

(56) **References Cited**

U.S. PATENT DOCUMENTS

| | | | | |
|--------------|---------|-----------|-------|--------|
| D668,998 S * | 10/2012 | Matsumoto | | D12/91 |
| D671,036 S * | 11/2012 | Inatomi | | D12/92 |
| D680,906 S * | 4/2013 | Sugimoto | | D12/91 |
| D691,517 S * | 10/2013 | Kwon | | D12/92 |
| D706,169 S * | 6/2014 | Suga | | D12/91 |
| D715,195 S * | 10/2014 | Tomatsu | | D12/92 |
| D716,699 S * | 11/2014 | Sakae | | D12/92 |
| D719,065 S * | 12/2014 | Sakae | | D12/92 |

| | | | | |
|--------------|---------|---------|-------|--------|
| D725,000 S * | 3/2015 | Hirai | | D12/92 |
| D733,613 S * | 7/2015 | Tomatsu | | D12/91 |
| D743,845 S * | 11/2015 | Hirai | | D12/92 |

(Continued)

OTHER PUBLICATIONS

<https://www.youtube.com/watch?v=8QWCmJxWiTk>—Published Apr. 1, 2015.*

(Continued)

Primary Examiner — Manpreet Matharu

Assistant Examiner — Mojtaba Tehrani

(74) *Attorney, Agent, or Firm* — Finnegan, Henderson, Farabow, Garrett & Dunner, L.L.P.

(57) **CLAIM**

The ornamental design for a front portion for a motor vehicle, as shown and described.

DESCRIPTION

FIG. 1 is a front left perspective view of a front portion for a motor vehicle showing our new design;
FIG. 2 is a rear left perspective view thereof;
FIG. 3 is a front right perspective view thereof;
FIG. 4 is a rear right perspective view thereof;
FIG. 5 is a front view thereof;
FIG. 6 is a rear view thereof;
FIG. 7 is a left side view thereof;
FIG. 8 is a right side view thereof; and,
FIG. 9 is a top plan view thereof.

The bottom view forms no part of the claimed design. The de-emphasized and halftone portions shown in the photographs illustrate environmental structure for the front portion for a motor vehicle that forms no part of the claimed design.

1 Claim, 8 Drawing Sheets

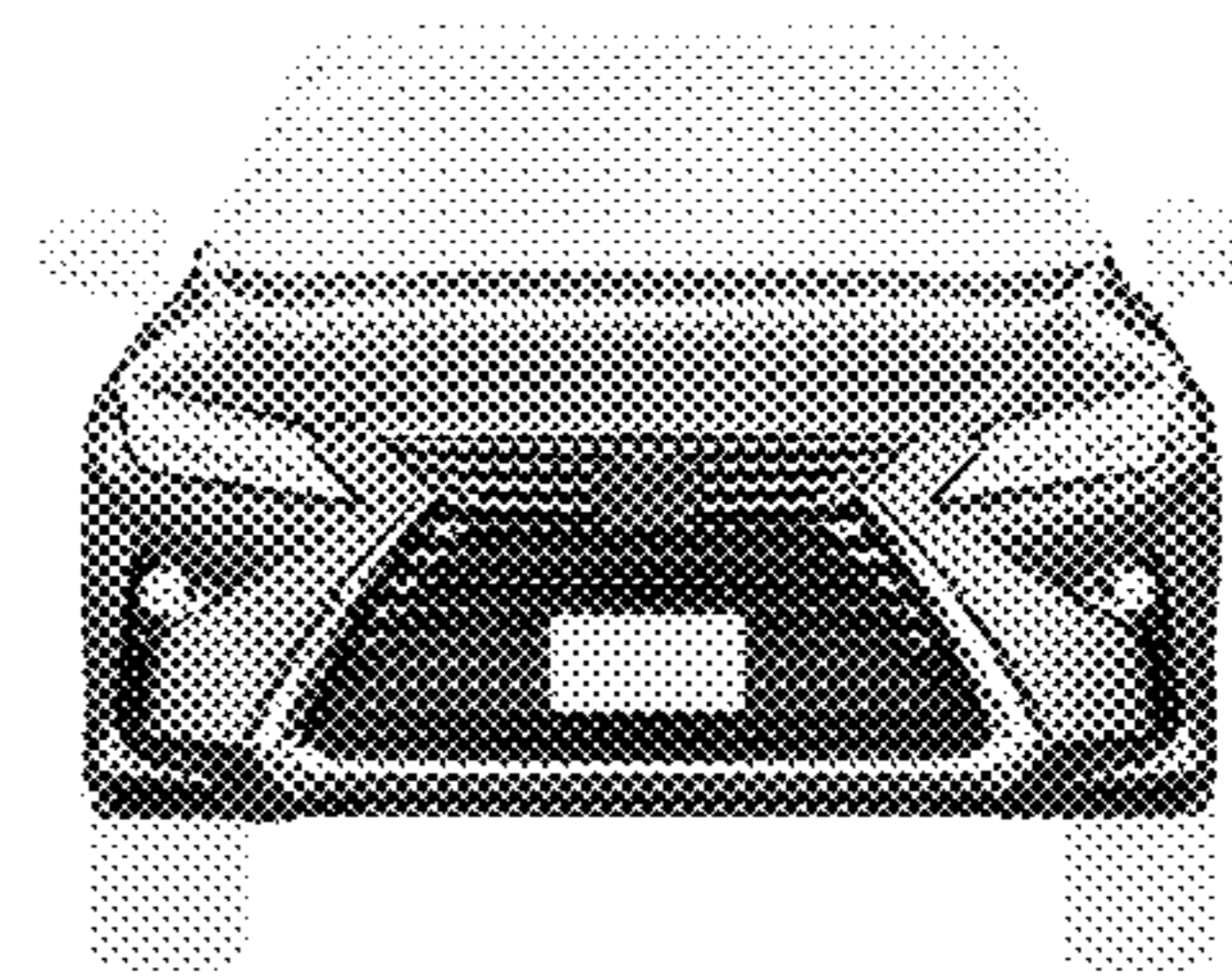
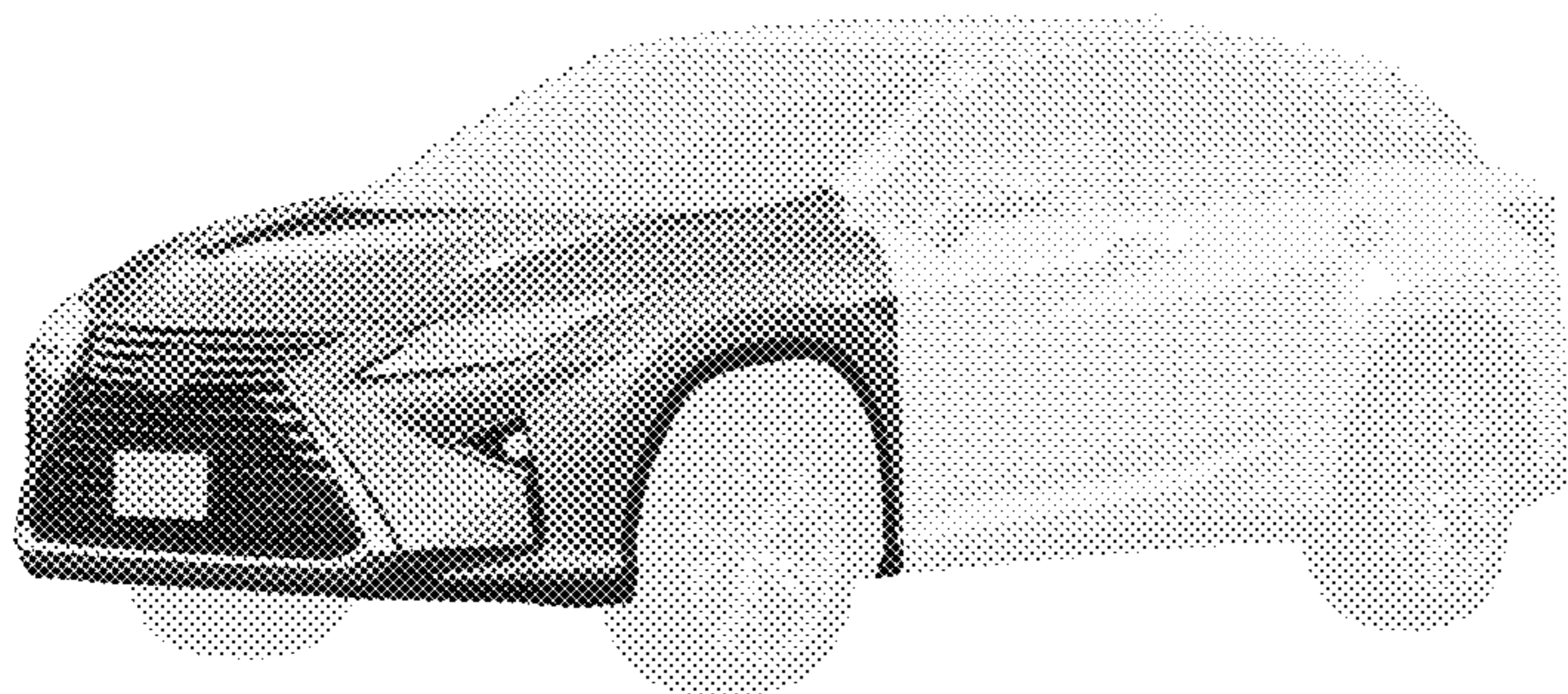

(56)

References Cited

U.S. PATENT DOCUMENTS

D744,377 S * 12/2015 Minami D12/91
D755,092 S * 5/2016 Isogai D12/164

OTHER PUBLICATIONS

<https://www.youtube.com/watch?v=AeZWBPdHdE>—Published
Sep. 16, 2015.*

Netcarshow.com; URL: http://www.netcarshow.com/lexus/2013-lf-nx_concept/; Model: LF-NX (2013); Mfg.: Lexus; available on at least Apr. 8, 2014.

Netcarshow.com; URL: http://www.netcarshow.com/lamborghini/2012-urus_concept/; Model: Urus Concept (2012); Mfg.: Lamborghini; available on at least Apr. 8, 2014.

Netcarshow.com; URL: <http://www.netcarshow.com/lexus/2015-rc/>; Model Lexus RC (2015); Mfg.: Lexus; available on at least Apr. 8, 2014.

* cited by examiner

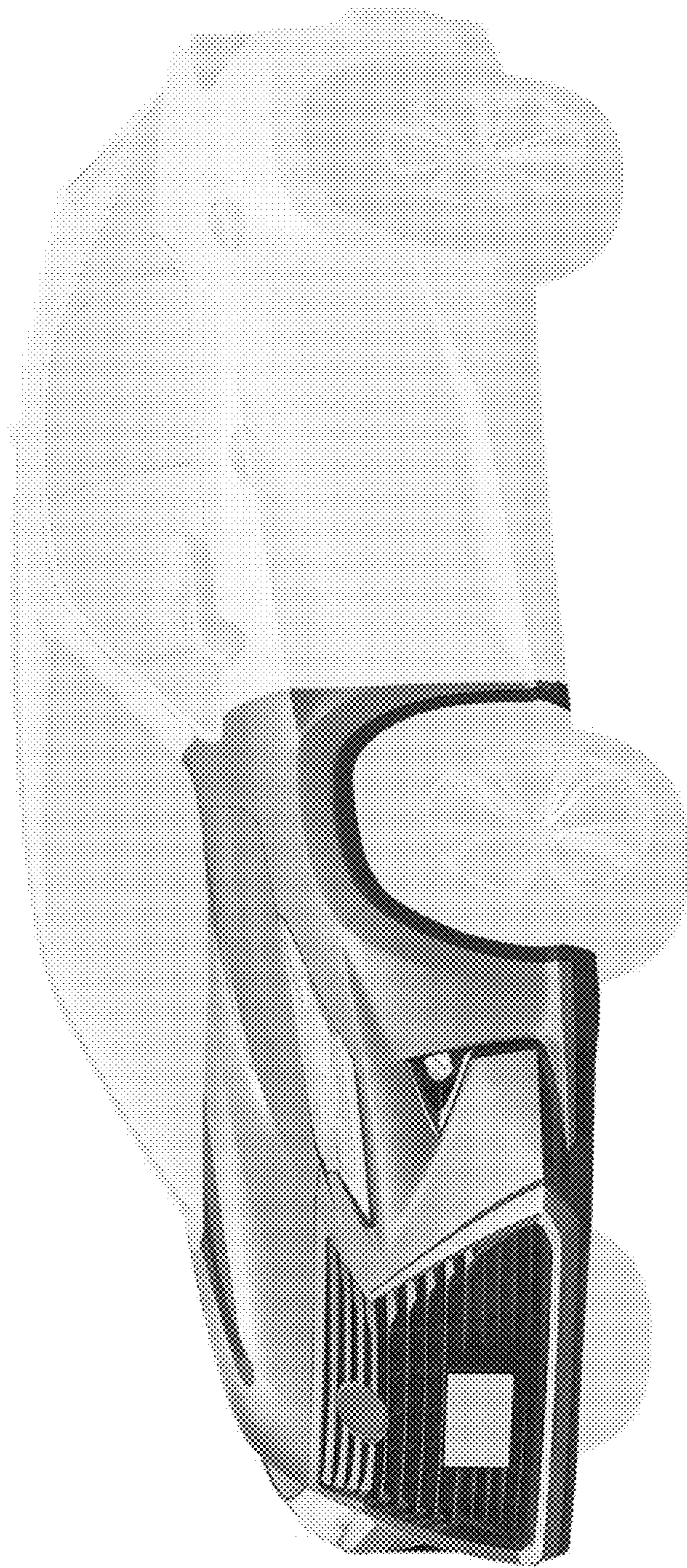

FIG. 1

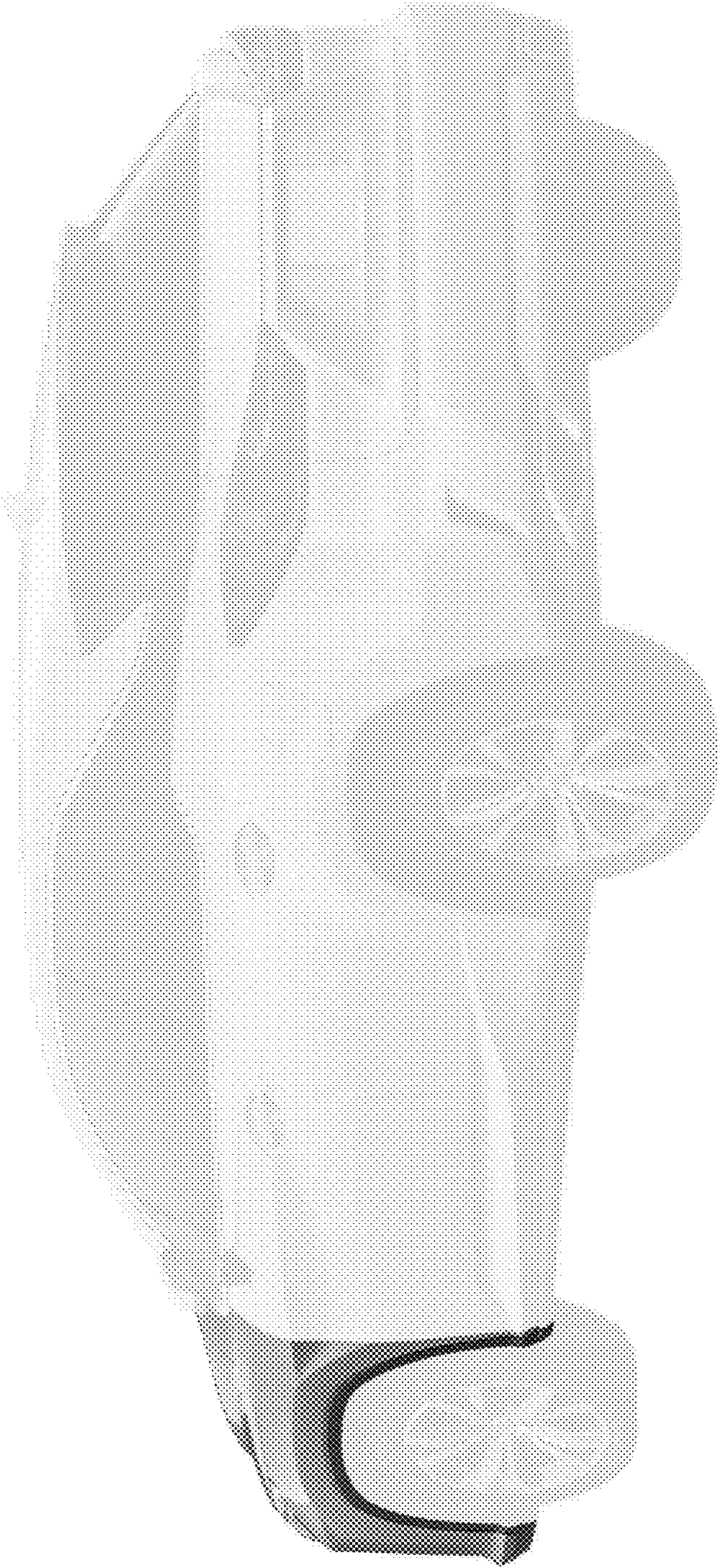

FIG. 2



FIG. 3

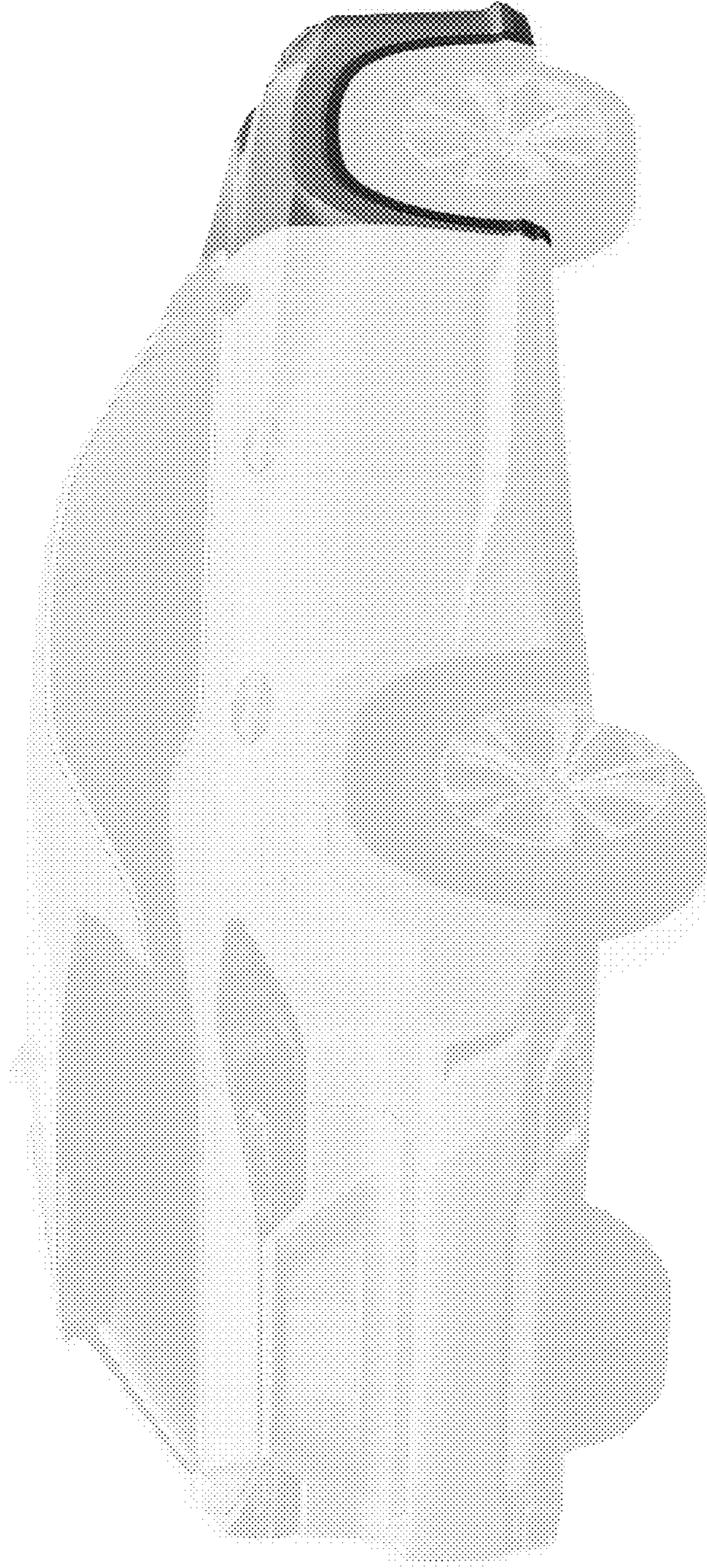

FIG. 4

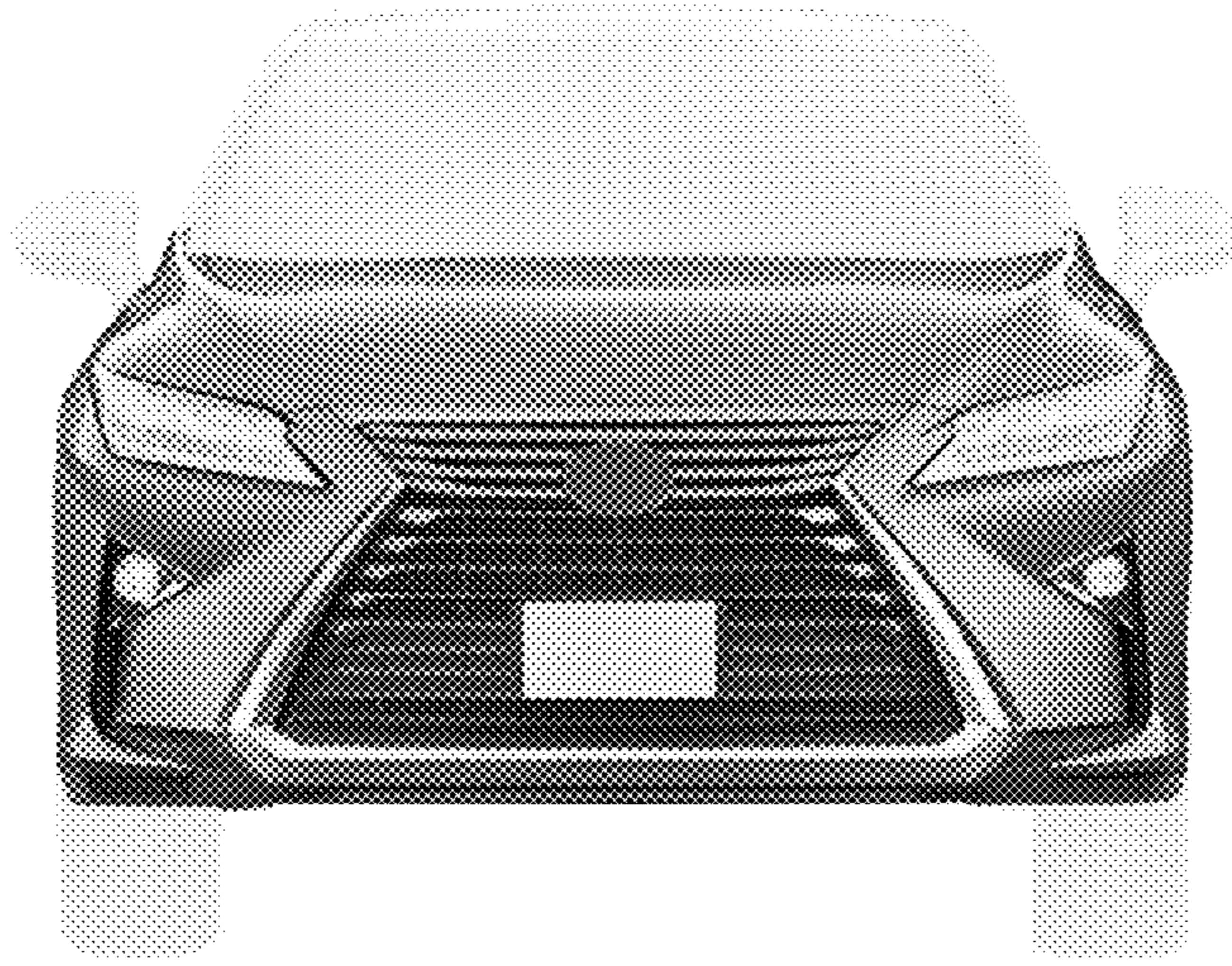

FIG. 5

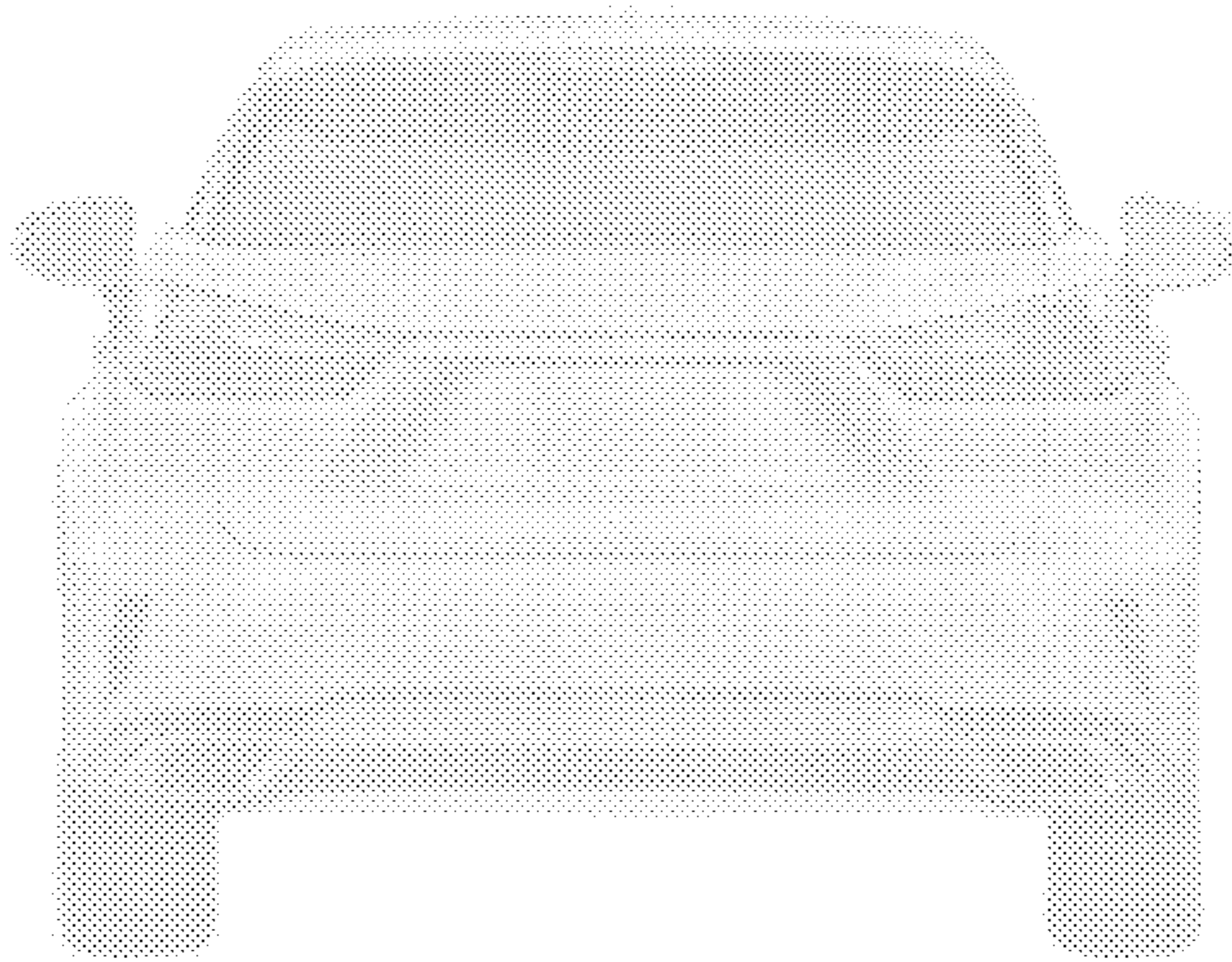

FIG. 6

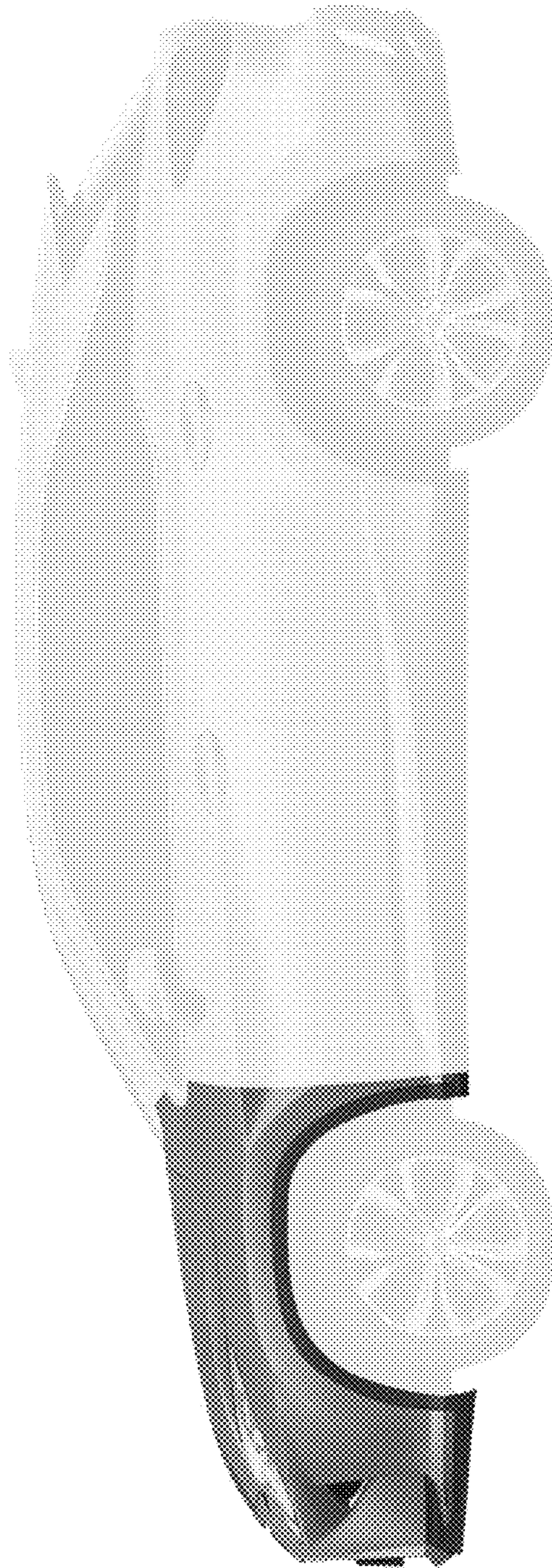

FIG. 7

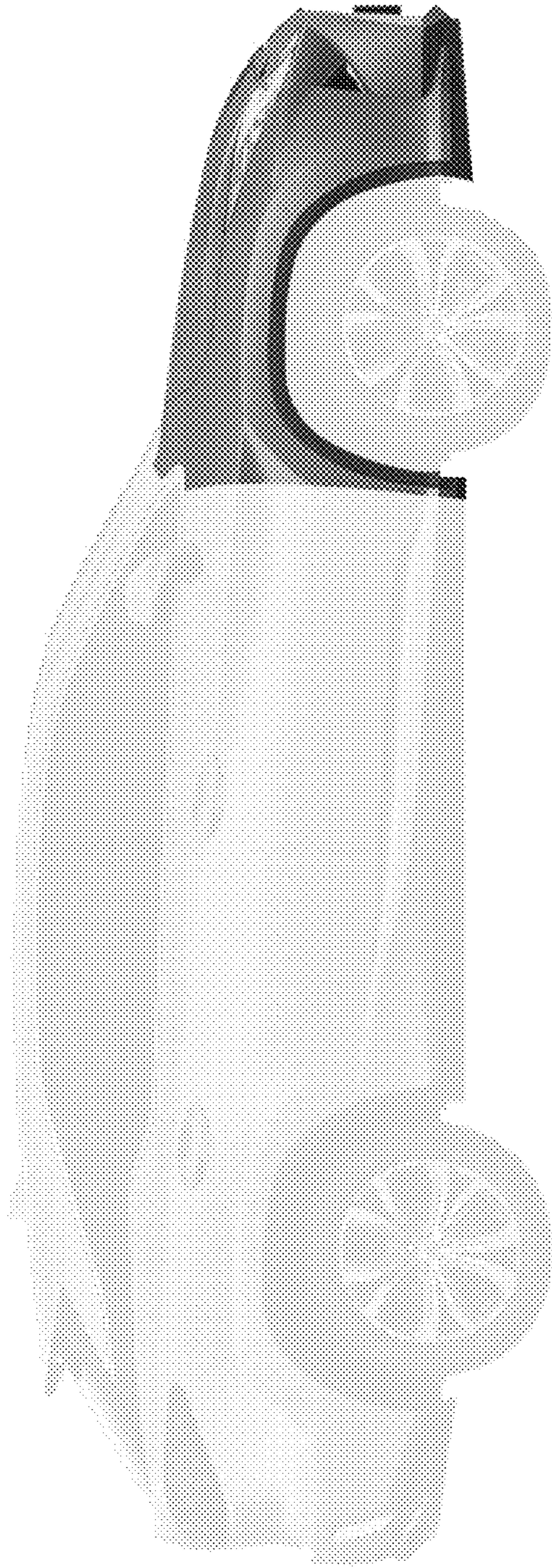

FIG. 8

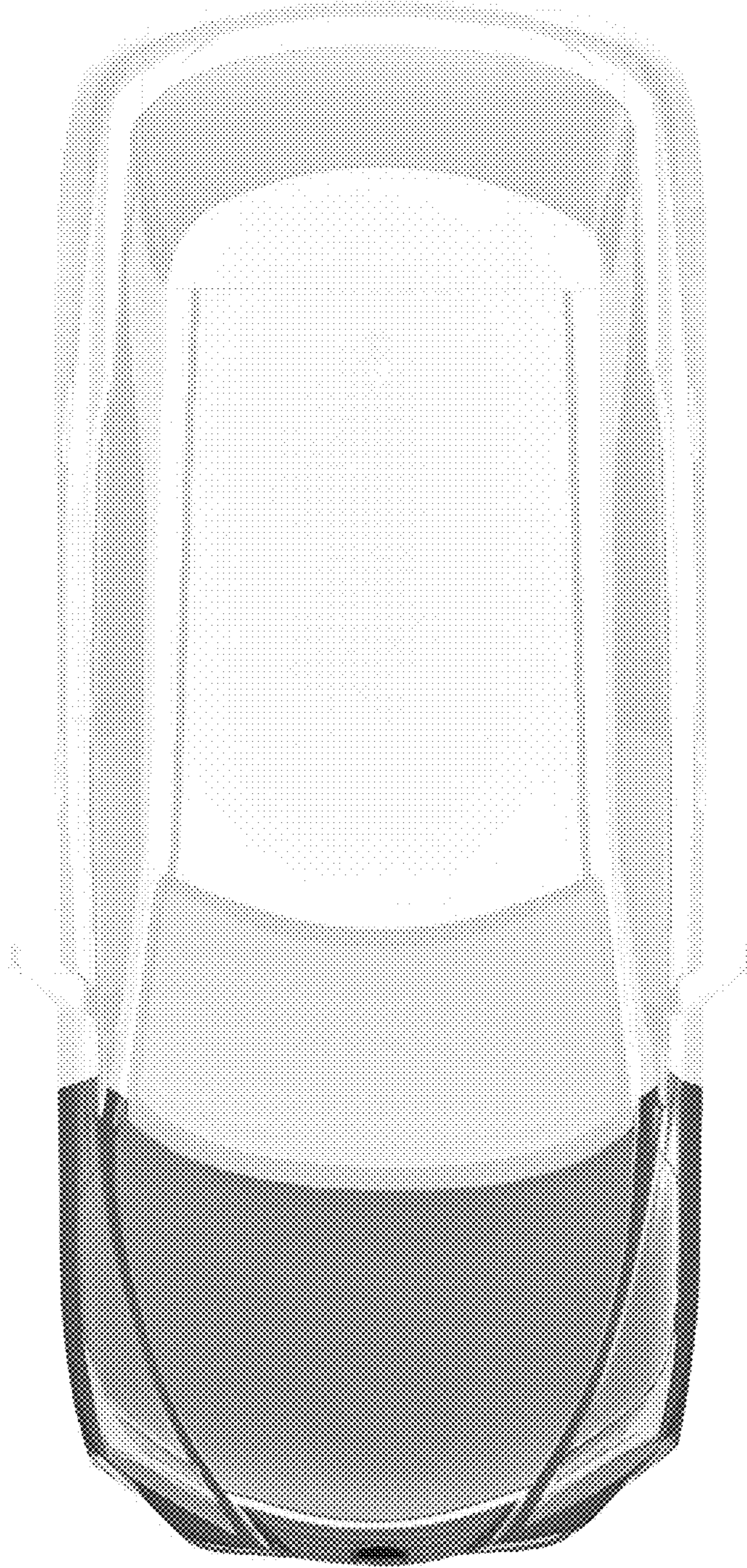

FIG. 9

UNITED STATES PATENT AND TRADEMARK OFFICE
CERTIFICATE OF CORRECTION

PATENT NO. : D779,393 S
APPLICATION NO. : 29/536827
DATED : February 21, 2017
INVENTOR(S) : Jin Won Kim et al.

Page 1 of 1

It is certified that error appears in the above-identified patent and that said Letters Patent is hereby corrected as shown below:

On the Title Page

On page 2, item [56], should read as follows:

Netcarshow.com; URL: http://www.netcarshow.com/lamborghini/2012-urus_concept/;
Model: Urus Concept (2012); Mfg.: Lamborghini; available on at least Apr. 8, 2014.

Netcarshow.com; URL: <http://www.netcarshow.com/lexus/2015-rc/>; Model: Lexus RC (2015); Mfg.:
Lexus; available on at least Apr. 8, 2014.

Signed and Sealed this
Eighth Day of August, 2017



Joseph Matal
*Performing the Functions and Duties of the
Under Secretary of Commerce for Intellectual Property and
Director of the United States Patent and Trademark Office*