



US00D779249S

(12) **United States Design Patent**  
**Cassaday**

(10) **Patent No.:** **US D779,249 S**

(45) **Date of Patent:** **\*\* Feb. 21, 2017**

(54) **BACK REST WITH LUMBAR SUPPORT**

(71) Applicant: **Terry Cassaday**, Mississauga (CA)

(72) Inventor: **Terry Cassaday**, Mississauga (CA)

(73) Assignee: **Ergo-Industrial Seating Systems Inc.**,  
Mississauga, Ontario (CA)

(\*\*) Term: **14 Years**

(21) Appl. No.: **29/524,760**

(22) Filed: **Apr. 23, 2015**

(51) **LOC (10) Cl.** ..... **06-01**

(52) **U.S. Cl.**  
USPC ..... **D6/716.4; D6/366**

(58) **Field of Classification Search**

USPC .... D6/334-336, 360-381, 716, 716.1-716.4  
CPC ..... A47C 1/02; A47C 1/03255; A47C 1/024;  
A47C 3/025; A47C 3/026; A47C  
7/02; A47C 7/022; A47C 7/028; A47C  
7/004; A47C 7/18; A47C 7/282; A47C  
7/40; A47C 7/402; A47C 7/44; A47C  
7/46; A47C 7/54; B60N 2/64; B60N 2/66  
See application file for complete search history.

(56) **References Cited**

**U.S. PATENT DOCUMENTS**

D517,820 S *	3/2006	Citterio	.....	D6/366
D613,085 S *	4/2010	Fujita	.....	D6/366
D613,086 S *	4/2010	Fujita	.....	D6/366
D613,087 S *	4/2010	Fujita	.....	D6/366
D652,223 S *	1/2012	Fujita	.....	D6/366
D663,129 S *	7/2012	Greutmann	.....	D6/366

(Continued)

*Primary Examiner* — Ricky Pham

(74) *Attorney, Agent, or Firm* — Eugene J. A. Gierczak

(57) **CLAIM**

The ornamental design for the “back rest with lumbar support,” as shown and described.

**DESCRIPTION**

FIG. 1 is a front perspective view of the back rest with lumbar support;

FIG. 2 is a rear perspective view of the back rest with lumbar support;

FIG. 3 is a left side elevational view of the back rest with lumbar support;

FIG. 4 is a from view of the back rest with lumbar support;

FIG. 5 is a right side elevational view of the back rest with lumbar support;

FIG. 6 is a rear view of the back rest with lumbar support;

FIG. 7 is a top view of the back rest with lumbar support;

FIG. 8 is a bottom view of the back rest with lumbar support;

FIG. 9 is a front perspective view of a first variant of the back rest;

FIG. 10 is a rear perspective view of a first variant of the back rest;

FIG. 11 is a left side elevational view of the first variant of the back rest;

FIG. 12 is a front view of the first variant of the back rest;

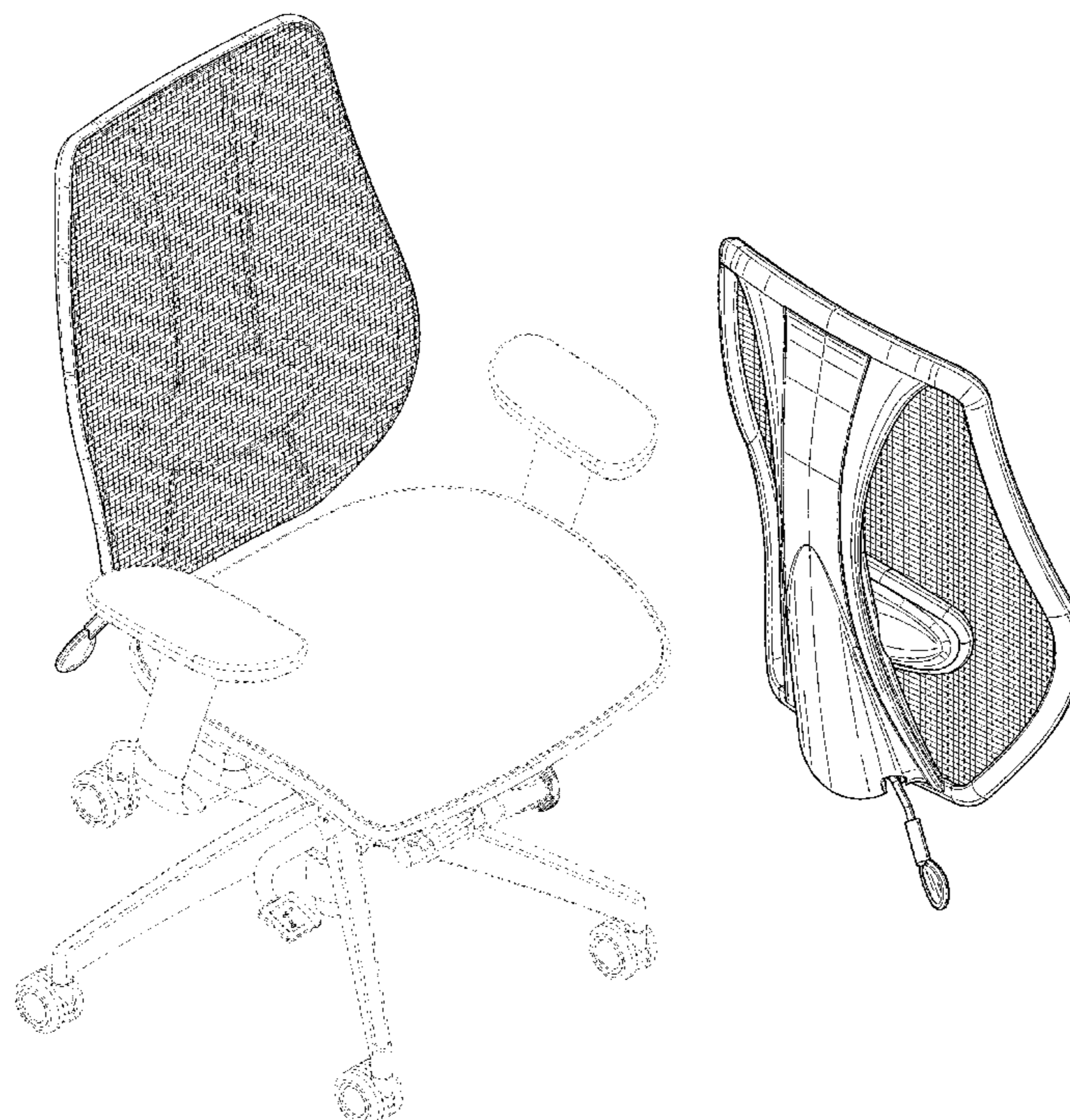
FIG. 13 is a right side elevational view of the first variant of the back rest;

FIG. 14 is a rear view of the first variant of the back rest;

FIG. 15 is a top view of the first variant of the back rest; and,

FIG. 16 is a bottom view of the first variant of the back rest. The broken lines shown in the drawings are for illustrative purposes only and form no part of the claimed design.

**1 Claim, 10 Drawing Sheets**



(56)

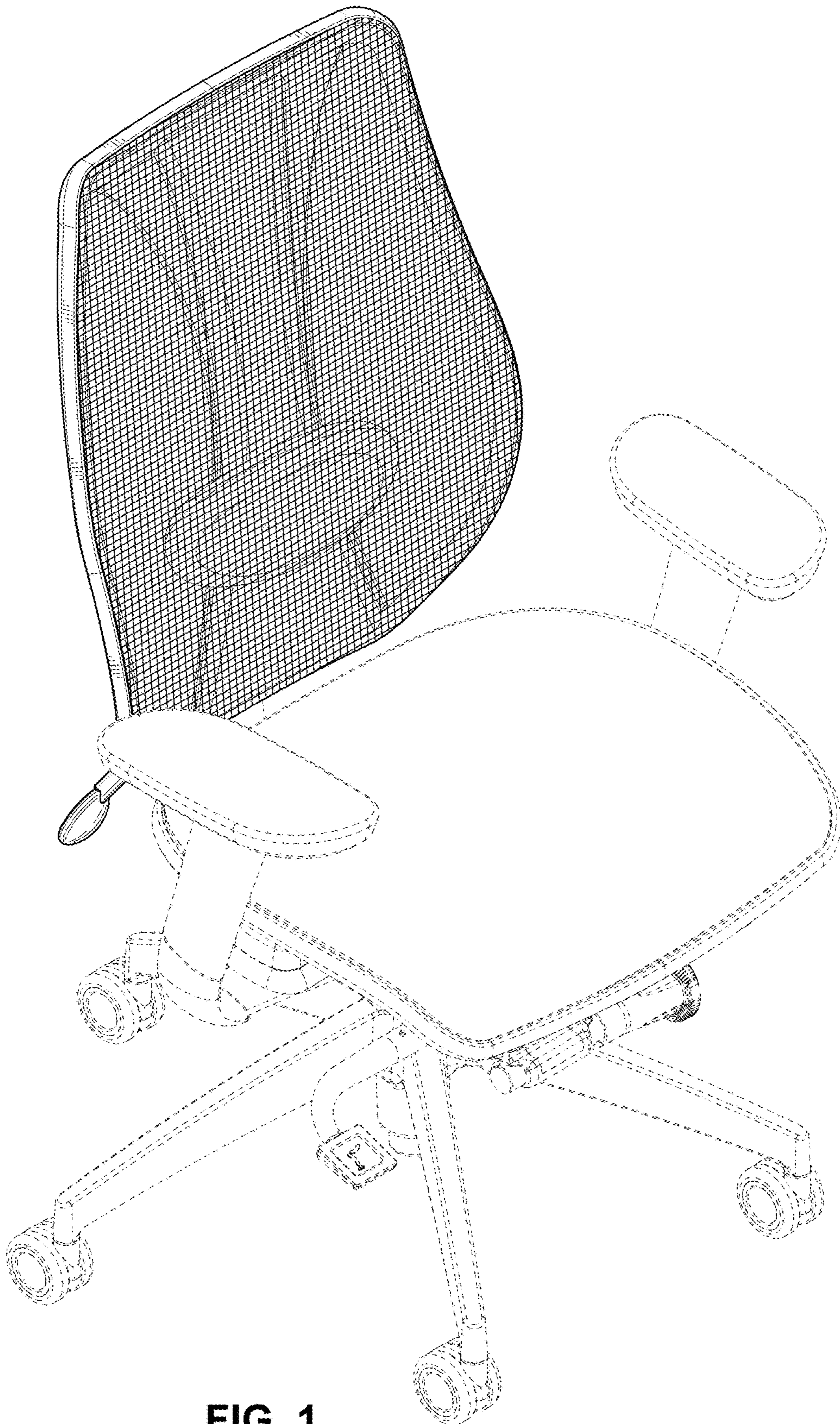
**References Cited**

U.S. PATENT DOCUMENTS

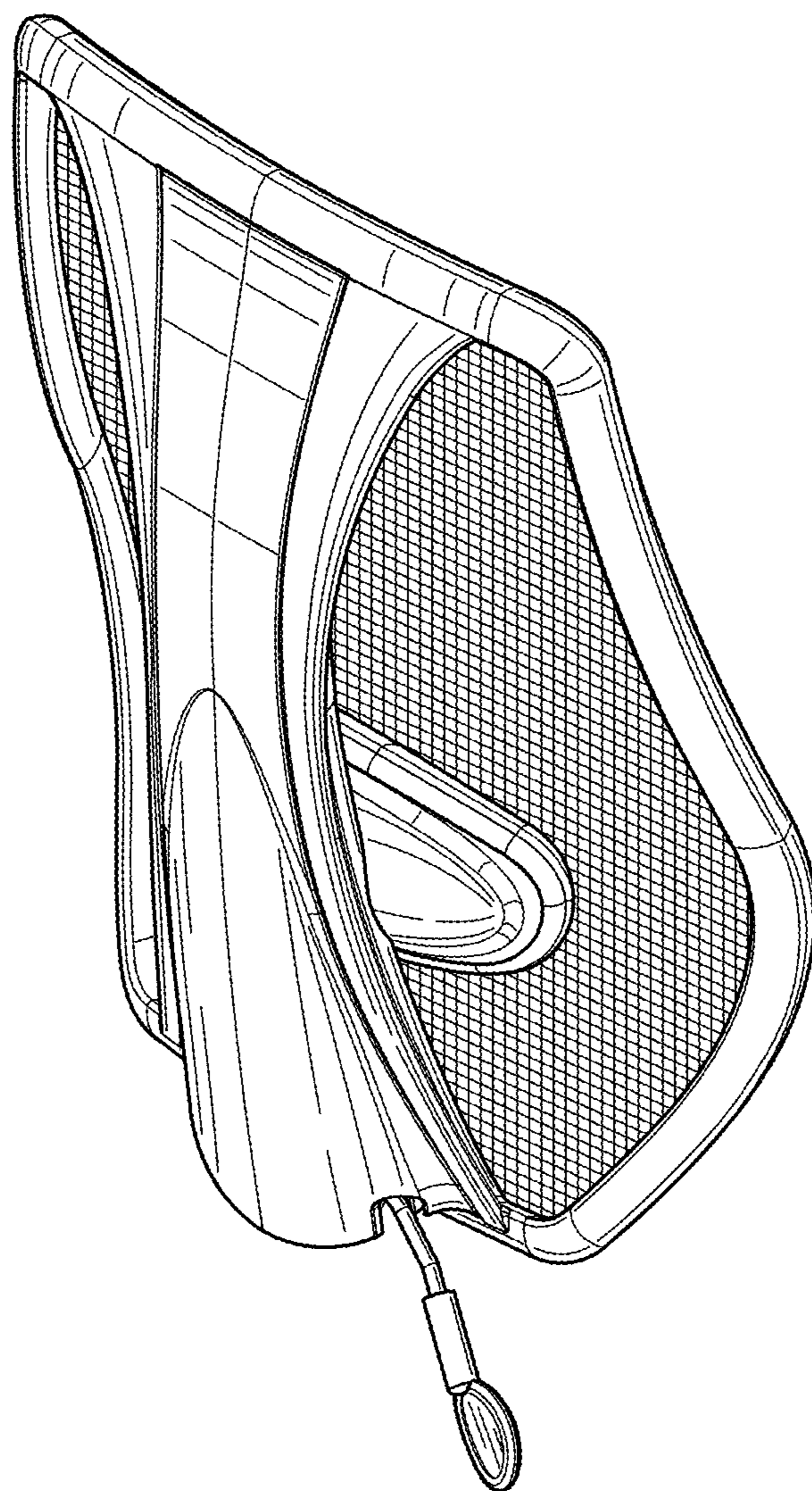
D683,150	S	*	5/2013	Smith	.....	D6/366
D683,151	S	*	5/2013	Smith	.....	D6/366
D688,499	S	*	8/2013	Smith	.....	D6/716
D689,313	S	*	9/2013	Smith	.....	D6/716
D690,146	S	*	9/2013	Smith	.....	D6/716
D690,547	S	*	10/2013	Smith	.....	D6/716.4
D694,537	S	*	12/2013	Smith	.....	D6/366
D694,538	S	*	12/2013	Smith	.....	D6/366
D694,539	S	*	12/2013	Smith	.....	D6/366
D695,538	S	*	12/2013	Geelen	.....	D6/366
D697,726	S	*	1/2014	Smith	.....	D6/366
D697,727	S	*	1/2014	Smith	.....	D6/366
D697,728	S	*	1/2014	Smith	.....	D6/366
D697,730	S	*	1/2014	Smith	.....	D6/366
D699,958	S	*	2/2014	Smith	.....	D6/366
D701,053	S	*	3/2014	Smith	.....	D6/366
D701,068	S	*	3/2014	Usumoto	.....	D6/366
D733,445	S	*	7/2015	Izawa	.....	D6/366
D742,676	S	*	11/2015	Smith	.....	D6/716
D742,677	S	*	11/2015	Smith	.....	D6/716

\* cited by examiner



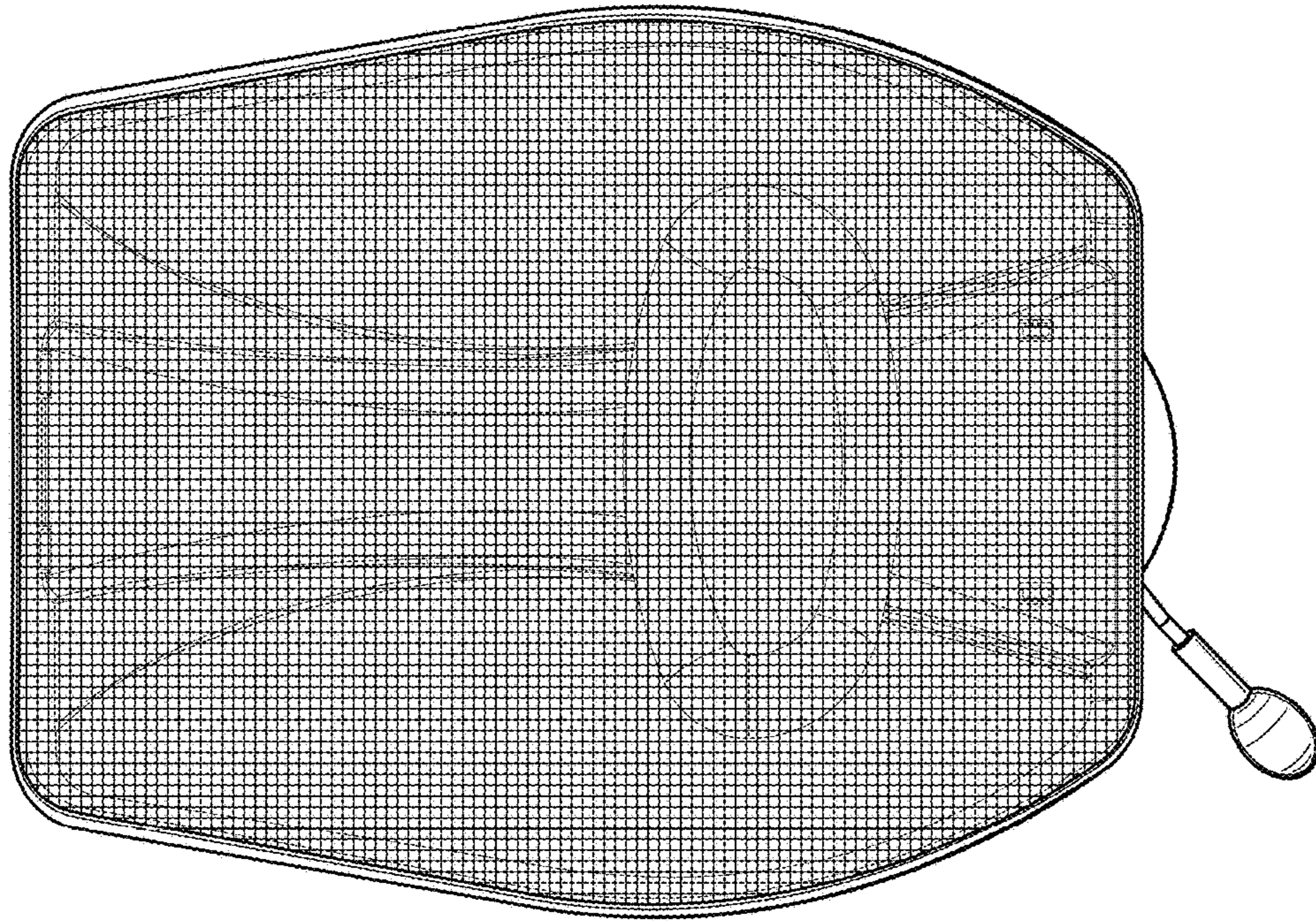


**FIG. 1**

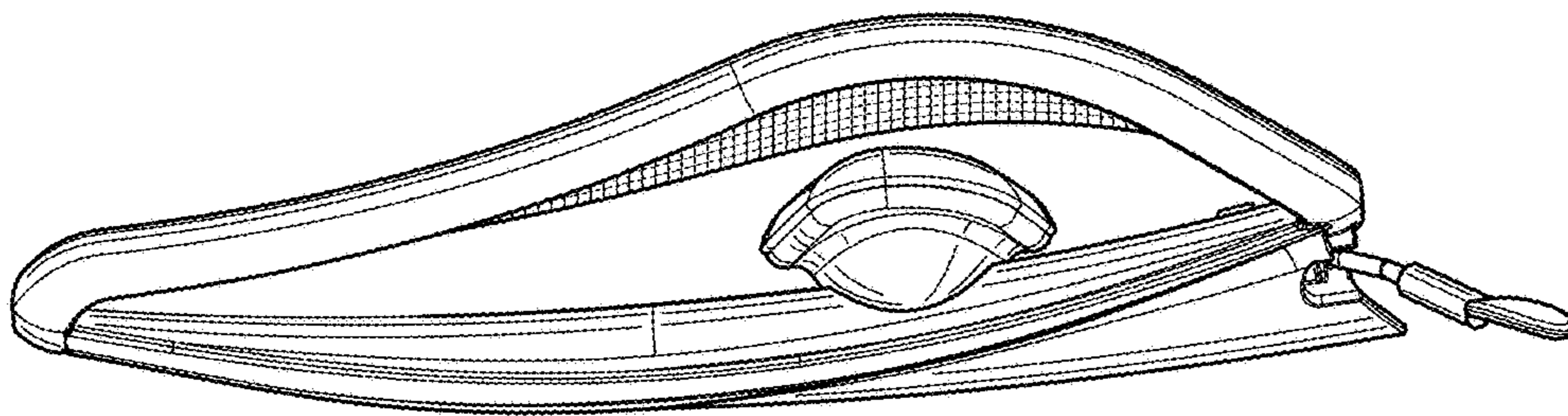


**FIG. 2**





**FIG. 4**



**FIG. 3**



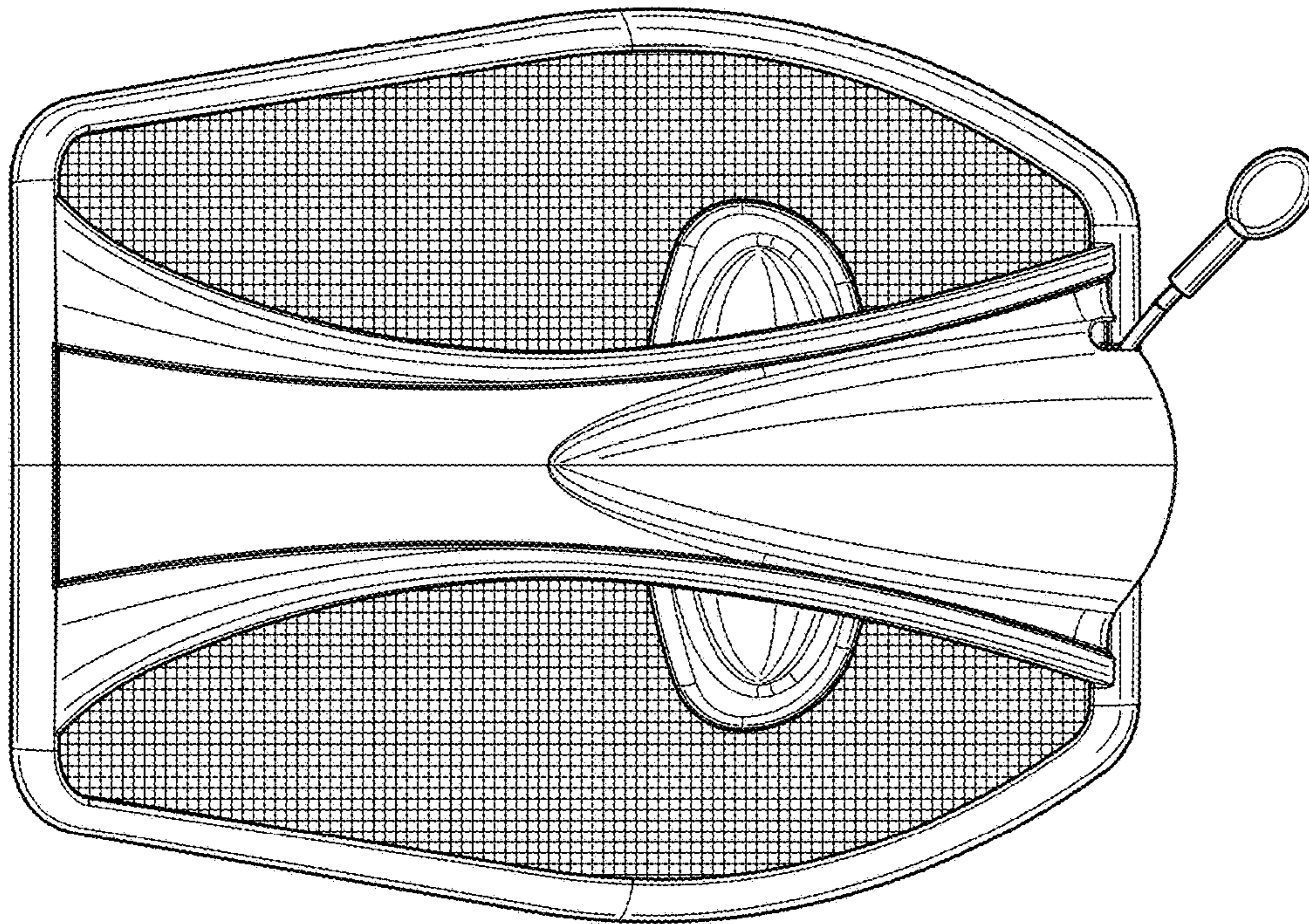


FIG. 6

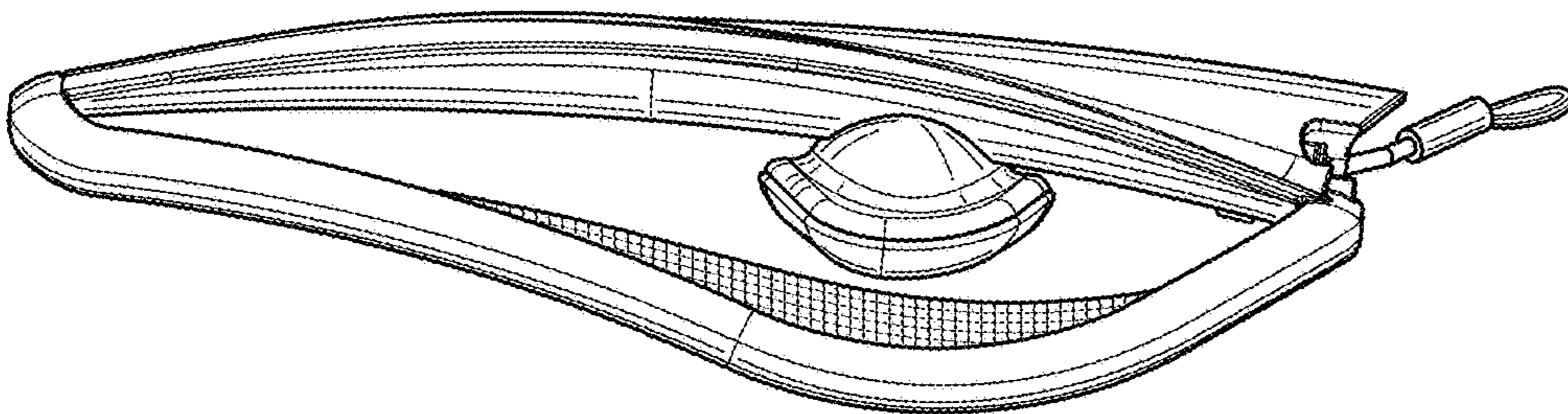


FIG. 5

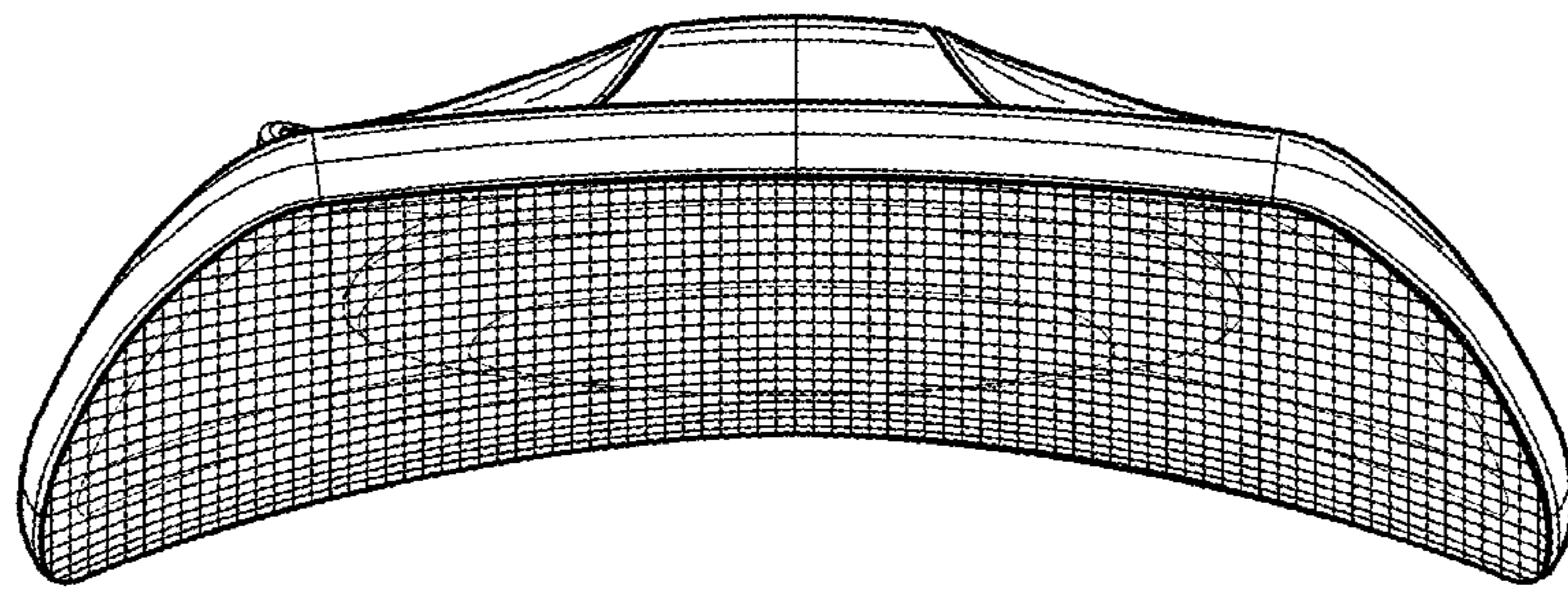


FIG. 7

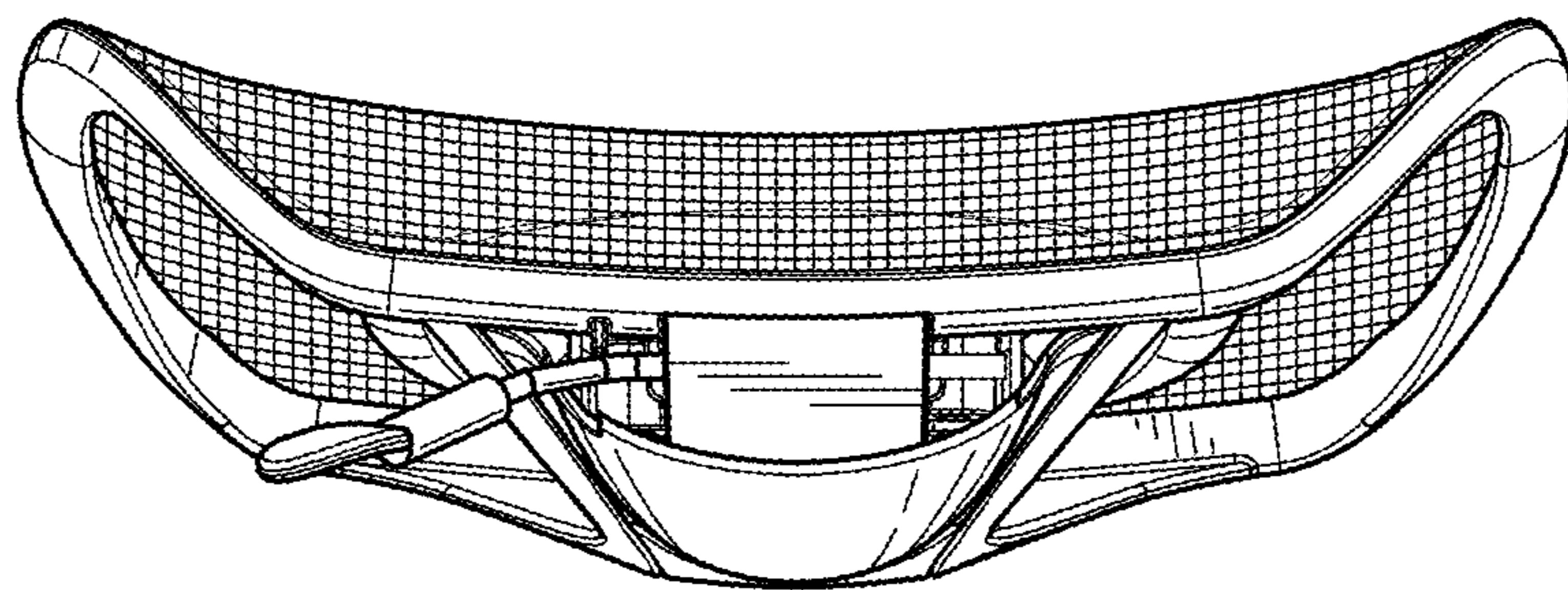
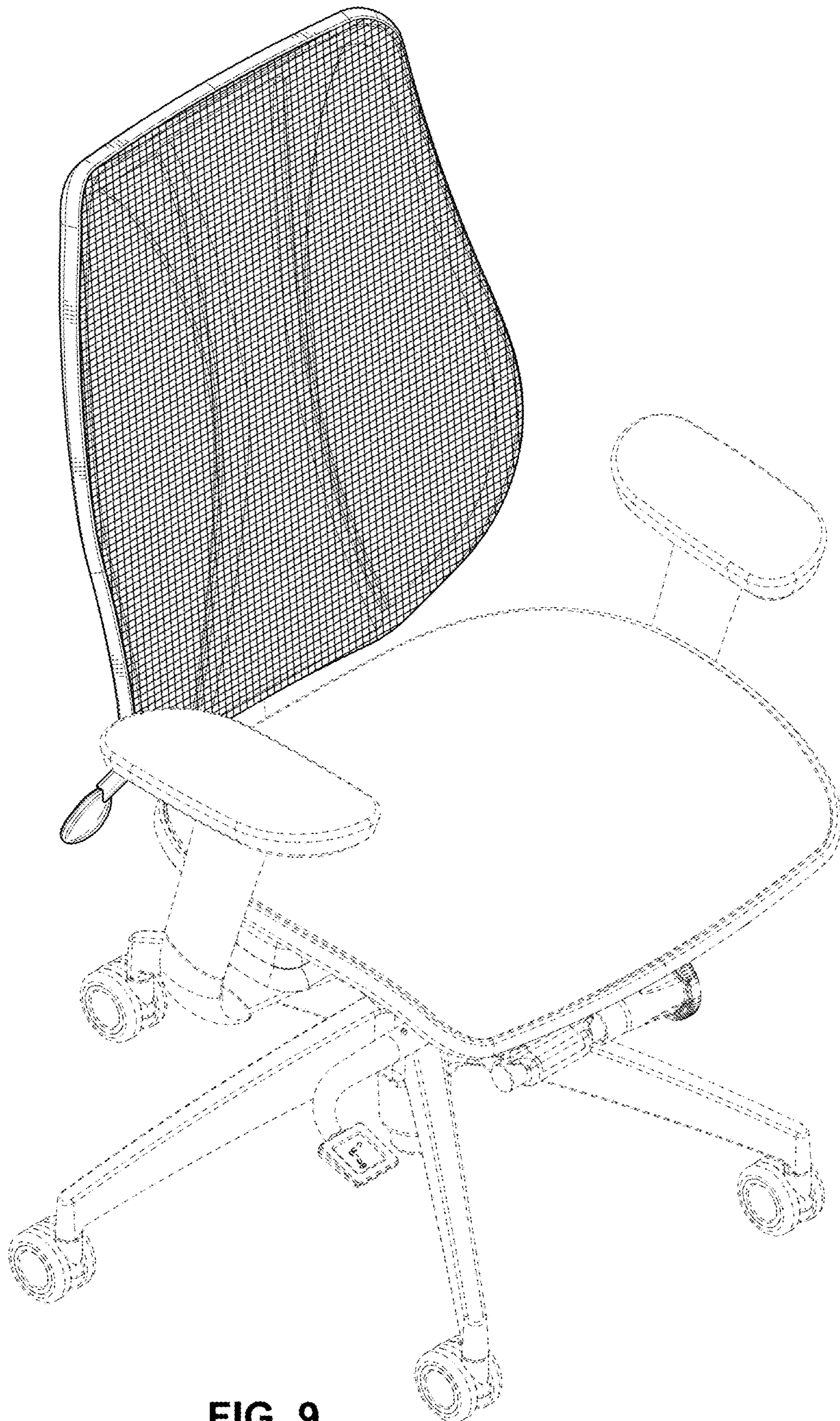


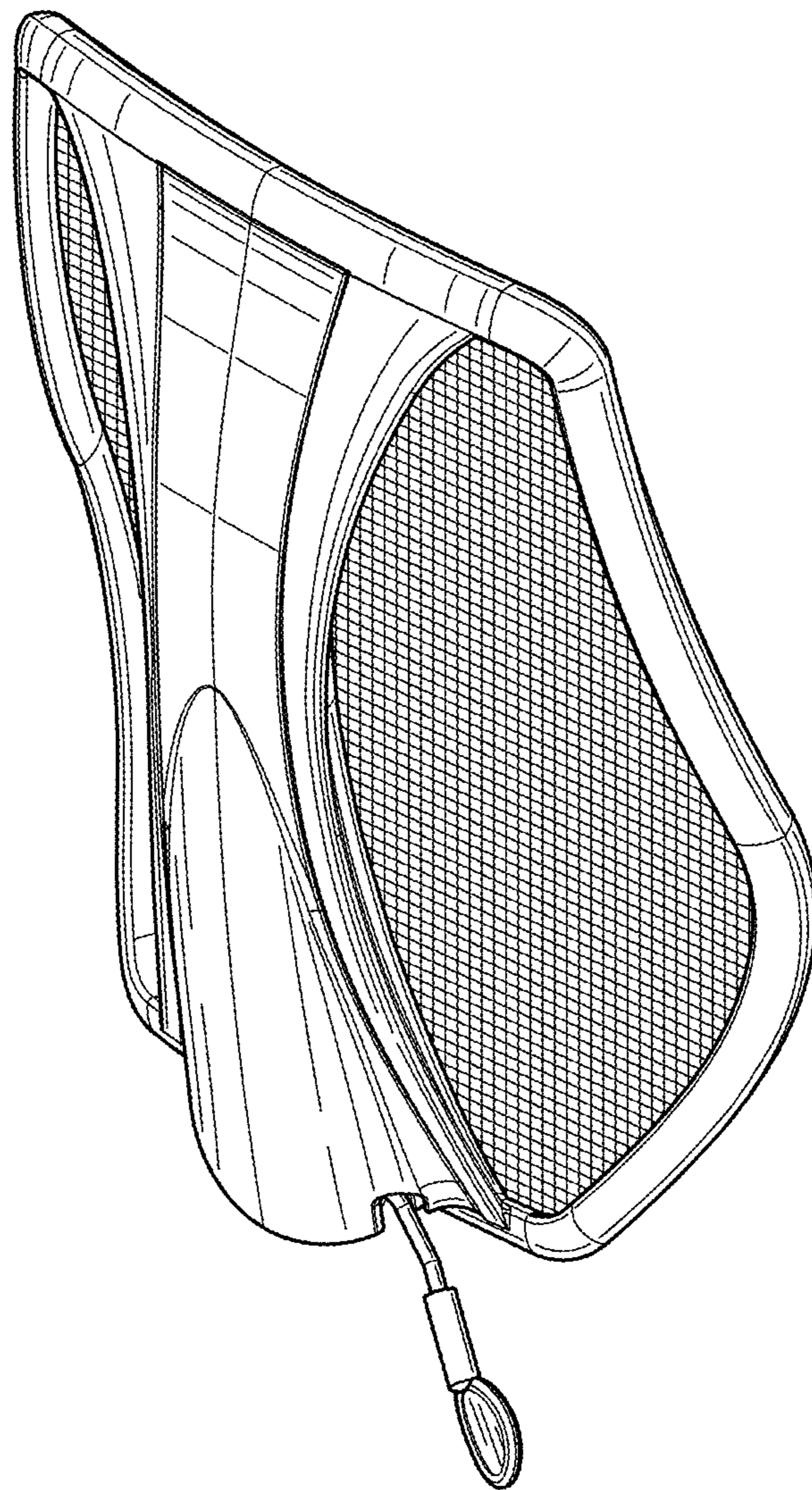
FIG. 8



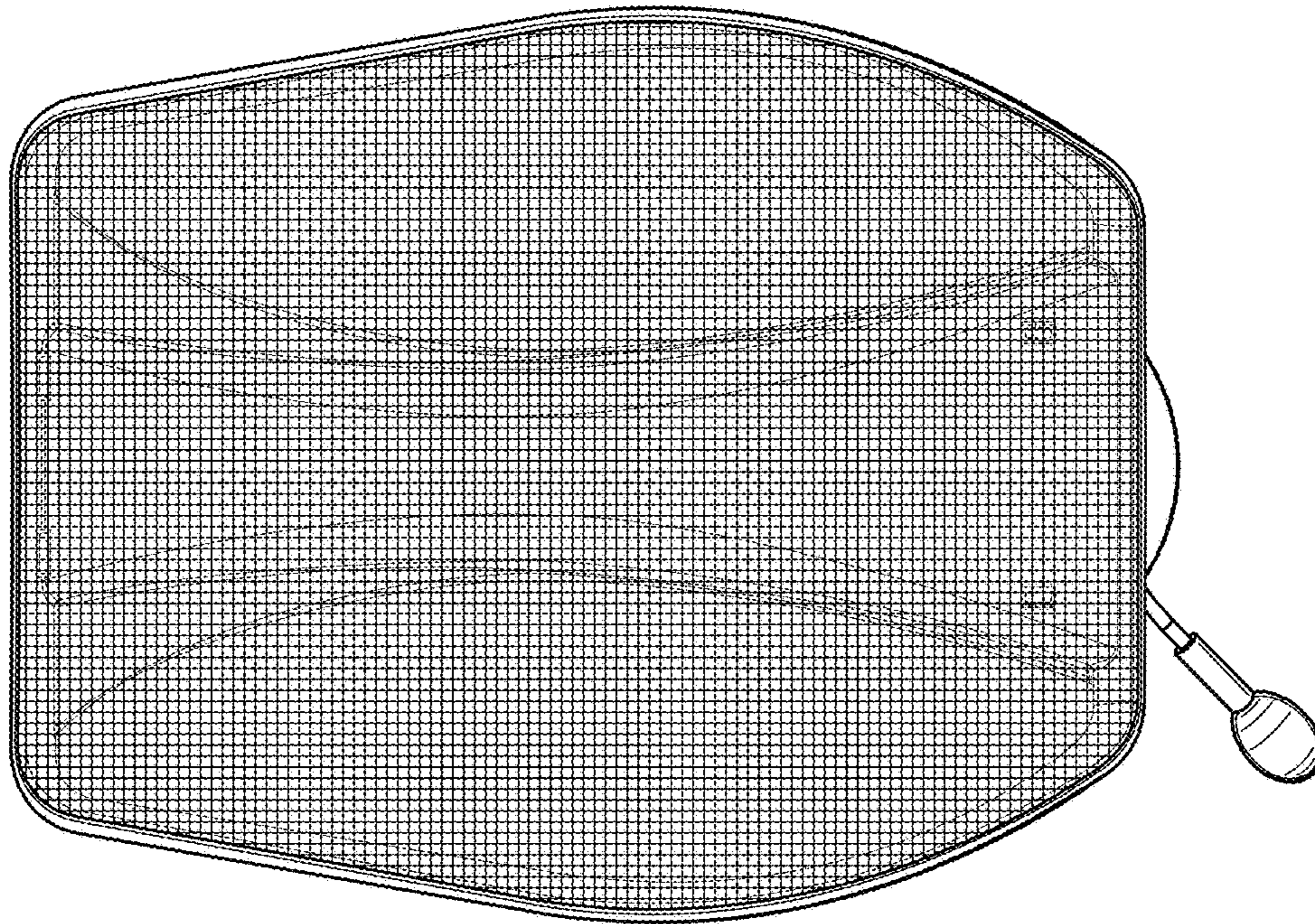


**FIG. 9**

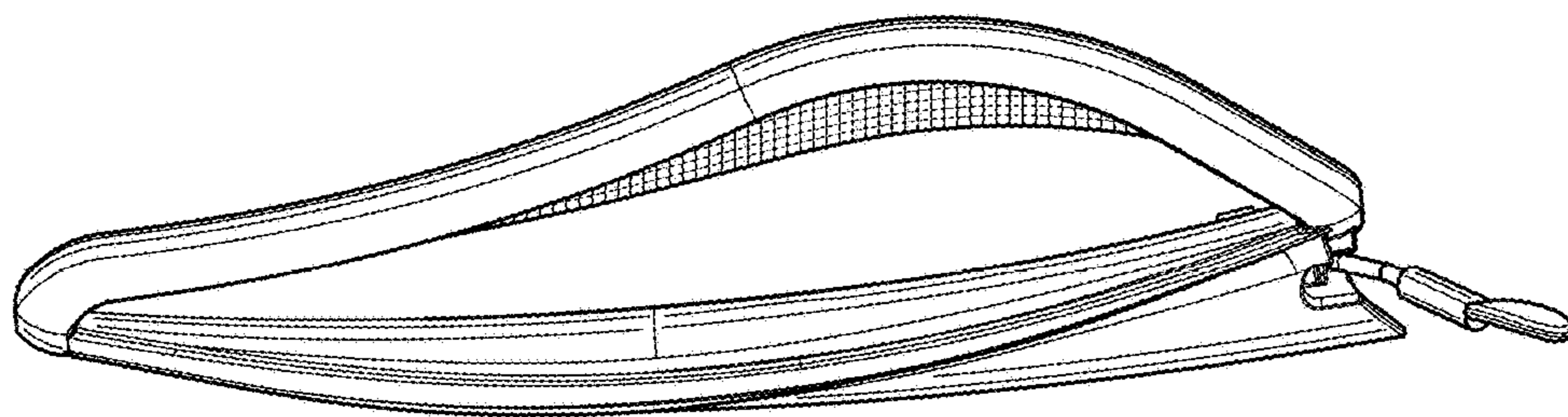




**FIG. 10**



**FIG. 12**



**FIG. 11**



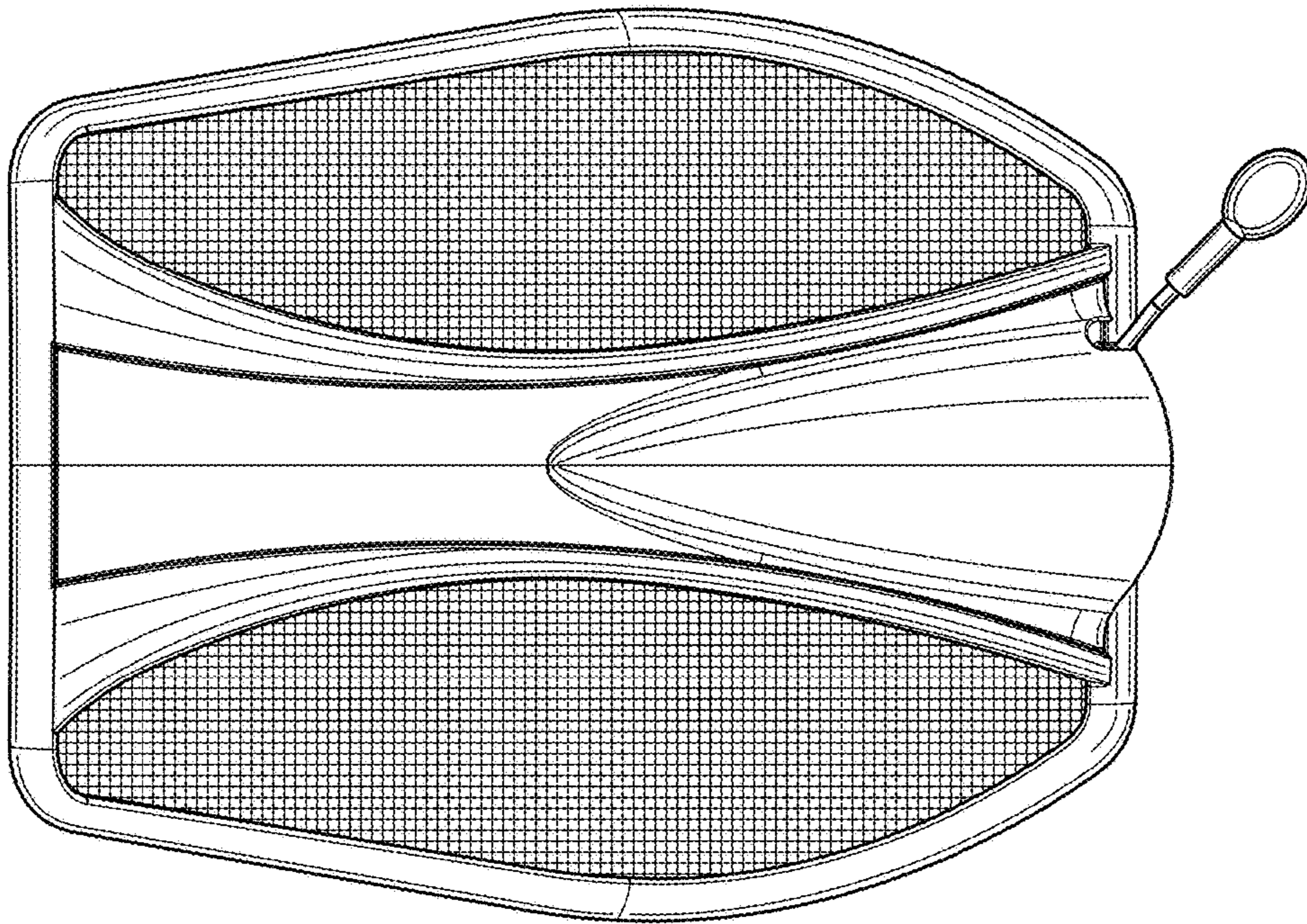


FIG. 14

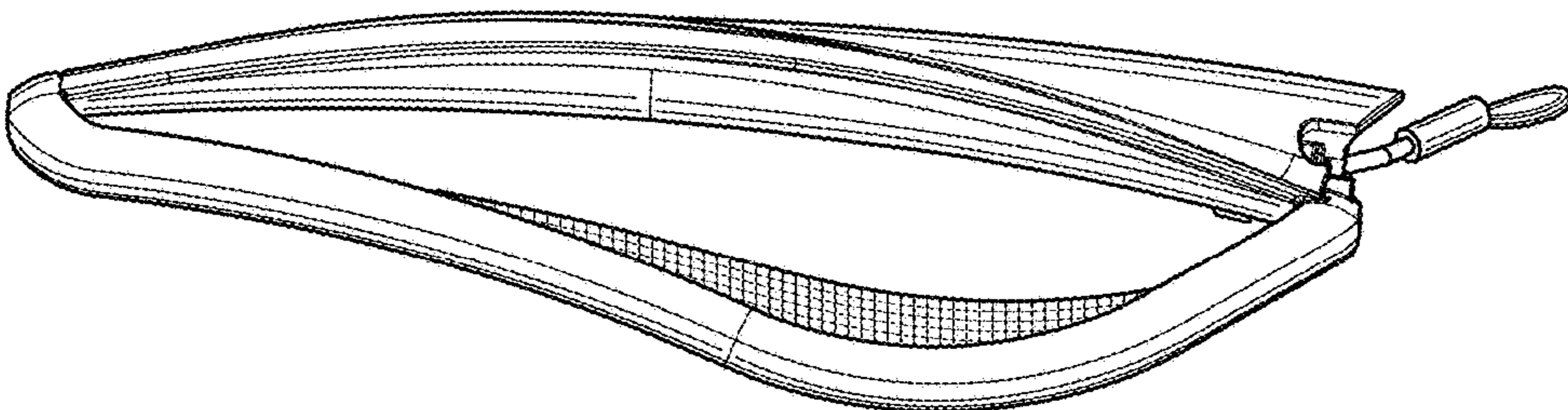


FIG. 13

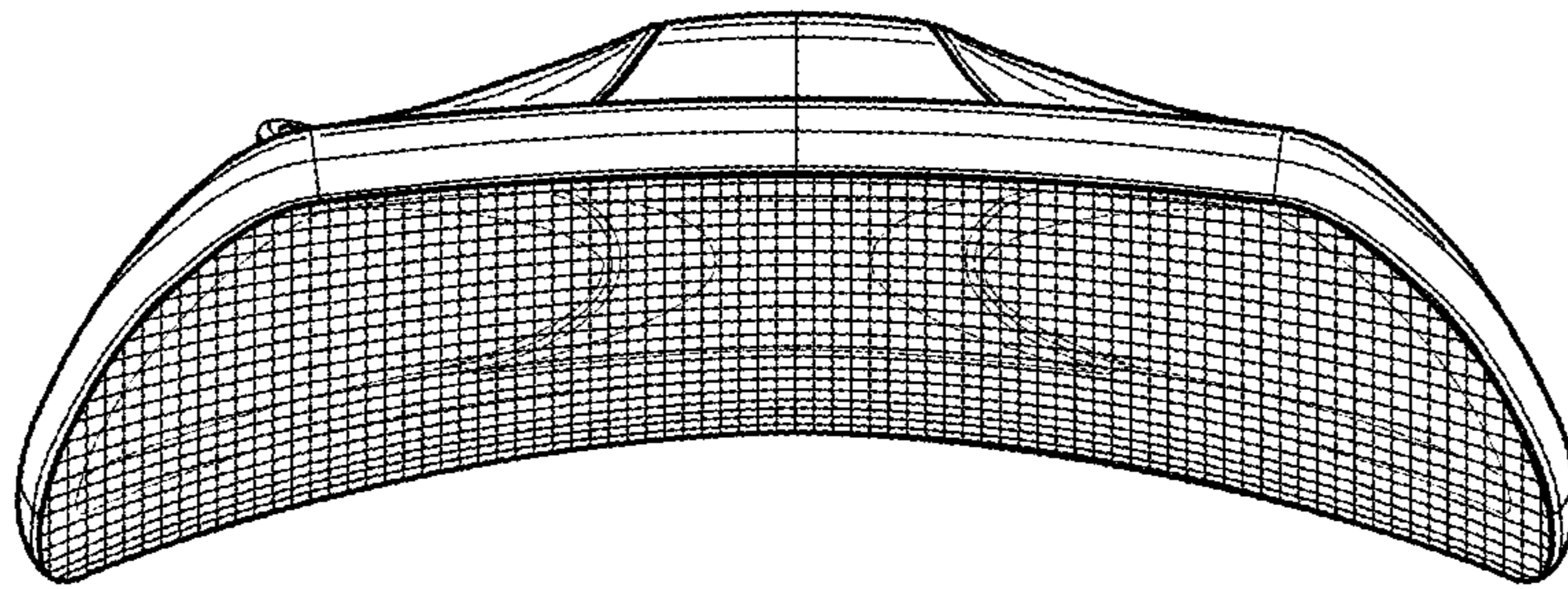


FIG. 15

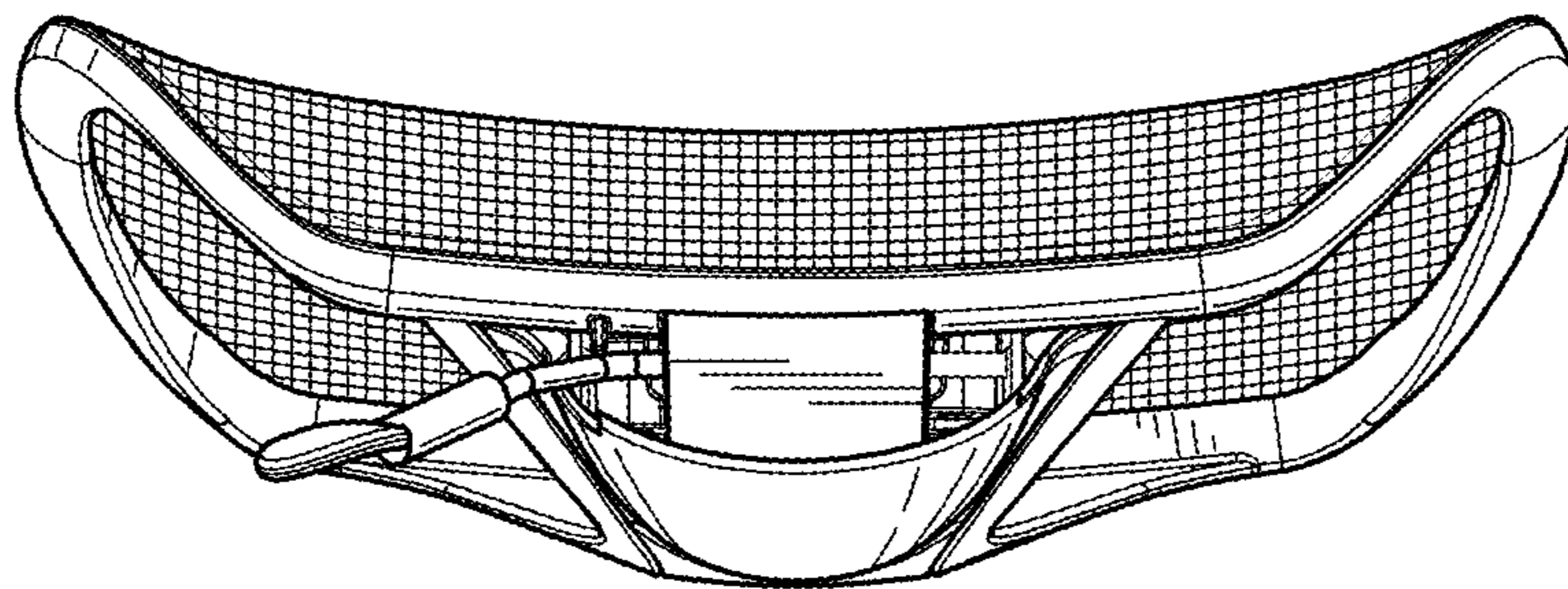


FIG. 16