



US00D779169S

(12) **United States Design Patent** (10) **Patent No.:** **US D779,169 S**
Denn (45) **Date of Patent:** **** Feb. 21, 2017**

(54) **FOOTBALL PLAYER NOVELTY HAT**
(71) Applicant: **ELSO Exchange, LLC**, Westford, MA (US)
(72) Inventor: **Sarah Denn**, Westford, MA (US)
(**) Term: **15 Years**
(21) Appl. No.: **29/538,152**
(22) Filed: **Sep. 1, 2015**
(51) **LOC (10) Cl.** **02-03**
(52) **U.S. Cl.**
USPC **D2/869**
(58) **Field of Classification Search**
USPC D2/741, 865, 866, 868, 869, 870, 871, D2/872, 873, 878, 885, 888, 891, 895
CPC A41D 11/00; A42B 1/00; A42B 1/004; A42B 1/04; A42B 1/066; A42B 1/24; A44B 9/00
See application file for complete search history.

5,561,864 A * 10/1996 DeMars A63H 3/36 2/209.13
D389,291 S * 1/1998 Sterrett D2/865
D422,398 S * 4/2000 Jones D2/869
D430,386 S * 9/2000 Necatera D2/869
D454,678 S * 3/2002 Graves D2/872
D520,216 S * 5/2006 Cope D2/888
D589,684 S * 4/2009 Knab D2/869
D619,761 S * 7/2010 Guerrero D28/41
D624,286 S * 9/2010 Hall D2/878
D664,741 S * 8/2012 Scott D2/871
D701,678 S * 4/2014 Burnett D2/870
D731,156 S * 6/2015 Glaser D2/872
D735,448 S * 8/2015 Caird D2/870

OTHER PUBLICATIONS

US Trademark Application #86525484 for "Els0 Exchange," filed Feb. 5, 2015 by Elso Exchanged. Commerce Date: Oct. 24, 2015. Publication Date: Jun. 23, 2015. Retrieved on Aug. 9, 2016.*

(Continued)

Primary Examiner — Karen E. Eldridge Powers
Assistant Examiner — Jasmine Mlinarcik
(74) *Attorney, Agent, or Firm* — Bay State IP, LLC

(56) **References Cited**

U.S. PATENT DOCUMENTS

D62,860 S * 8/1923 Corenson D2/865
D156,143 S * 11/1949 Maupin D2/869
D188,652 S * 8/1960 Laganella D2/741
D189,181 S * 11/1960 Geib D2/868
4,218,780 A * 8/1980 Growe A42B 1/004 2/171
4,268,918 A * 5/1981 Lee A42B 1/004 2/172
4,543,669 A * 10/1985 Katz A41D 11/00 2/84
D287,421 S * 12/1986 Scaggs D2/869
D311,089 S * 10/1990 Guevara D2/871
D336,357 S * 6/1993 Gravante D2/872
D366,751 S * 2/1996 Gravante D2/872

(57) **CLAIM**

I claim the ornamental design for a football player novelty hat, as shown and described.

DESCRIPTION

FIG. 1 is a front elevation view of a football player novelty hat showing my design;
FIG. 2 is a back elevation view thereof;
FIG. 3 is a right side elevation view thereof;
FIG. 4 is a left side elevation view thereof;
FIG. 5 is a top plan view thereof; and,
FIG. 6 is a bottom perspective view thereof.

1 Claim, 3 Drawing Sheets

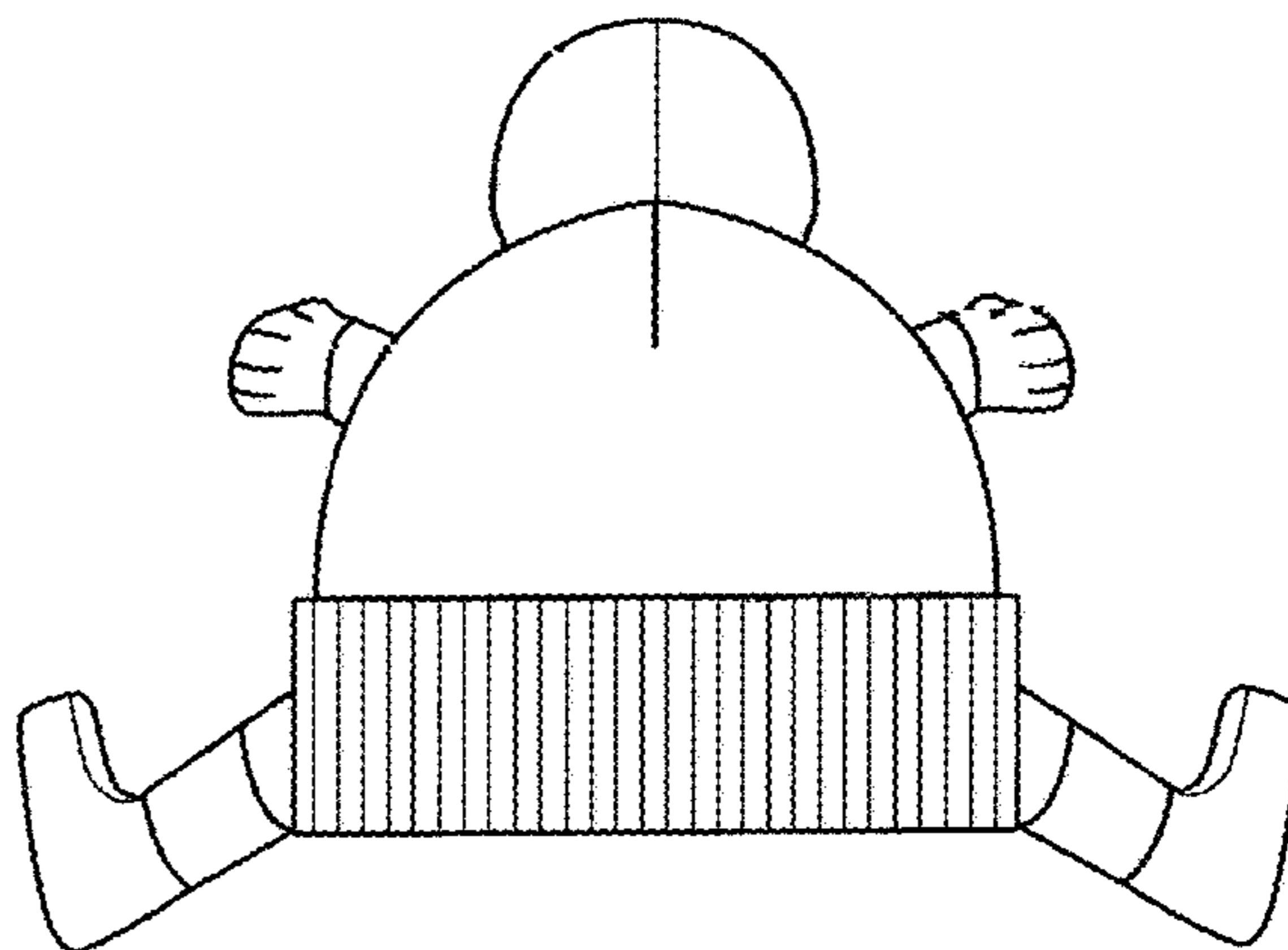
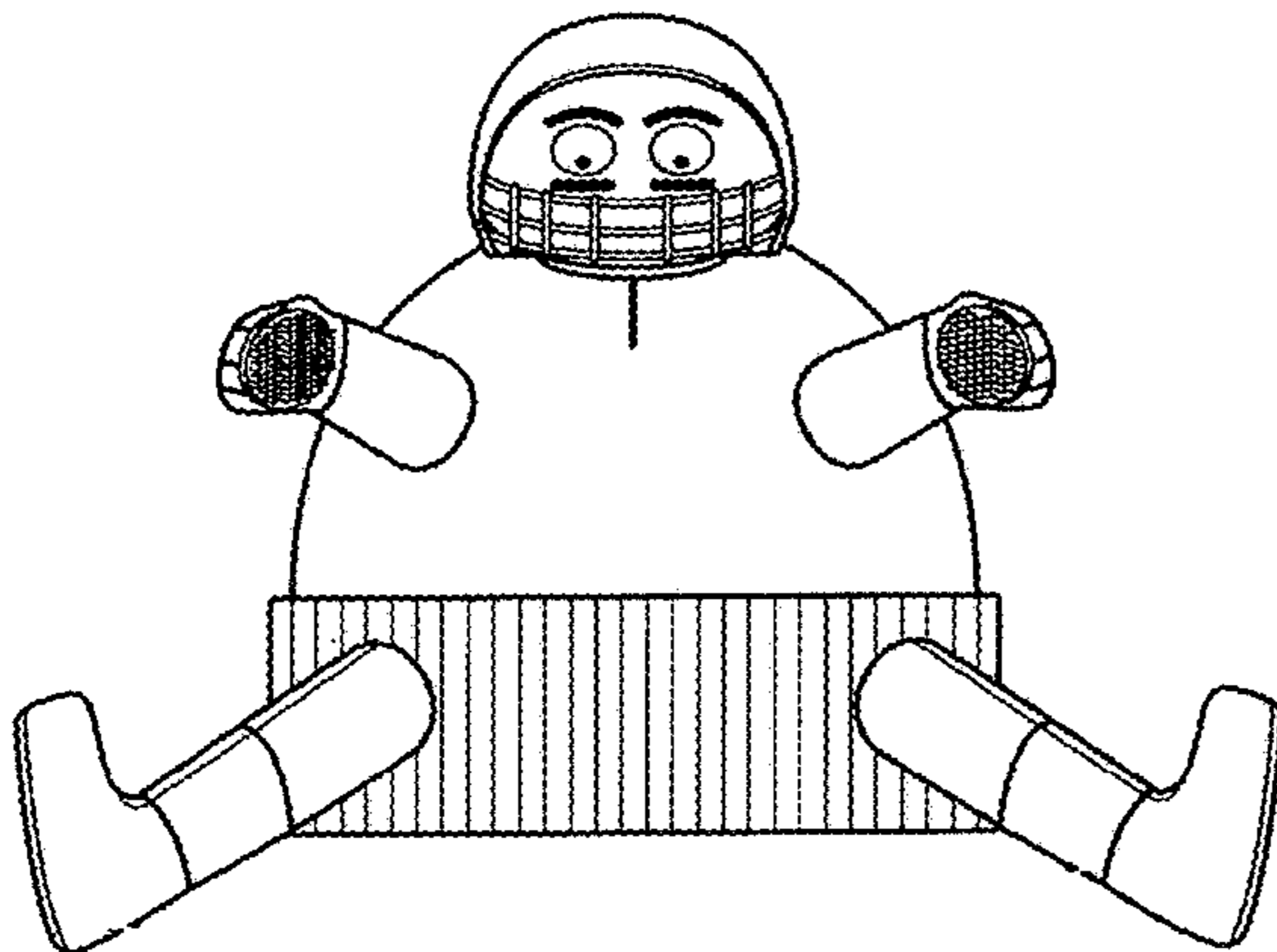

(56)

References Cited

OTHER PUBLICATIONS

Sarah Denn's Profile, [on-line]; [joined Etsy.com on the Internet on Dec. 21, 2015.]; [retrieved from the Internet on Aug. 9, 2016]; URL: <https://www.etsy.com/people/sarandenn2?ref=pr_profile>. (1 page).*

* cited by examiner

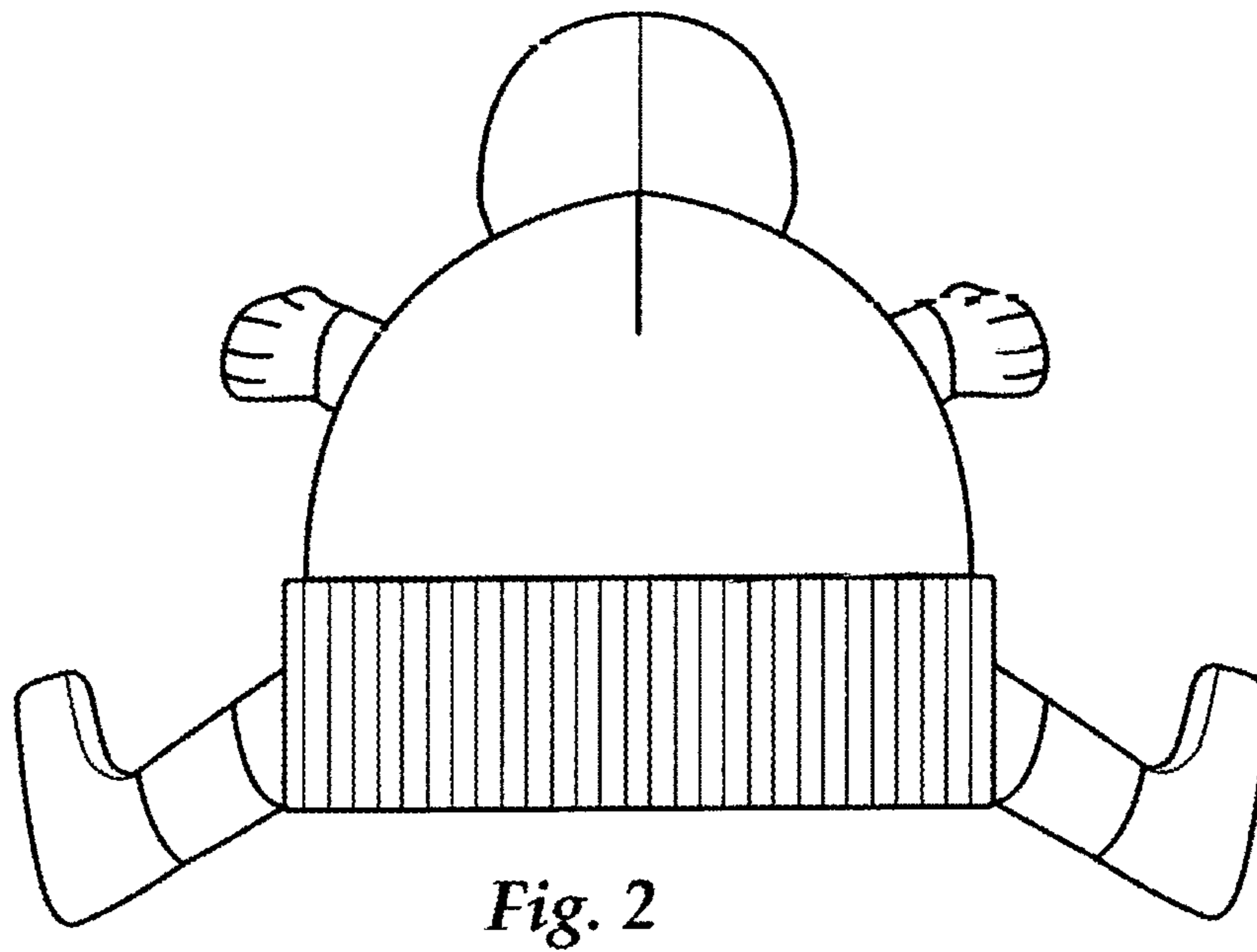
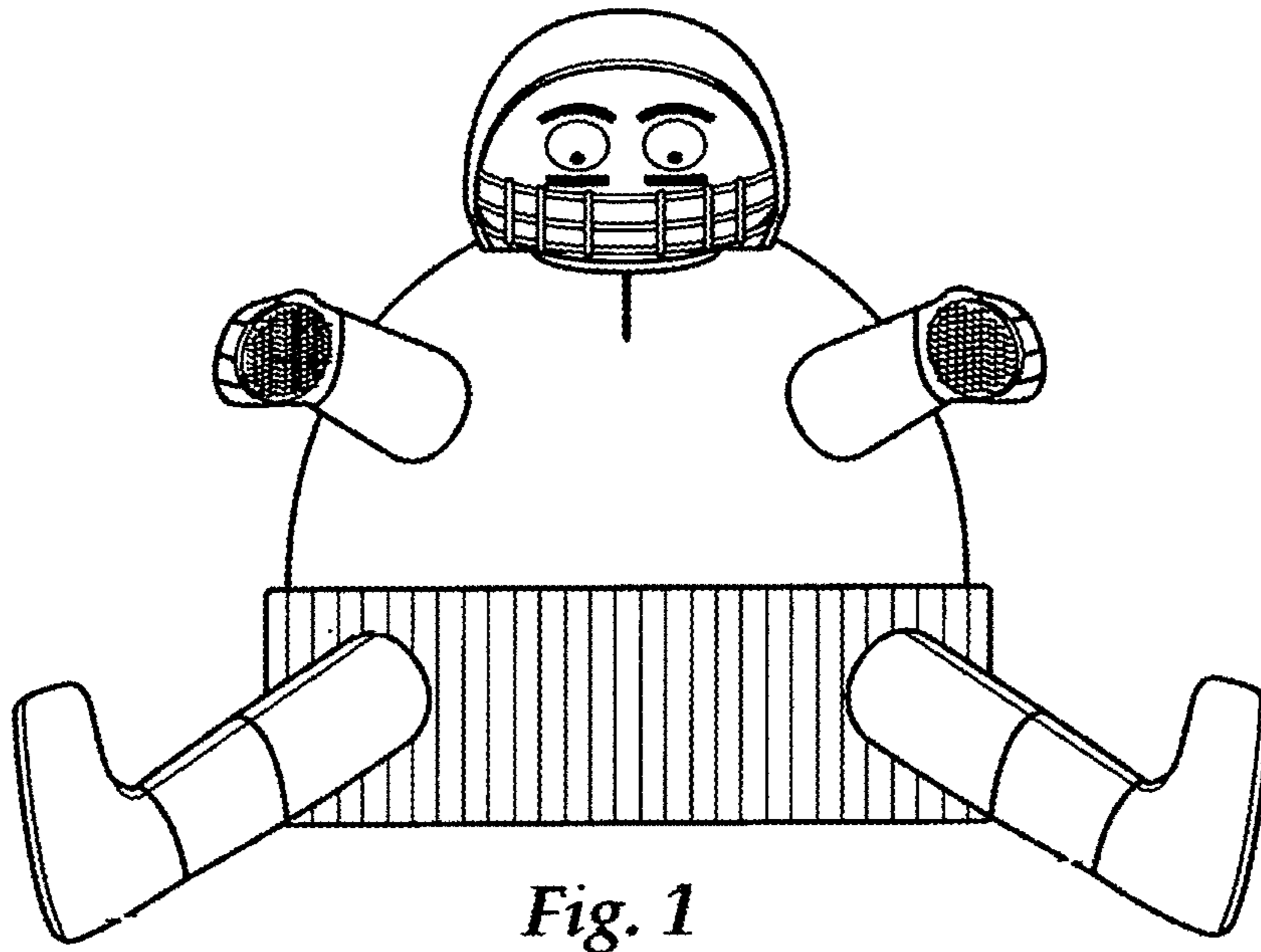

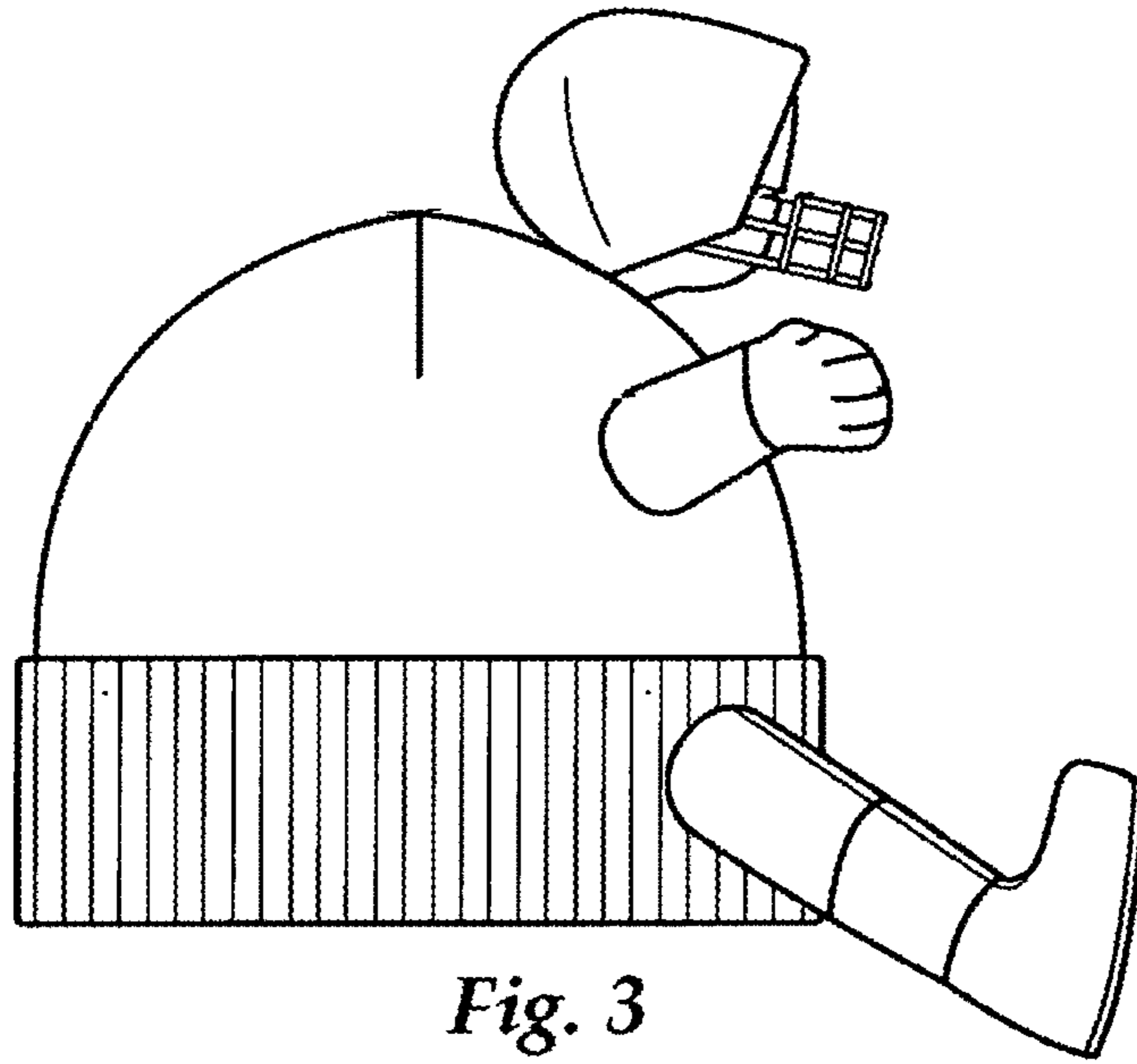

Fig. 3

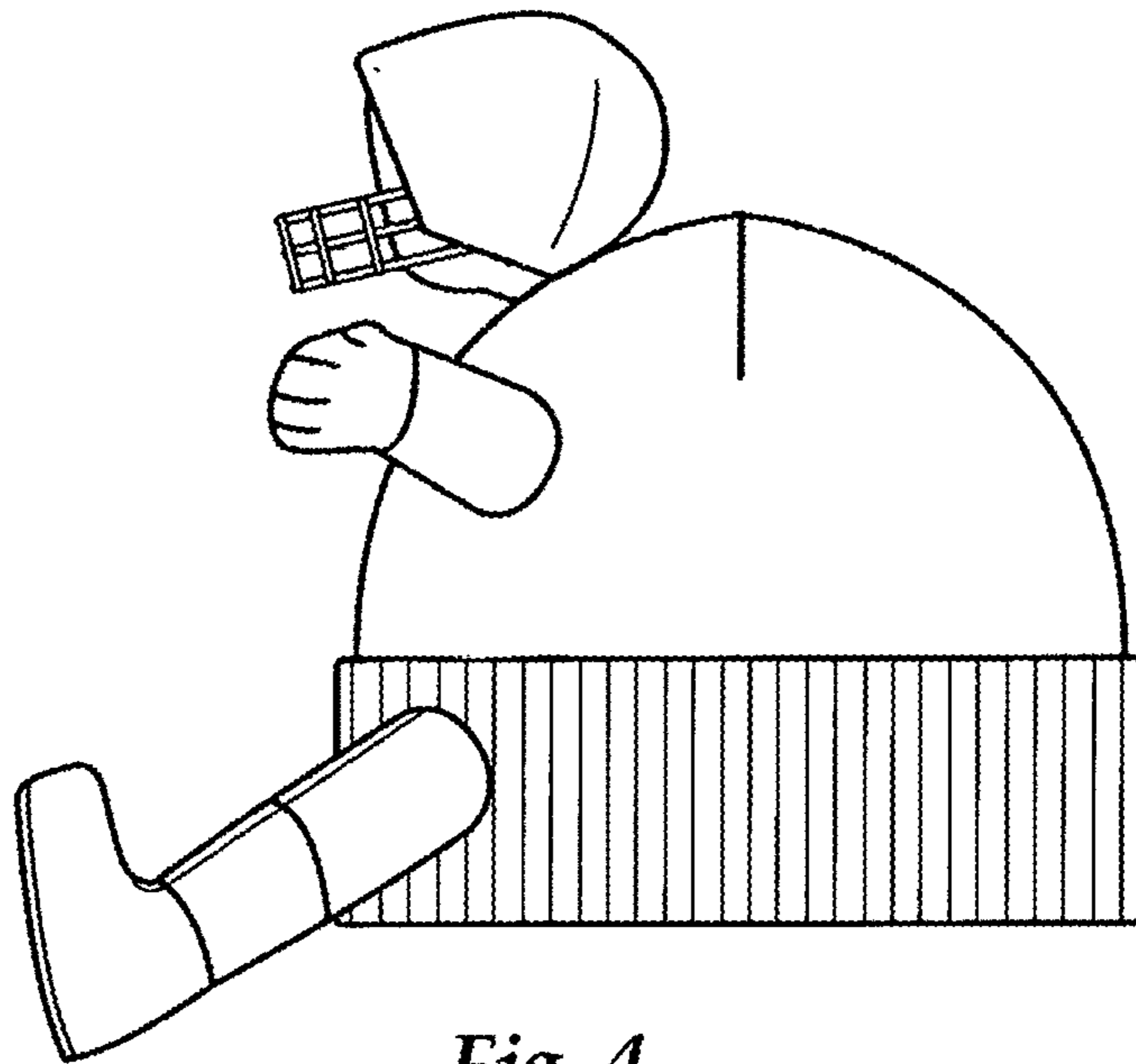

Fig. 4

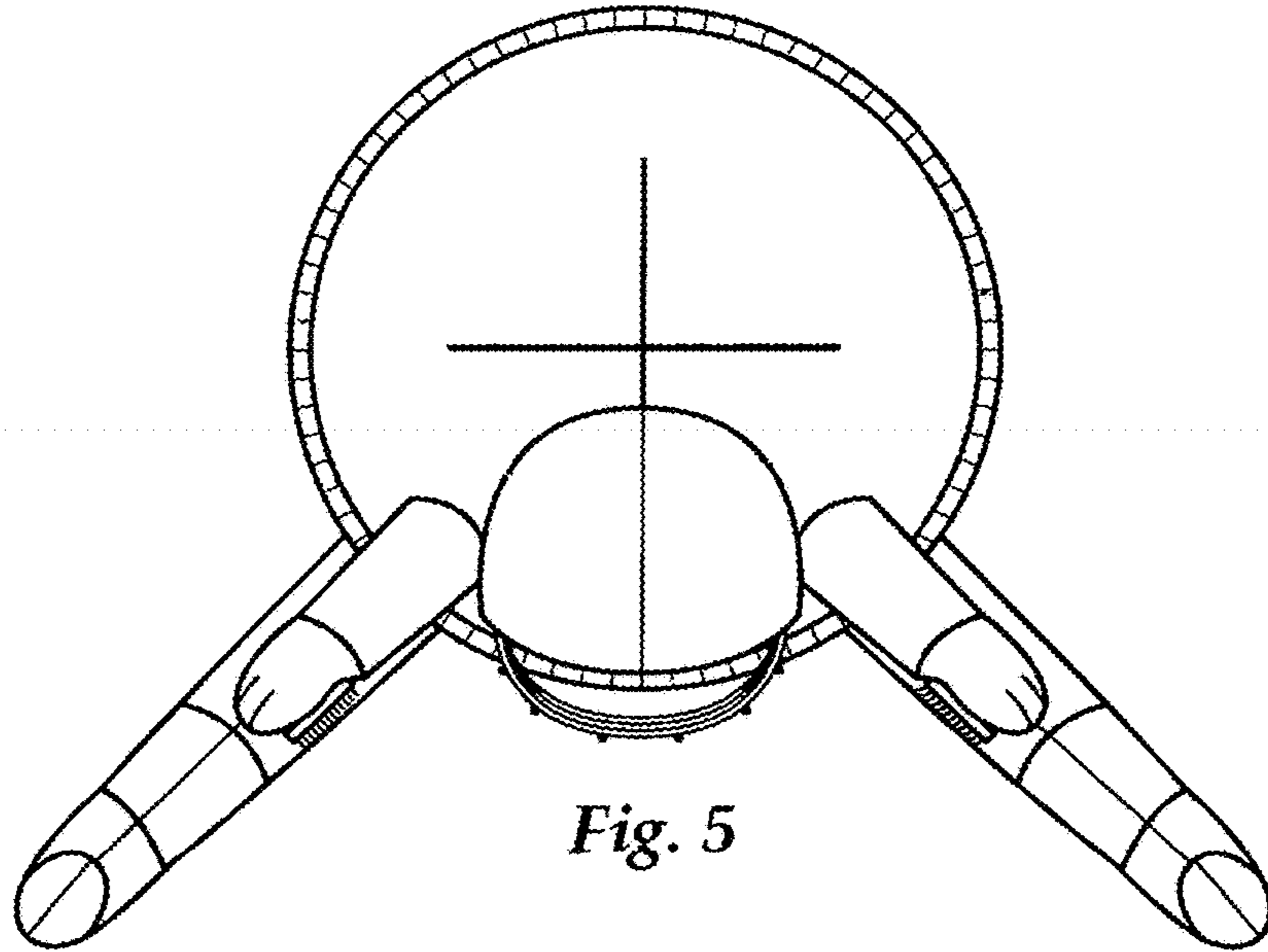

Fig. 5

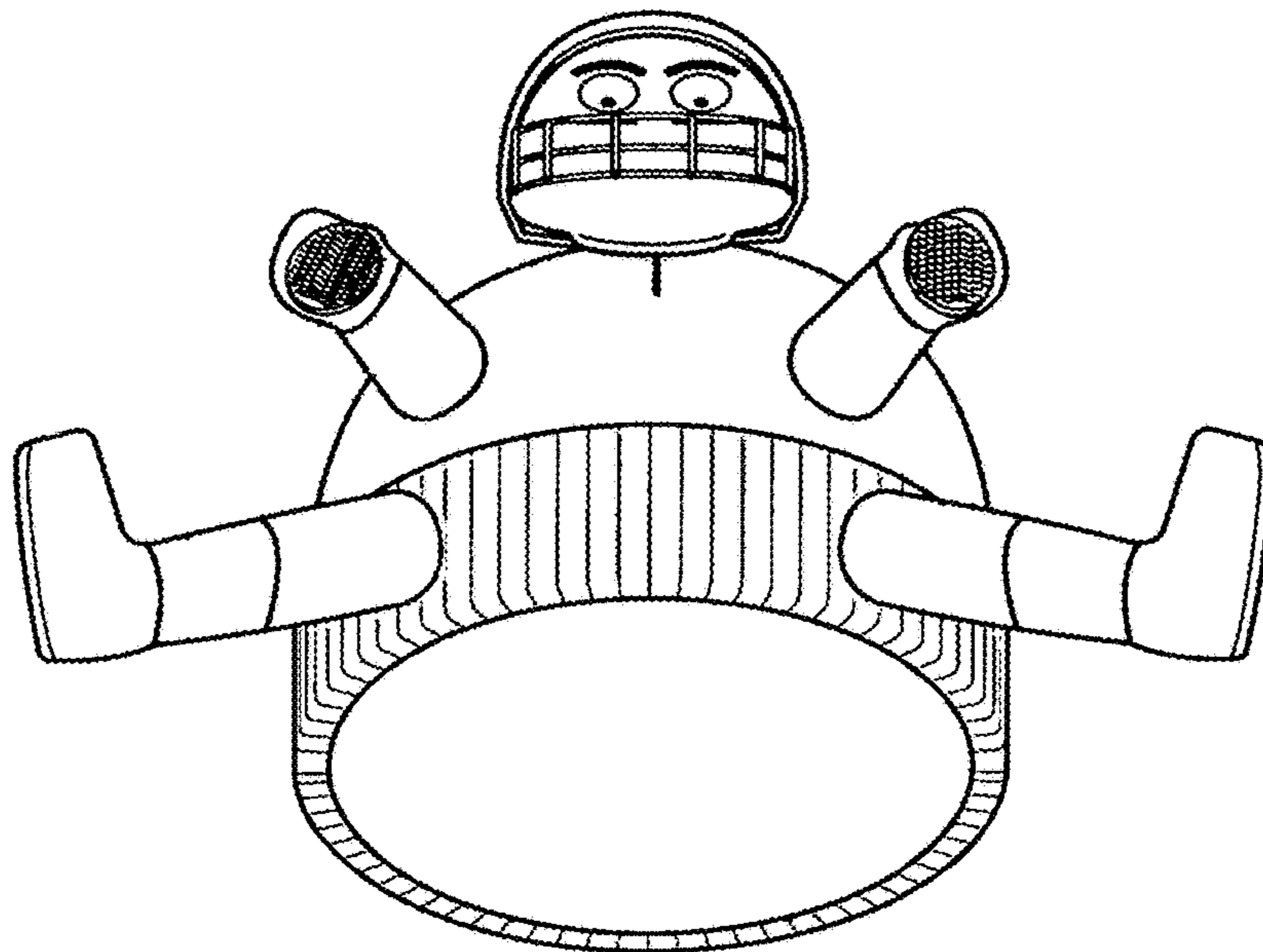

Fig. 6