



US00D779079S

(12) **United States Design Patent** (10) **Patent No.:** **US D779,079 S**
Perović (45) **Date of Patent:** **** Feb. 14, 2017**

(54) **FOLDABLE SAUNA**

(71) Applicant: **PARMIS d.o.o.**, Ljubljana-Črnuče (SI)

(72) Inventor: **Milan Perović**, Ljubljana (SI)

(73) Assignee: **PARMIS d.o.o.**, Ljubljana Crnuce (SI)

(**) Term: **14 Years**

(21) Appl. No.: **29/507,085**

(22) Filed: **Oct. 23, 2014**

(30) **Foreign Application Priority Data**

Aug. 19, 2014 (EM) 002521898-0001
Aug. 19, 2014 (EM) 002521898-0002

(51) **LOC (10) Cl.** **23-02**

(52) **U.S. Cl.**
USPC **D24/203**

(58) **Field of Classification Search**
USPC D6/671.1; D21/815; D23/278, 360, 362;
D24/201, 203, 204; D32/17; 4/424, 526,
4/532, 590; 392/375, 416
(Continued)

(56) **References Cited**

U.S. PATENT DOCUMENTS

148,487 A 3/1874 Miller et al.
348,923 A 9/1886 Munro
(Continued)

FOREIGN PATENT DOCUMENTS

EM 000111802-0002 * 3/2004
JP S5920166 A 2/1984
WO 2007/069873 A1 6/2007

OTHER PUBLICATIONS

Folding Personal Sauna, posted at Mobilevenue.com, posting date
Nov. 13, 2007, © Mobilevenue.com, [online], [site visited Nov. 19,

2015]. Available from Internet, <URL: <http://www.mobilevenue.com/folding-personal-sauna-11133715/>>.*

(Continued)

Primary Examiner — Susan E Krakower
Assistant Examiner — Lisa A Grabenstetter
(74) *Attorney, Agent, or Firm* — Bryant J. Keller; Kirton
McConkie, PC

(57) **CLAIM**

The ornamental design for a foldable sauna, as shown and described.

DESCRIPTION

FIG. 1 is a front, left side perspective view of embodiment one, of a foldable sauna, shown in a collapsed condition, showing my new design;
FIG. 2 is a front side elevation view thereof;
FIG. 3 is a back side elevation view thereof;
FIG. 4 is a right side elevation view thereof;
FIG. 5 is a left side elevation view thereof;
FIG. 6 is a top plan view thereof;
FIG. 7 is a bottom plan view thereof;
FIG. 8 is a front, left side perspective view of embodiment two, of a foldable sauna, shown in an expanded condition, showing my new design;
FIG. 9 is a front elevation view thereof;
FIG. 10 is a back elevation view thereof;
FIG. 11 is a right side elevation view thereof;
FIG. 12 is a left side elevation view thereof;
FIG. 13 is a top plan view thereof;
FIG. 14 is a bottom plan view thereof;
FIG. 15 is a front, left side perspective view of embodiment three, of a foldable sauna, shown in a collapsed condition, showing my new design;
FIG. 16 is a front side elevation view thereof;
FIG. 17 is a back side elevation view thereof;
FIG. 18 is a right side elevation view thereof;
FIG. 19 is a left side elevation view thereof;
FIG. 20 is a top plan view thereof;
FIG. 21 is a bottom plan view thereof;

(Continued)

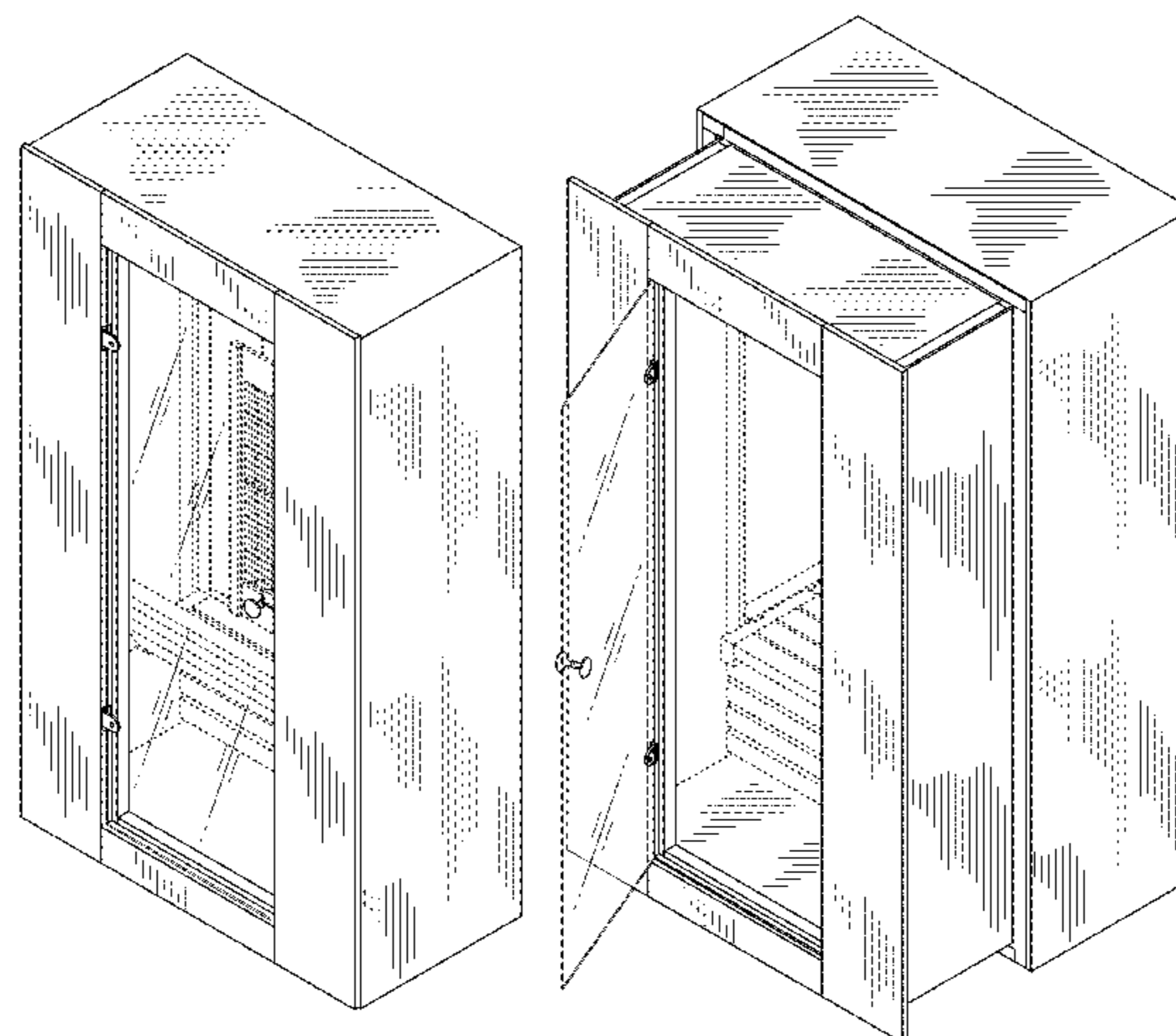

FIG. 22 is a front, left side perspective view of embodiment four, of a foldable sauna, shown in an expanded condition, showing my new design;
 FIG. 23 is a front elevation view thereof;
 FIG. 24 is a back elevation view thereof;
 FIG. 25 is a right side elevation view thereof;
 FIG. 26 is a left side elevation view thereof;
 FIG. 27 is a top plan view thereof; and,
 FIG. 28 is a bottom plan view thereof.
 The broken lines depicting the interior features of the foldable sauna represent unclaimed portions of the design.

1 Claim, 24 Drawing Sheets

(58) **Field of Classification Search**

CPC A61H 2033/061; A61H 33/00; A61H 33/066;
 A61H 33/067; A61H 33/0087; A61H
 33/02; A61H 33/60; A61H 33/6063
 See application file for complete search history.

(56) **References Cited**

U.S. PATENT DOCUMENTS

548,641 A 10/1895 Hallem
 1,917,629 A 7/1933 Anderson

3,648,299 A * 3/1972 Durst 4/524
 3,875,596 A 4/1975 Noda
 4,031,573 A 6/1977 Romanoff
 5,117,481 A * 5/1992 Sung 392/416
 5,894,698 A 4/1999 Dewald, Jr. et al.
 D663,853 S * 7/2012 Zack et al. D24/203
 2002/0046422 A1 * 4/2002 Perett 4/524
 2005/0076430 A1 * 4/2005 Lee 4/524
 2007/0050903 A1 * 3/2007 Sappenfield et al. 4/524
 2007/0169258 A1 7/2007 Hoge
 2007/0294819 A1 * 12/2007 Levesque 4/524
 2008/0005980 A1 * 1/2008 Lin 52/127.1
 2010/0017953 A1 * 1/2010 O’Keeffe et al. 4/524
 2012/0227178 A1 * 9/2012 Lee 4/524
 2014/0345041 A1 11/2014 Barghelame
 2016/0101017 A1 4/2016 Lee

OTHER PUBLICATIONS

“New arrival half body folder and portable sauna infrared sauna cabin”, Retrieved from URL http://www.alibaba.com/product-detail/New-arrival-half-body-folder-and_60070011165.html [Jun. 22, 2015].
www.sinosauna.com; Retrieved from URL <http://www.sinosauna.com/products.aspx> [Jun. 22, 2015].

* cited by examiner

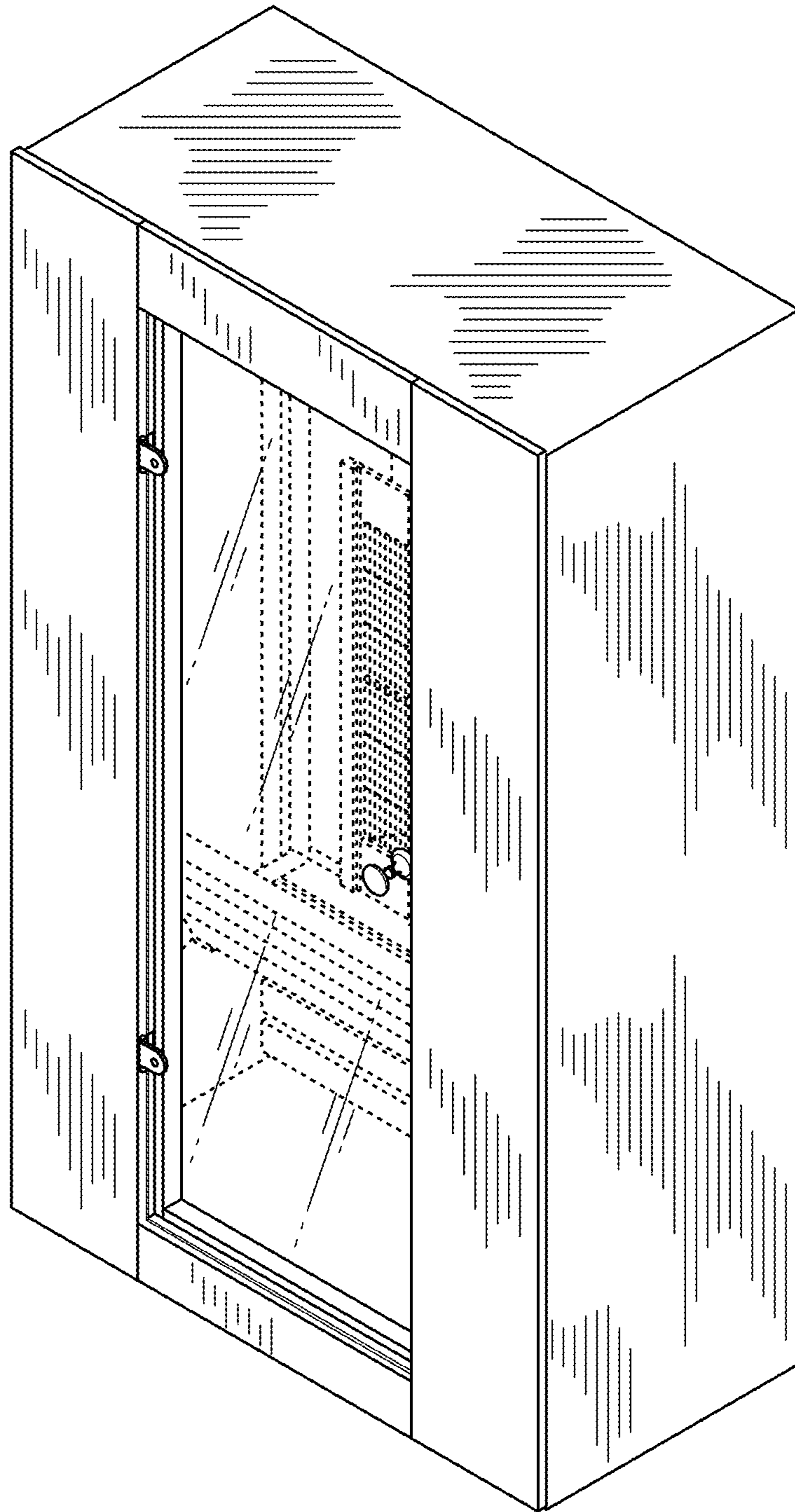

FIG. 1

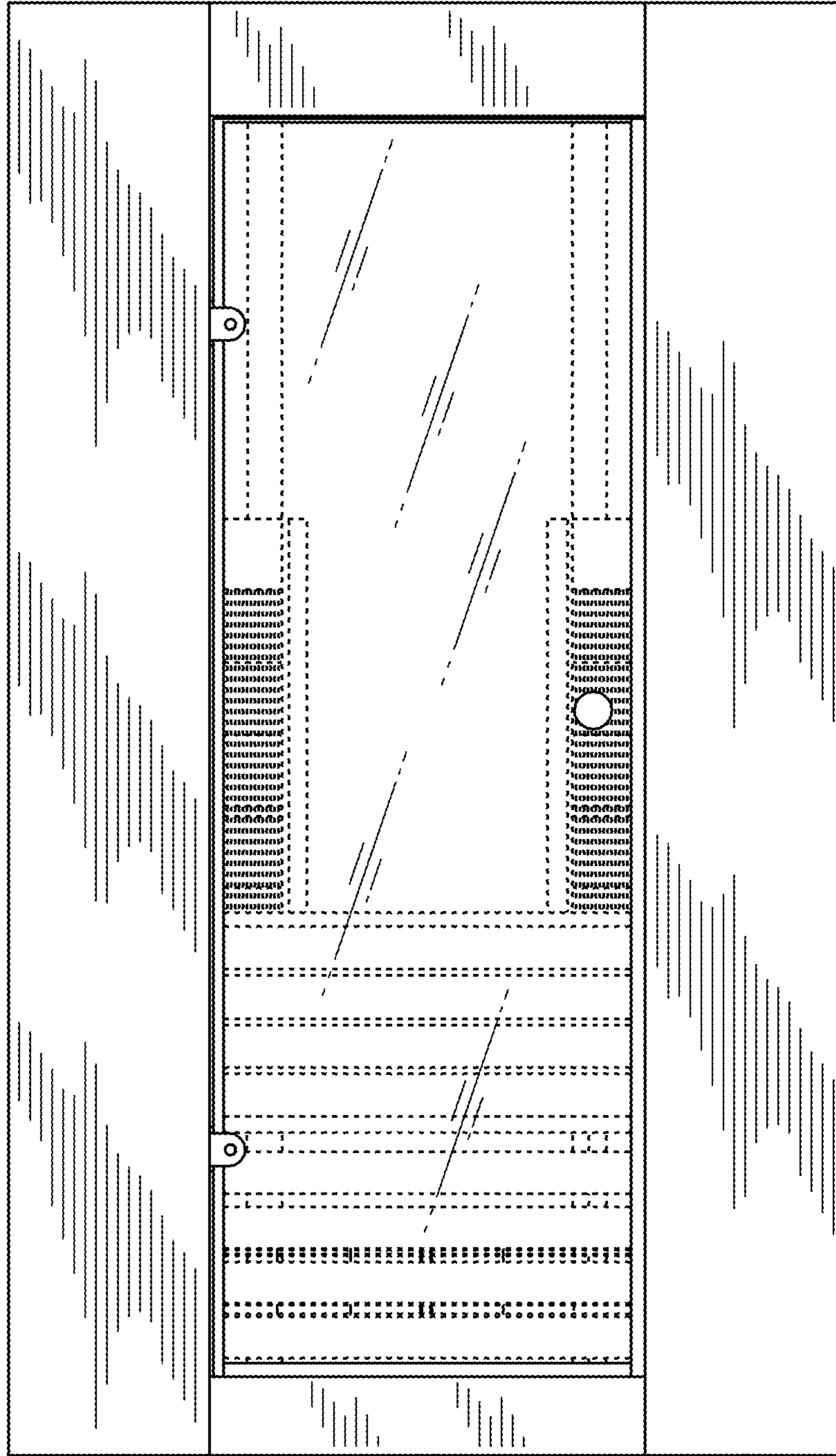

FIG. 2

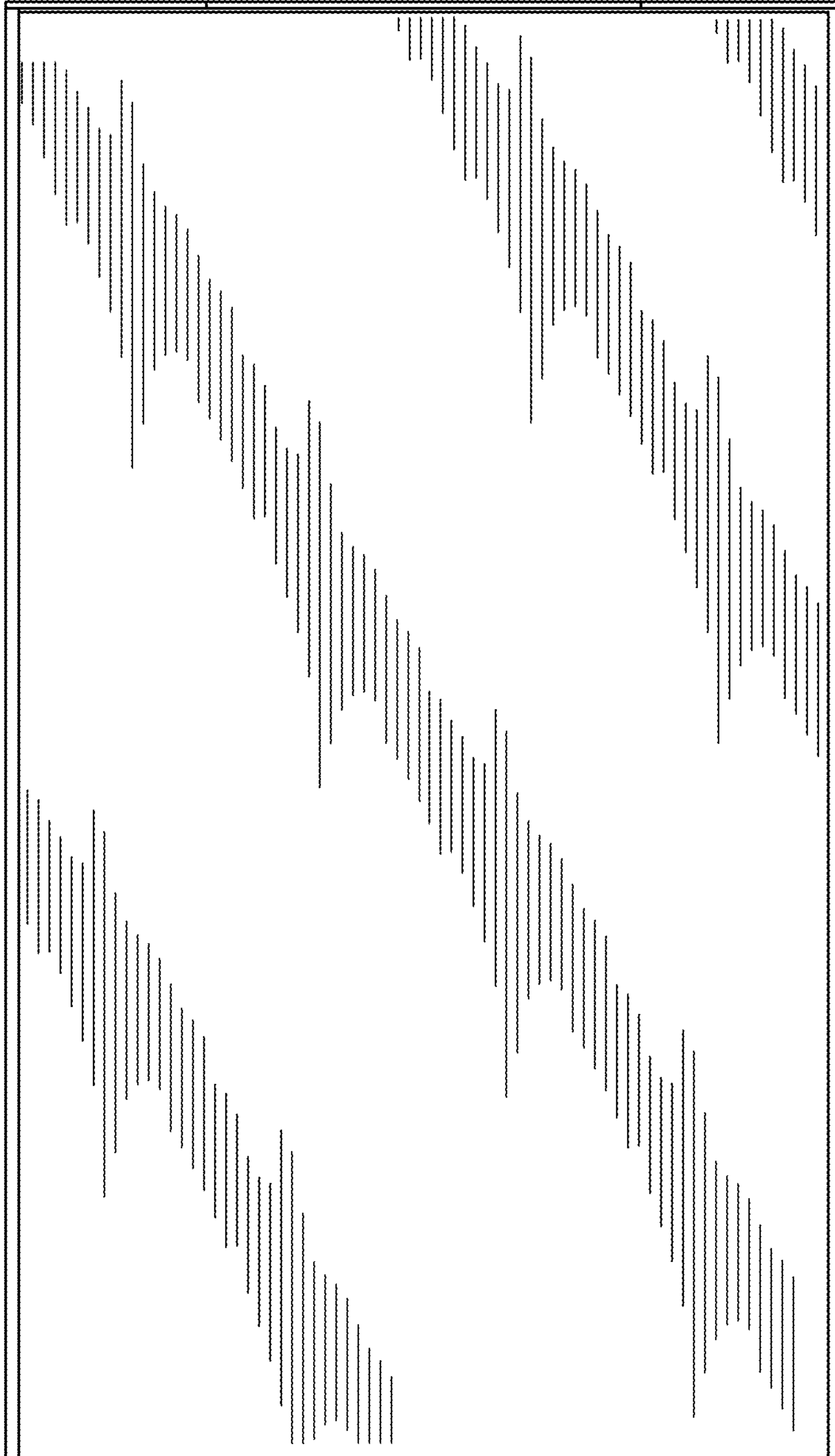

FIG. 3

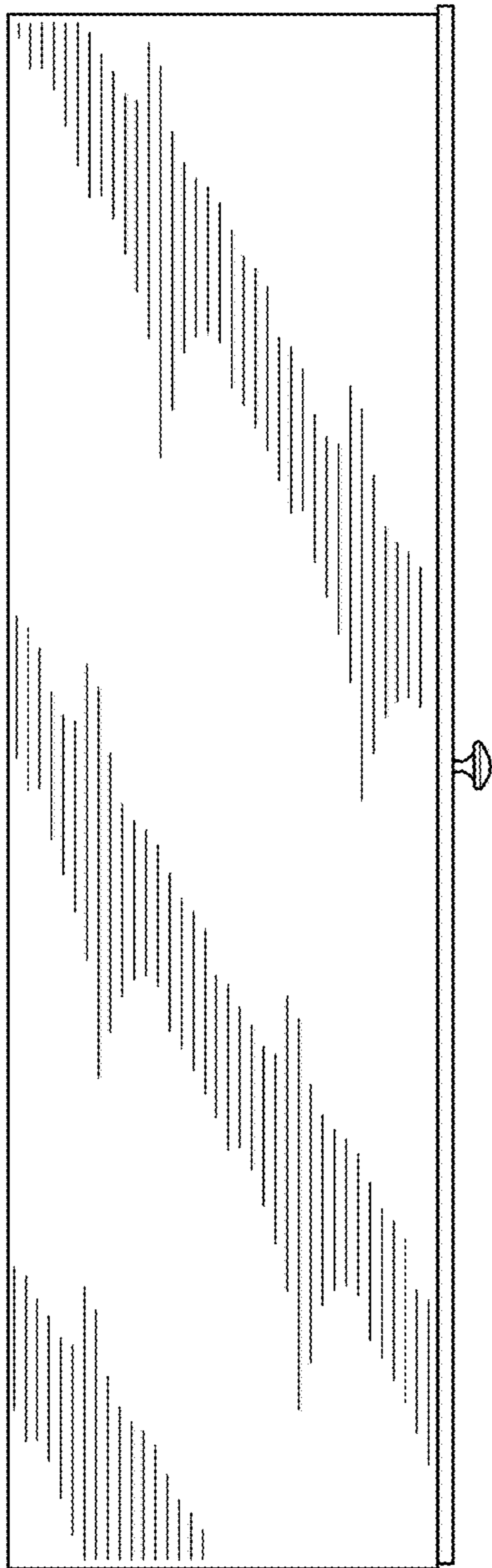

FIG. 4

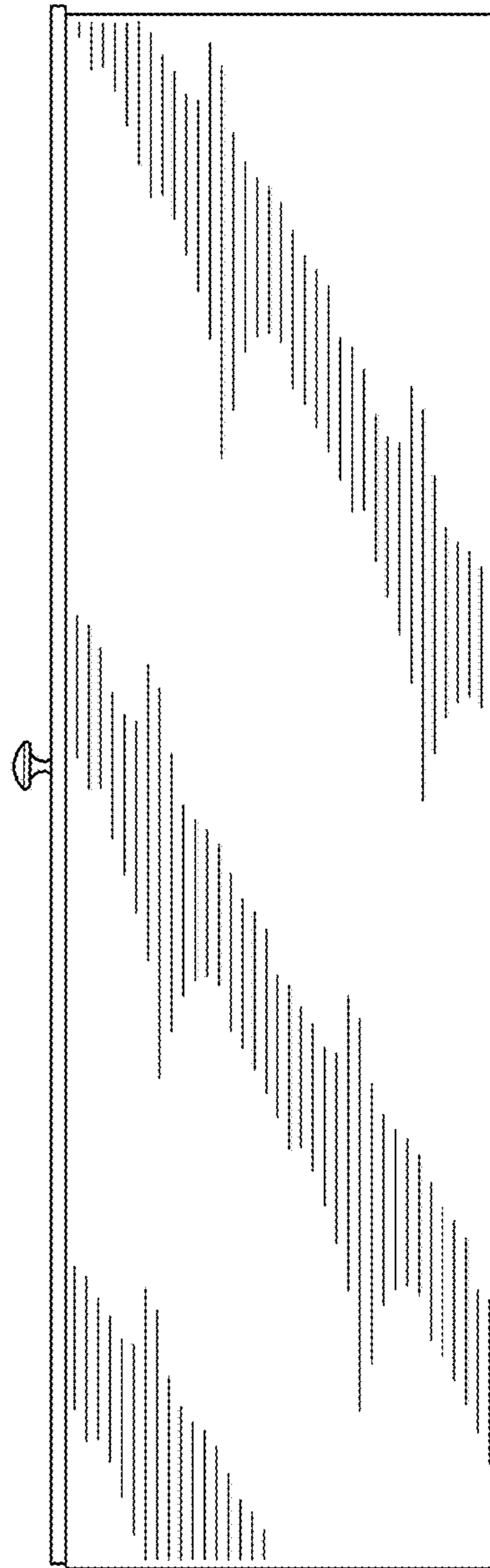

FIG. 5

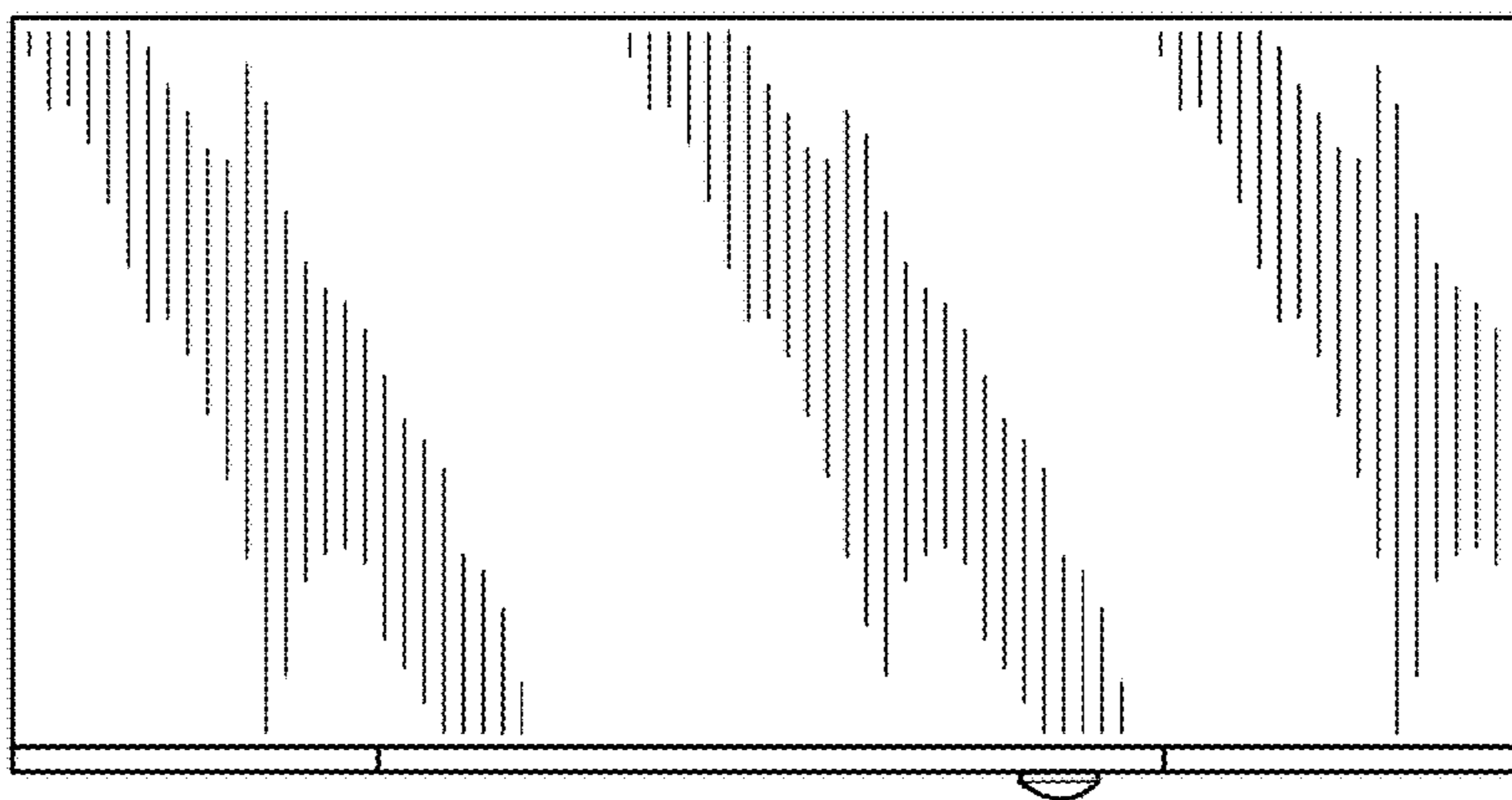

FIG. 6

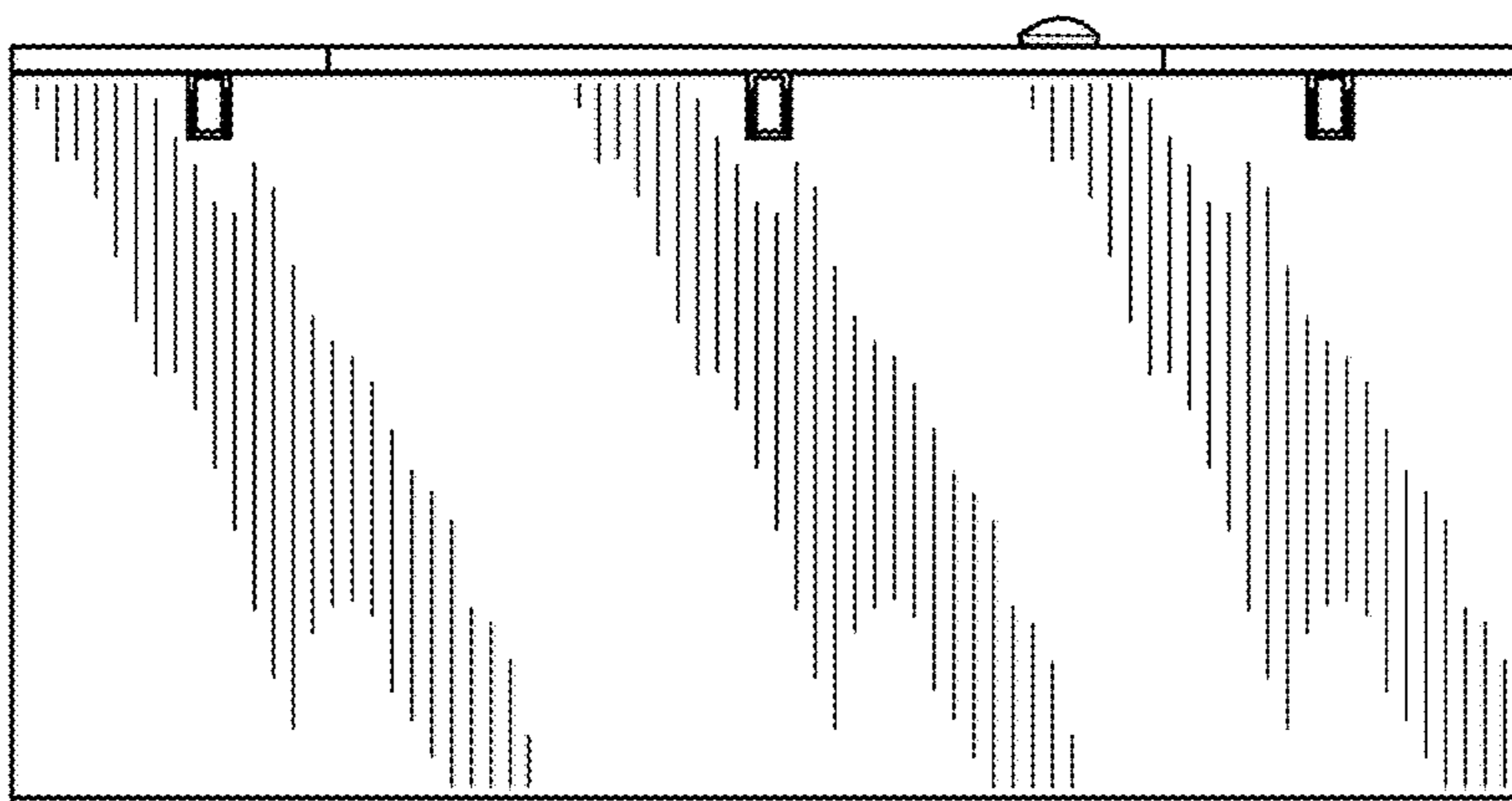

FIG. 7

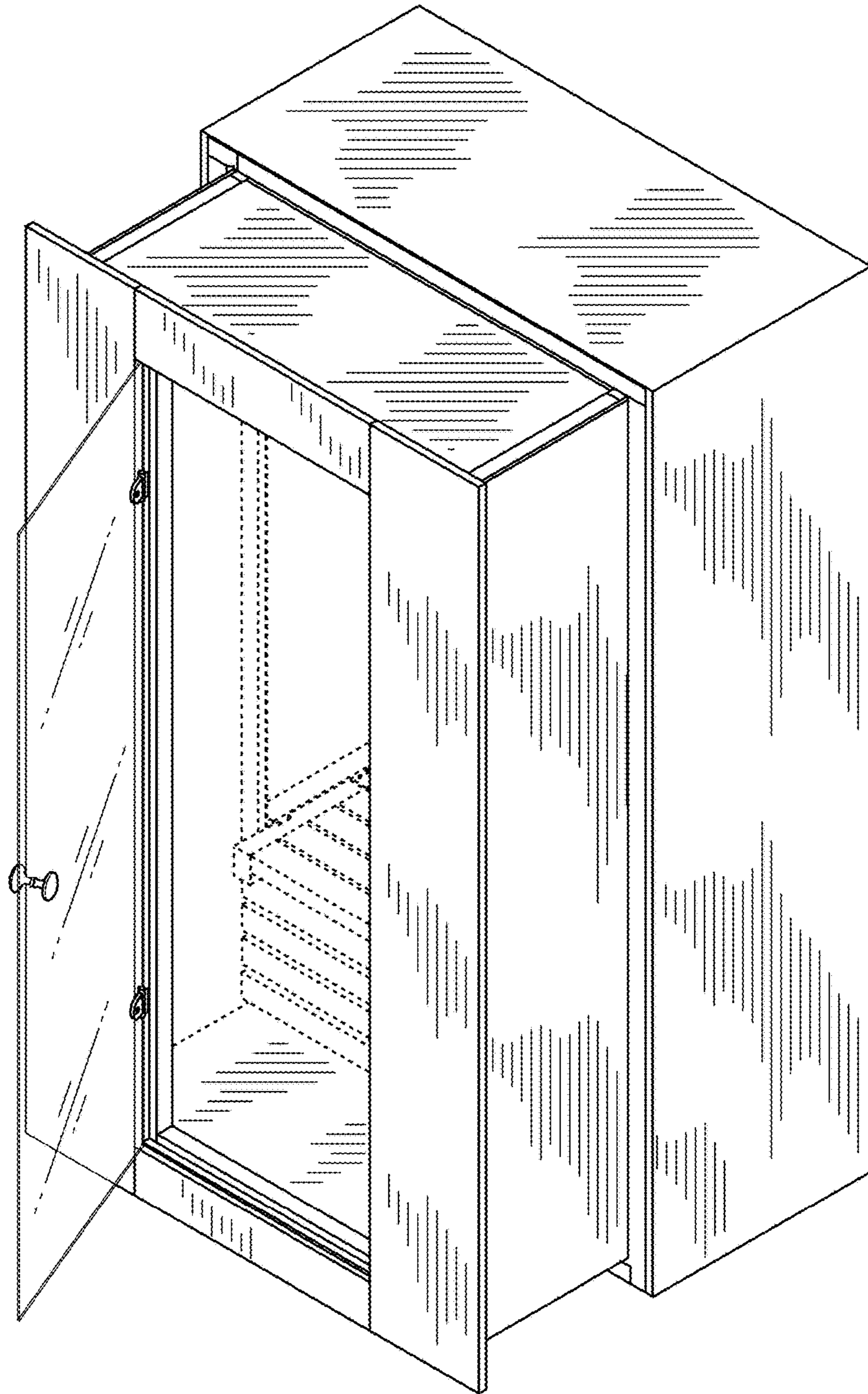

FIG. 8

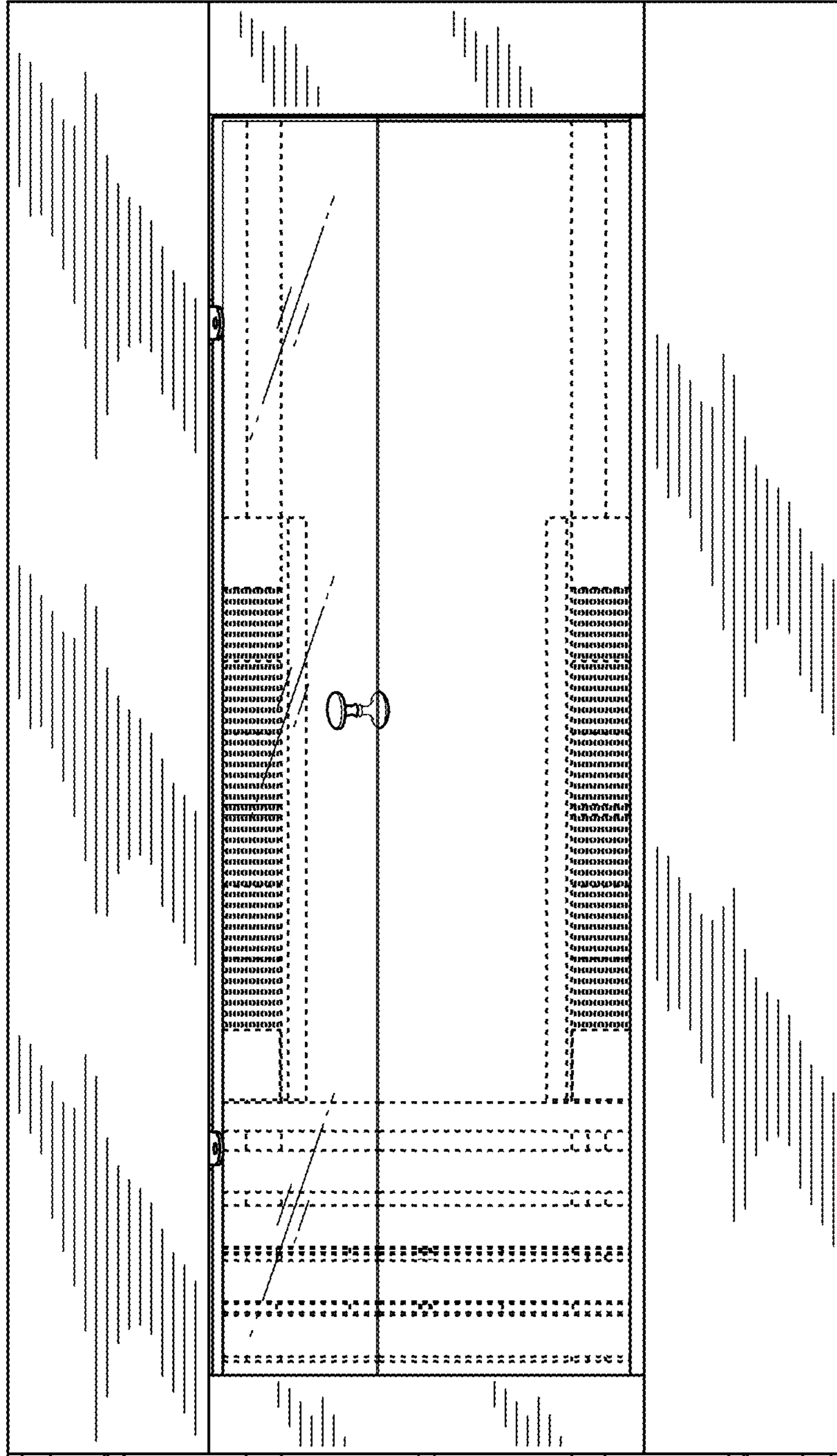

FIG. 9

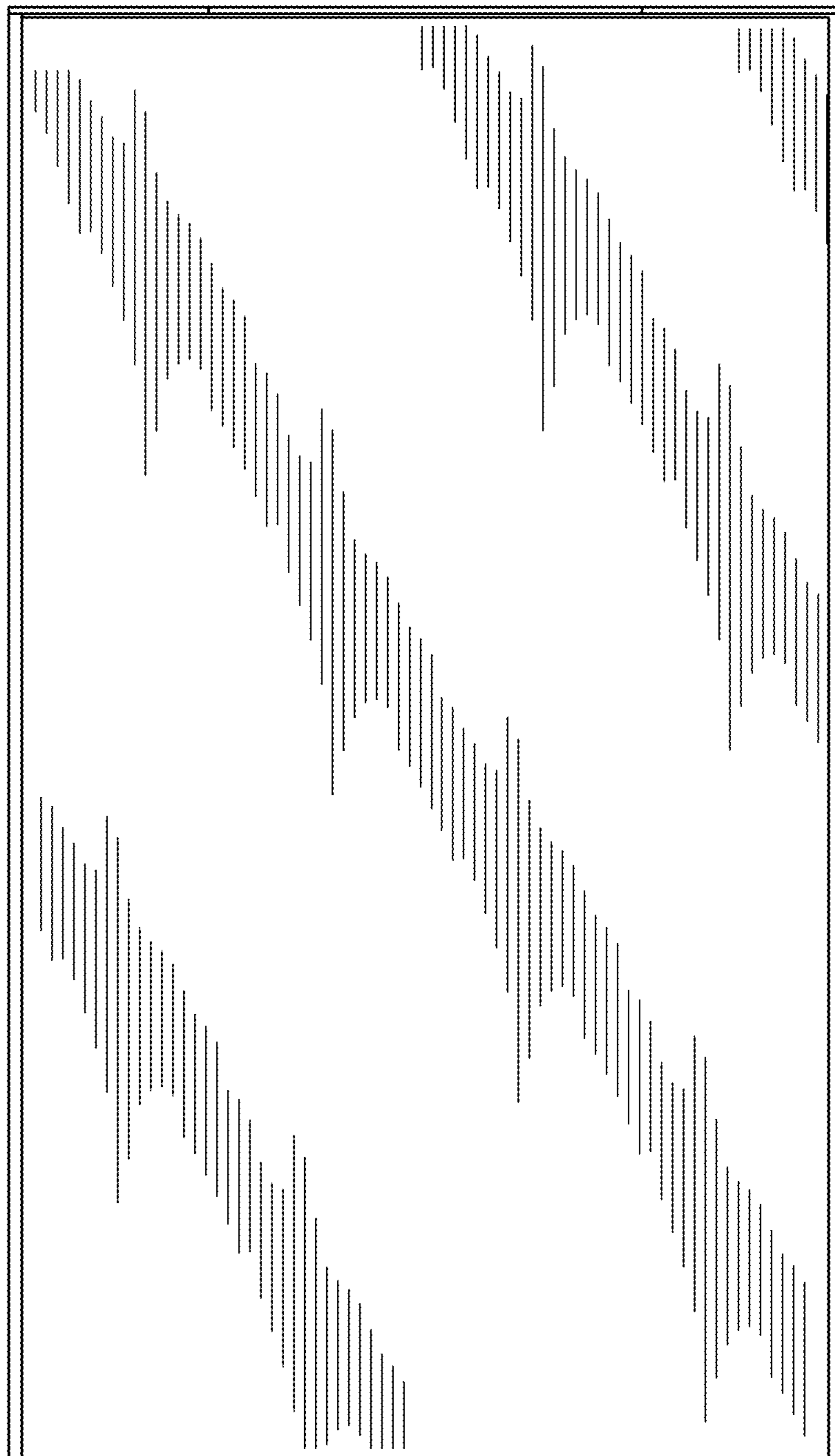

FIG. 10

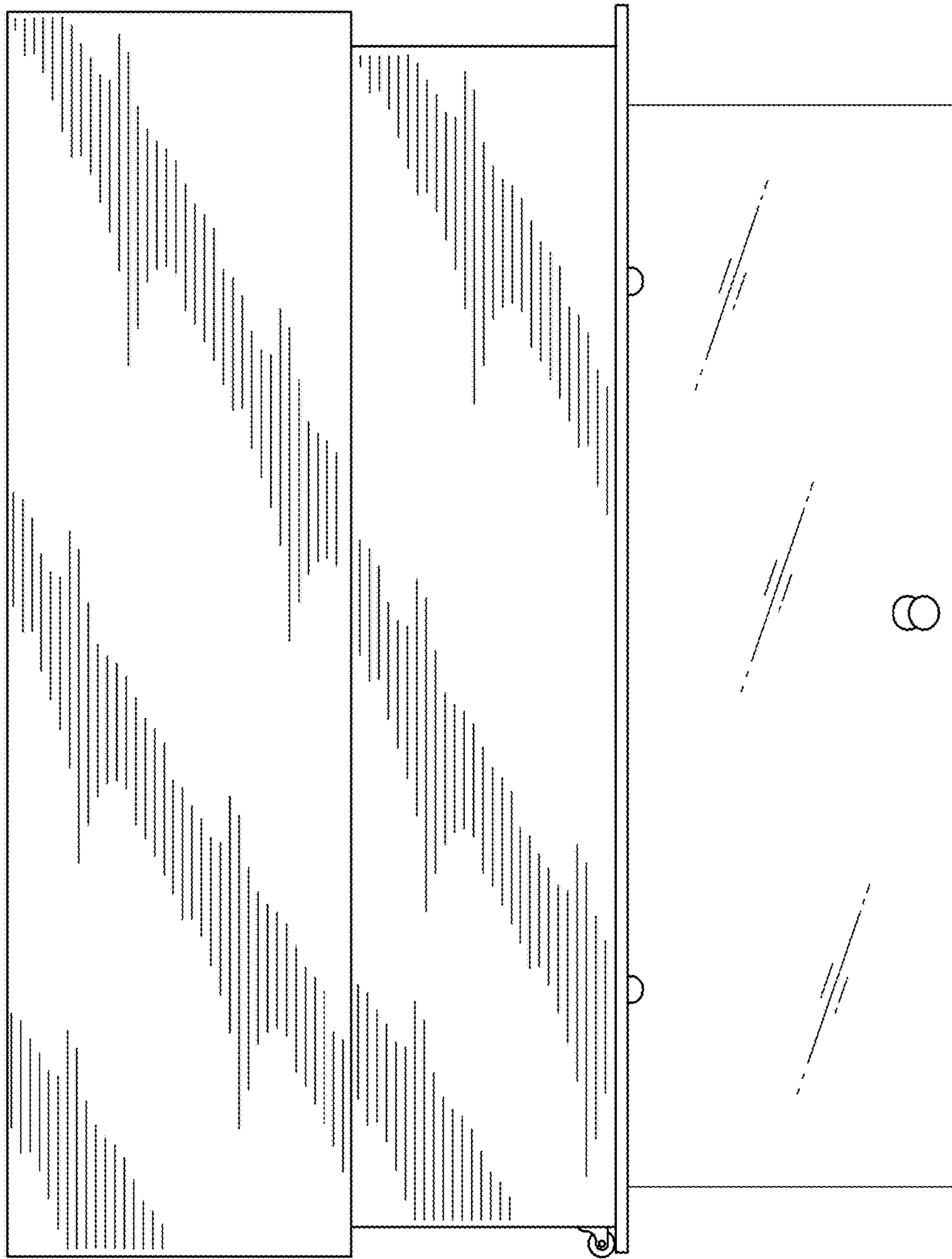

FIG. 11

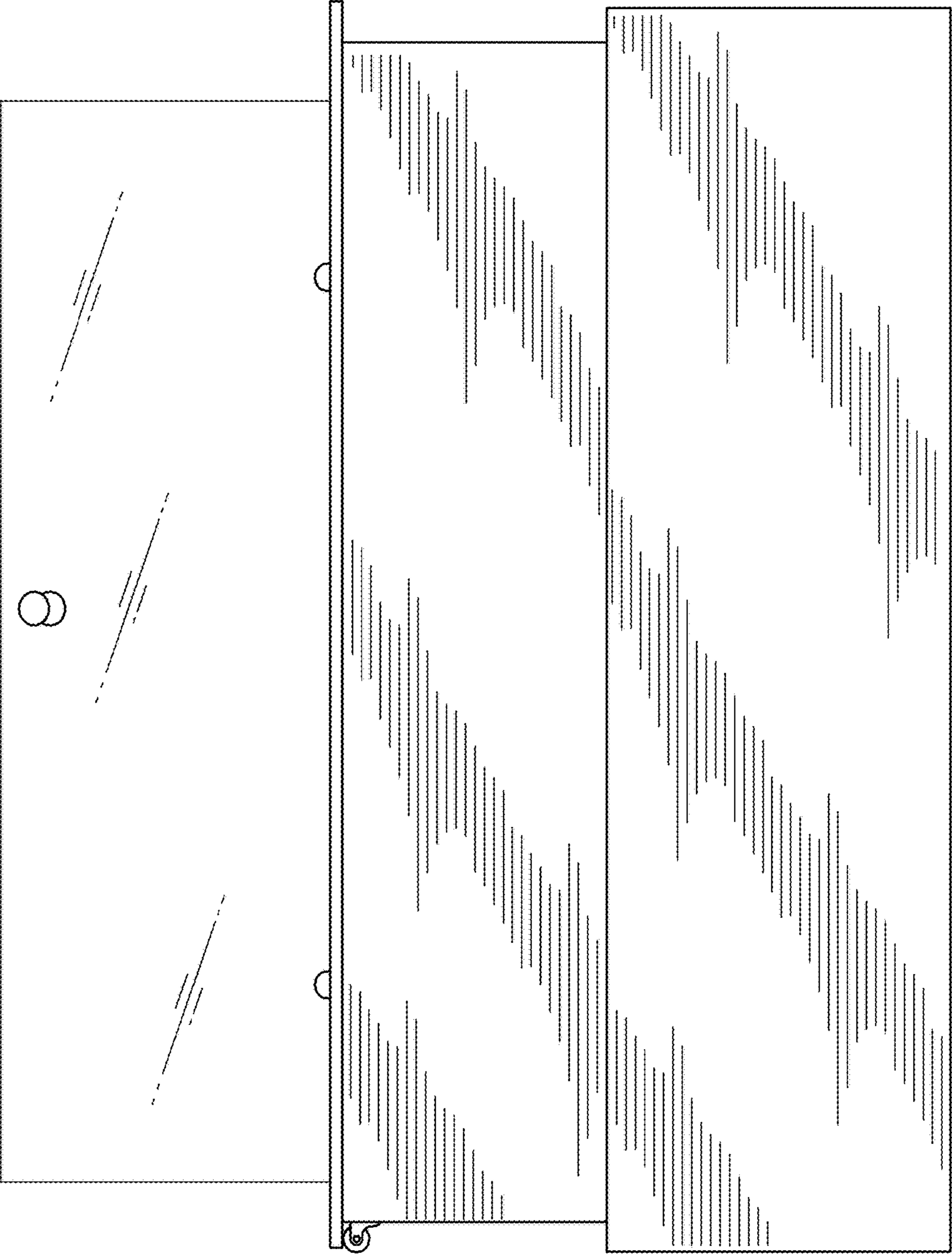

FIG. 12

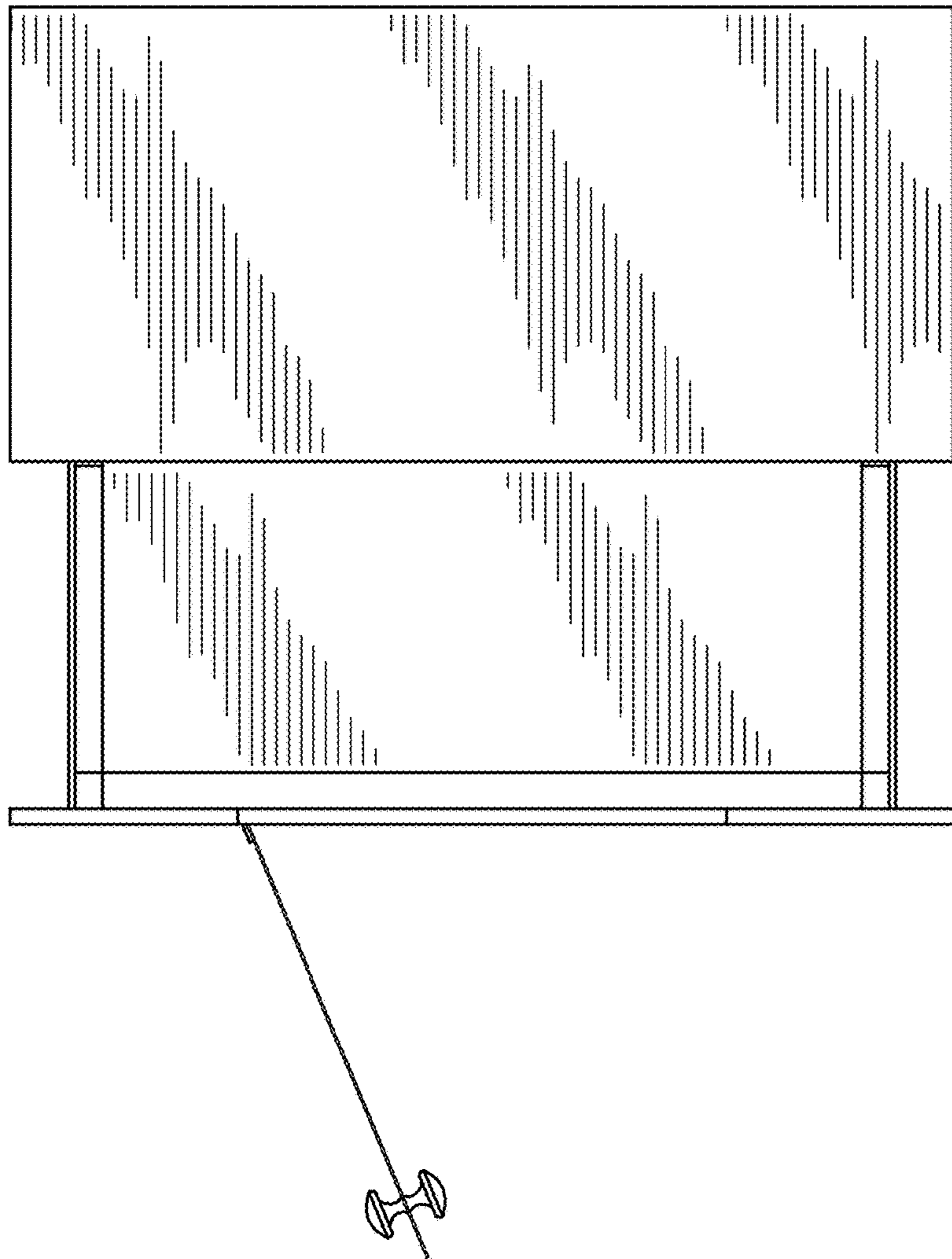

FIG. 13

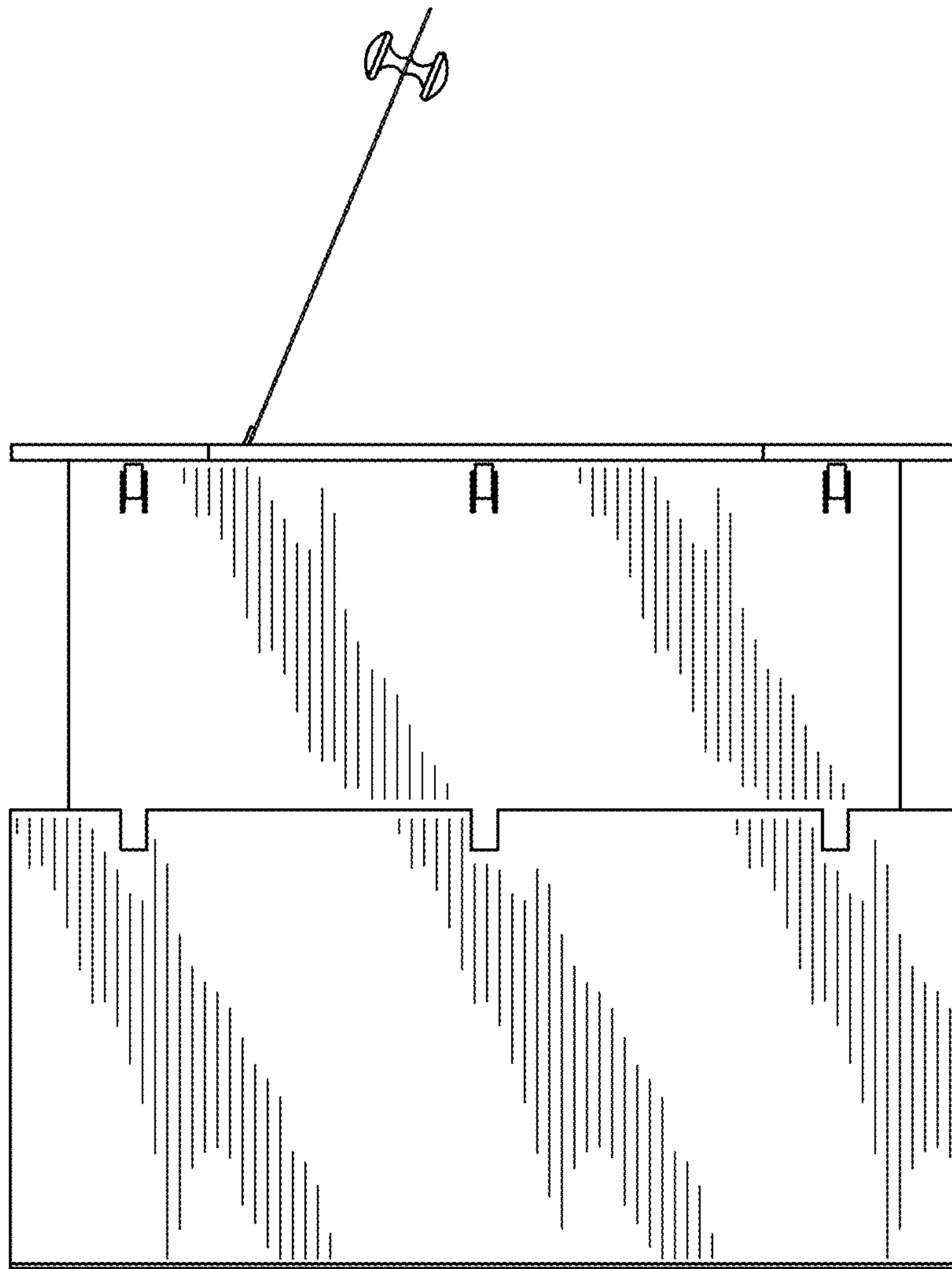

FIG. 14

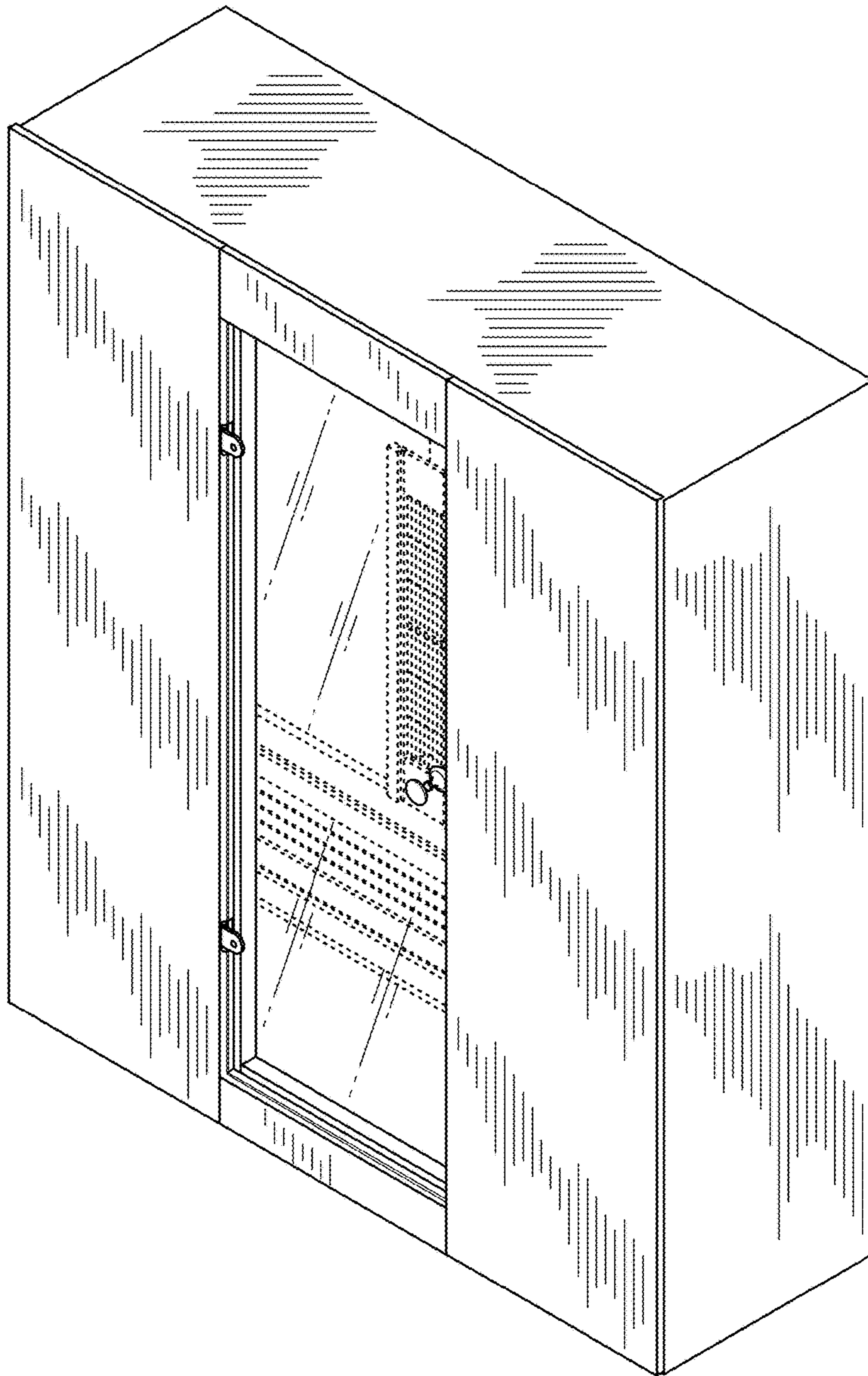

FIG. 15

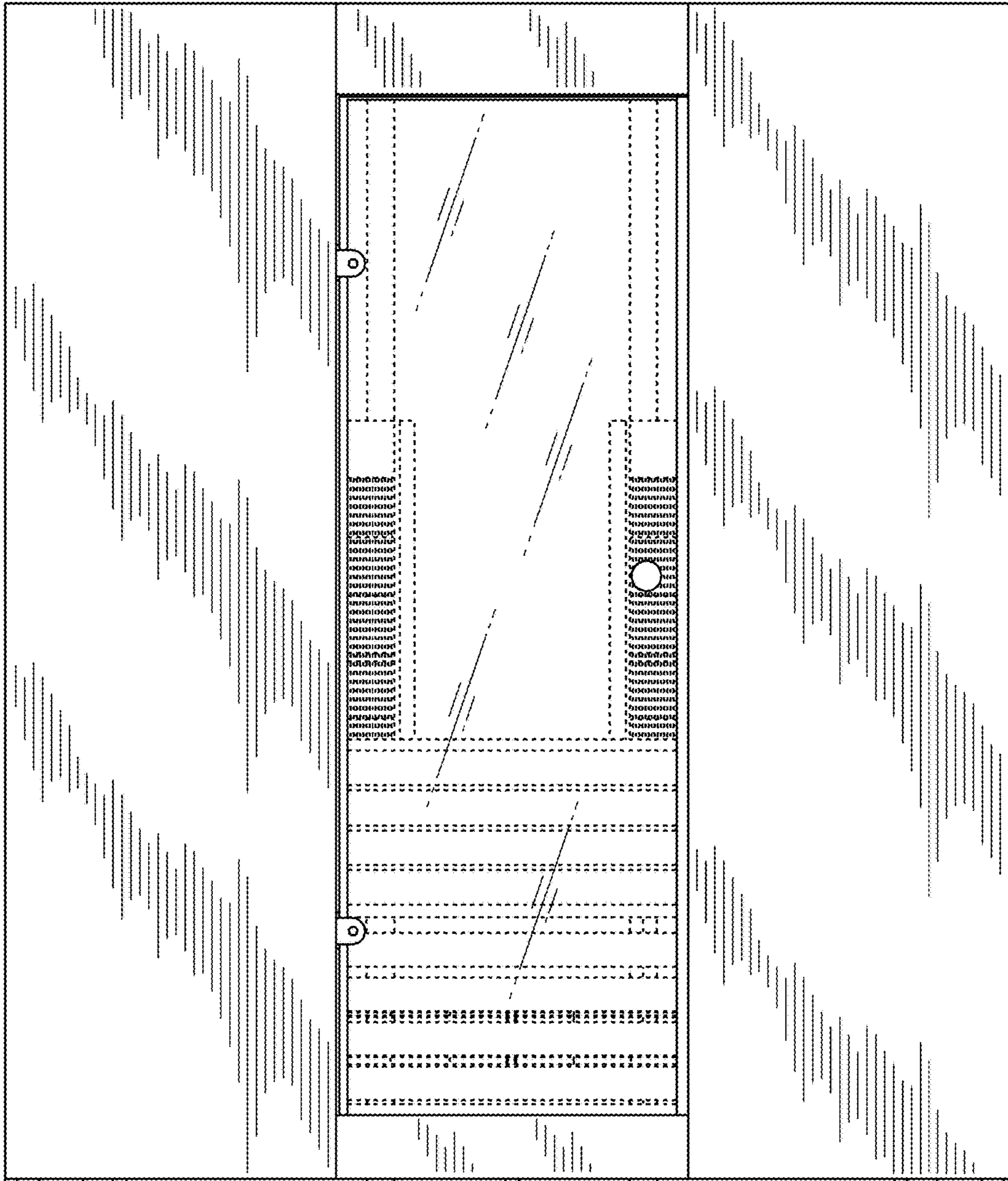

FIG. 16

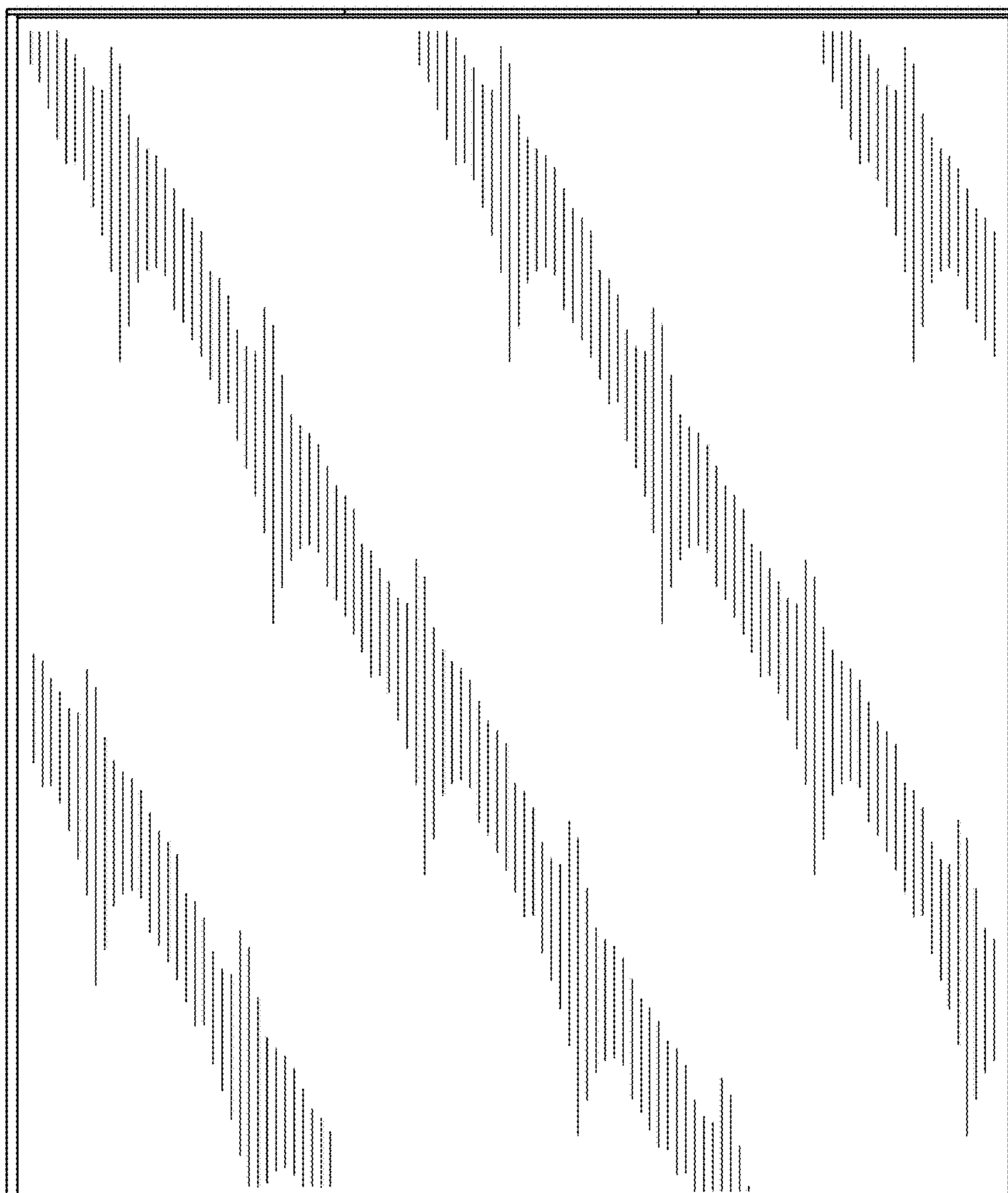

FIG. 17

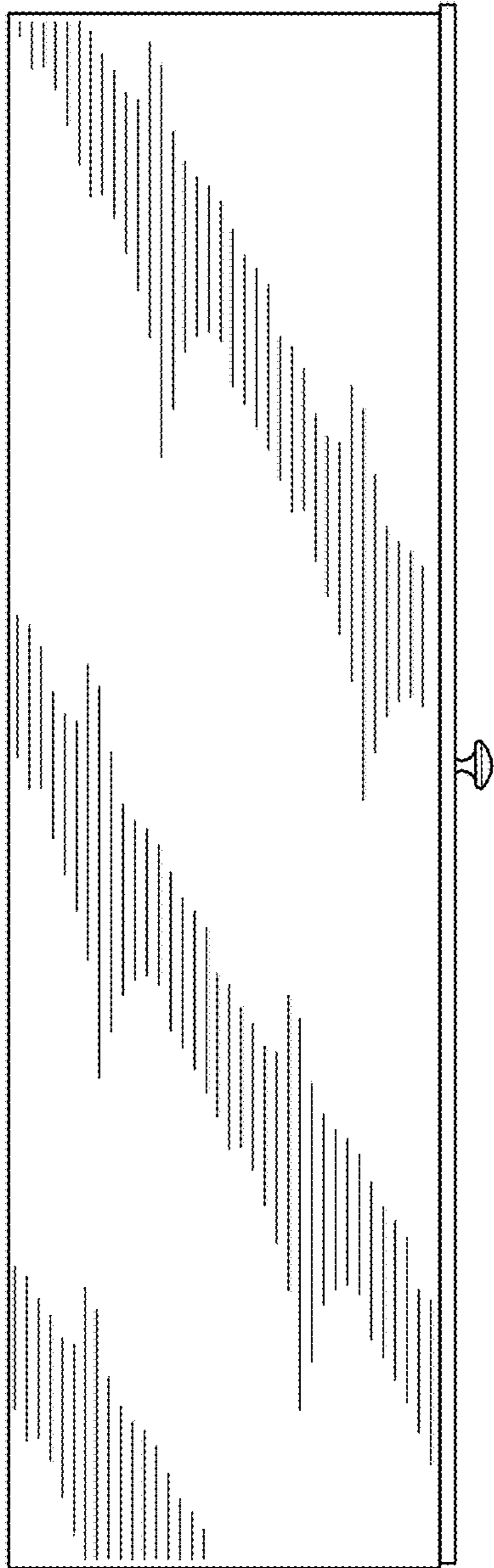

FIG. 18

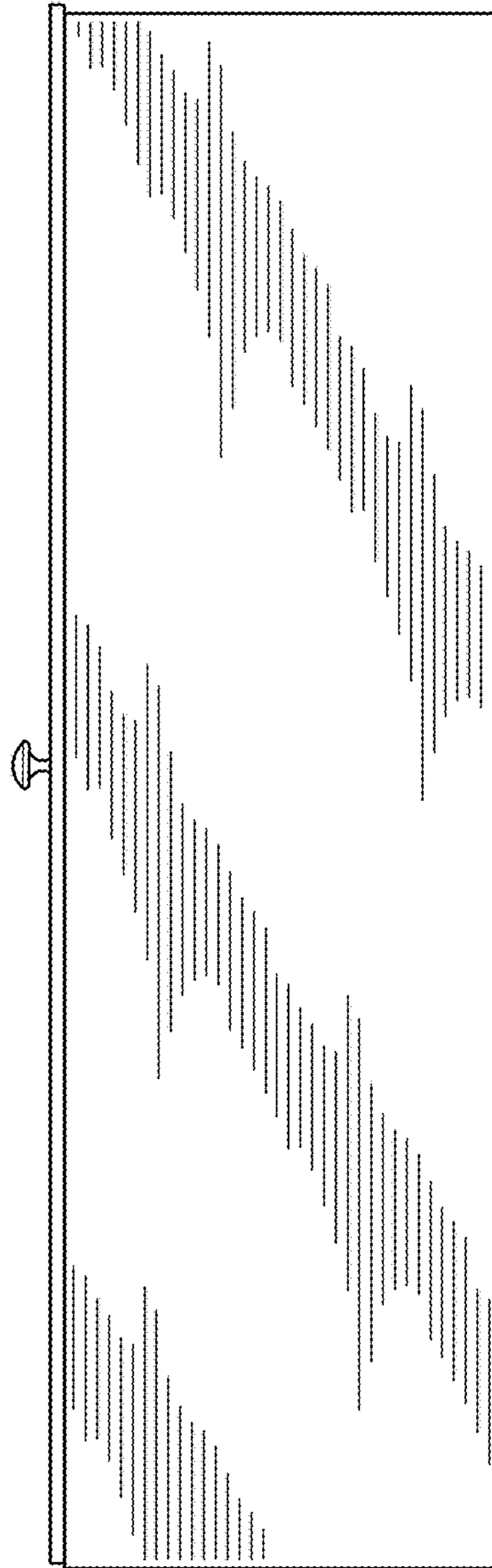

FIG. 19

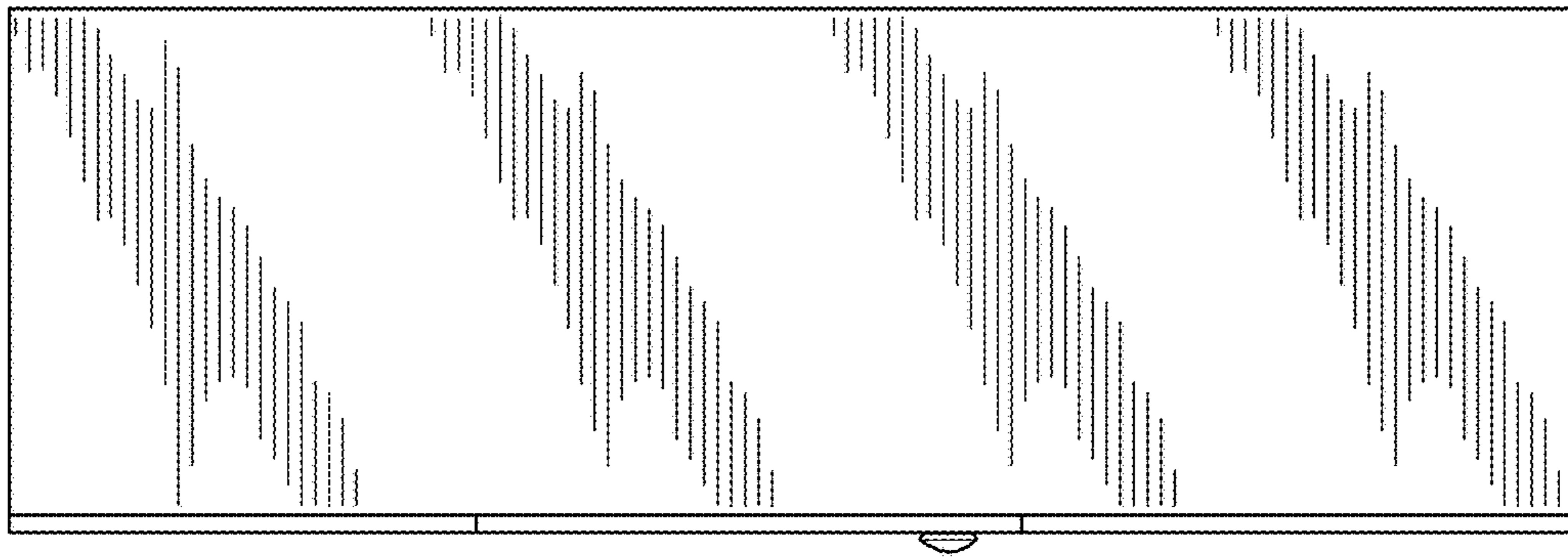

FIG. 20

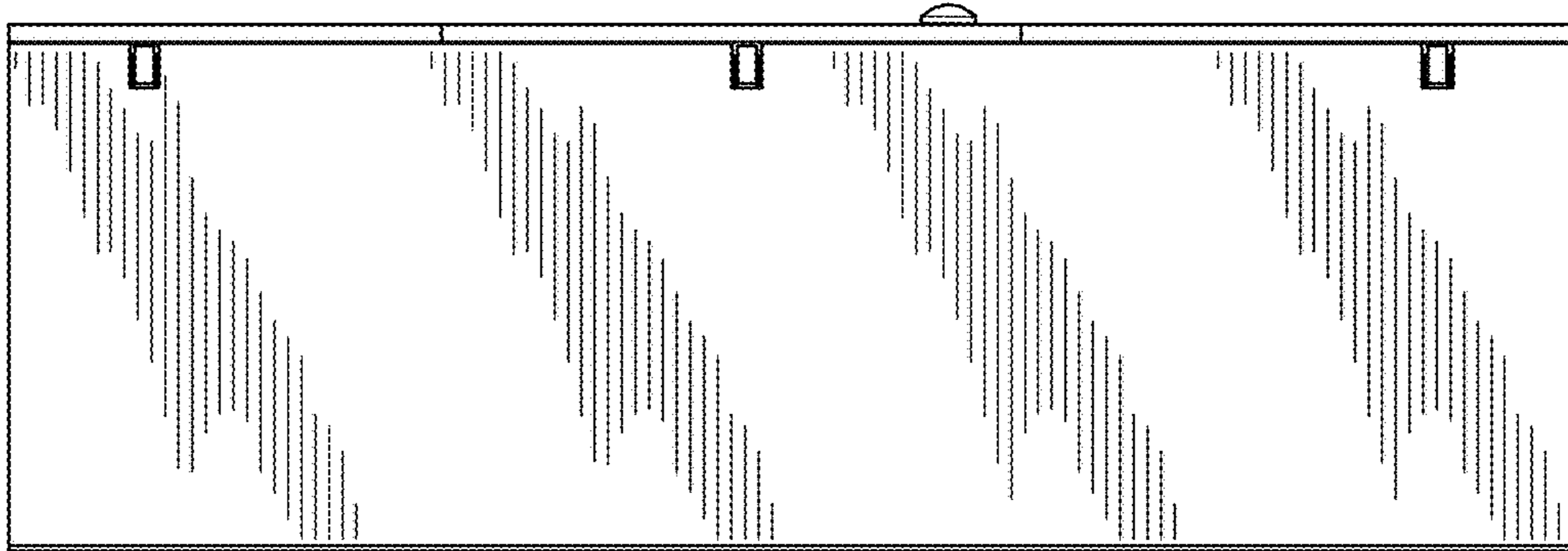

FIG. 21

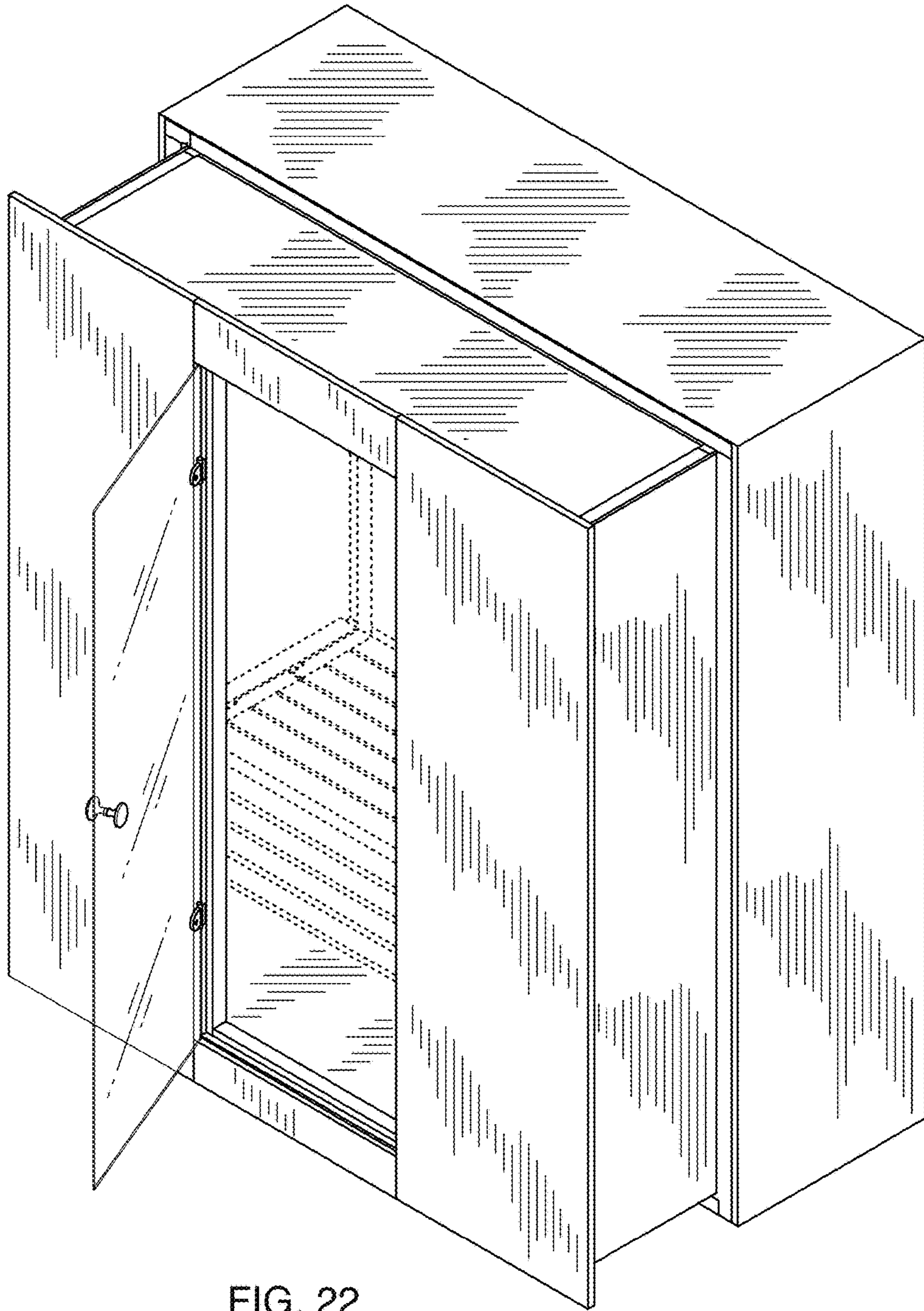

FIG. 22

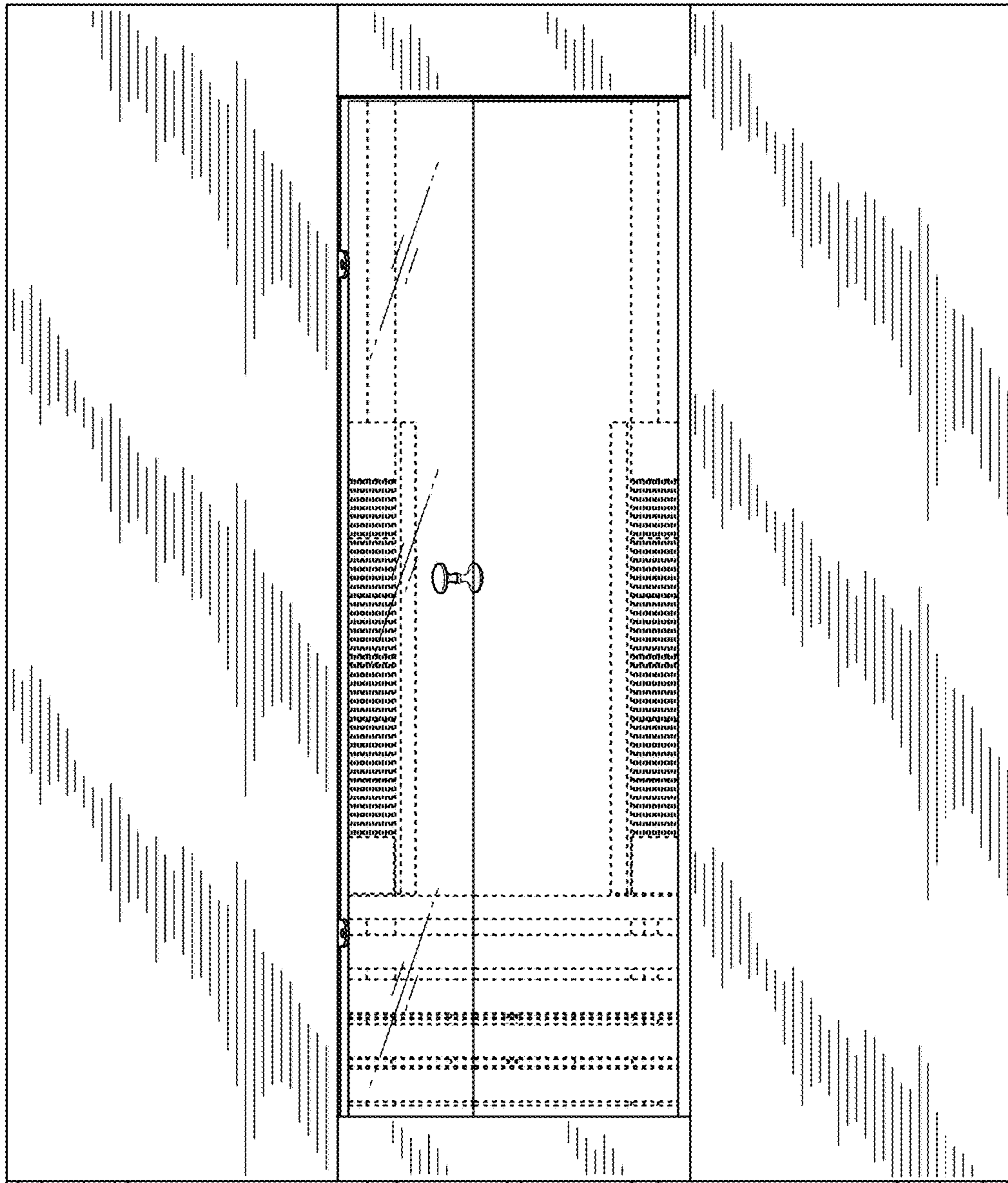

FIG. 23

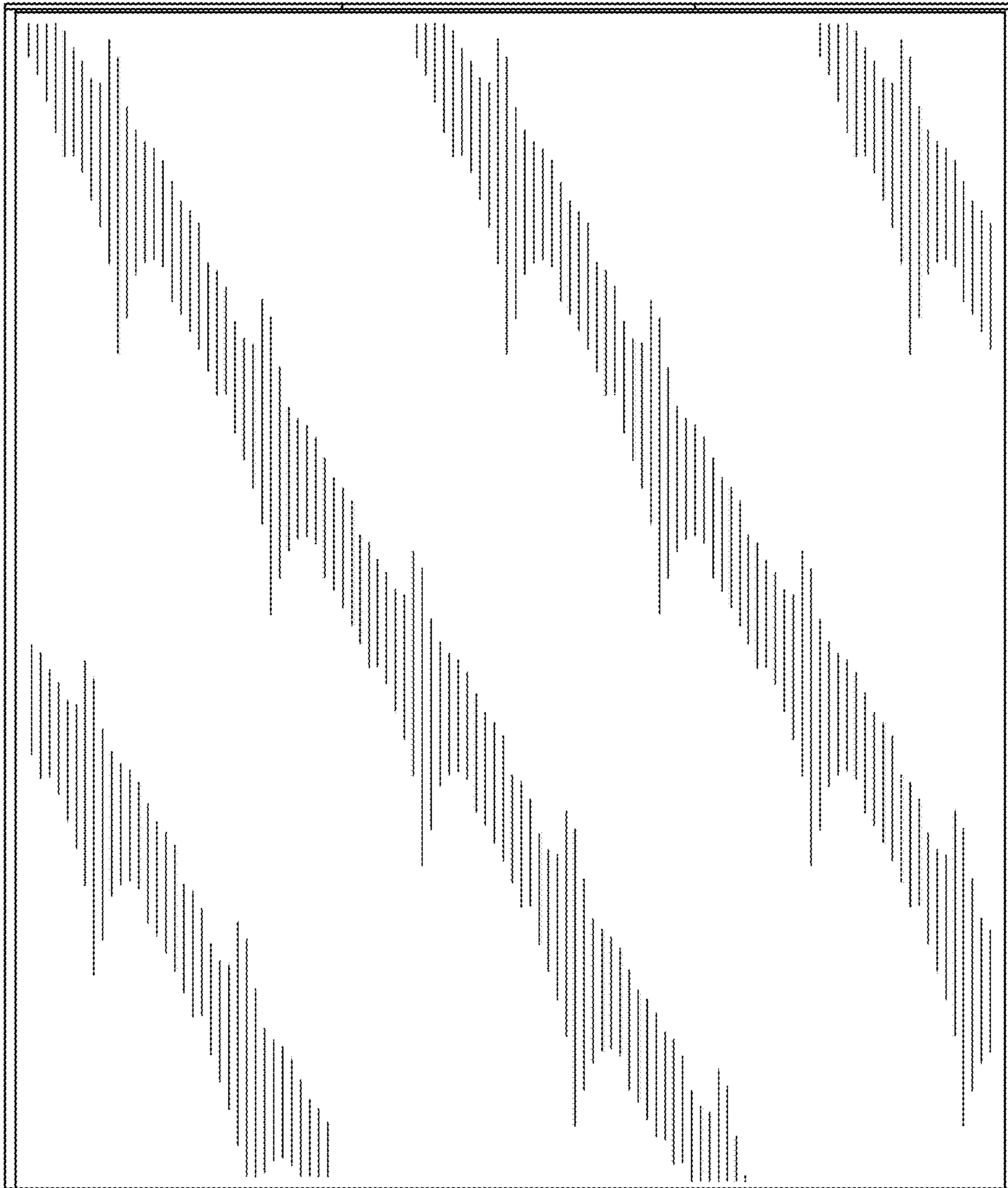

FIG. 24

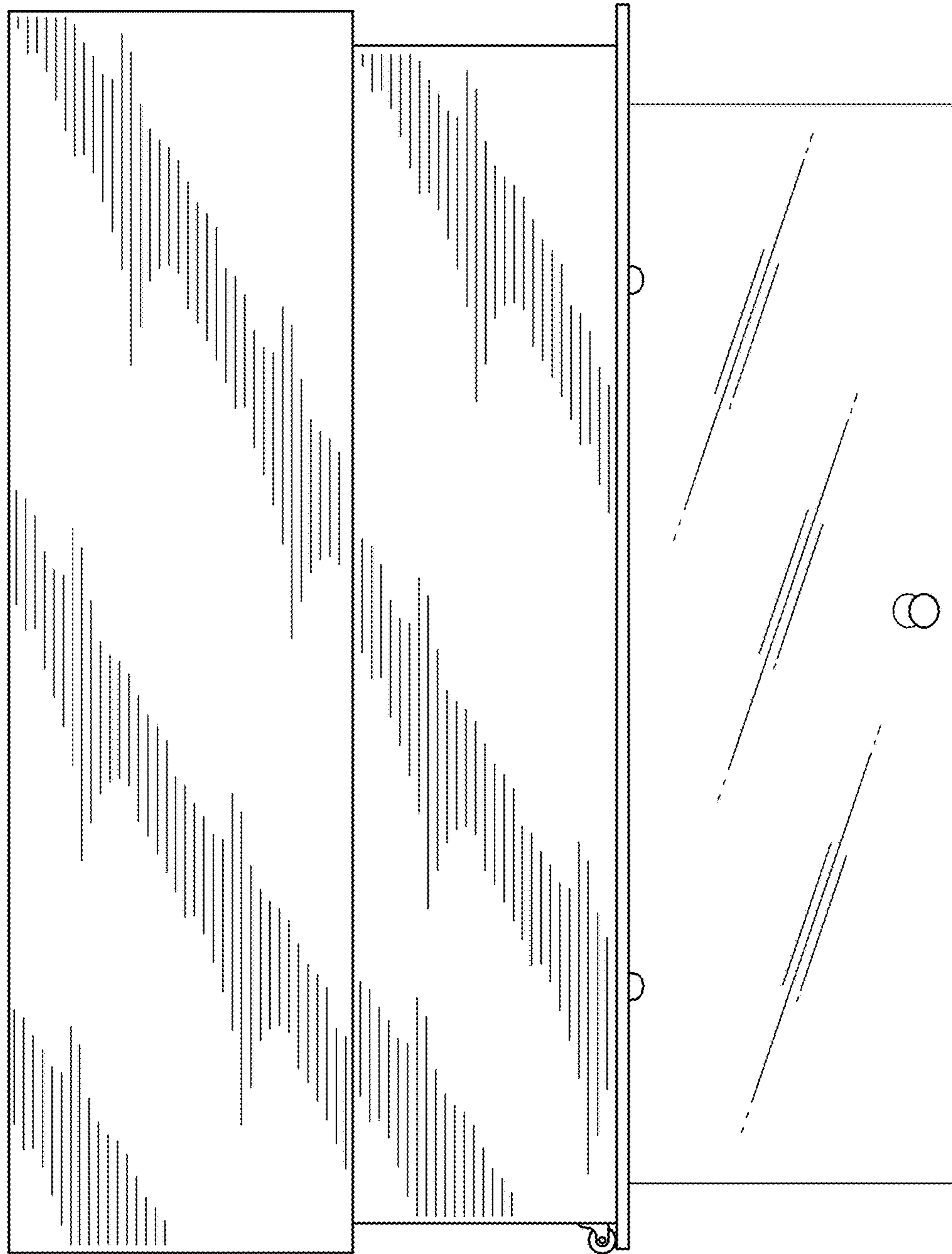

FIG. 25

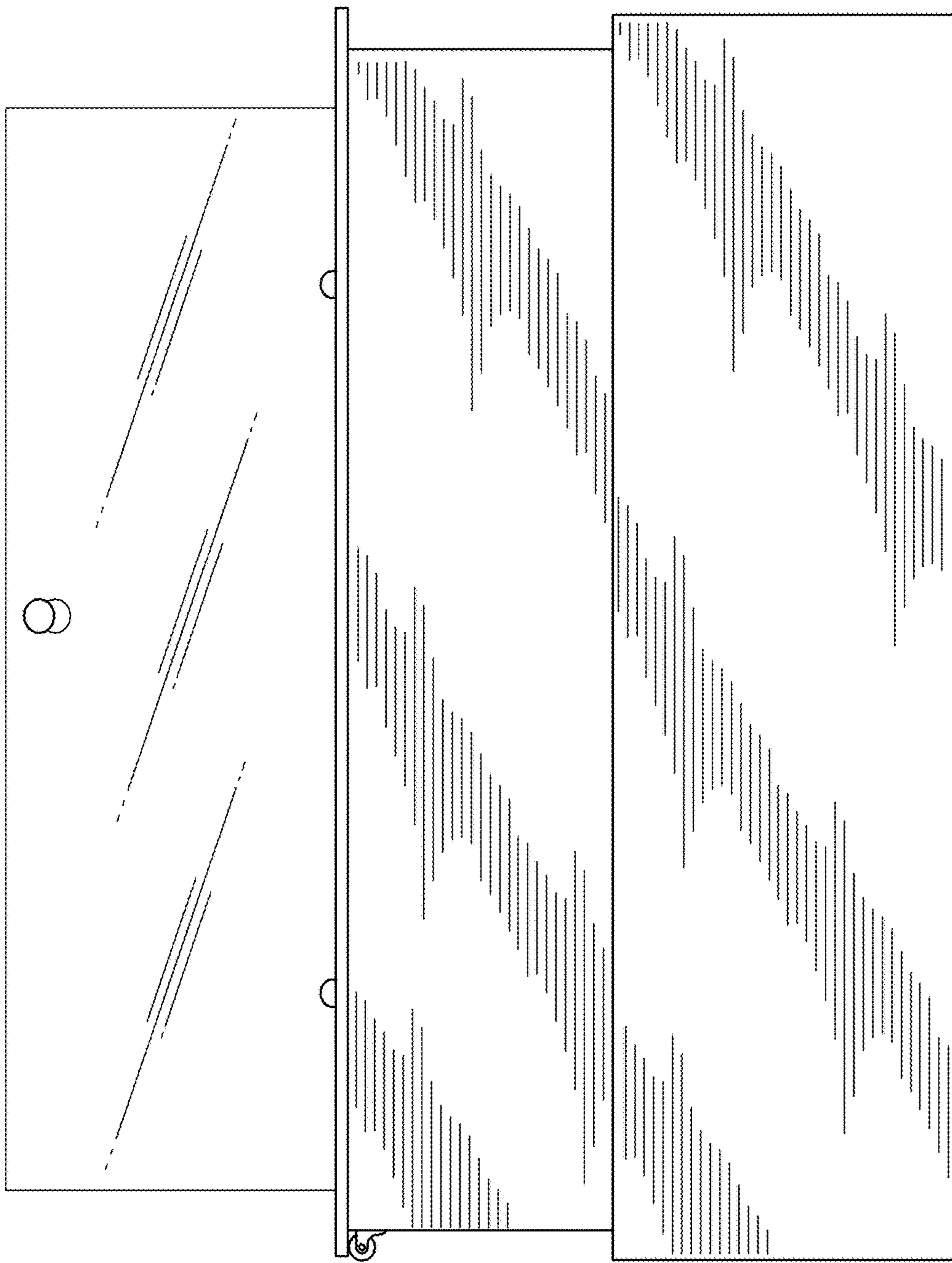

FIG. 26

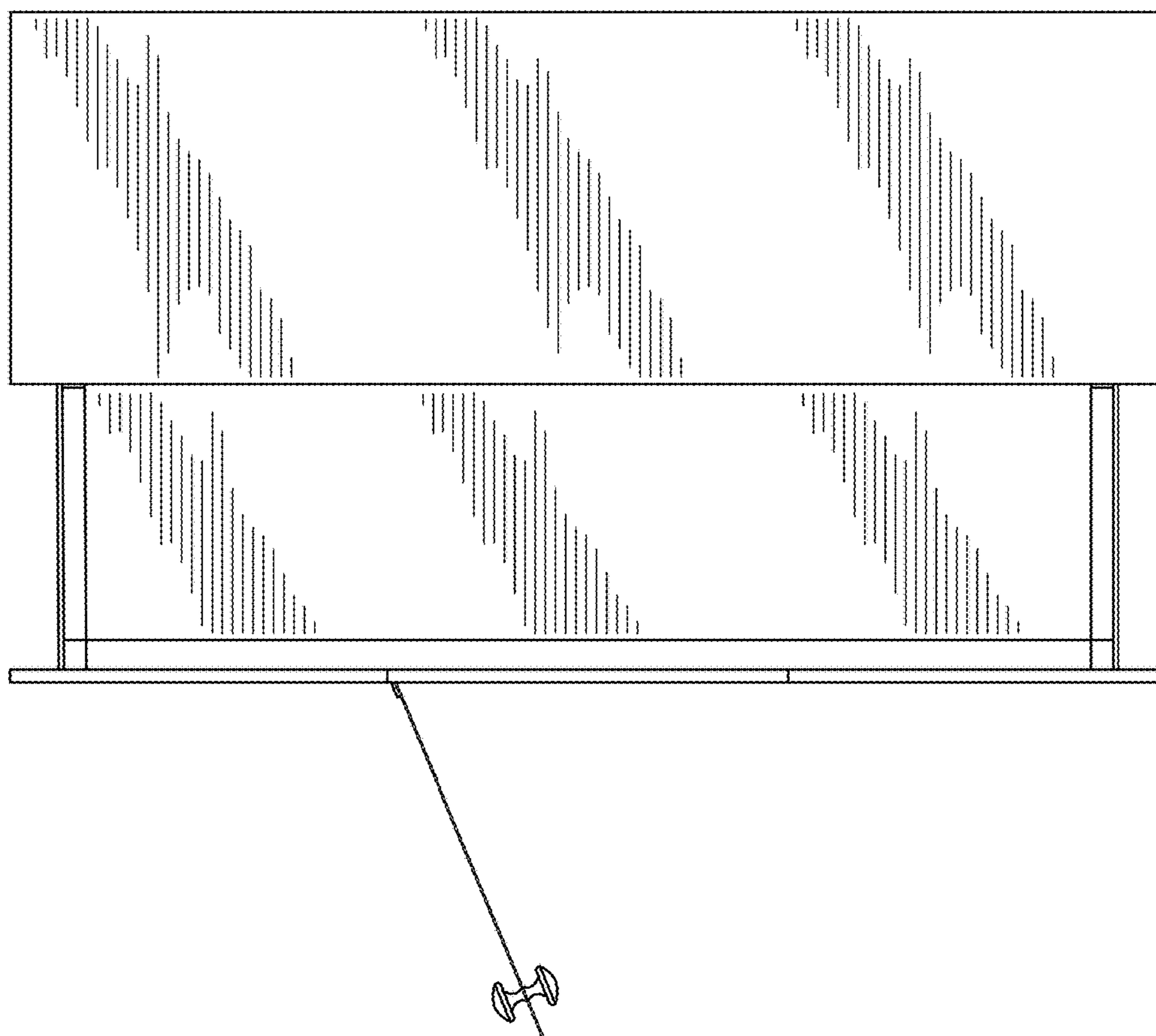

FIG. 27

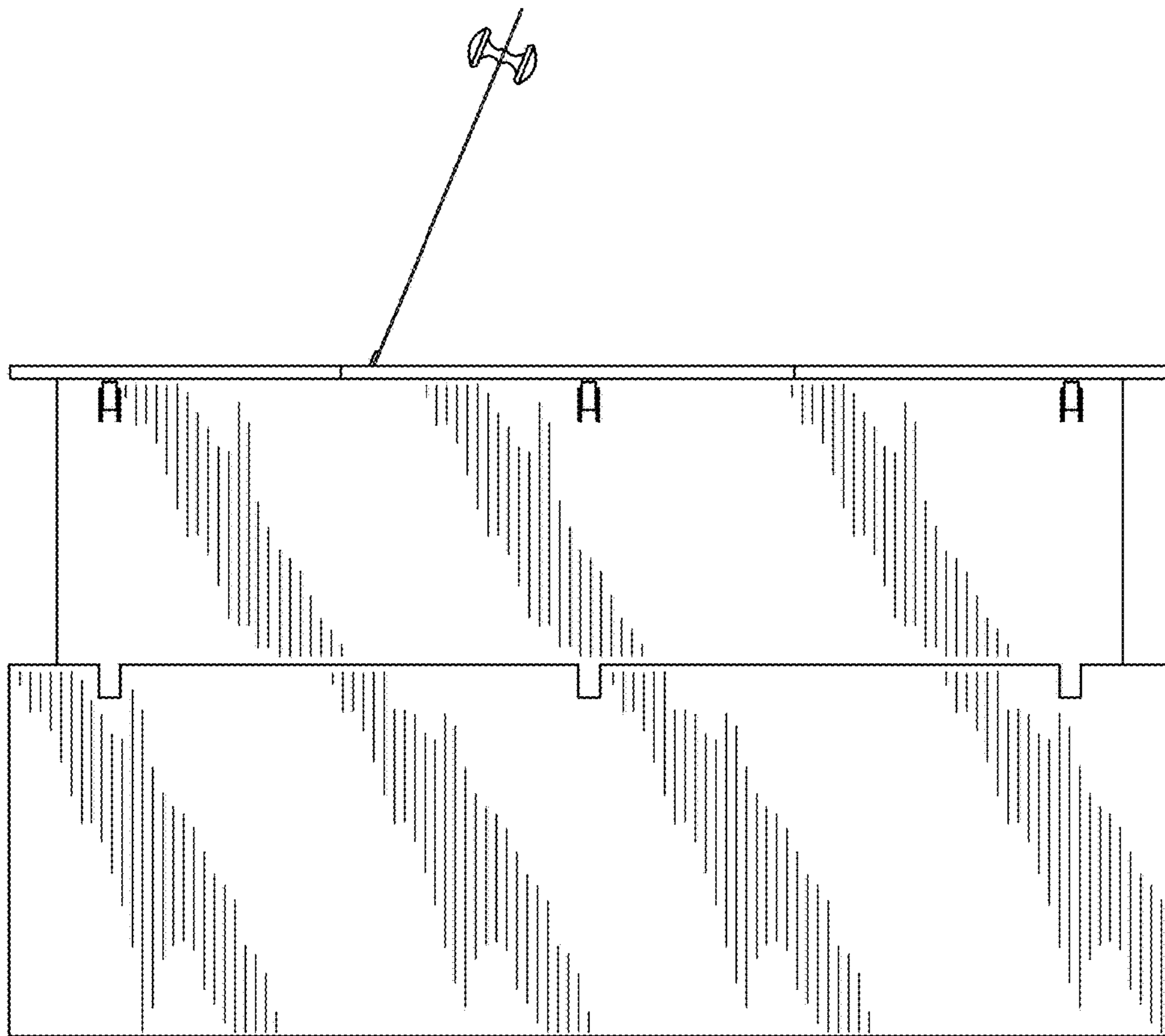

FIG. 28