



US00D779065S

(12) **United States Design Patent** (10) **Patent No.:** **US D779,065 S**
Brotman et al. (45) **Date of Patent:** **** Feb. 14, 2017**

(54) **ANTERIOR CERVICAL BONE PLATE**

FOREIGN PATENT DOCUMENTS

(71) Applicant: **NuVasive, Inc.**, San Diego, CA (US)

AU 201121861 A1 9/2011
CN 2477152 Y 2/2002

(72) Inventors: **Michael Brotman**, San Diego, CA (US); **Andrew Wolf**, San Diego, CA (US); **Paul D. Sawin**, Winter Park, FL (US)

(Continued)

Primary Examiner — Charles Hanson
(74) *Attorney, Agent, or Firm* — Jeremy A. Smith; Bradley Arant Boult Cummings LLP

(73) Assignee: **NuVasive, Inc.**, San Diego, CA (US)

(57) **CLAIM**

The ornamental design for an anterior cervical bone plate, substantially as shown and described.

(**) Term: **14 Years**

DESCRIPTION

(21) Appl. No.: **29/504,658**

(22) Filed: **Oct. 8, 2014**

(51) **LOC (10) Cl.** **24-02**

(52) **U.S. Cl.**
USPC **D24/155**

(58) **Field of Classification Search**
USPC D24/155-157
CPC A61B 17/8061; A61B 17/7059; A61B 17/8052; A61B 17/8605; A61B 17/8085; A61B 17/809; A61B 17/8014; A61B 17/8033; A61B 17/8004; A61B 17/888; A61B 17/842; A61B 17/8023; A61B 17/8009; A61B 17/86; A61B 17/1739; A61B 17/8066; A61B 17/1671; A61B 17/1757; A61B 17/8071; A61B 17/176; A61B 2017/1782; A61B 2017/1775

See application file for complete search history.

FIG. 1 is a perspective view of an anterior bone plate showing our new design;
FIG. 2 is a first side view thereof;
FIG. 3 is a first end view thereof;
FIG. 4 is a top view thereof;
FIG. 5 is a bottom view thereof;
FIG. 6 is a perspective view of a second embodiment of an anterior cervical bone plate;
FIG. 7 is a first side view thereof;
FIG. 8 is a first end view thereof;
FIG. 9 is a top view thereof;
FIG. 10 is a bottom view thereof;
FIG. 11 is a perspective view of a third embodiment of an anterior cervical bone plate;
FIG. 12 is a first side view thereof;
FIG. 13 is a first end view thereof;
FIG. 14 is a top view thereof;
FIG. 15 is a bottom view thereof;
FIG. 16 is a perspective view of a fourth embodiment of an anterior cervical bone plate;
FIG. 17 is a first side view thereof;
FIG. 18 is a first end view thereof;
FIG. 19 is a top view thereof; and,
FIG. 20 is a bottom view thereof.

The broken line showing is included for the purpose of illustrating environment and forms no part of the claimed design.

(56) **References Cited**

U.S. PATENT DOCUMENTS

4,488,543 A 12/1984 Tornier
4,794,918 A 1/1989 Wolter

(Continued)

1 Claim, 12 Drawing Sheets

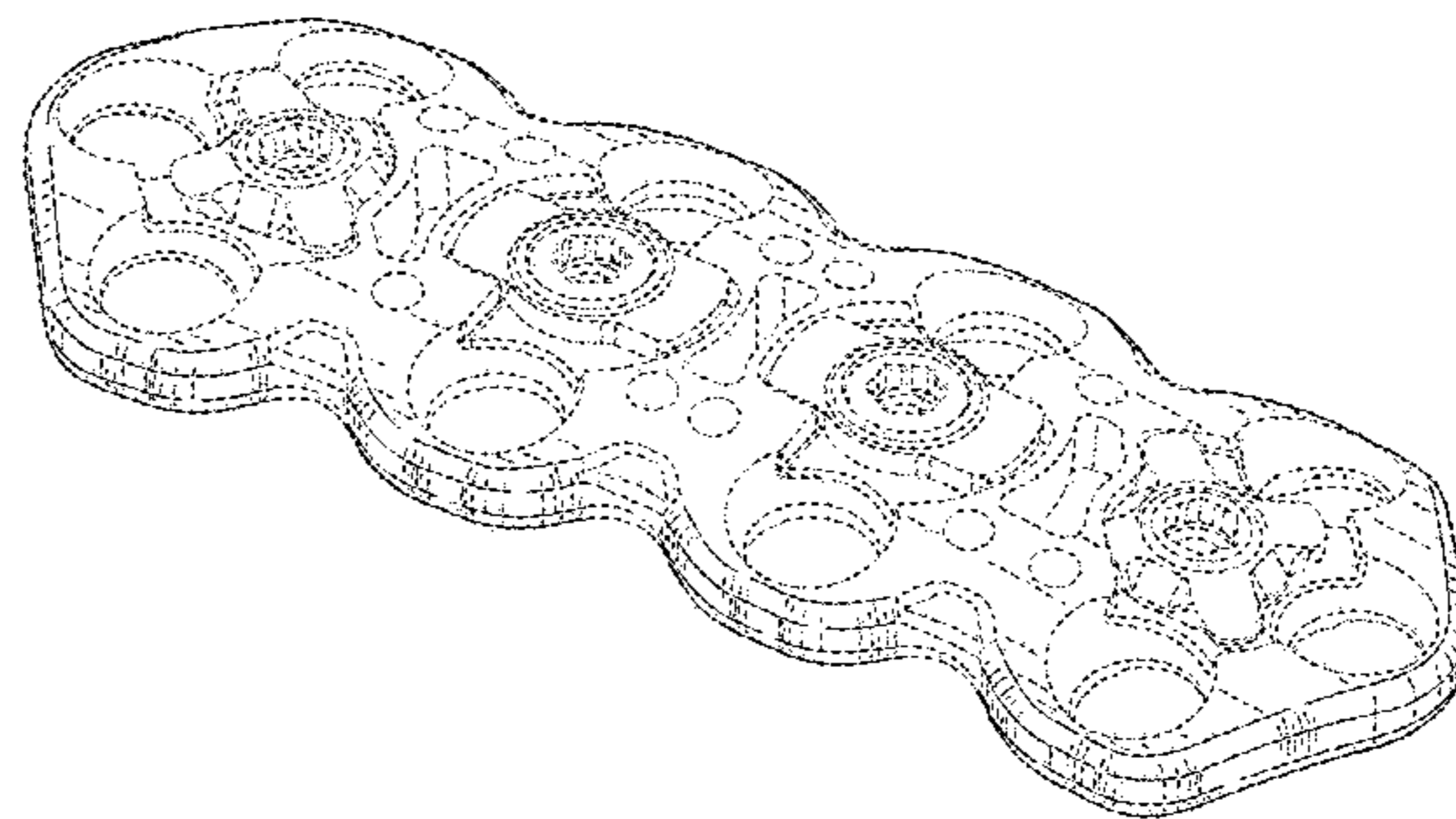
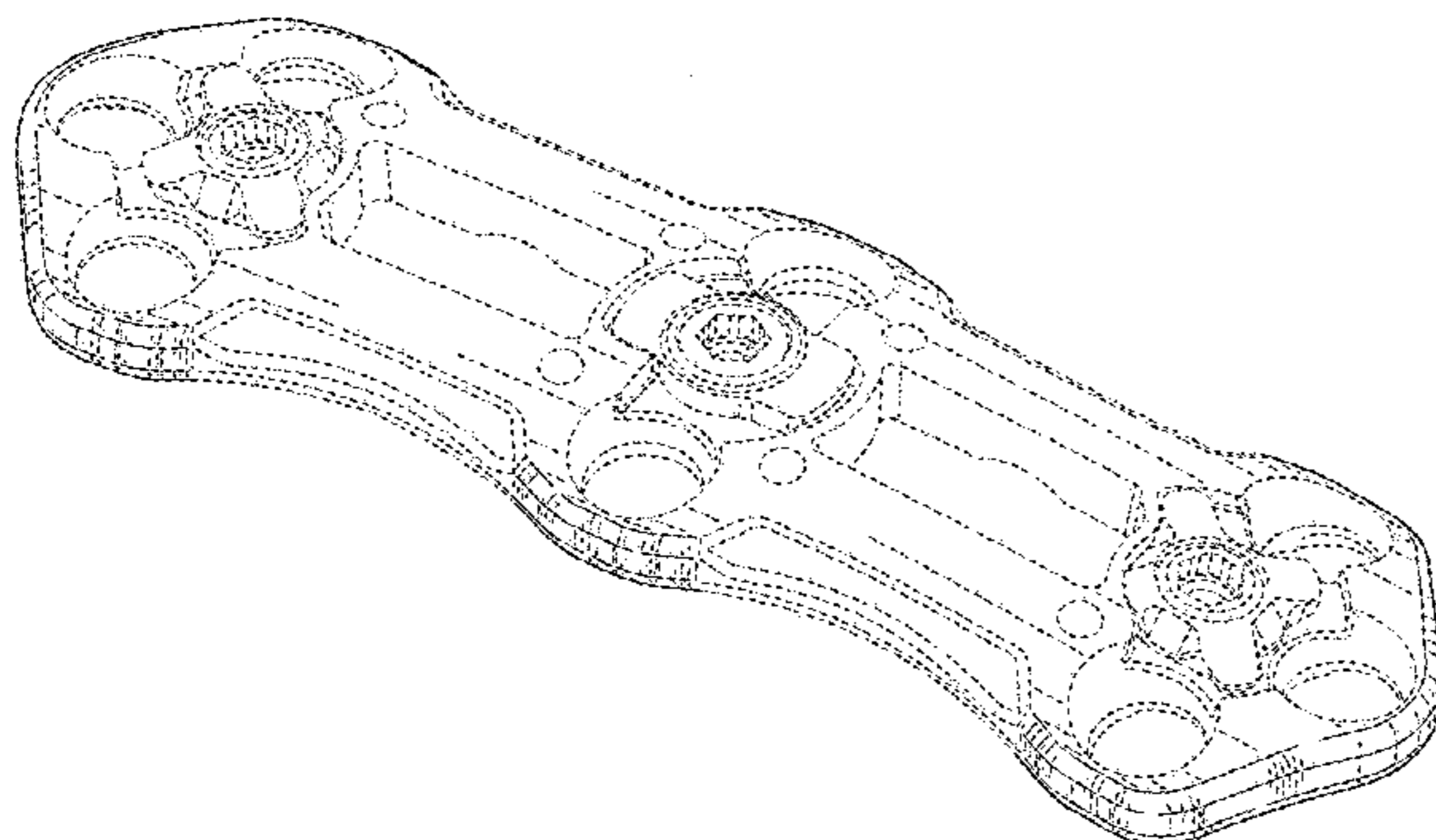

(56)

References Cited

U.S. PATENT DOCUMENTS

5,127,914 A	7/1992	Calderale	D615,652 S *	5/2010	Weiman	D24/155
5,364,399 A	11/1994	Lowery	7,727,266 B2	6/2010	Lindemann	
5,380,324 A	1/1995	Muller	7,740,630 B2	6/2010	Michelson	
5,527,311 A	6/1996	Procter	D622,853 S	8/2010	Raven, III	
5,601,553 A	2/1997	Trebing	7,771,458 B2	8/2010	Biedermann	
5,647,872 A	7/1997	Gilbert	D623,744 S	9/2010	Strnad	
5,681,311 A	10/1997	Foley	D623,751 S *	9/2010	Weiman	D24/155
5,735,853 A	4/1998	Olerud	7,857,839 B2	12/2010	Duong	
5,766,254 A	6/1998	Gelbard	D630,750 S	1/2011	Graham	
5,951,558 A	9/1999	Fiz	7,862,597 B2	1/2011	Gause	
6,136,002 A	10/2000	Shih	7,875,062 B2	1/2011	Lindemann	
6,193,721 B1	2/2001	Michelson	7,883,510 B2	2/2011	Kim	
6,206,883 B1	3/2001	Tunc	7,905,830 B2	3/2011	Stefanchik	
D440,311 S	4/2001	Michelson	7,909,860 B2	3/2011	Rathbun	
6,235,034 B1	5/2001	Bray	7,914,561 B2	3/2011	Konieczynski	
D449,692 S	10/2001	Michelson	7,963,980 B1	6/2011	Freeman	
6,336,930 B1	1/2002	Stalcup	7,963,981 B2	6/2011	Binder	
6,406,478 B1	6/2002	Kuo	D643,927 S *	8/2011	Prasad	D24/155
6,413,259 B1	7/2002	Lyons	7,998,180 B2	8/2011	Erickson	
6,423,069 B1	7/2002	Sellers	8,029,551 B2	10/2011	Running	
6,488,685 B1	12/2002	Manderson	8,052,729 B2	11/2011	Dube	
6,503,250 B2	1/2003	Paul	8,057,521 B2	11/2011	Smisson, III	
6,506,191 B1	1/2003	Joos	8,062,296 B2	11/2011	Orbay	
6,558,423 B1	5/2003	Michelson	8,066,750 B2	11/2011	Oi	
6,623,486 B1	9/2003	Weaver	8,109,934 B2	2/2012	Guenther	
6,669,700 B1	12/2003	Farris	8,114,081 B2	2/2012	Kohut	
6,730,127 B2	5/2004	Michelson	8,162,950 B2	4/2012	Digeser	
6,740,088 B1	5/2004	Kozak	8,167,918 B2	5/2012	Strnad	
6,793,658 B2	9/2004	LeHuec	8,216,312 B2	7/2012	Gray	
6,866,665 B2	3/2005	Orbay	8,257,408 B2	9/2012	Johnson	
6,872,210 B2	3/2005	Hearn	8,273,111 B2	9/2012	Amato	
6,890,335 B2	5/2005	Grabowski	8,287,574 B2	10/2012	Biyani	
6,945,973 B2	9/2005	Bray	8,317,842 B2	11/2012	Graham	
6,989,012 B2	1/2006	LeHuec	8,348,980 B2	1/2013	Prasad	
7,004,944 B2	2/2006	Gause	8,353,939 B2	1/2013	Anderson	
7,041,105 B2	5/2006	Michelson	8,361,074 B2	1/2013	Flandry, Jr.	
7,044,952 B2	5/2006	Michelson	8,394,130 B2	3/2013	Orbay	
7,060,067 B2	6/2006	Needham	8,394,131 B2	3/2013	Wing	
7,081,119 B2	7/2006	Stihl	8,403,969 B2	3/2013	Wallenstein	
7,094,239 B1	8/2006	Michelson	8,419,777 B2	4/2013	Walker	
7,097,645 B2	8/2006	Michelson	8,425,569 B2	4/2013	O'Farrell	
7,118,573 B2	10/2006	Michelson	8,454,667 B2	6/2013	Humphreys	
7,169,150 B2	1/2007	Shipp	8,523,862 B2	9/2013	Murashko, Jr.	
7,250,053 B2	7/2007	Orbay	8,551,144 B2	10/2013	Youssef	
7,282,053 B2	10/2007	Orbay	8,551,145 B2	10/2013	Huddleston, III	
7,288,094 B2	10/2007	Lindemann	8,556,944 B2	10/2013	Dube	
7,288,095 B2	10/2007	Baynham	8,562,655 B2	10/2013	Butler	
7,303,564 B2	12/2007	Freid	8,613,772 B2	12/2013	Bray	
7,306,605 B2	12/2007	Ross	8,685,069 B2	4/2014	Courtney	
7,318,825 B2	1/2008	Butler	8,740,915 B2	6/2014	Niederberger	
D581,055 S	11/2008	Mateyka	8,784,457 B2	7/2014	Graham	
7,481,829 B2	1/2009	Baynham	8,790,378 B2	7/2014	Castaneda	
7,488,327 B2	2/2009	Rathbun	8,808,333 B2	8/2014	Kuster	
D592,946 S	5/2009	Johnson	8,845,697 B2	9/2014	Montello	
7,527,640 B2	5/2009	Ziolo	8,882,813 B2	11/2014	Jones	
7,527,641 B2	5/2009	Suh	8,906,077 B2	12/2014	Bush, Jr.	
D597,673 S	8/2009	Smisson, III	2002/0062127 A1	5/2002	Schumacher	
D598,104 S *	8/2009	Bush, Jr.	2003/0036759 A1	2/2003	Musso	
D602,589 S *	10/2009	Bush, Jr.	2004/0019353 A1	1/2004	Freid	
D603,503 S *	11/2009	Kriska	2004/0097936 A1	5/2004	Ebid	
D603,504 S *	11/2009	Kriska	2004/0153160 A1	8/2004	Carrasco	
D603,505 S *	11/2009	Kriska	2004/0158250 A1	8/2004	Chappuis	
D603,506 S *	11/2009	Kriska	2004/0193155 A1	9/2004	Castaneda	
D603,507 S *	11/2009	Kriska	2005/0015093 A1	1/2005	Suh	
D603,508 S *	11/2009	Kriska	2005/0033430 A1	2/2005	Powers	
D603,509 S *	11/2009	Kriska	2005/0049595 A1	3/2005	Suh	
D603,510 S *	11/2009	Kriska	2005/0101959 A1	5/2005	Mitkovic	
D603,511 S *	11/2009	Kriska	2005/0107795 A1	5/2005	Morris	
D603,961 S *	11/2009	Kriska	2005/0187551 A1	8/2005	Orbay	
D603,962 S *	11/2009	Kriska	2005/0203627 A1	9/2005	Choksey	
D603,963 S *	11/2009	Kriska	2006/0056613 A1	3/2006	Kim	
D603,964 S *	11/2009	Kriska	2006/0122605 A1	6/2006	Suh	
7,625,375 B2	12/2009	Garden	2006/0221247 A1	10/2006	Doyen	
7,674,279 B2	3/2010	Johnson	2006/0235409 A1	10/2006	Blain	
7,686,808 B2	3/2010	Orbay	2006/0293668 A1	12/2006	May	
			2007/0055250 A1	3/2007	Aflatoon	
			2007/0162019 A1	7/2007	Burns	
			2007/0173840 A1	7/2007	Huebner	
			2007/0233108 A1	10/2007	Stalcup	

(56)

References Cited

U.S. PATENT DOCUMENTS

2007/0270849 A1 11/2007 Orbay
 2008/0183172 A1 7/2008 Fritzinger
 2008/0234753 A1 9/2008 Trieu
 2008/0306550 A1 12/2008 Matityahu
 2008/0312699 A1 12/2008 Johnson
 2009/0043341 A1 2/2009 Tyber
 2009/0163960 A1 6/2009 Binder
 2009/0270928 A1 10/2009 Stone
 2009/0287257 A1 11/2009 Hagen
 2009/0287258 A1 11/2009 Vannemreddy
 2010/0016858 A1 1/2010 Michel
 2010/0016901 A1 1/2010 Robinson
 2010/0057127 A1 3/2010 McGuire
 2010/0057134 A1 3/2010 Lowry
 2010/0087871 A1 4/2010 Loyola
 2010/0121383 A1 5/2010 Stanaford
 2010/0152783 A1 6/2010 Borostyankoi
 2011/0264149 A1 10/2011 Pappalardo
 2011/0282389 A1 11/2011 Janice
 2011/0301608 A1 12/2011 Roth
 2012/0022600 A1 1/2012 Overes
 2012/0053587 A1 3/2012 Kiritsis
 2012/0071931 A1 3/2012 Perez-Cruet
 2012/0130496 A1 5/2012 Duffield
 2012/0136392 A1 5/2012 Keegan
 2012/0209334 A1 8/2012 Lewis
 2012/0277803 A1 11/2012 Remesh
 2012/0303031 A1 11/2012 Coceancig
 2013/0006309 A1 1/2013 Lorio
 2013/0018424 A1 1/2013 Subik
 2013/0053895 A1 2/2013 Stoll
 2013/0053898 A1 2/2013 Voisard
 2013/0072988 A1 3/2013 Hulliger
 2013/0211463 A1 8/2013 Mizuno
 2013/0238095 A1 9/2013 Pavento
 2014/0039498 A1 2/2014 Chatain

FOREIGN PATENT DOCUMENTS

CN 2498996 Y 7/2002
 CN 1366866 A 9/2002
 CN 1372869 A 10/2002
 CN 2517396 Y 10/2002
 CN 2543495 Y 4/2003
 CN 2631438 Y 8/2004
 CN 1748655 A 3/2006
 CN 2822542 Y 10/2006
 CN 2882556 Y 3/2007
 CN 200980723 Y 11/2007
 CN 201042458 Y 4/2008
 CN 201055419 Y 5/2008
 CN 201260694 Y 6/2009

CN 201308534 Y 9/2009
 CN 201324284 Y 10/2009
 CN 201586062 U 9/2010
 CN 101953712 A 1/2011
 CN 101972162 A 2/2011
 CN 201759658 U 3/2011
 CN 201831944 U 5/2011
 CN 201847761 U 6/2011
 CN 202044331 U 11/2011
 CN 102362815 A 2/2012
 CN 202223333 U 5/2012
 CN 202342170 U 7/2012
 CN 202409108 U 9/2012
 CN 202409123 U 9/2012
 CN 202409127 U 9/2012
 CN 202568423 U 12/2012
 CN 102846363 A 1/2013
 CN 102871717 A 1/2013
 CN 202665675 U 1/2013
 CN 202843762 U 4/2013
 CN 202843768 U 4/2013
 CN 202859275 U 4/2013
 CN 202892074 U 4/2013
 CN 202942203 U 5/2013
 CN 202982197 U 6/2013
 CN 203107261 U 8/2013
 DE 7915573 U1 5/1979
 DE 8528003 U1 1/1986
 DE 9217768 U1 5/1993
 DE 9217769 U1 5/1993
 DE 9315148 U1 1/1994
 DE 4438264 A1 3/1996
 DE 8213228 U1 1/2000
 DE 10240653 A1 5/2003
 DE 20317651 U1 3/2004
 DE 102006012581 A1 4/2007
 DE 202009008872 U1 9/2009
 DE 202011107822 U1 5/2012
 EP 0542004 A1 5/1993
 EP 1520545 A1 4/2005
 EP 2433580 A1 3/2012
 ES 2078085 T3 12/1995
 FR 2405062 A1 5/1979
 FR 2740674 A1 5/1997
 JP 2010220762 A 10/2010
 JP 2010233915 A 10/2010
 KR 20020010449 A 2/2002
 KR 20050023433 A 3/2005
 KR 20070022261 A 2/2007
 KR 100974498 B1 8/2010
 RU 2011119282 A 11/2012
 WO WO9722306 A1 6/1997
 WO WO2004017837 A2 3/2004
 WO WO2005034780 A1 4/2005
 WO WO2006022644 A1 3/2006

* cited by examiner

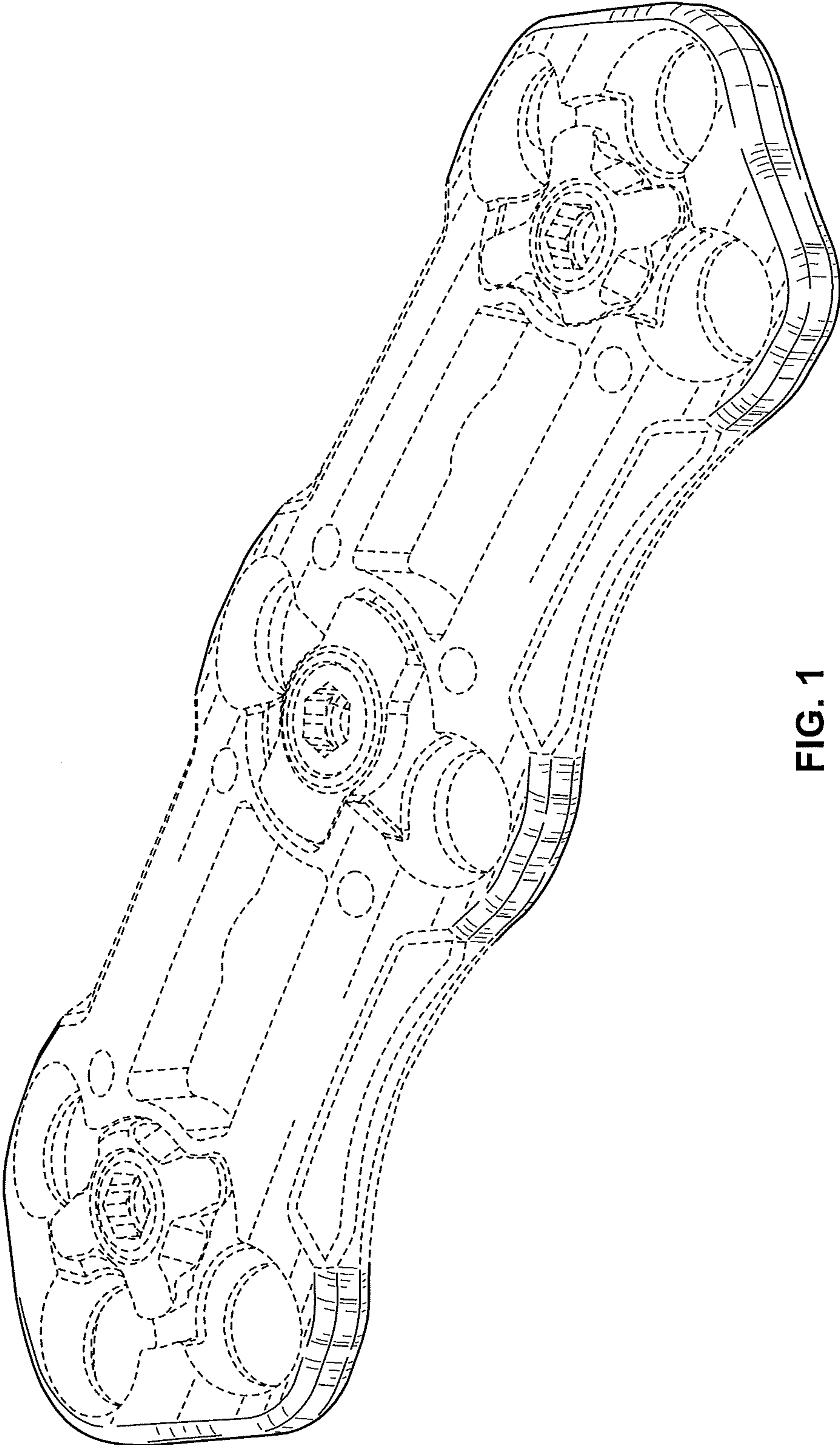

FIG. 1

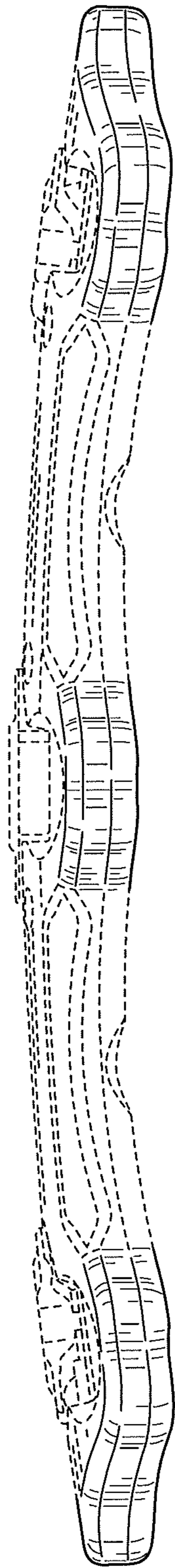

FIG. 2

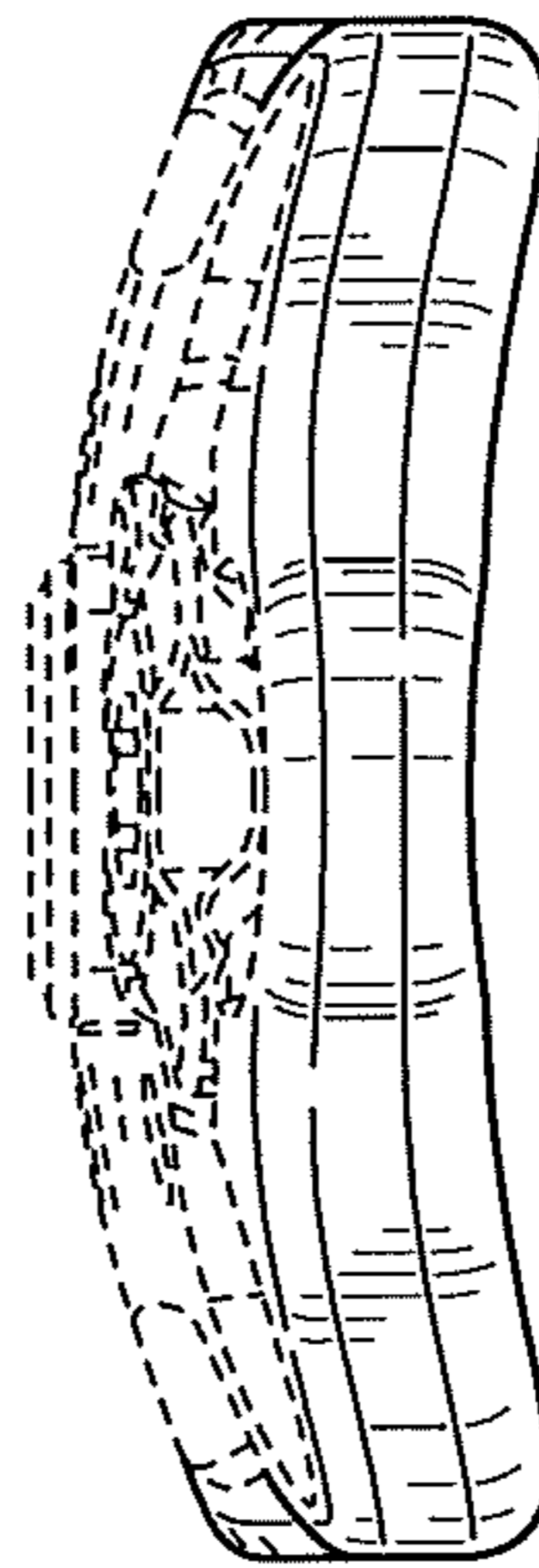

FIG. 3

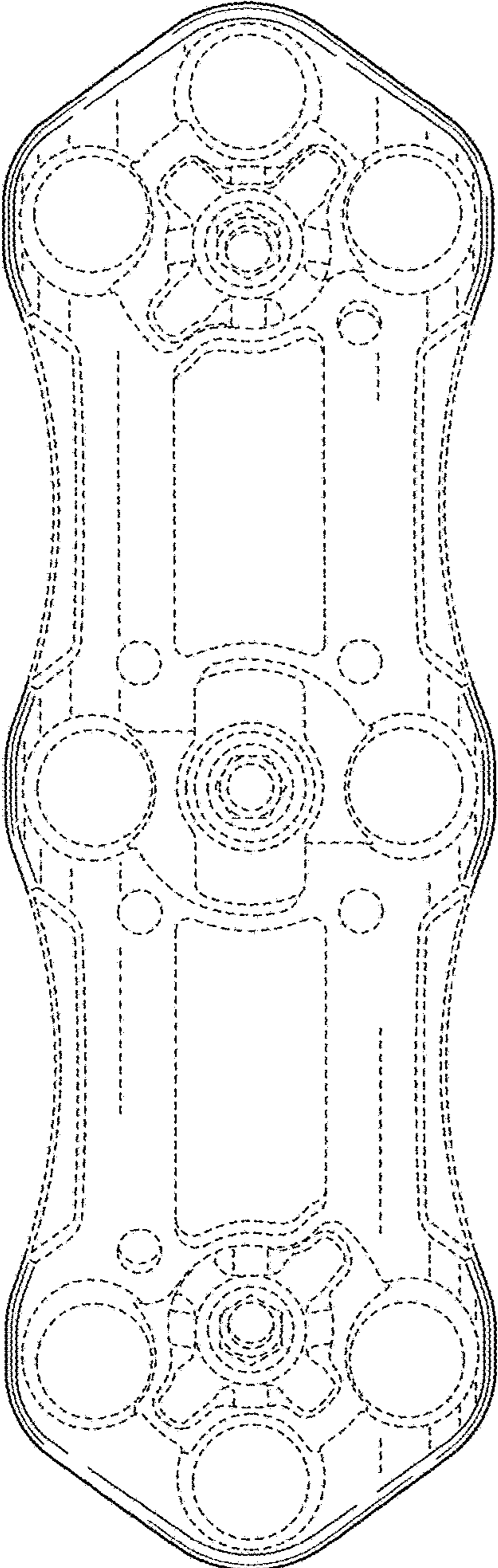

FIG. 4

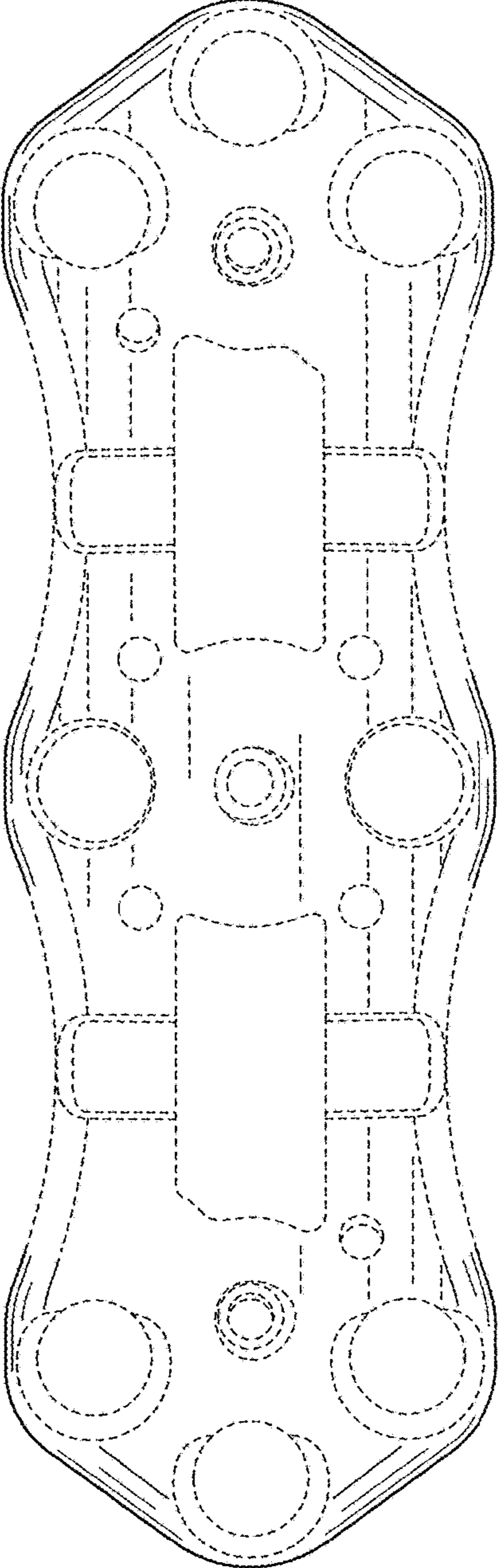

FIG. 5

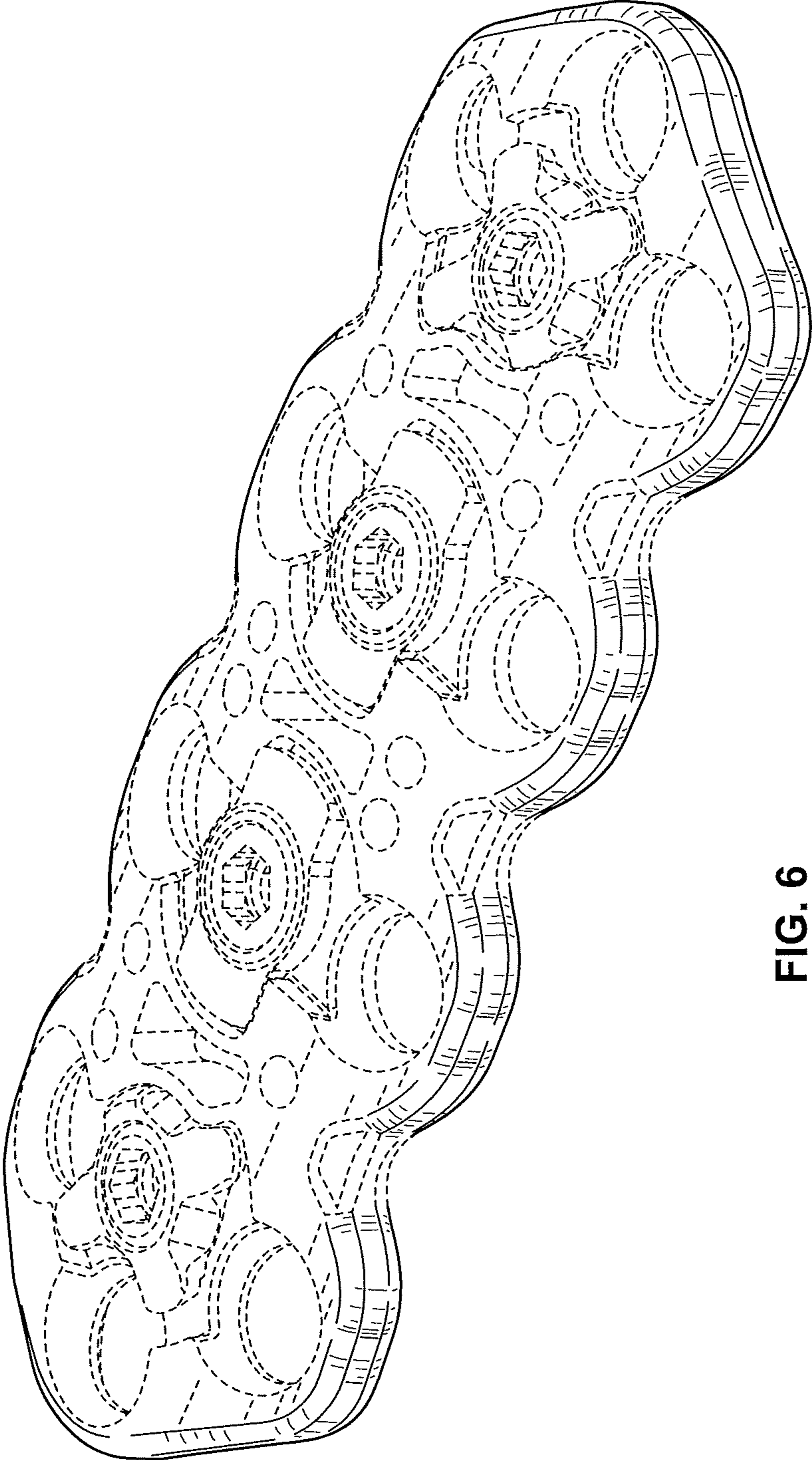

FIG. 6

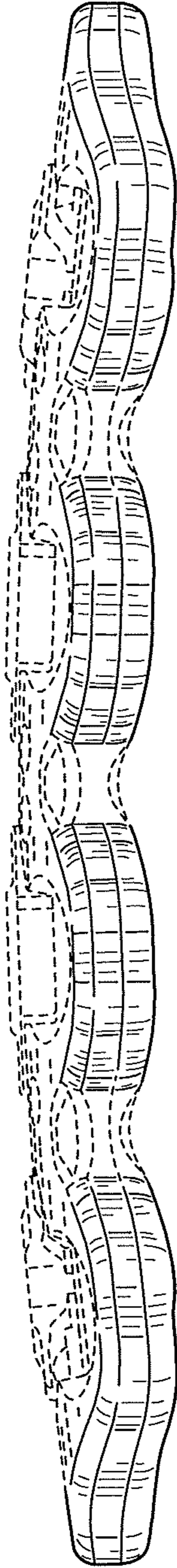

FIG. 7

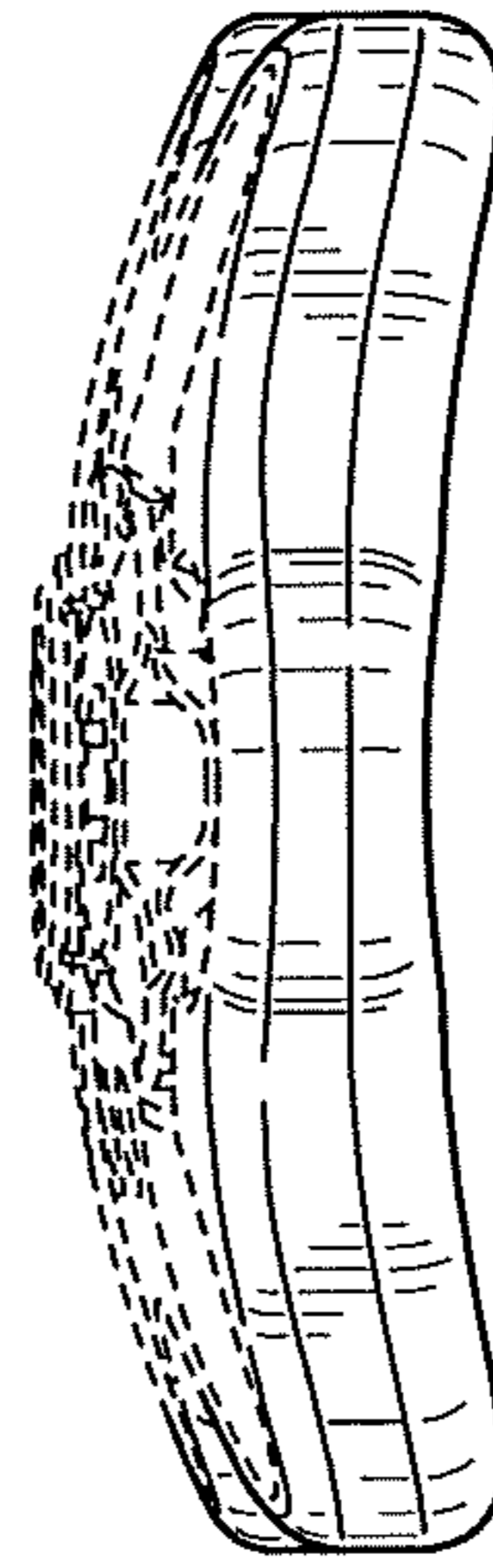

FIG. 8

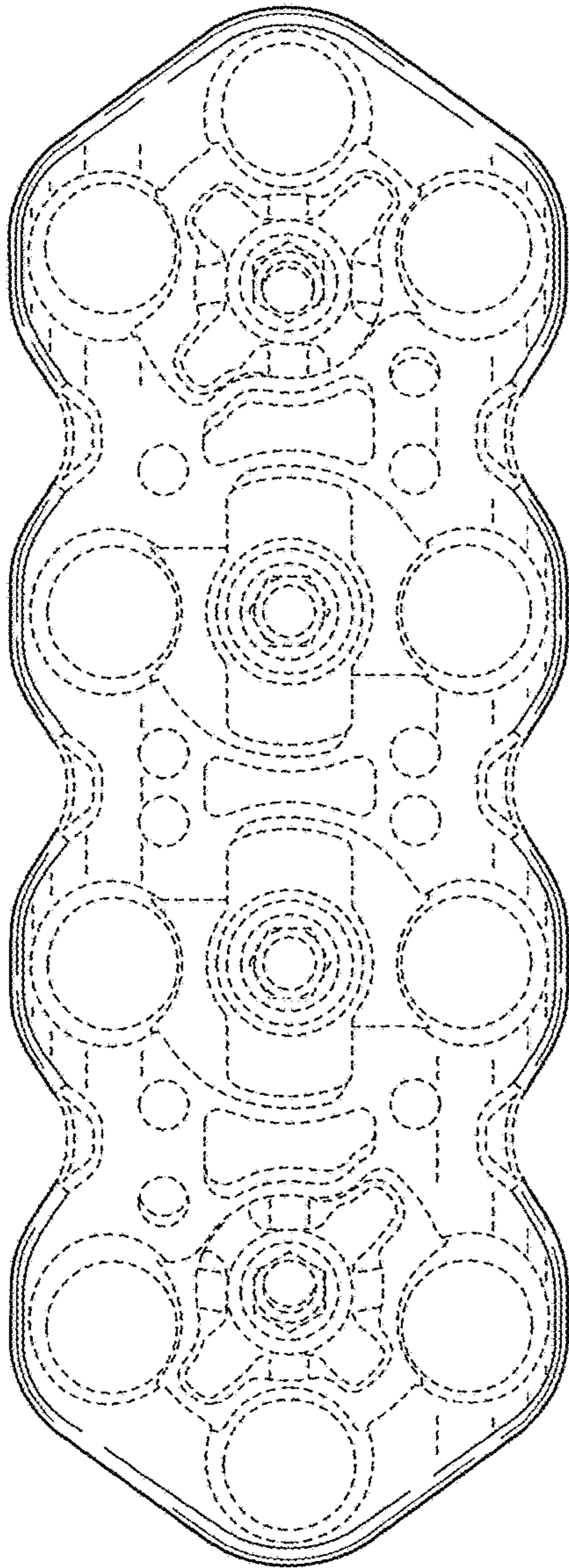

FIG. 9

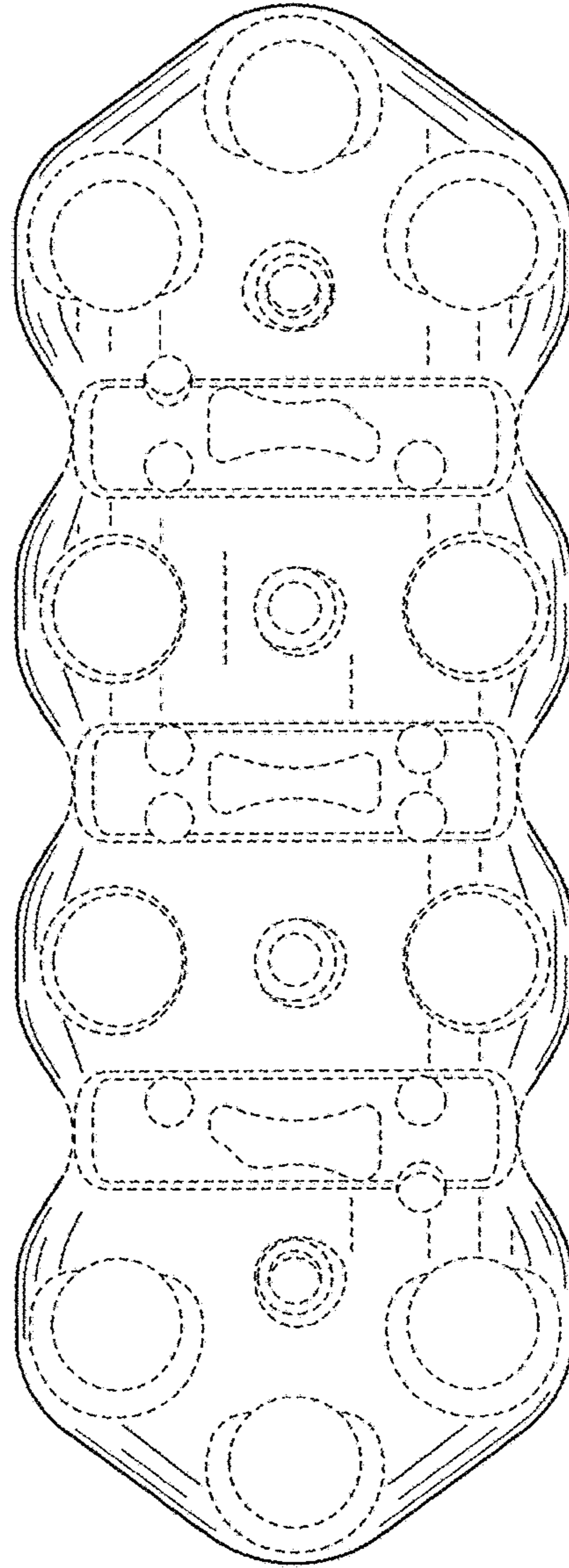

FIG. 10

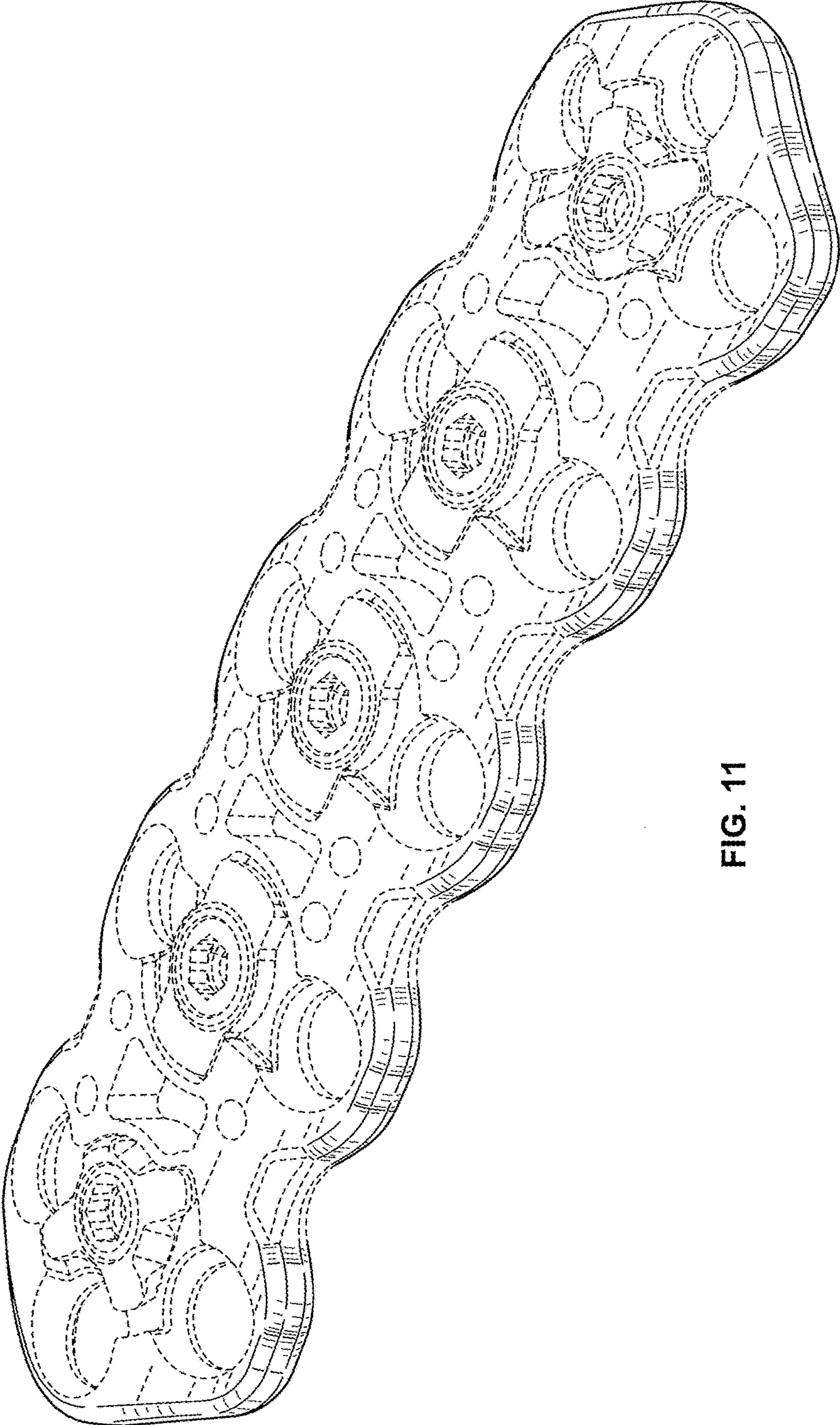

FIG. 11

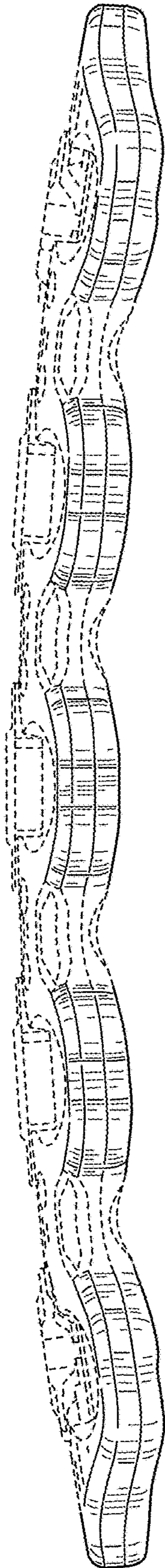

FIG. 12

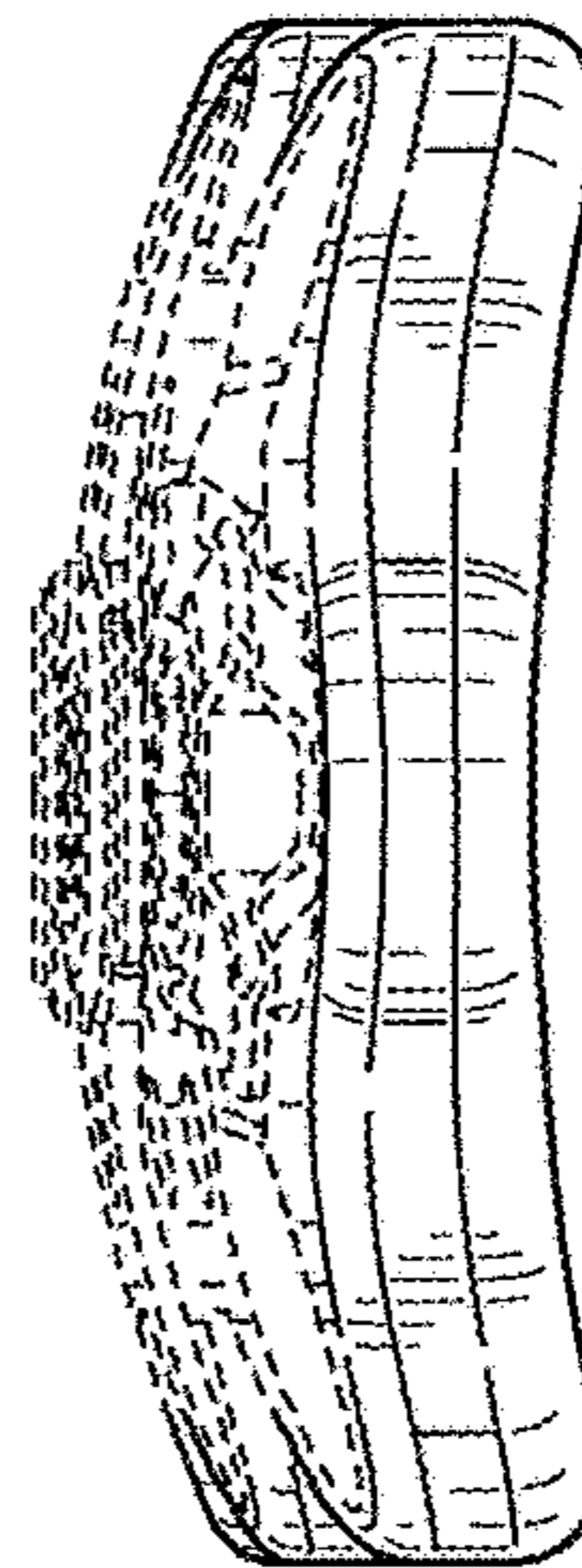

FIG. 13

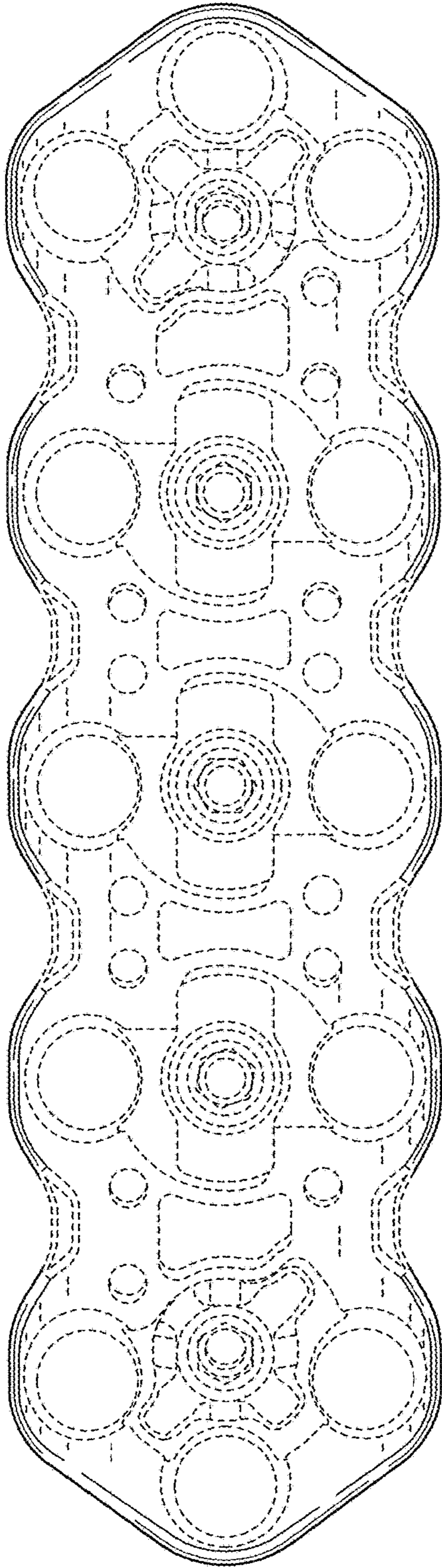

FIG. 14

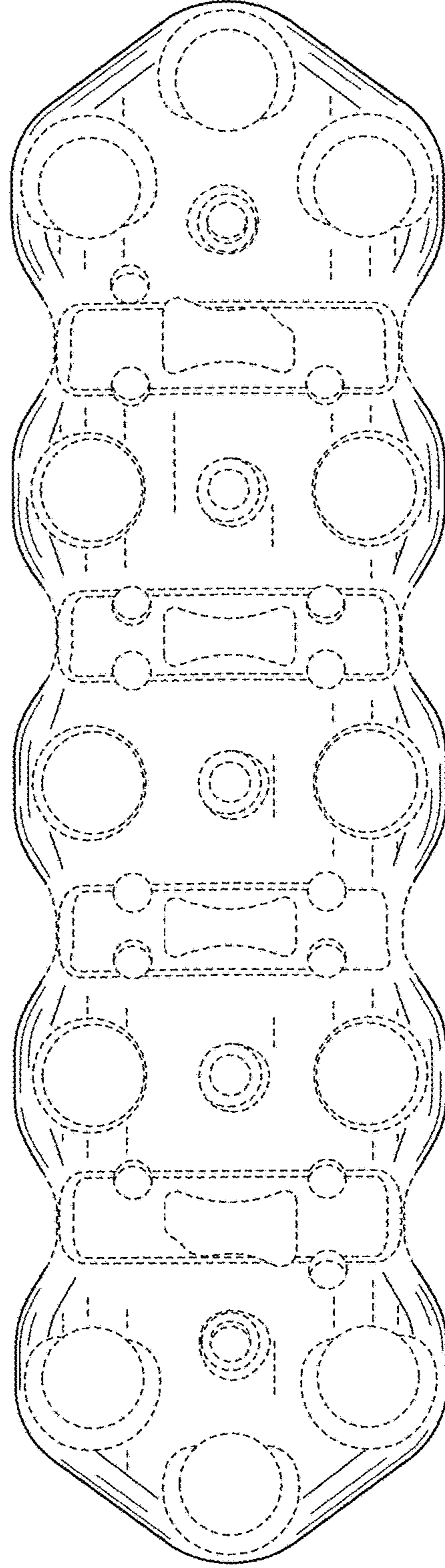

FIG. 15

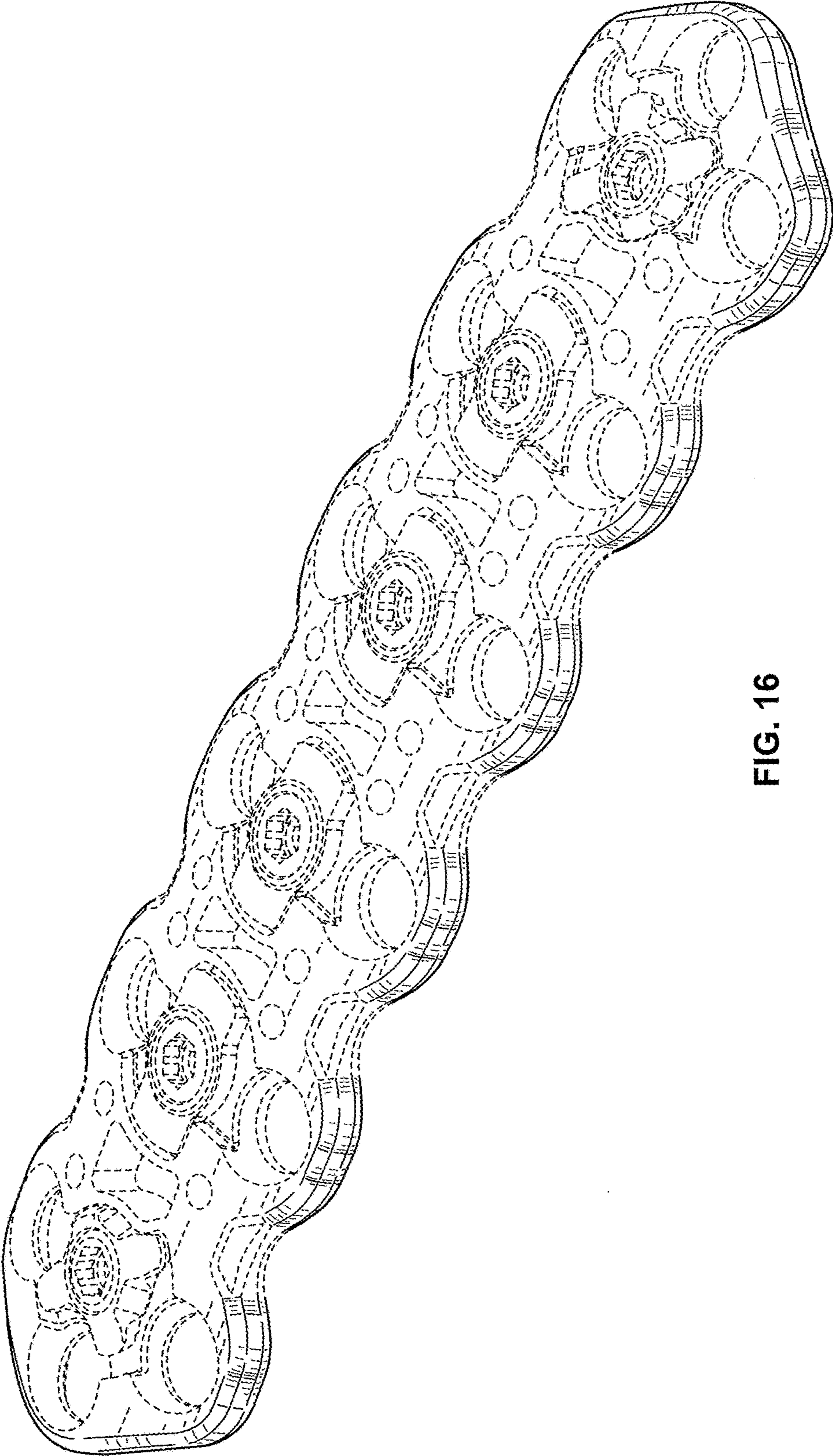

FIG. 16

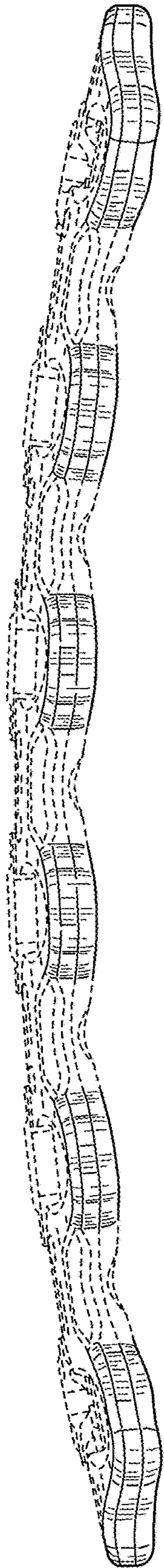

FIG. 17

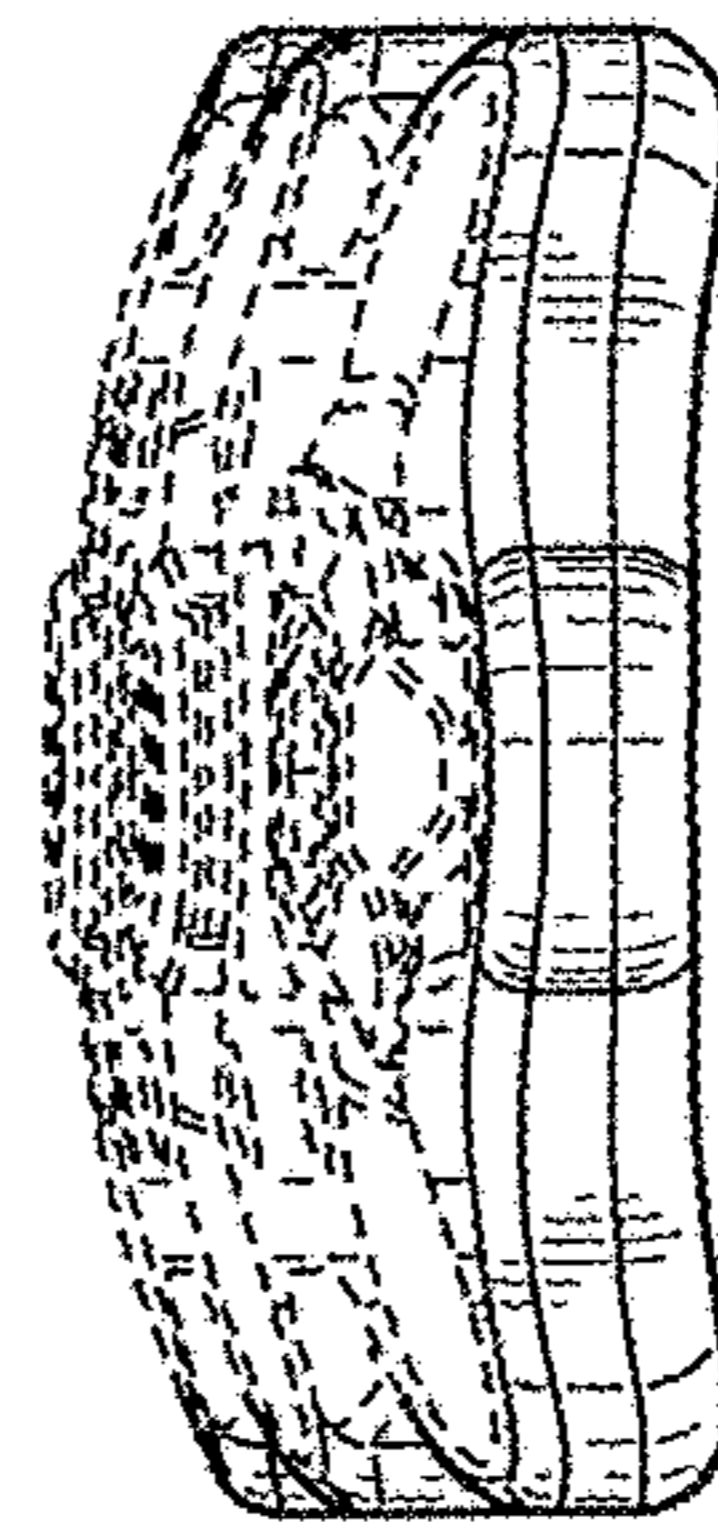

FIG. 18

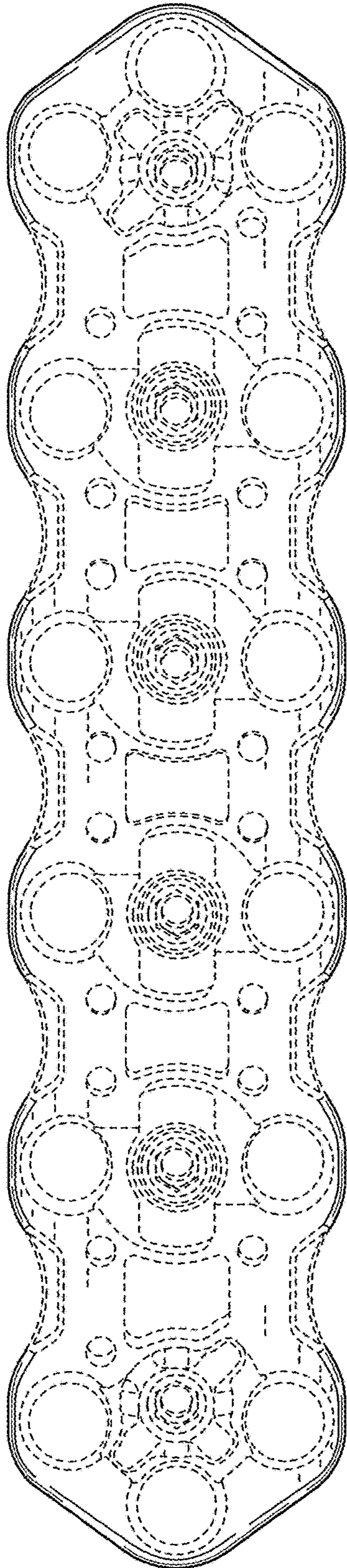

FIG. 19

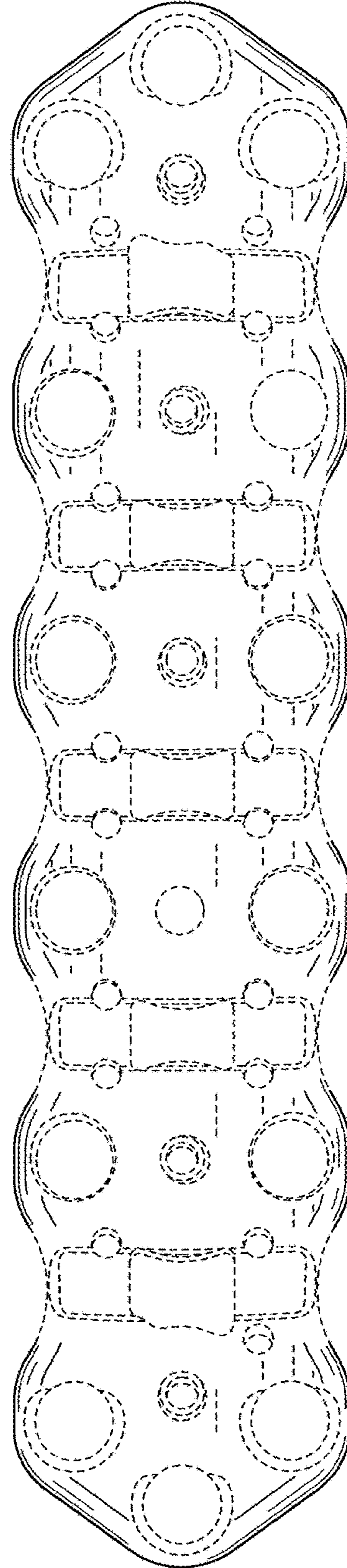

FIG. 20