



US00D778979S

(12) **United States Design Patent** (10) **Patent No.:** **US D778,979 S**  
**Buffa** (45) **Date of Patent:** **\*\* Feb. 14, 2017**

(54) **TEMPLES FOR SPECTACLES**

(74) *Attorney, Agent, or Firm* — Pearne & Gordon LLP

(71) Applicant: **LUXOTTICA S.R.L.**, Agordo (Belluno) (IT)

(57) **CLAIM**

The ornamental design for temples for spectacles, as shown and described.

(72) Inventor: **Federico Gianluigi Buffa**, San Gillio (IT)

**DESCRIPTION**

(73) Assignee: **LUXOTTICA S.R.L.**, Agordo (IT)

FIG. 1 is a perspective view of a first embodiment of temples for spectacles, showing my new design;

(\*\*) Term: **14 Years**

FIG. 2 is a front view thereof;

(21) Appl. No.: **29/454,278**

FIG. 3 is a left side view thereof;

(22) Filed: **May 8, 2013**

FIG. 4 is a top plan view thereof;

(30) **Foreign Application Priority Data**

FIG. 5 is a bottom plan view thereof;

Dec. 11, 2012 (EM) ..... 001354344-01/09

FIG. 6 is a rear view thereof;

(51) **LOC (10) Cl.** ..... **16-06**

FIG. 7 is a perspective view of a second embodiment of temples for spectacles, according to the invention;

(52) **U.S. Cl.**

FIG. 8 is a front view thereof;

USPC ..... **D16/335**; D16/315

FIG. 9 is a left side view thereof;

(58) **Field of Classification Search**

FIG. 10 is a top plan view thereof;

USPC ..... D16/101, 300–342, 900; D29/109–110; 351/41, 44, 51–52, 62, 158, 92, 103–123, 351/140–153, 63, 59, 45–48; 2/426–432, 2/447–449, 441, 434–437, 440, 442, 13, 2/15; D21/483, 659–661; D14/372

FIG. 11 is a bottom plan view thereof;

CPC ..... G02C 2200/08; G02C 1/06; G02C 5/14; G02C 11/02; G02C 11/04; G01C 5/16; A61M 2021/0044; A63B 33/002

FIG. 12 is a rear view thereof;

See application file for complete search history.

FIG. 13 is an “internal” left side view thereof;

(56) **References Cited**

FIG. 14 is a perspective view of a third embodiment of temples for spectacles, according to the invention;

**U.S. PATENT DOCUMENTS**

1,885,014 A \* 10/1932 Jacobson ..... 351/151  
D127,270 S \* 5/1941 Engler ..... D16/316

FIG. 15 is a front view thereof;

(Continued)

FIG. 16 is a left side view thereof;

FIG. 17 is a top plan view thereof;

FIG. 18 is a bottom plan view thereof;

FIG. 19 is a rear view thereof;

FIG. 20 is a perspective view of a fourth embodiment of temples for spectacles, according to the invention;

FIG. 21 is a front view thereof;

FIG. 22 is a left side view thereof;

FIG. 23 is a top plan view thereof;

FIG. 24 is a bottom plan view thereof; and,

FIG. 25 is a rear view thereof.

The material shown in broken lines is for illustrative purposes only and forms no part of the claimed design.

*Primary Examiner* — Raphael Barkai

**1 Claim, 10 Drawing Sheets**

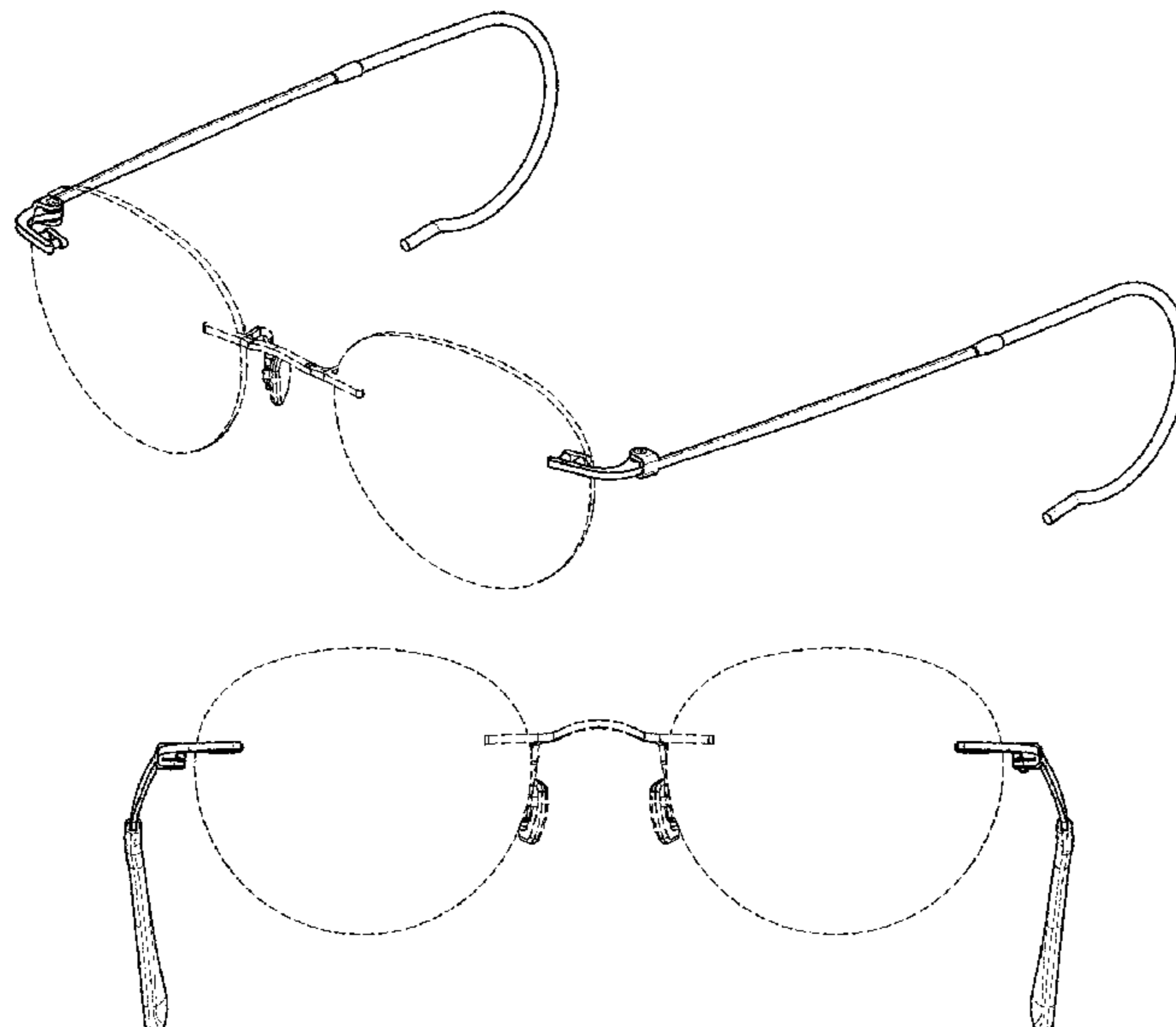

(56)

**References Cited**

U.S. PATENT DOCUMENTS

D154,361 S *	7/1949	Barbour .....	D16/316
D455,451 S *	4/2002	Onodera .....	D16/315
6,729,725 B1 *	5/2004	Cheng .....	351/110
D536,723 S *	2/2007	Mouclier .....	D16/335
7,794,080 B2 *	9/2010	Zelazowski .....	351/153
D638,873 S *	5/2011	Fuchs .....	D16/315
D661,723 S *	6/2012	Fuchs .....	D16/335
D662,535 S *	6/2012	Raile .....	D16/316
D664,187 S *	7/2012	Raile .....	D16/316

\* cited by examiner

FIG.1

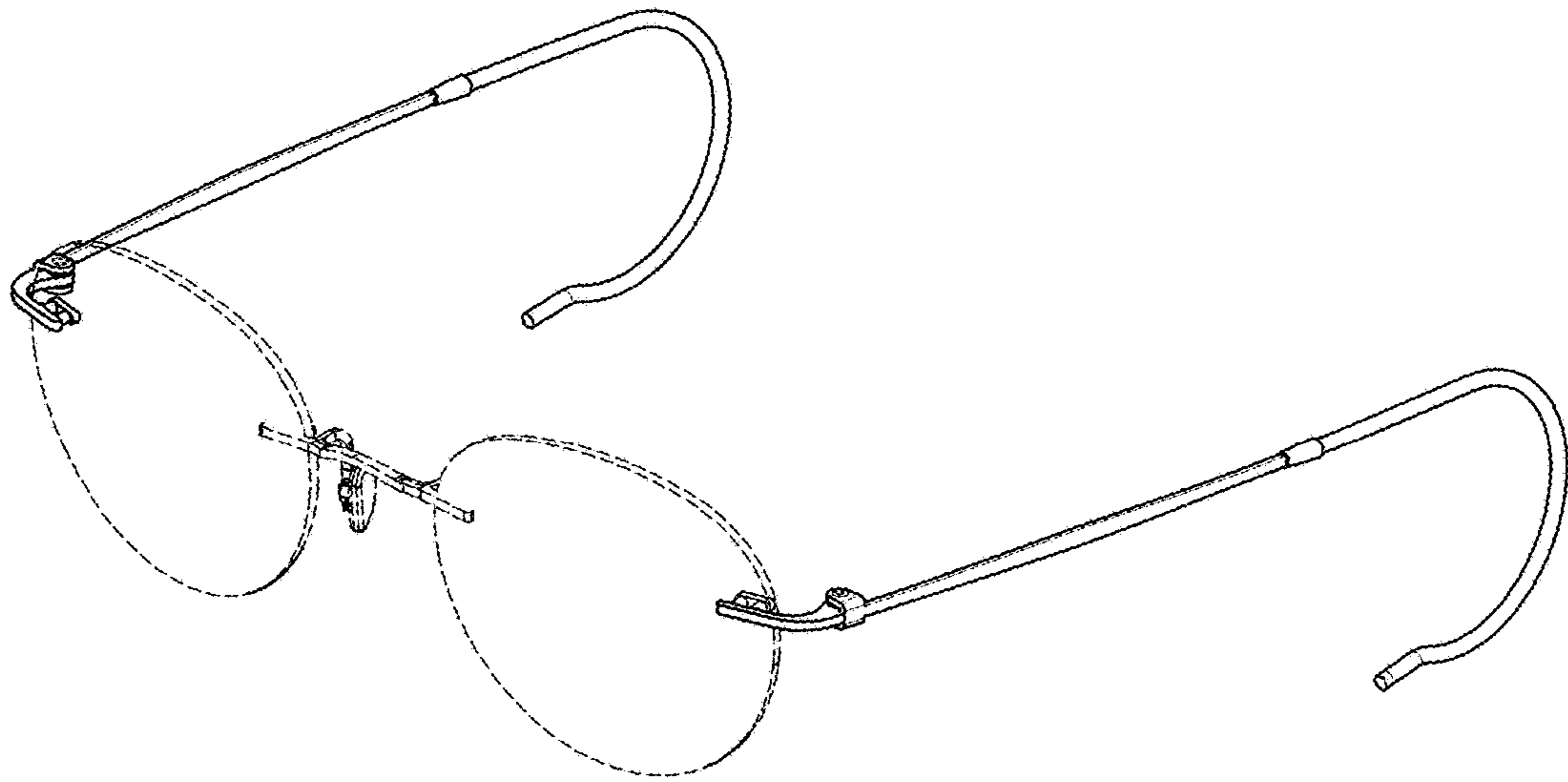

FIG.2

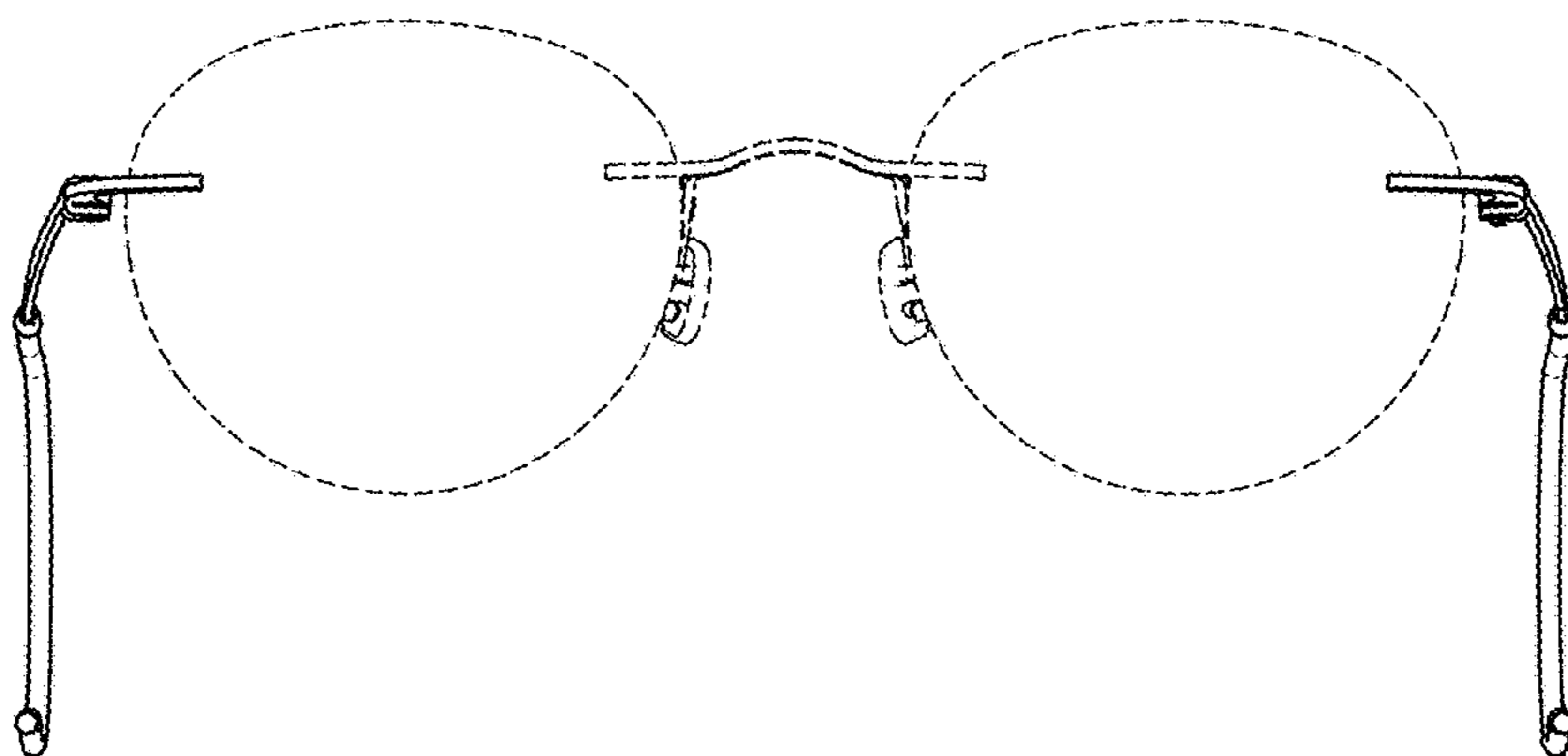

FIG.3

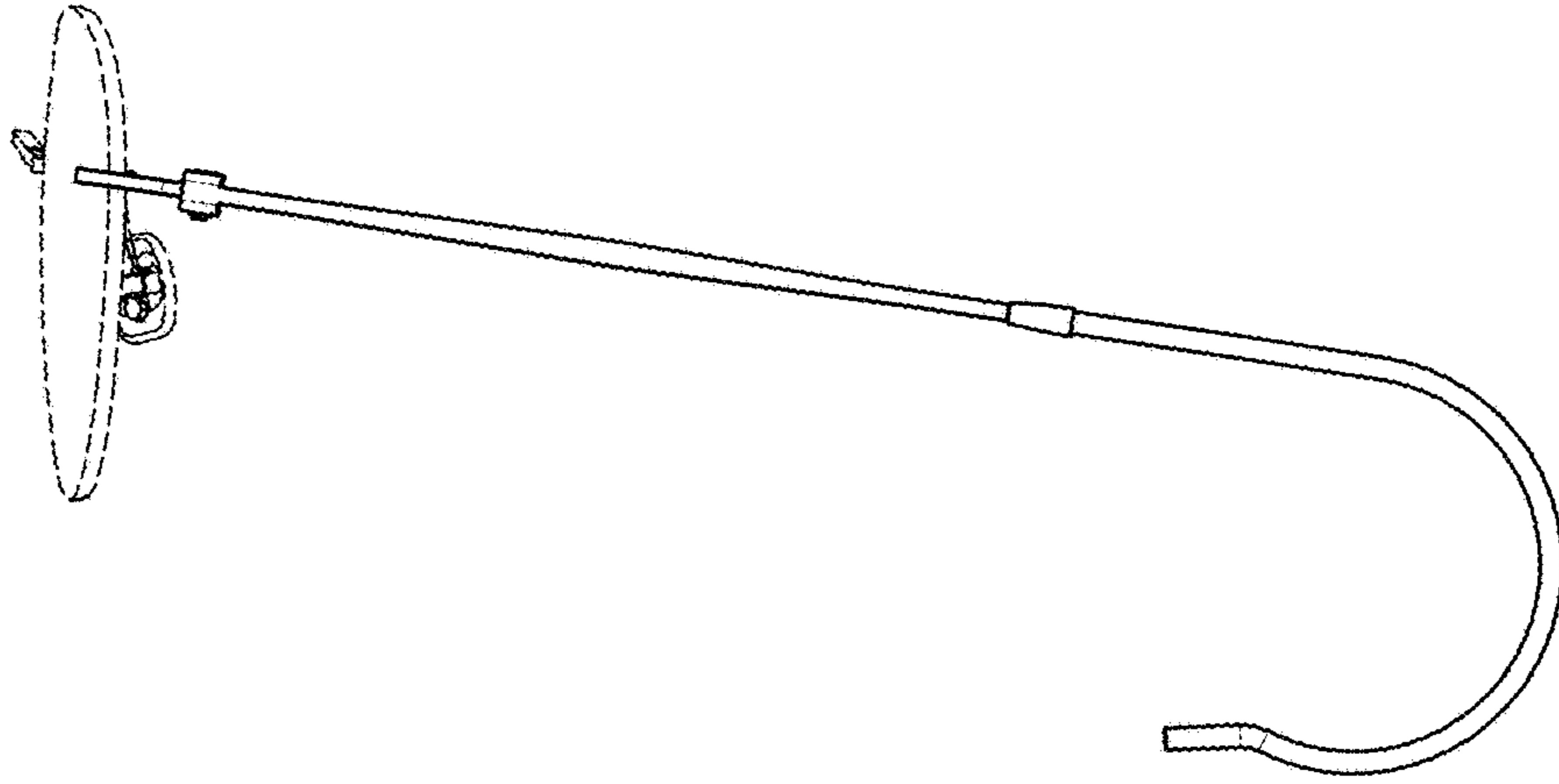

FIG.4

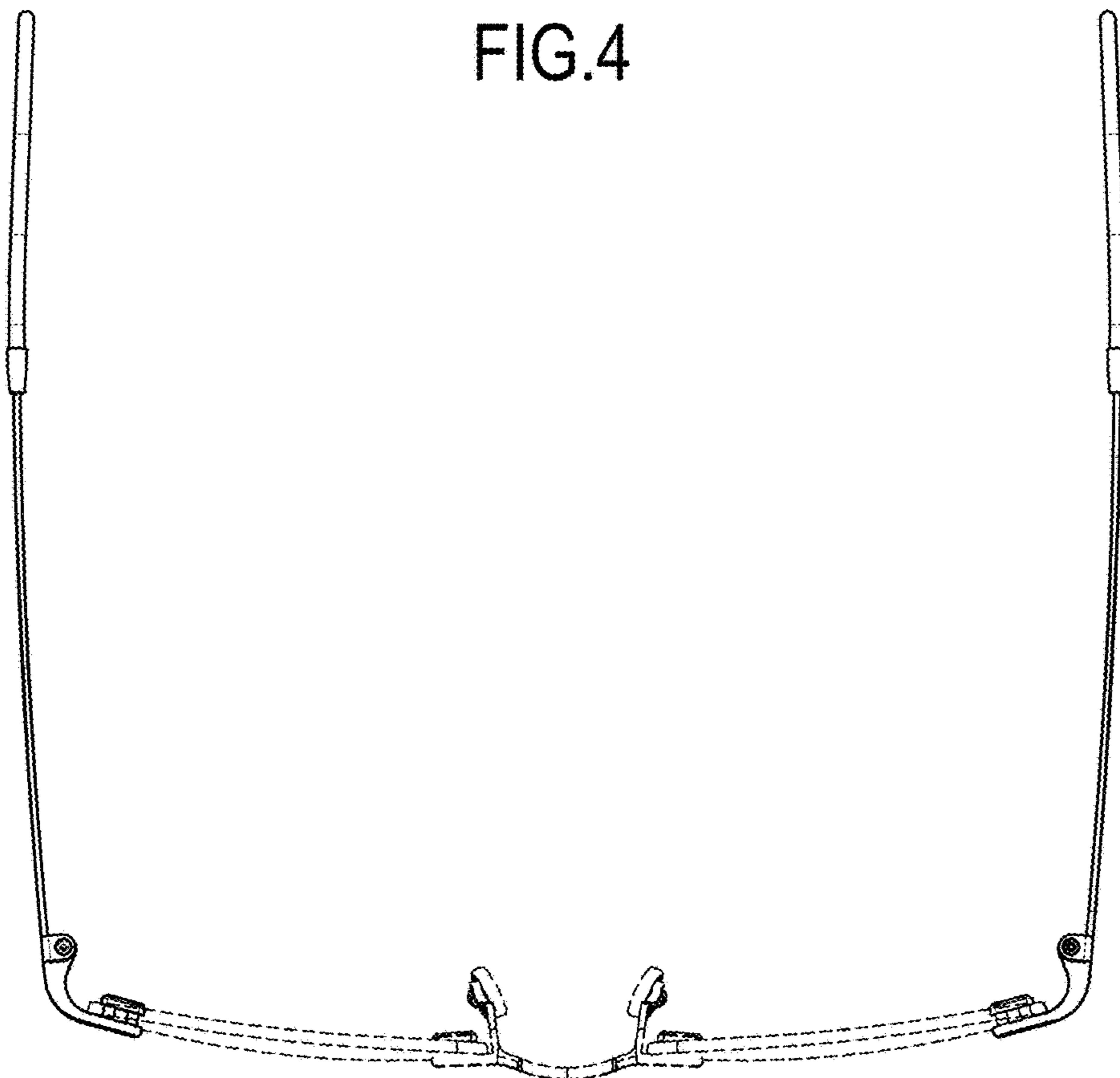

FIG.5

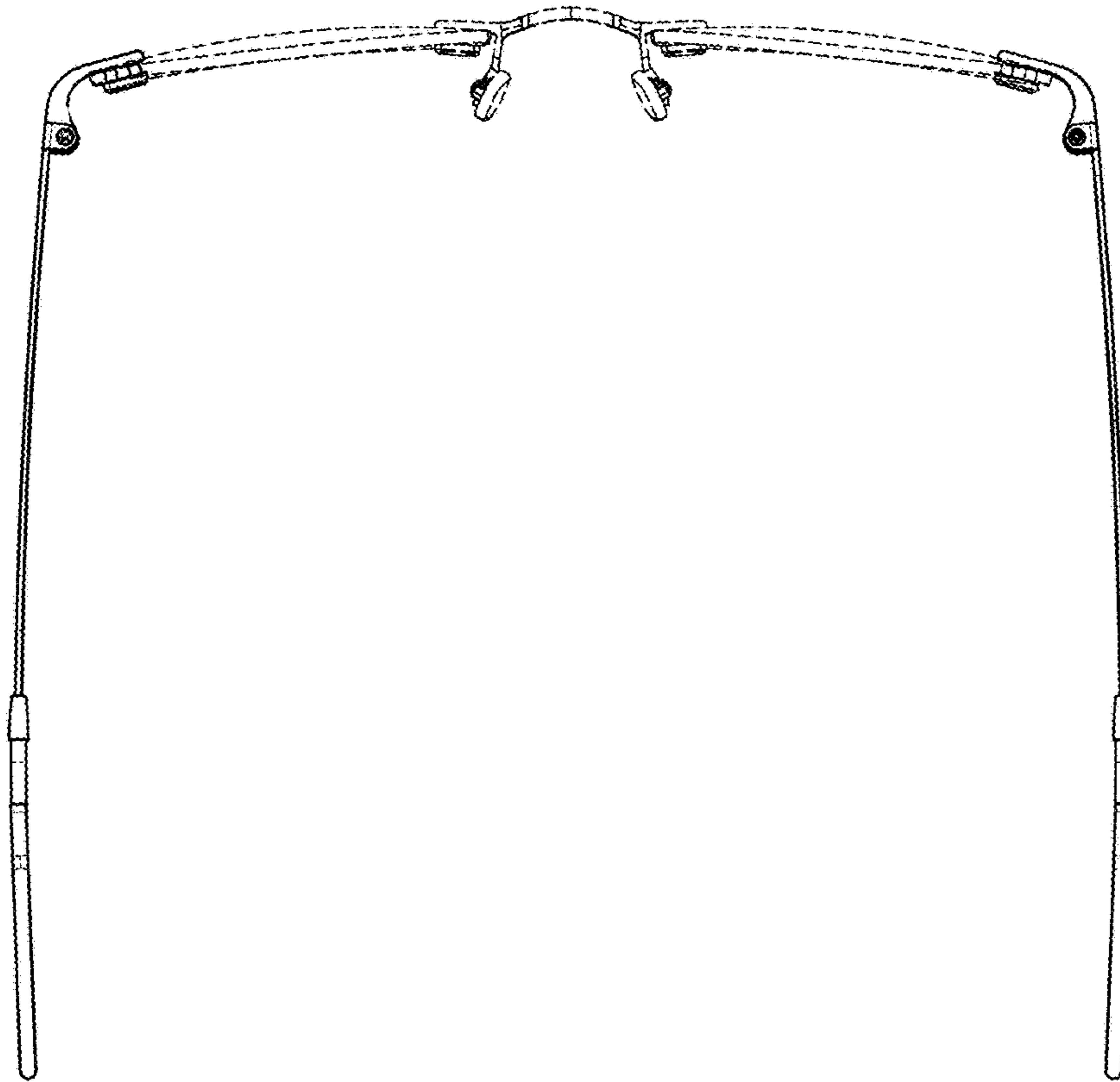

FIG.6

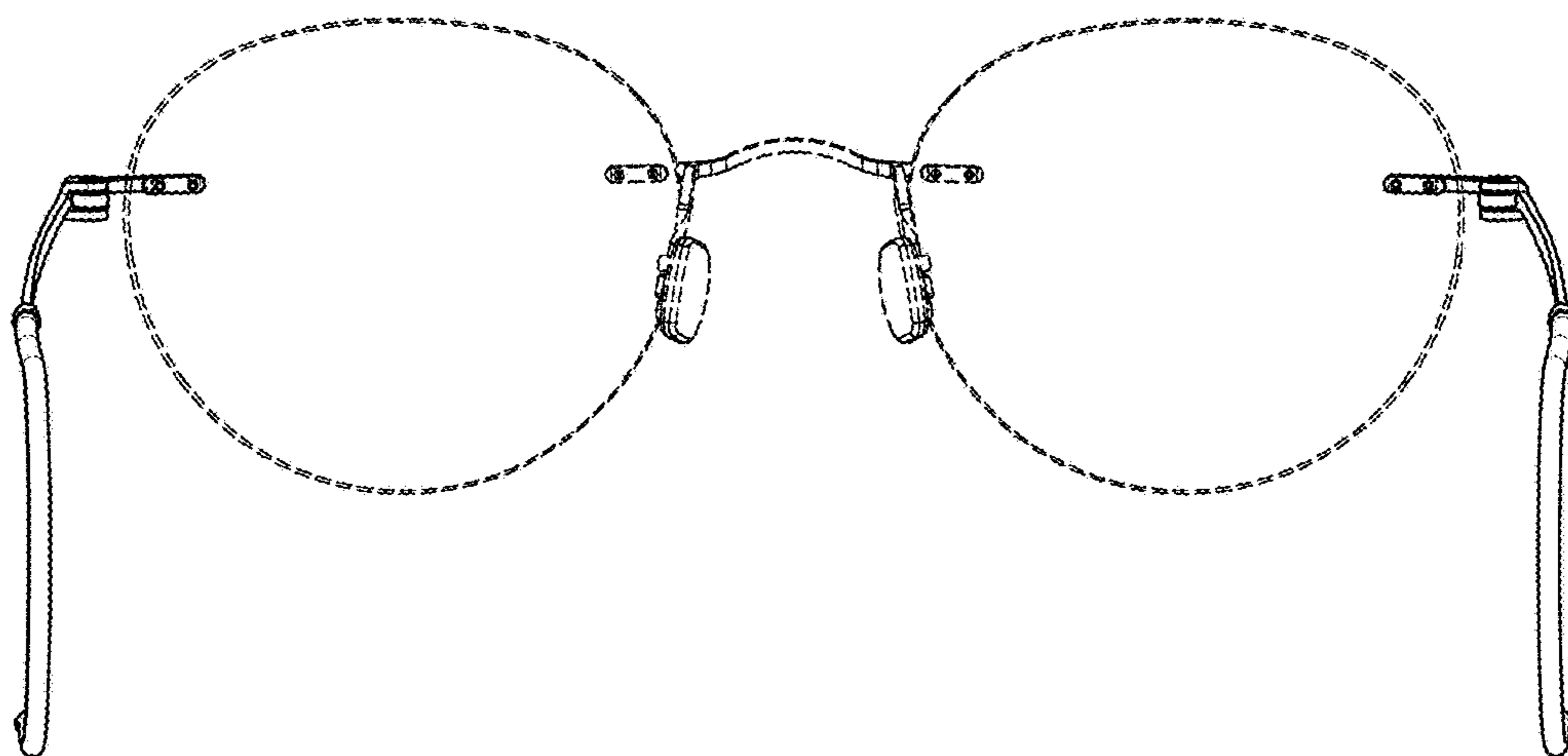

FIG.7

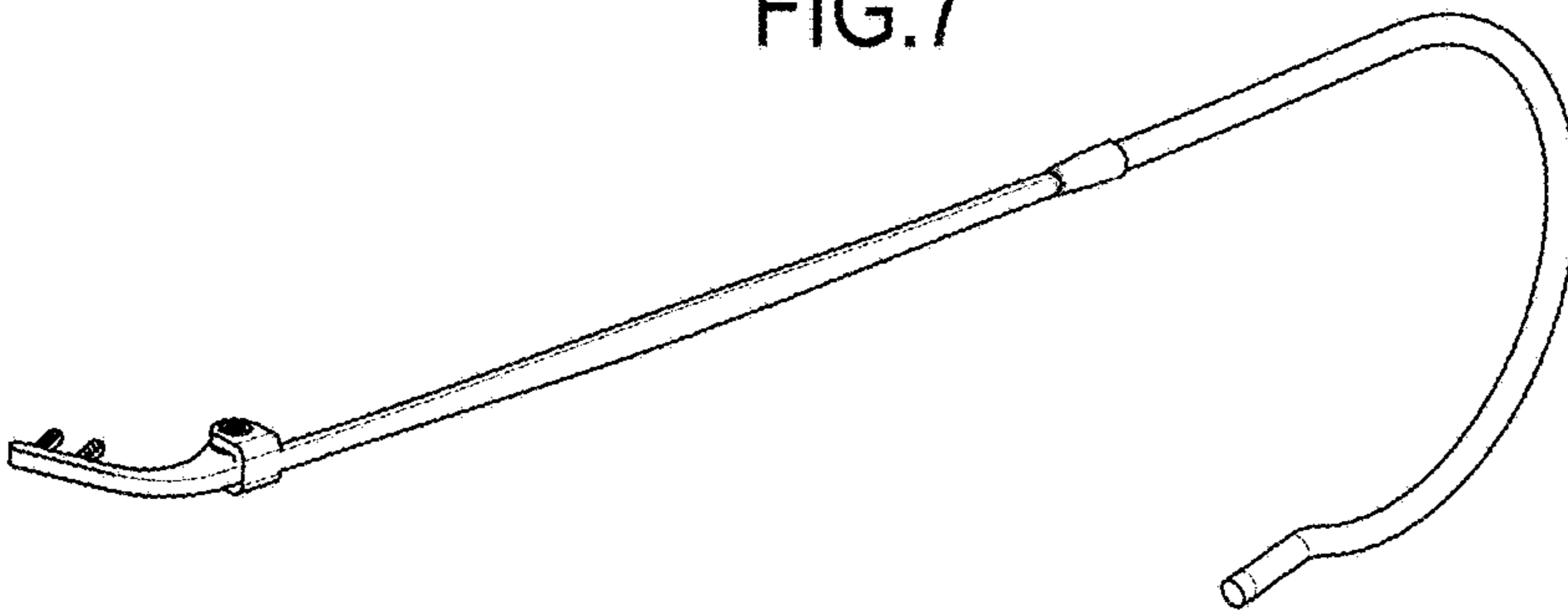

FIG.8

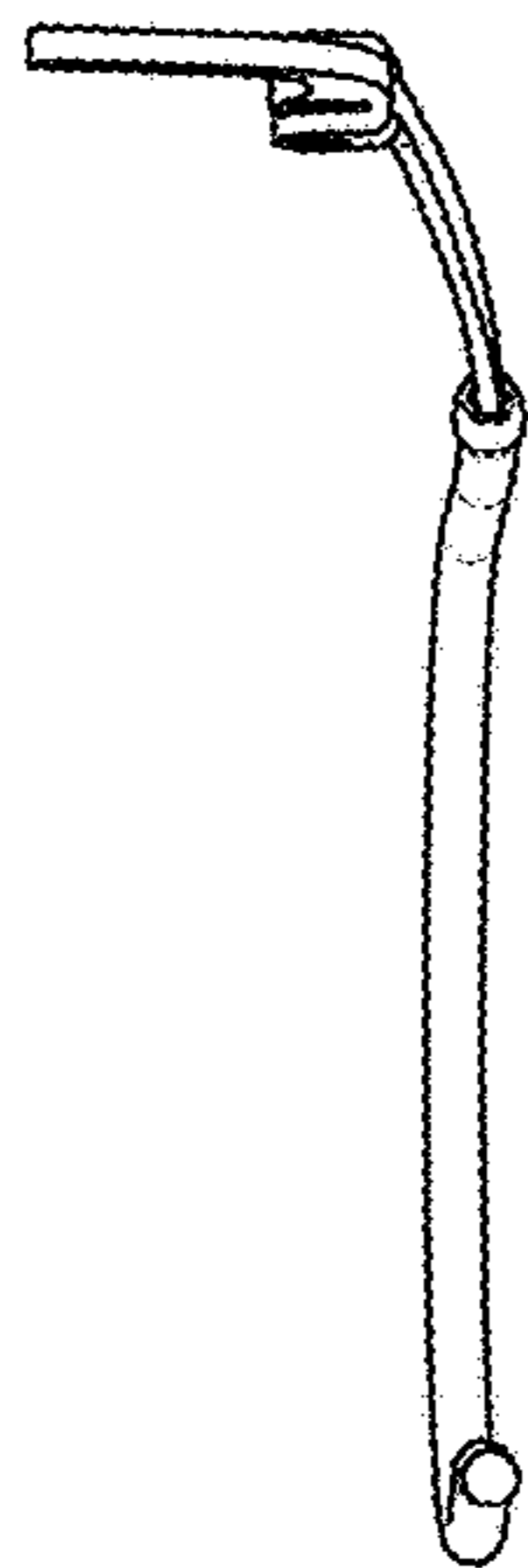

FIG.9

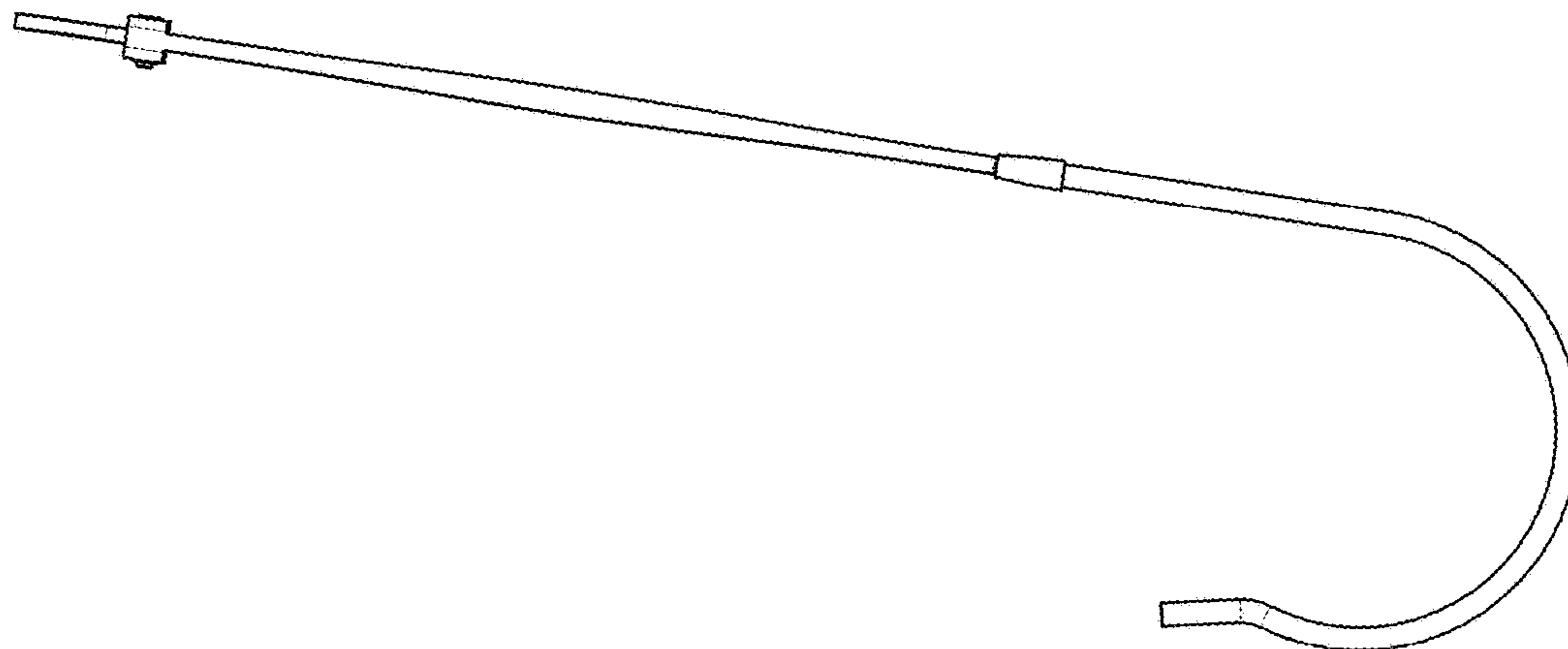

FIG.10

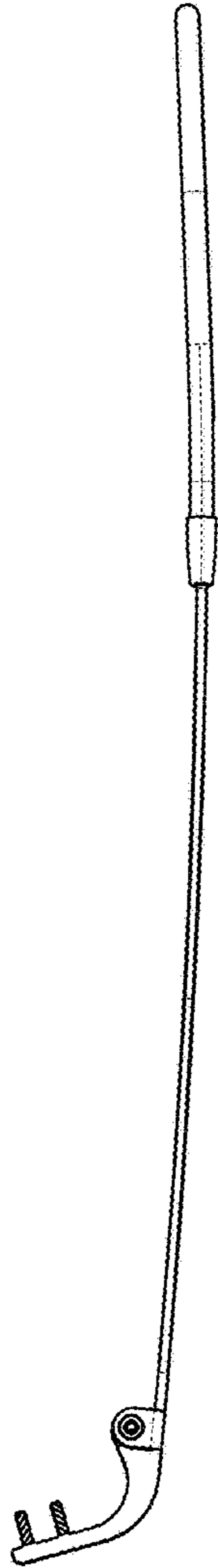

FIG.11

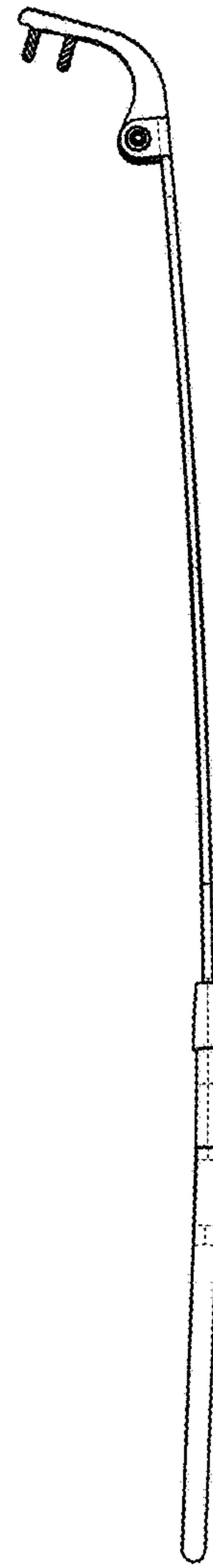

FIG.12

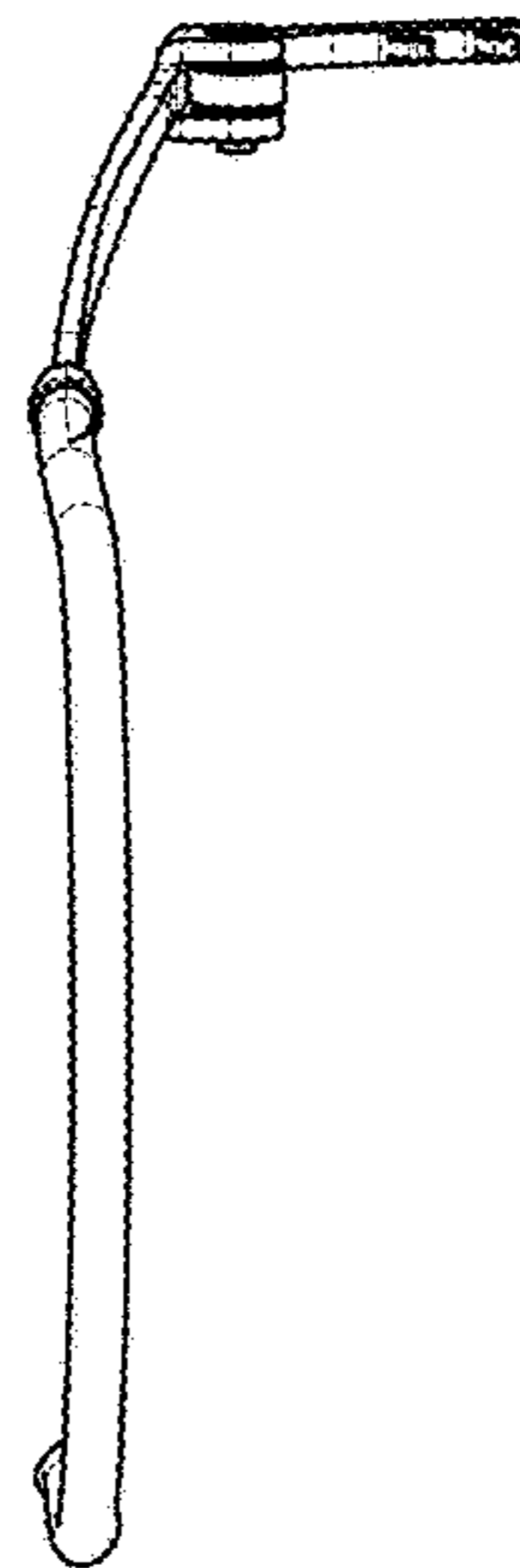

FIG.13

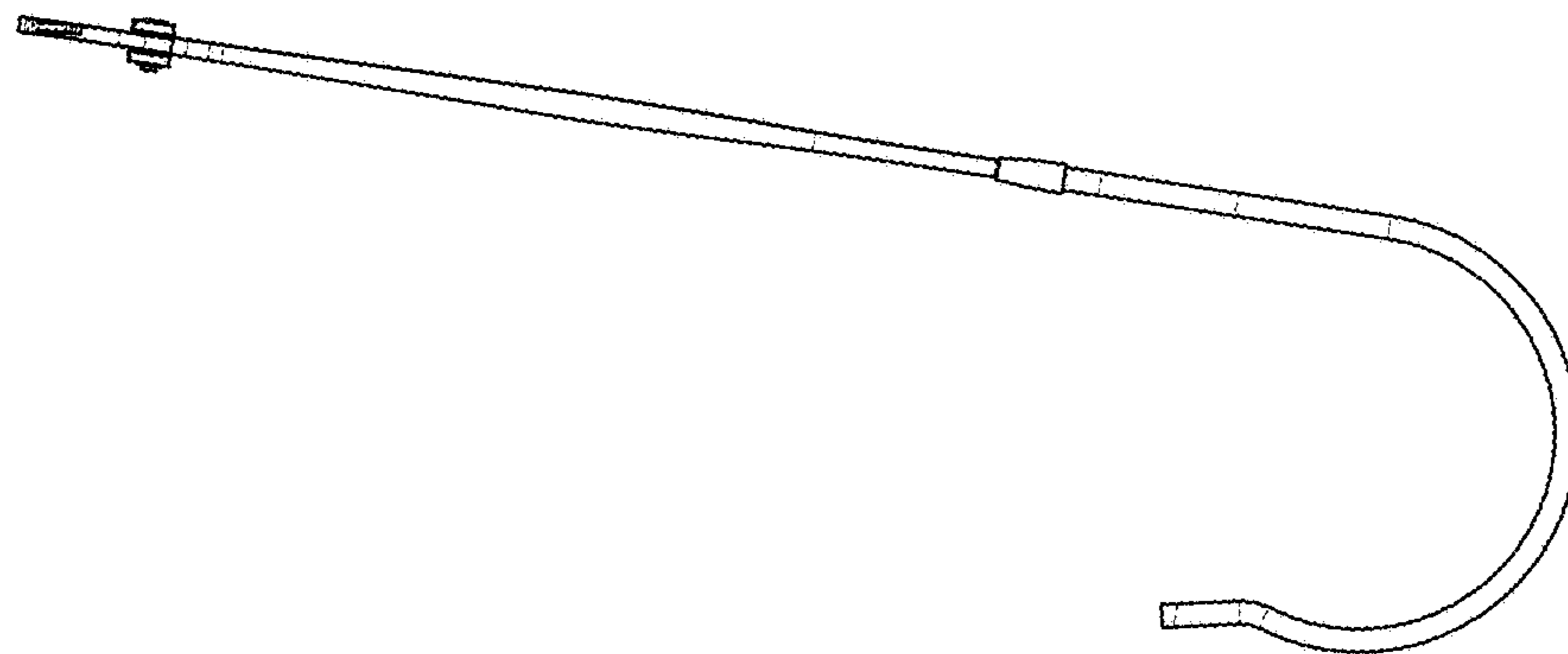

FIG. 14

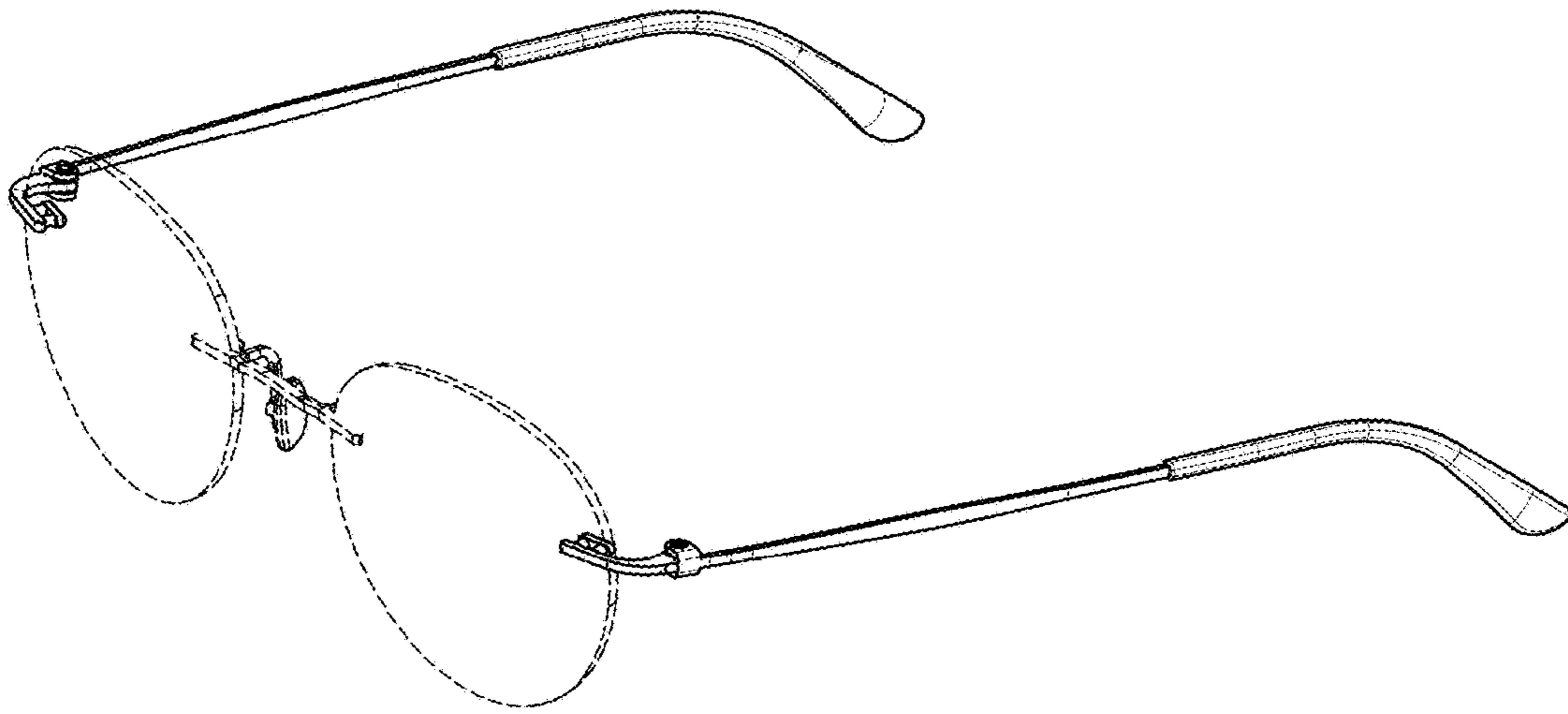

FIG. 15

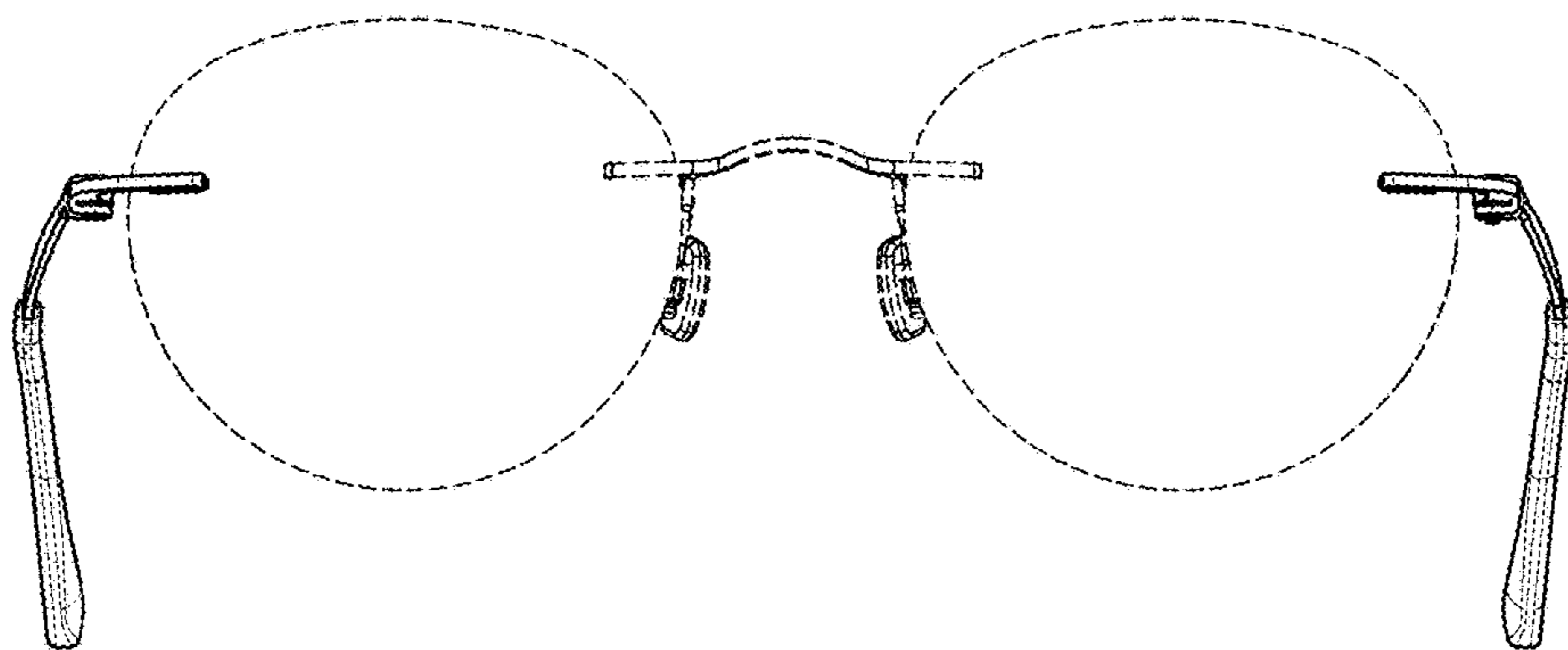



FIG. 16

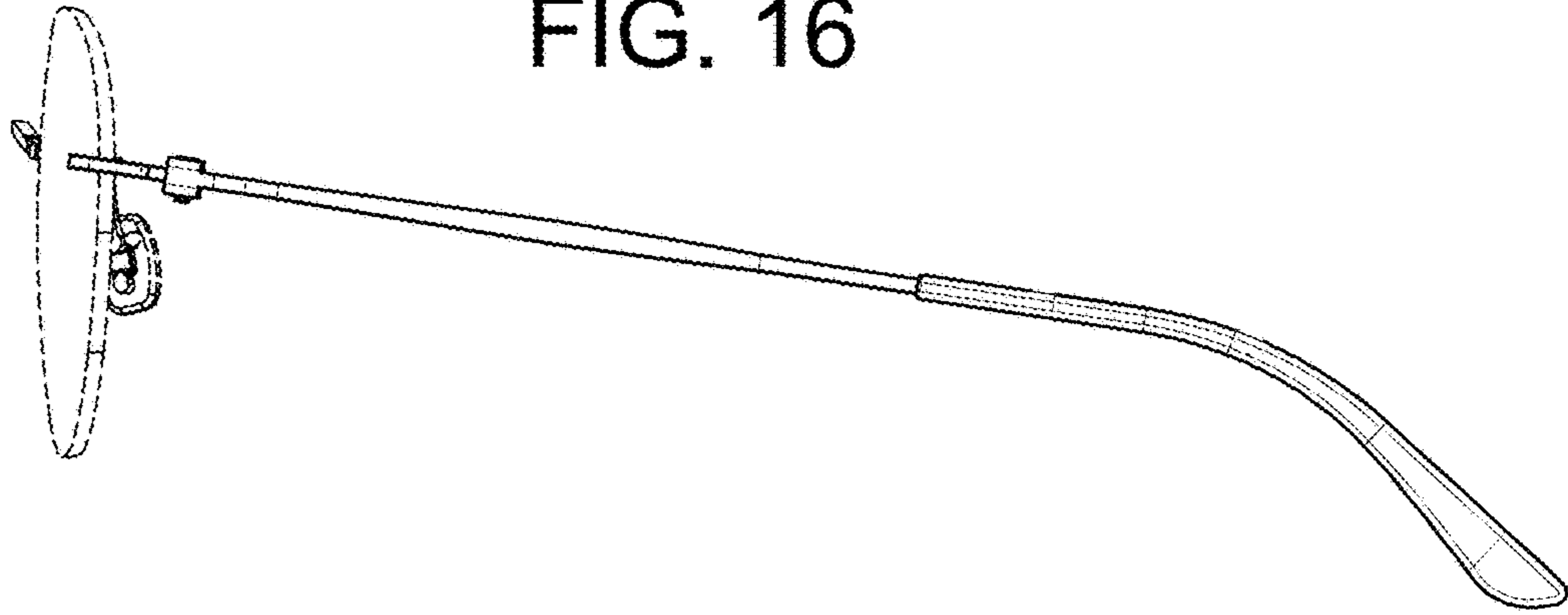

FIG. 17

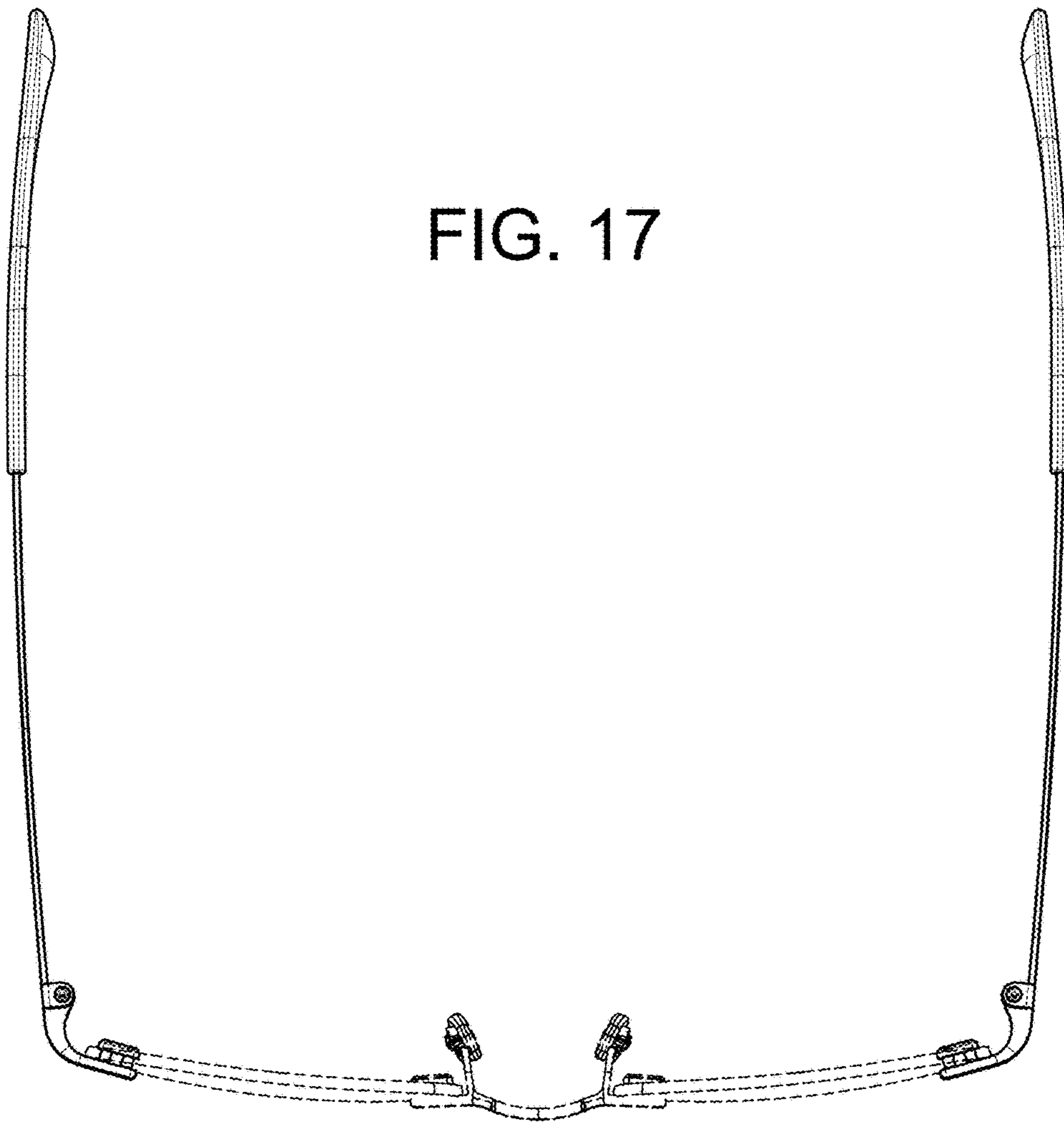

FIG. 18



FIG. 19

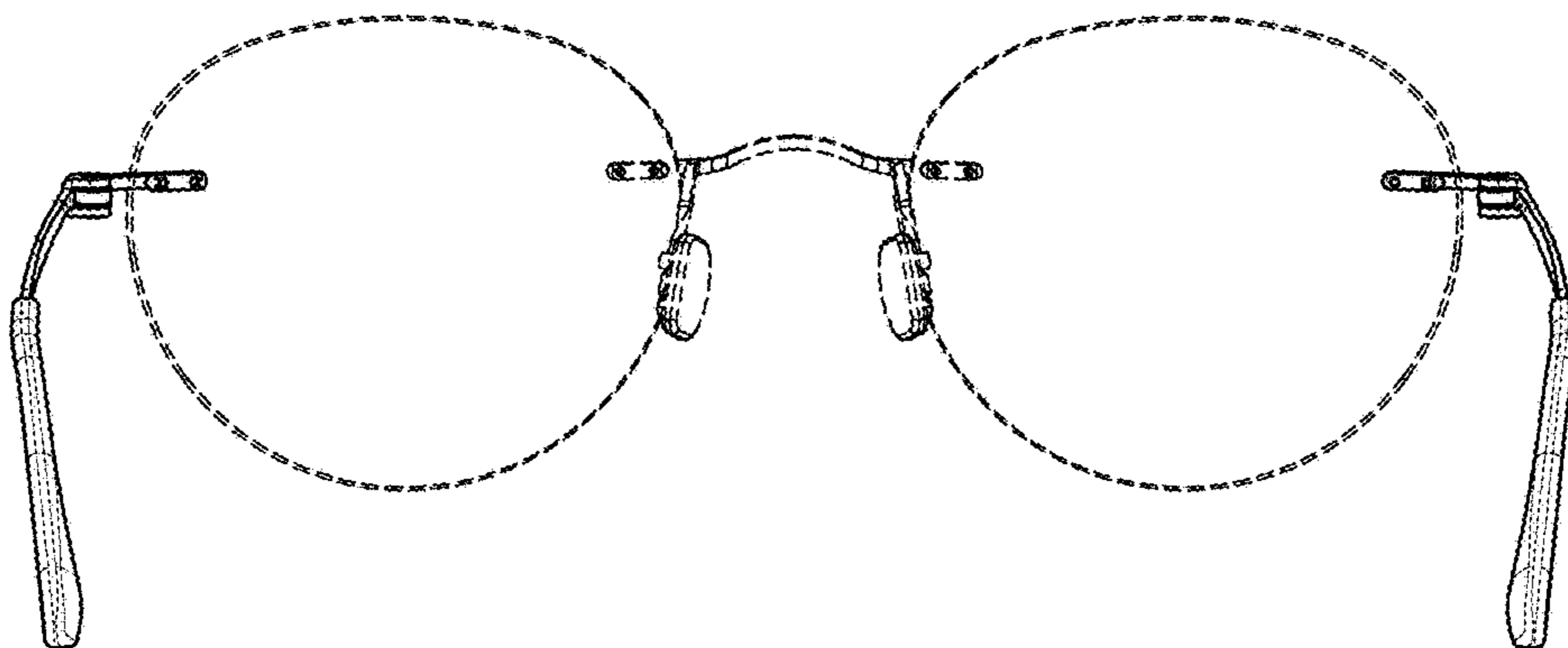

FIG. 20

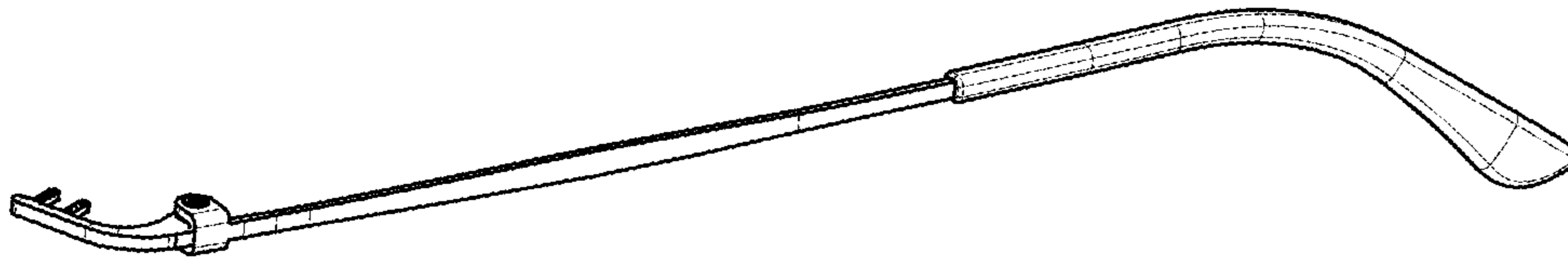

FIG. 21

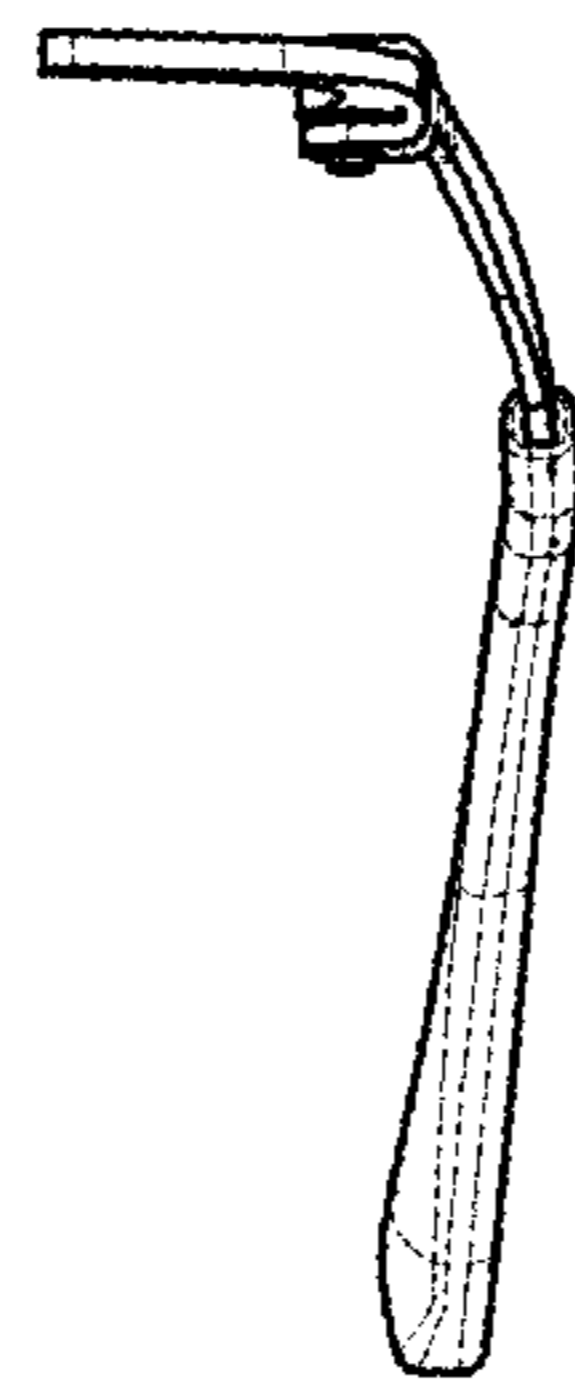

FIG. 22

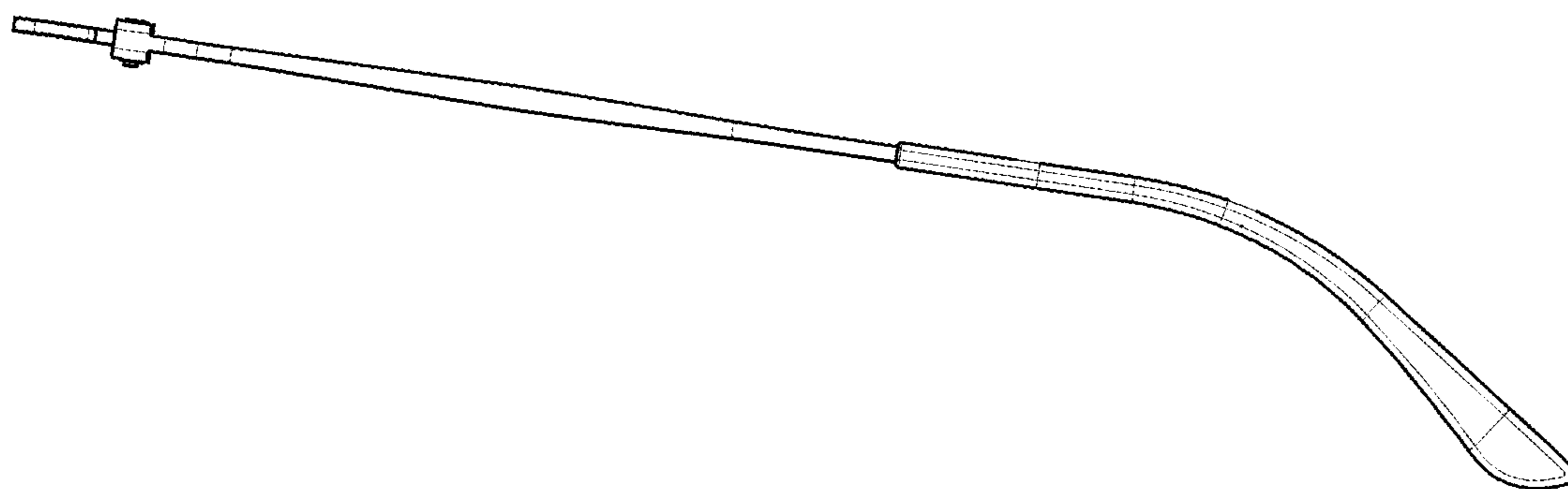

FIG. 23

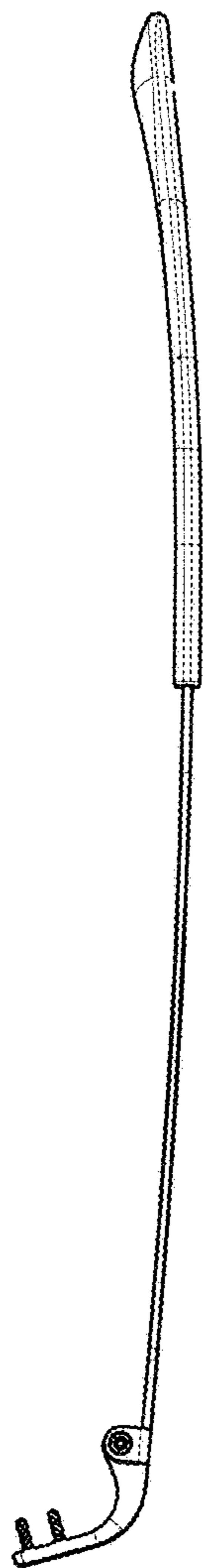

FIG. 24

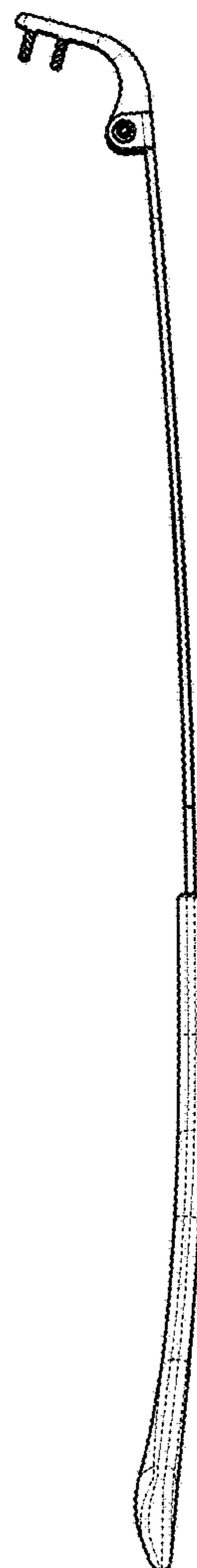

FIG. 25

