



US00D778907S

(12) **United States Design Patent**  
**Maeda et al.**

(10) **Patent No.:** **US D778,907 S**

(45) **Date of Patent:** **\*\* Feb. 14, 2017**

(54) **IMAGE DISPLAY DEVICE**

(71) Applicant: **BROTHER INDUSTRIES, LTD.**,  
Nagoya-shi, Aichi-ken (JP)

(72) Inventors: **Shino Maeda**, Nagoya (JP); **Yosuke Mase**, Nagoya (JP)

(73) Assignee: **BROTHER INDUSTRIES, LTD.**,  
Nagoya-shi (JP)

(\*\*) Term: **15 Years**

(21) Appl. No.: **29/537,593**

(22) Filed: **Aug. 27, 2015**

(30) **Foreign Application Priority Data**

Mar. 27, 2015 (JP) ..... 2015-6599

(51) **LOC (10) Cl.** ..... **14-02**

(52) **U.S. Cl.**  
USPC ..... **D14/372**

(58) **Field of Classification Search**  
USPC ..... D14/372, 496, 432, 371, 125, 126, 129,  
D14/299; D16/300-342; 351/158, 153,  
351/144; 345/7-9, 905; 455/344; 348/115,  
348/53, 121, 739

CPC ..... G02B 27/017; G02B 27/0158; G02B  
27/0161; G02B 27/0181; G02B 27/0185;  
G02B 27/0189

See application file for complete search history.

(56) **References Cited**

**U.S. PATENT DOCUMENTS**

D692,424 S \* 10/2013 Pombo ..... D14/372  
D702,234 S \* 4/2014 Pombo ..... D14/372  
D713,406 S \* 9/2014 Pombo ..... D14/372

D714,786 S \* 10/2014 Pombo ..... D14/372  
D727,896 S \* 4/2015 Lалуque ..... D14/372  
D730,352 S \* 5/2015 Chow ..... D14/372  
D737,821 S \* 9/2015 Cho ..... D14/205  
D740,284 S \* 10/2015 Maeda ..... D14/372  
D751,073 S \* 3/2016 Nagao ..... D14/372  
D760,225 S \* 6/2016 Passmore ..... D14/372  
D762,212 S \* 7/2016 Iritani ..... D14/372  
D764,467 S \* 8/2016 Nokuo ..... D14/372  
2013/0285886 A1 \* 10/2013 Pombo ..... G02B 27/0149  
345/8

**OTHER PUBLICATIONS**

U.S. Appl. No. 29/519,365, filed Mar. 4, 2015.

\* cited by examiner

*Primary Examiner* — Austin Murphy

(74) *Attorney, Agent, or Firm* — Oliff PLC

(57) **CLAIM**

The ornamental design for an image display device, as shown and described.

**DESCRIPTION**

FIG. 1 is a top, front, right-side perspective view of an image display device;

FIG. 2 is a bottom, rear, left-side perspective view thereof;

FIG. 3 is a front view thereof;

FIG. 4 is a top view thereof;

FIG. 5 is a right-side view thereof;

FIG. 6 is a left-side view thereof;

FIG. 7 is a rear view thereof; and,

FIG. 8 is a bottom view thereof.

The broken lines depict environmental subject matter only and form no part of the claimed design.

**1 Claim, 6 Drawing Sheets**

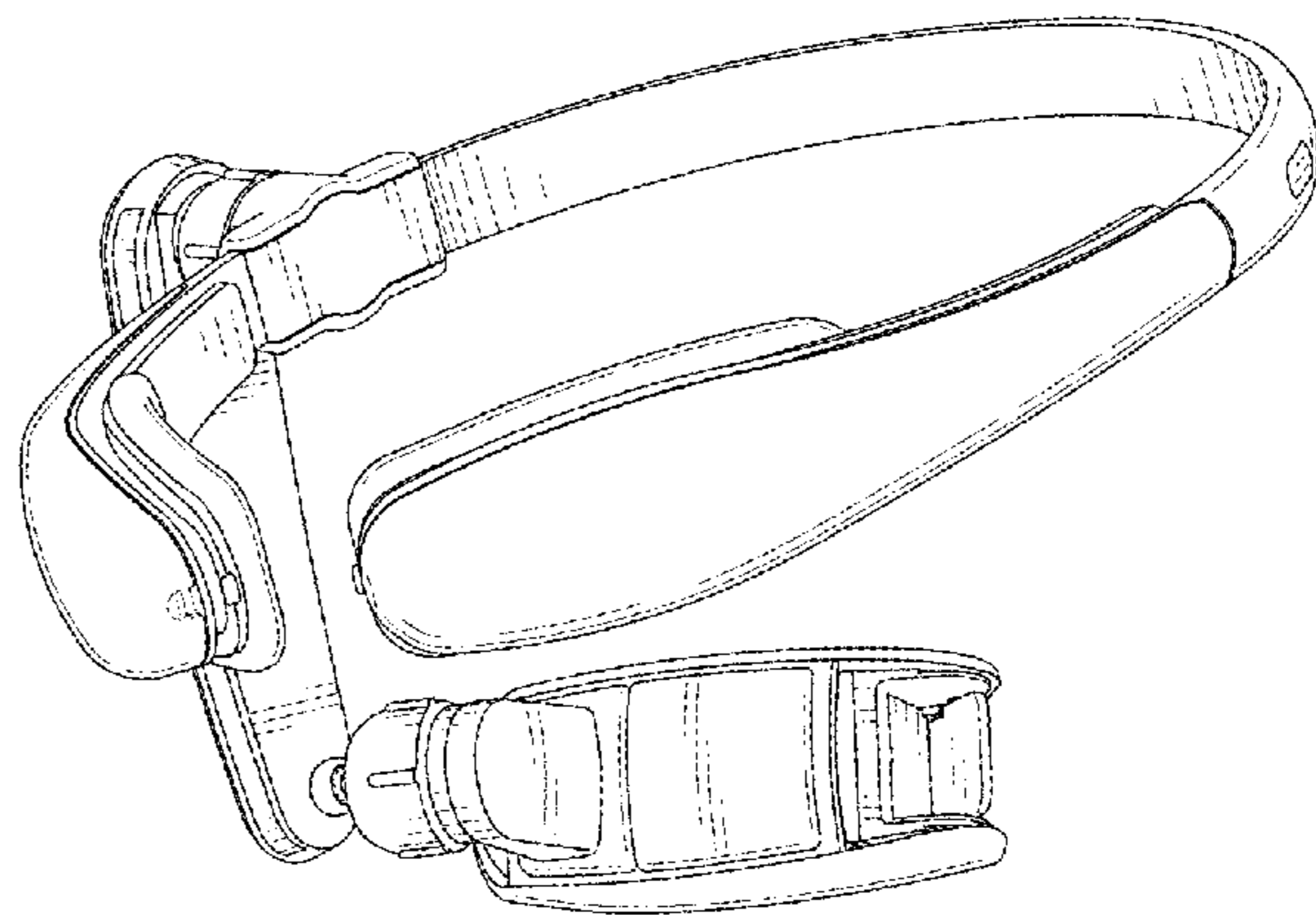
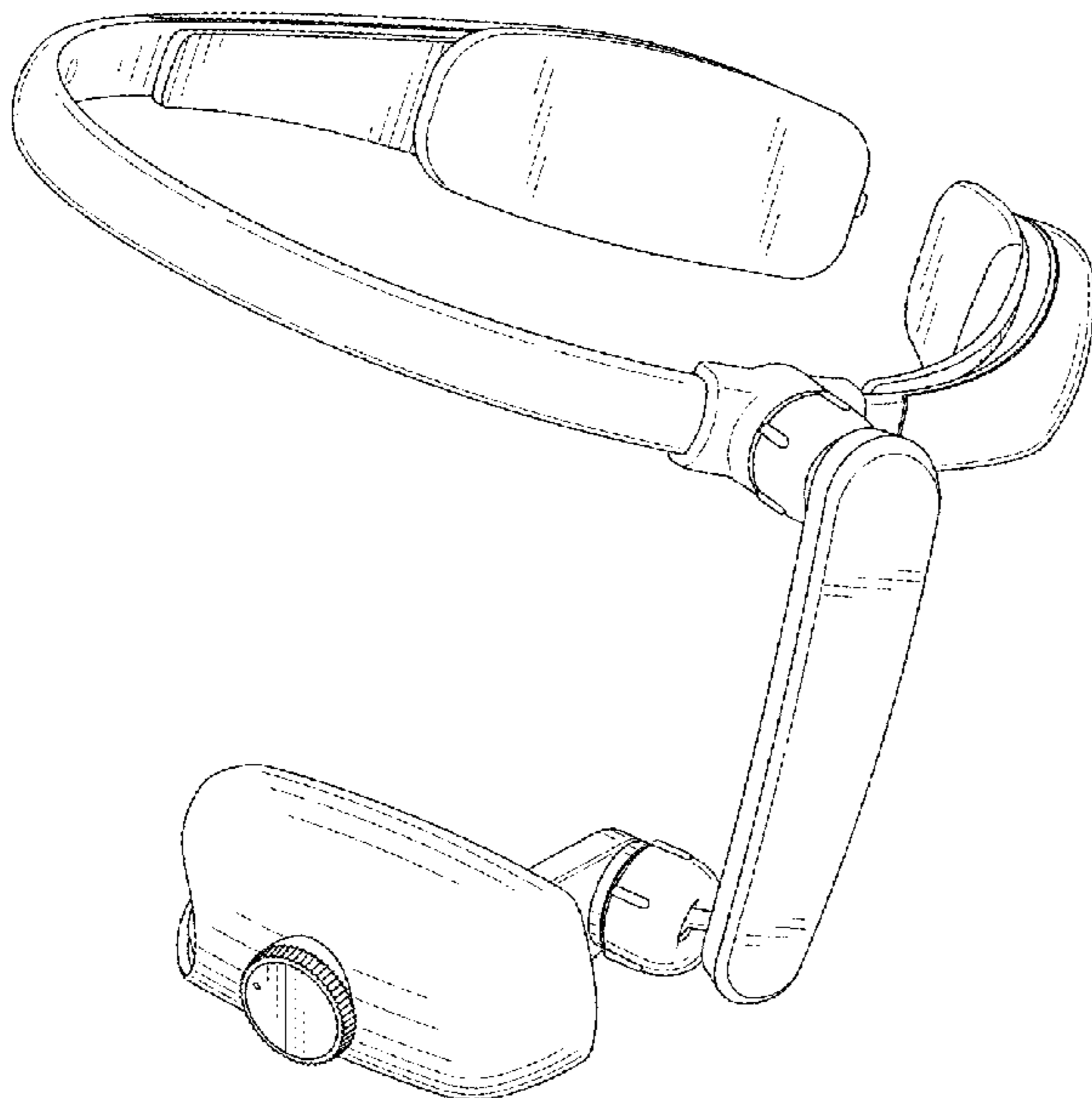

FIG. 1

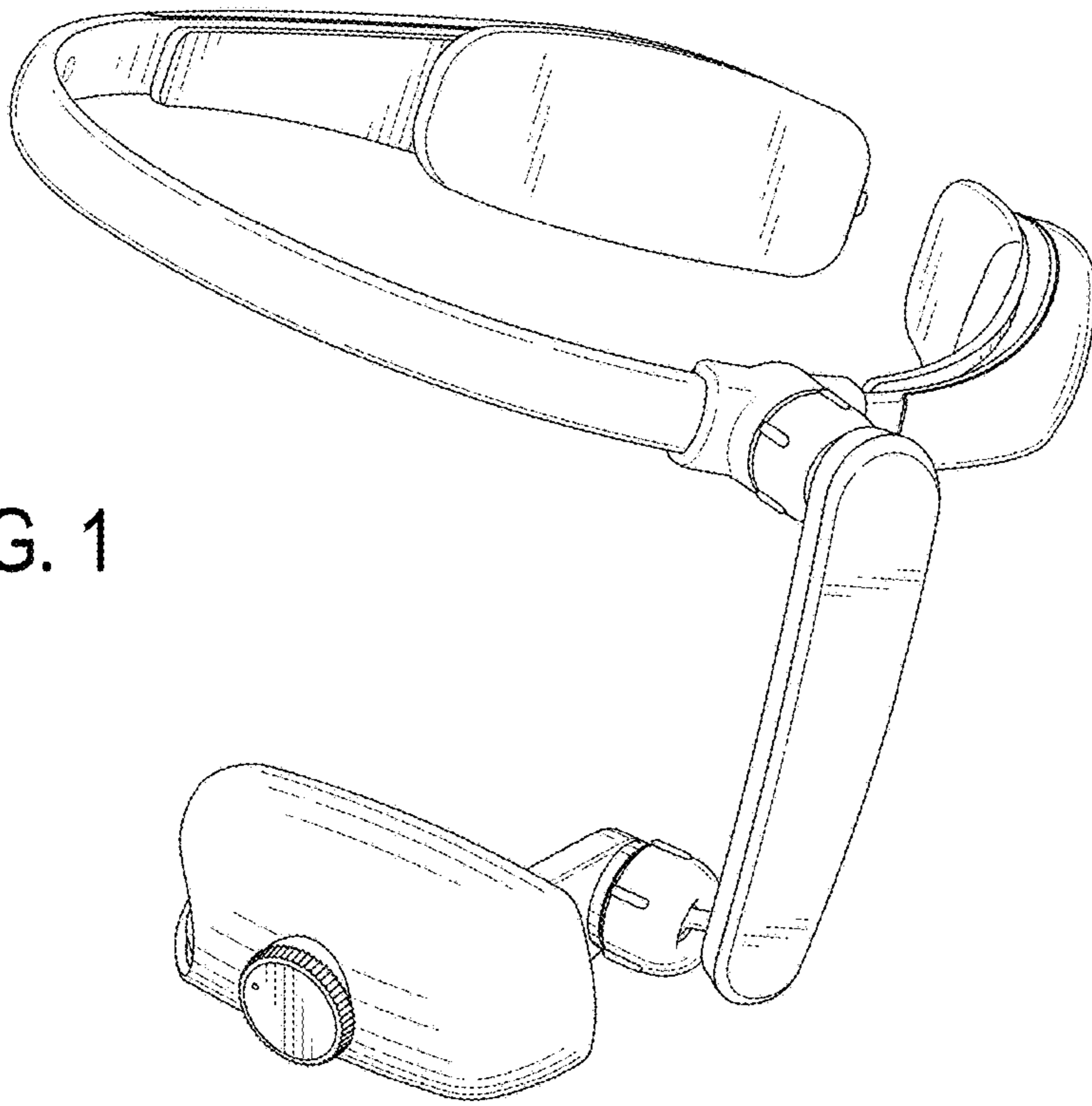
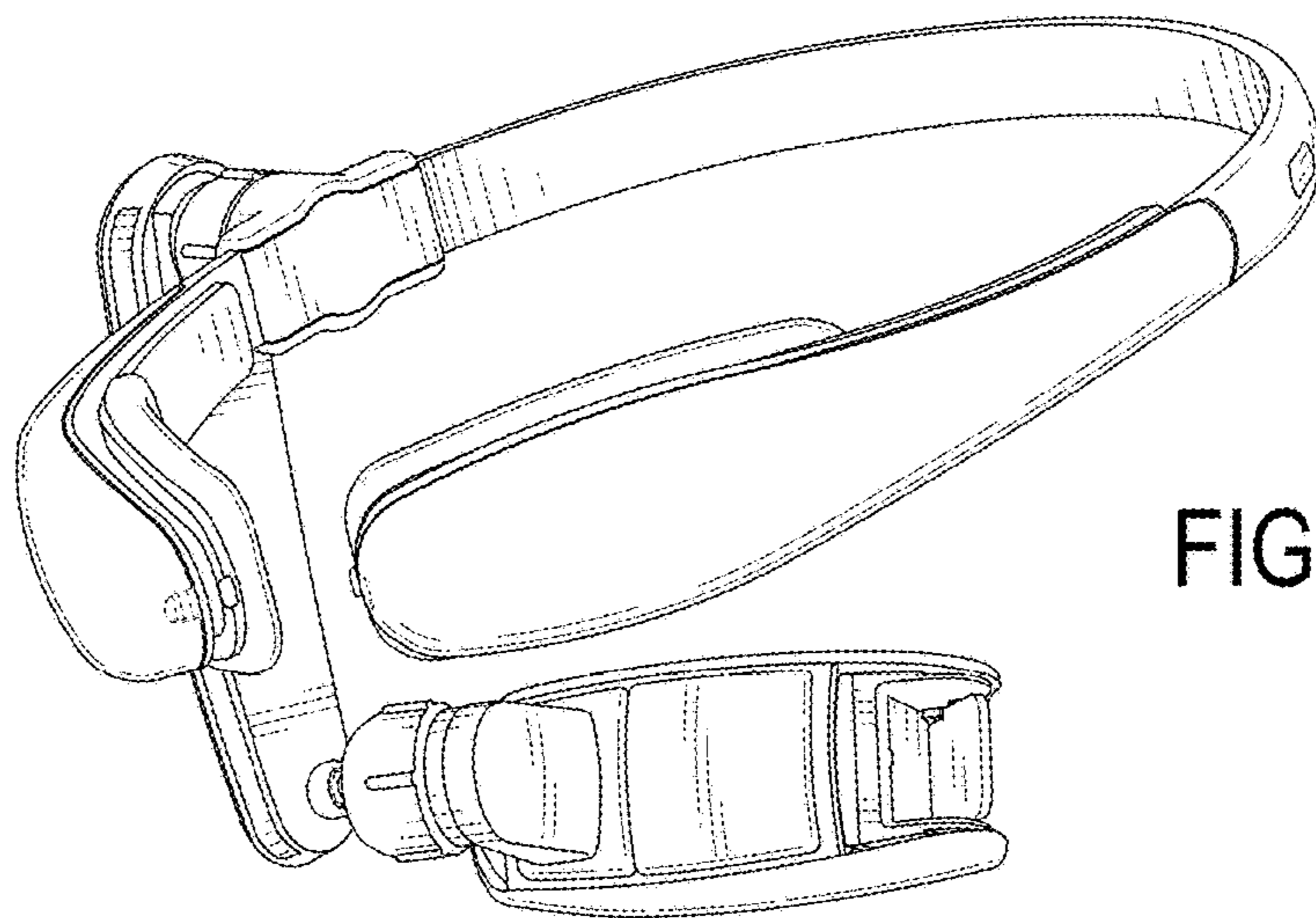

FIG. 2



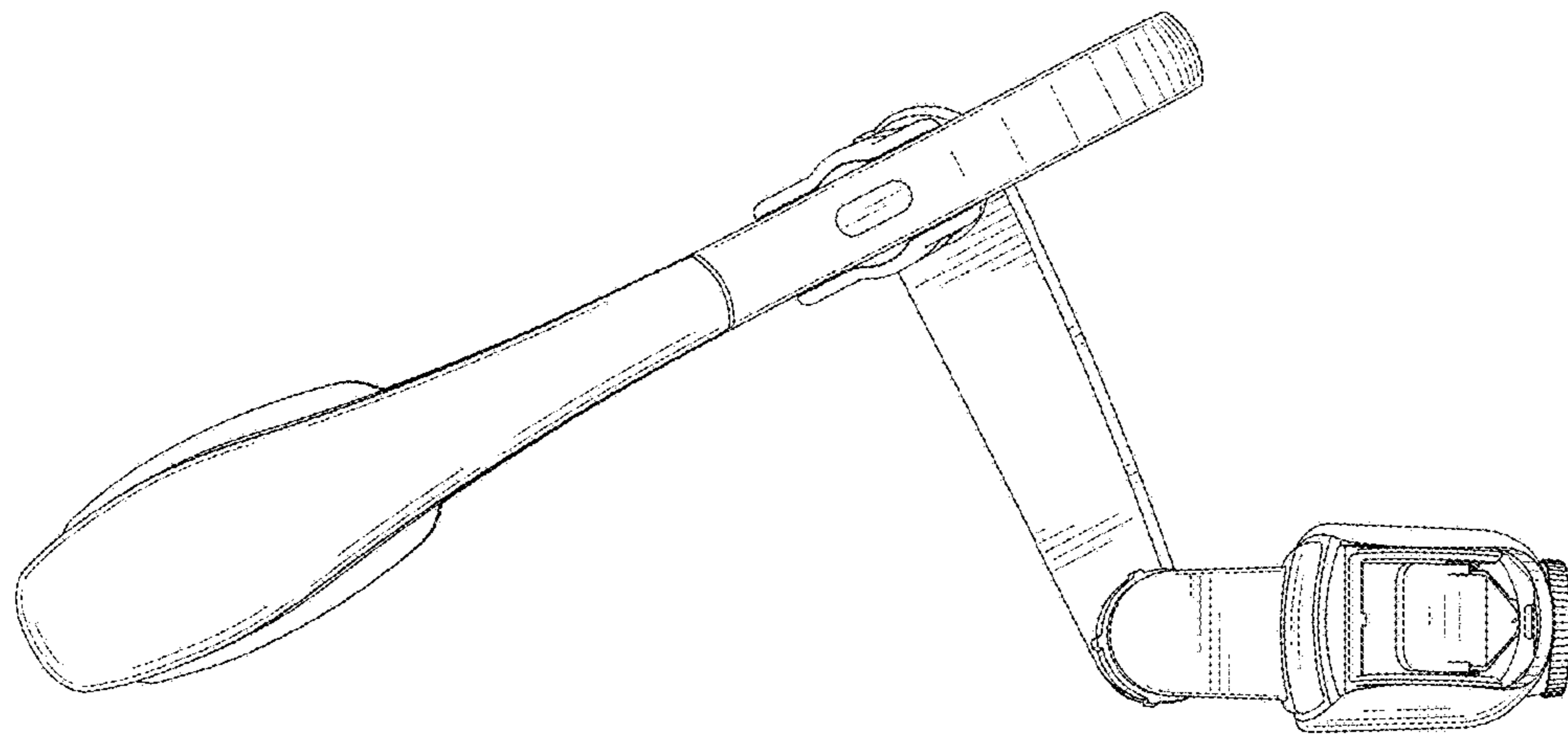

FIG. 3

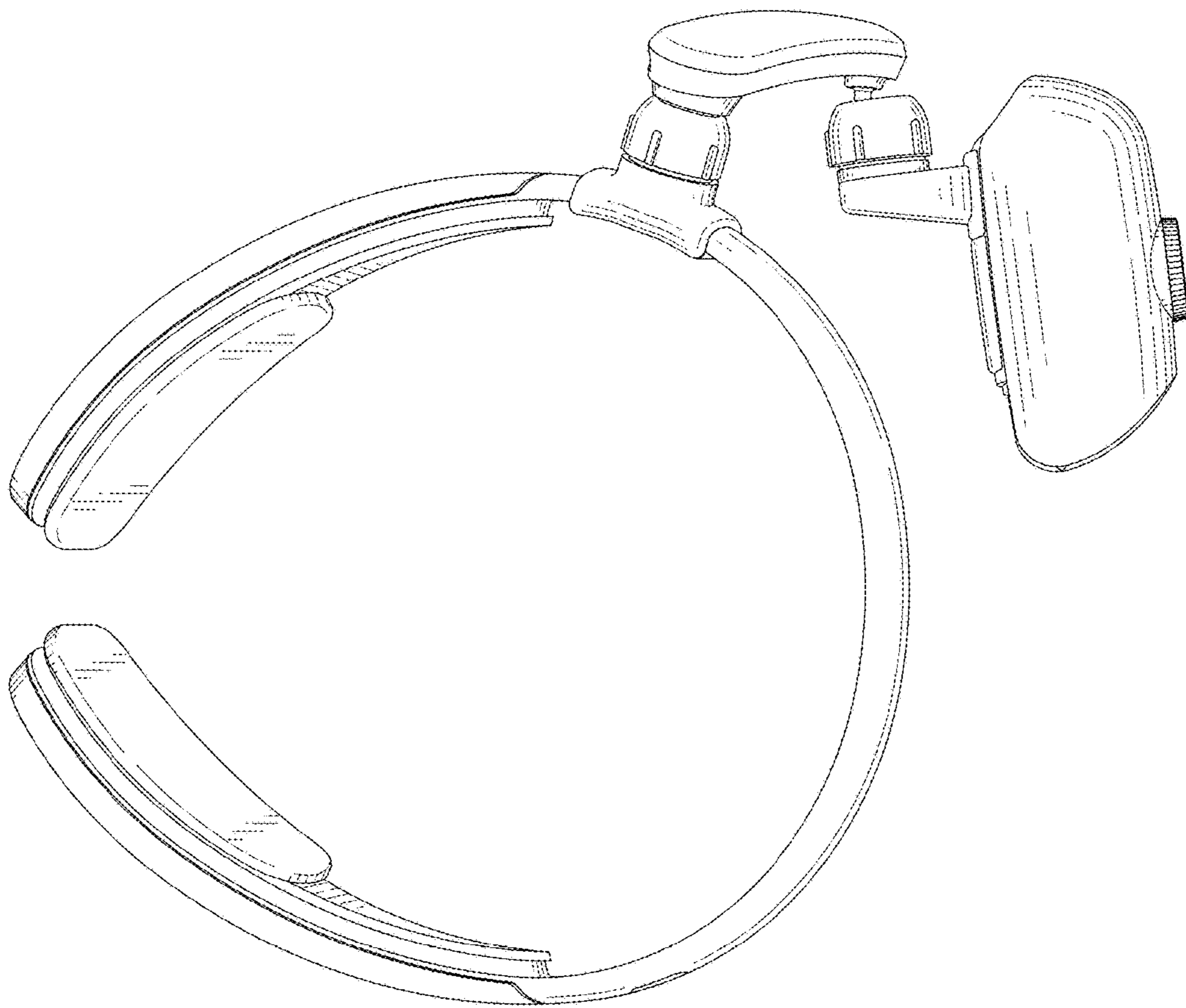

FIG. 4



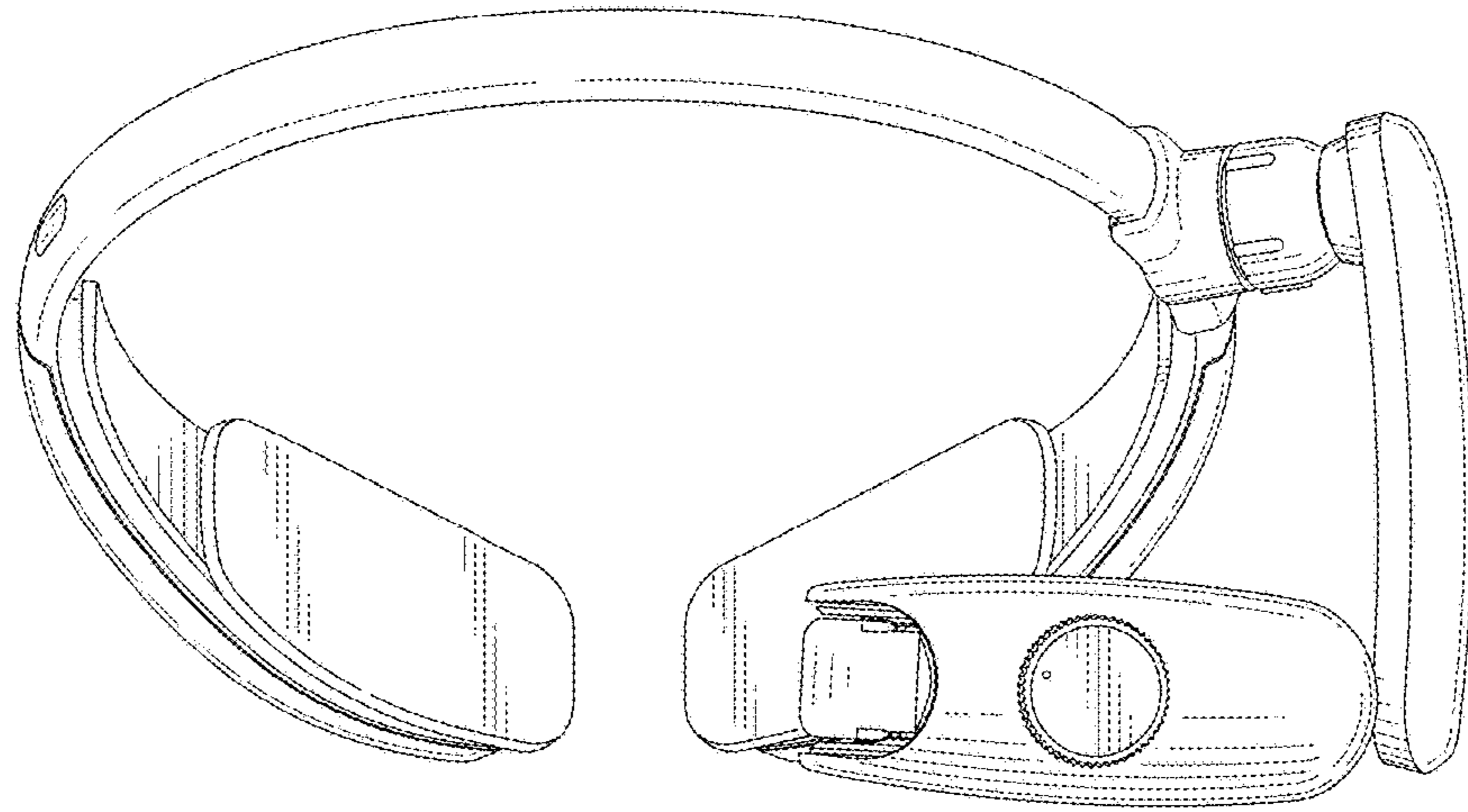

FIG. 5

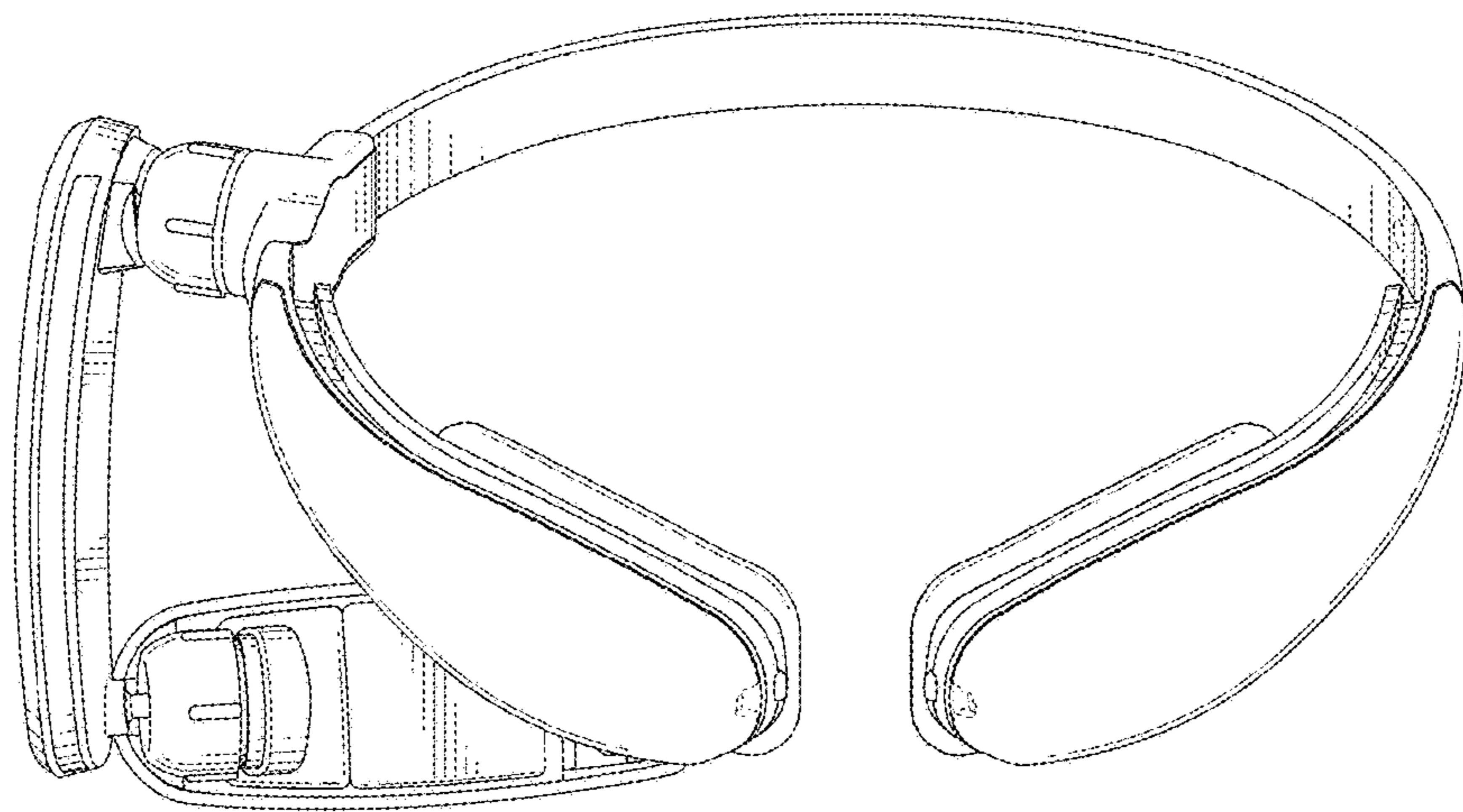

FIG. 6

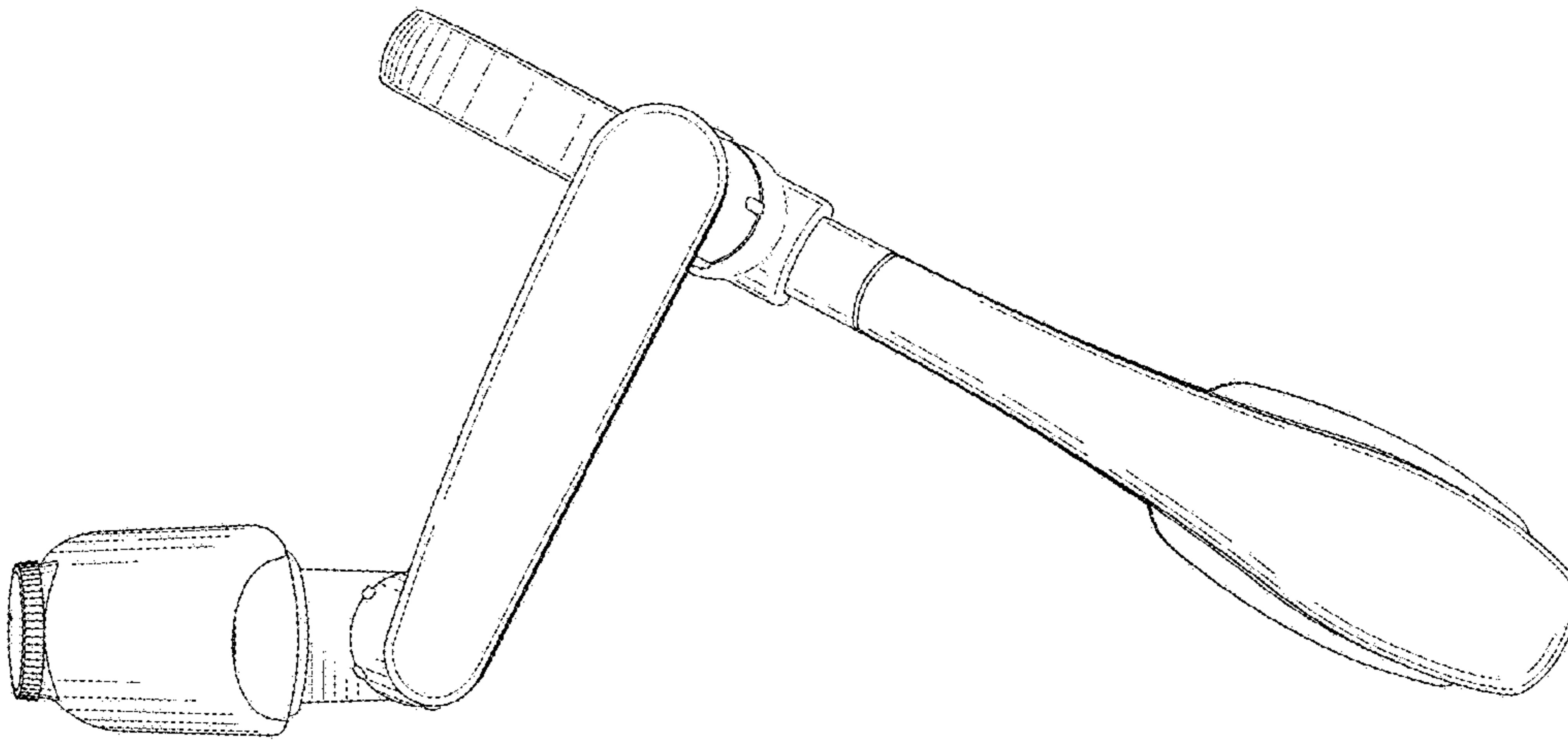

FIG. 7

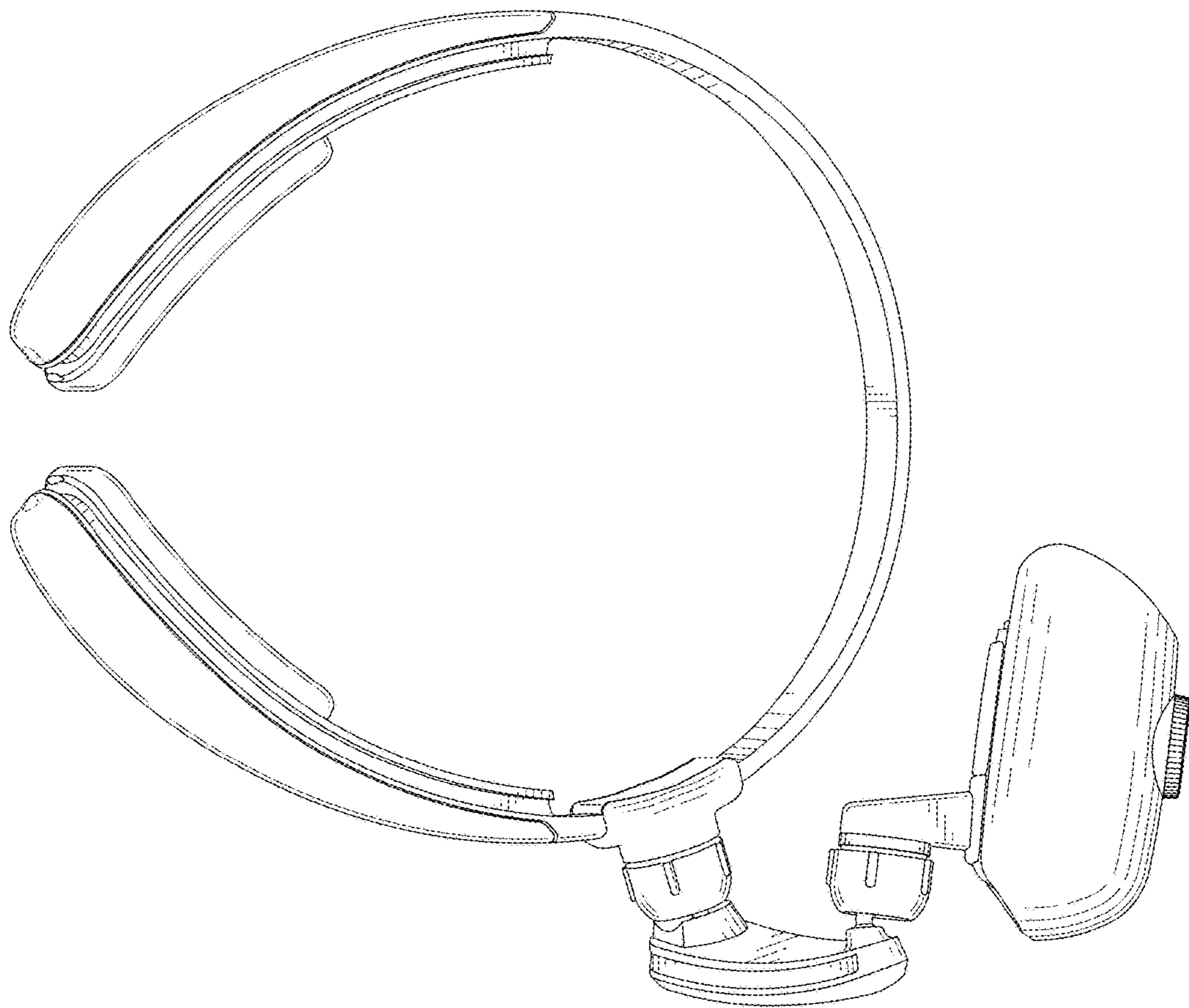

FIG. 8