



US00D778719S

(12) **United States Design Patent** (10) **Patent No.:** **US D778,719 S**
Sanfilippo et al. (45) **Date of Patent:** **** Feb. 14, 2017**

(54) **PACKAGE**
(71) Applicant: **CLEAR LAM PACKAGING, INC.**,
Elk Grove Village, IL (US)
(72) Inventors: **James J. Sanfilippo**, Barrington Hills,
IL (US); **Milorad Radenovic**, Chicago,
IL (US)
(73) Assignee: **CLEAR LAM PACKAGING, INC.**,
Elk Grove Village, IL (US)

2,508,962 A 5/1950 Moore
2,524,766 A 10/1950 Carroll
2,619,226 A 11/1952 Adams
2,750,093 A 6/1956 Moore
2,758,775 A 8/1956 Moore
(Continued)

FOREIGN PATENT DOCUMENTS

EP 1106508 A1 6/2001
EP 1508531 A1 2/2005
(Continued)

(**) Term: **14 Years**

OTHER PUBLICATIONS

(21) Appl. No.: **29/506,380**

Reynolds, "Doritos Gamer Packs function on multiple levels",
Packaging World (Nov. 14, 2013).

(22) Filed: **Oct. 15, 2014**

(Continued)

(51) **LOC (10) Cl.** **09-03**

(52) **U.S. Cl.**
USPC **D9/432**

(58) **Field of Classification Search**
USPC D9/414-418, 420-427, 430-434;
D3/272, 273, 276, 281, 282, 302,
D3/304-309, 315; D7/601, 602
CPC B65D 5/00-5/02; B65D 5/0209-5/0272;
B65D 5/029; B65D 5/40; B65D
5/72; B65D 5/727; B65D
31/10-31/18; B65D 35/04; B65D 35/56
See application file for complete search history.

Primary Examiner — Vy Koenig
(74) *Attorney, Agent, or Firm* — Marshall, Gerstein &
Borun LLP

(57) **CLAIM**

The ornamental design for a package, as shown and
described.

DESCRIPTION

FIG. 1 is a front, right-side, and top view of a package that
has the design.
FIG. 2 is a top plan view of the package.
FIG. 3 is a front view of the package.
FIG. 4 is a rear view of the package.
FIG. 5 is a bottom view of the package.
FIG. 6 is a left-side view of the package. The right-side view
is a mirror image thereof; and,
FIG. 7 is a front, right side, and bottom view of the package.
The broken lines represent elements of the package that
form no part of the claimed design.

(56) **References Cited**

U.S. PATENT DOCUMENTS

2,017,176 A 10/1935 Andrews
2,041,227 A 5/1936 Chalmers
2,048,122 A 7/1936 Howard
2,092,858 A 9/1937 Richard
2,180,841 A 11/1939 Vogt
2,328,579 A 9/1943 Pelosi
2,339,156 A 1/1944 Duane
2,352,766 A 7/1944 Bogue
2,385,898 A 10/1945 Waters
2,416,332 A 2/1947 Lehman

1 Claim, 7 Drawing Sheets

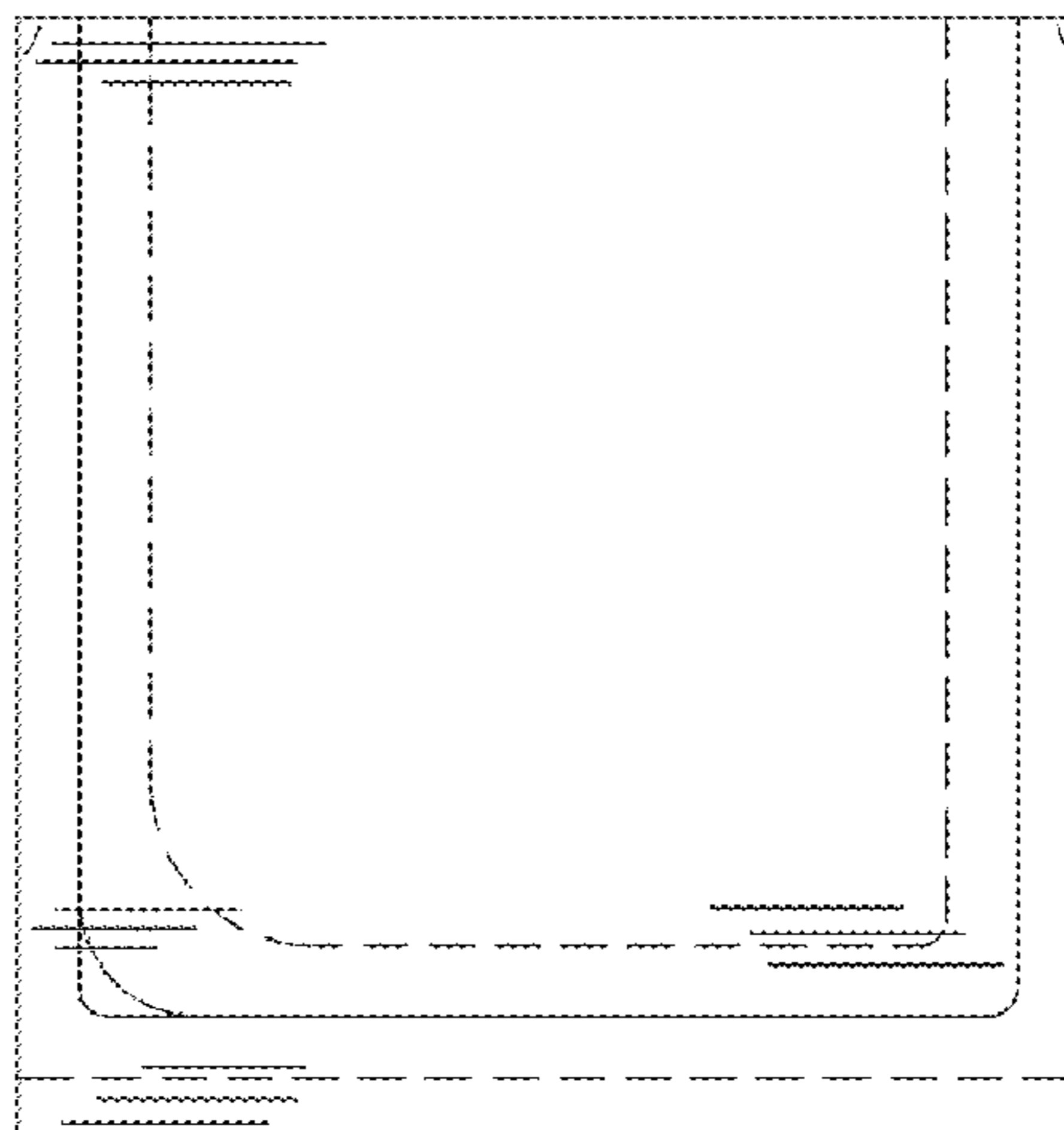

(56)

References Cited

U.S. PATENT DOCUMENTS

2,819,831 A	1/1958	Polarek et al.	5,556,026 A	9/1996	Blankitny
2,936,940 A	5/1960	Berghgracht	D374,774 S	10/1996	Cassel
2,970,735 A	2/1961	Jacke	5,577,612 A	11/1996	Chesson et al.
3,006,257 A	10/1961	Orsini	5,611,452 A	3/1997	Bonora et al.
3,127,082 A	3/1964	Meyer-Jagenberg	5,613,608 A	3/1997	Tronchetti et al.
3,154,215 A	10/1964	Le Vesconte	5,655,706 A	8/1997	Vandiver
3,228,584 A	1/1966	Ashton	D386,001 S	11/1997	Saffran
3,259,303 A	7/1966	Repko	5,704,480 A	1/1998	Scholz et al.
3,314,591 A	4/1967	Cheeley	D394,606 S	5/1998	Zorn et al.
3,344,974 A	10/1967	Bostrom	5,770,839 A	6/1998	Ruebush et al.
3,349,959 A	10/1967	Watkins	5,772,332 A	6/1998	Geller
3,373,917 A	3/1968	Cox	D395,952 S	7/1998	Buczynski et al.
3,380,646 A	4/1968	Doyen et al.	5,785,179 A	7/1998	Buczynski et al.
3,426,499 A	2/1969	Paige	5,788,121 A	8/1998	Sasaki et al.
3,434,652 A	3/1969	Shore	5,788,378 A	8/1998	Thomas
3,437,258 A	4/1969	Kugler	5,791,465 A	8/1998	Niki et al.
3,462,067 A	8/1969	Shore	D398,526 S	9/1998	Schwarz et al.
3,505,779 A	4/1970	Kopp	D398,844 S	9/1998	Oberloier
3,562,392 A	2/1971	Mylus	5,799,863 A	9/1998	Capy et al.
3,604,491 A	9/1971	Spiess	5,826,401 A	10/1998	Bois
3,737,095 A	6/1973	Derauf	5,842,790 A	12/1998	Imer
3,738,567 A	6/1973	Ruda	5,862,652 A	1/1999	Schoeler
3,739,977 A	6/1973	Shapiro et al.	D409,484 S	5/1999	Tasker
3,785,112 A	1/1974	Leasure et al.	D412,439 S	8/1999	Cormack
3,917,158 A	11/1975	Dorofachuk et al.	6,005,234 A	12/1999	Moseley et al.
3,935,993 A	2/1976	Doyen et al.	6,021,624 A	2/2000	Richison et al.
3,940,054 A	2/1976	Goebel et al.	6,026,953 A	2/2000	Nakamura et al.
3,968,921 A	7/1976	Jewell	D421,901 S	3/2000	Hill
3,980,225 A	9/1976	Kan	D421,902 S	3/2000	Hill
4,041,851 A	8/1977	Jentsch	6,036,365 A	3/2000	Imer
4,101,051 A	7/1978	Reil	D427,056 S	6/2000	Irace et al.
4,129,976 A	12/1978	Grundler et al.	6,113,271 A	9/2000	Scott et al.
4,197,949 A	4/1980	Carlsson	6,120,183 A	9/2000	Buchanan et al.
4,308,679 A	1/1982	Ray, III et al.	D431,464 S	10/2000	Collins et al.
D265,777 S	8/1982	Elzea et al.	6,137,098 A	10/2000	Moseley et al.
4,345,393 A	8/1982	Price et al.	6,149,304 A	11/2000	Hamilton et al.
D266,049 S	9/1982	Conti	D437,686 S	2/2001	Balzar et al.
4,351,473 A	9/1982	Manizza	D437,689 S	2/2001	Chen
4,353,497 A	10/1982	Bustin	6,182,887 B1	2/2001	Ljunstrom et al.
4,512,476 A	4/1985	Herrington, Jr.	6,229,061 B1	5/2001	Dragoo et al.
4,531,668 A	7/1985	Forbes, Jr.	6,231,237 B1	5/2001	Geller
4,576,309 A	3/1986	Tzifkansky et al.	6,261,215 B1	7/2001	Imer
D285,777 S	9/1986	Forbes, Jr.	D446,014 S	8/2001	Adkins
D286,745 S	11/1986	Forbes, Jr.	6,273,610 B1	8/2001	Koyama et al.
4,687,104 A	8/1987	Ielmini	6,274,181 B1	8/2001	Richison et al.
4,738,365 A	4/1988	Prater	D447,689 S	9/2001	Navet et al.
4,746,019 A	5/1988	Prater	D450,960 S	11/2001	Boyea et al.
D297,214 S	8/1988	Forbes, Jr.	D451,385 S	12/2001	Bryan et al.
4,790,436 A	12/1988	Nakamura	D452,374 S	12/2001	Kim
4,798,295 A	1/1989	Rausing	6,325,239 B2	12/2001	Randall et al.
4,837,849 A	6/1989	Erickson et al.	D454,495 S	3/2002	Bryan et al.
4,848,575 A	7/1989	Nakamura et al.	D459,652 S	7/2002	Beutler
4,851,246 A	7/1989	Maxwell et al.	6,423,356 B2	7/2002	Richison et al.
D304,016 S	10/1989	Forbes, Jr.	D461,403 S	8/2002	Chomik et al.
D315,099 S	3/1991	Alizard	D461,404 S	8/2002	Steiger
D316,037 S	4/1991	Kea	D463,276 S	9/2002	Piscopo et al.
5,036,997 A	8/1991	May et al.	6,446,796 B1	9/2002	Schmidt
5,044,777 A	9/1991	Watkins et al.	D464,566 S	10/2002	Anchor et al.
5,059,036 A	10/1991	Richison et al.	D464,884 S	10/2002	Sumpmann et al.
5,065,887 A	11/1991	Schuh et al.	D464,894 S	10/2002	Mittersinker et al.
5,158,371 A	10/1992	Moravek	6,481,183 B1	11/2002	Schmidt
D332,399 S	1/1993	Neff	D466,807 S	12/2002	Buck et al.
D333,781 S	3/1993	Kobel	6,488,175 B2	12/2002	Shiffler et al.
5,195,829 A	3/1993	Watkins et al.	6,510,673 B1	1/2003	Visona' et al.
5,205,651 A	4/1993	Decottignies et al.	6,513,308 B1	2/2003	Meeuwesen et al.
5,254,073 A	10/1993	Richison et al.	D471,804 S	3/2003	Staples
D351,090 S	10/1994	Narsutis	D473,461 S	4/2003	Joubert
5,353,946 A	10/1994	Behrend	6,615,567 B2	9/2003	Kuhn et al.
5,356,069 A	10/1994	Bochet et al.	6,659,645 B1	12/2003	Schulz
5,366,104 A	11/1994	Armstrong	D485,461 S	1/2004	Sams et al.
D354,436 S	1/1995	Krupa	6,679,034 B2	1/2004	Kohl et al.
D364,563 S	11/1995	Miller et al.	D486,731 S	2/2004	Meeker et al.
5,498,080 A	3/1996	Dalea et al.	6,695,757 B2	2/2004	Edwards et al.
5,505,305 A	4/1996	Scholz et al.	D487,192 S	3/2004	Farnham et al.
5,542,902 A	8/1996	Richison et al.	D489,530 S	5/2004	Lindsay
			6,729,112 B2	5/2004	Kuss et al.
			6,736,309 B1	5/2004	Westerman et al.
			6,746,388 B2	6/2004	Edwards et al.
			6,761,279 B1	7/2004	Martin et al.

(56)

References Cited

U.S. PATENT DOCUMENTS

6,783,277 B2 8/2004 Edwards et al.
 6,817,160 B2 11/2004 Schmidt
 D501,134 S 1/2005 Takahashi et al.
 6,845,602 B2 1/2005 Drut
 D502,095 S 2/2005 Tucker et al.
 D503,336 S 3/2005 Tucker et al.
 D504,622 S 5/2005 Takahashi et al.
 6,918,532 B2 7/2005 Sierra-Gomez et al.
 D510,263 S 10/2005 Isono et al.
 6,953,069 B2 10/2005 Galomb
 D513,870 S 1/2006 Rosine et al.
 D514,439 S 2/2006 Snedden et al.
 D528,010 S 9/2006 Yashima et al.
 D531,894 S 11/2006 Ramirez et al.
 D532,685 S * 11/2006 Reussner D9/416
 7,153,026 B2 12/2006 Galomb
 D535,187 S 1/2007 Clark et al.
 7,156,556 B2 1/2007 Takahashi et al.
 D536,608 S 2/2007 Arkins
 D539,134 S 3/2007 Wallach
 D540,187 S 4/2007 Duffy
 7,213,710 B2 5/2007 Cotert
 D544,762 S 6/2007 Zimmerman
 D545,186 S 6/2007 Liebe et al.
 D548,080 S 8/2007 Brown et al.
 D551,508 S 9/2007 Friedland et al.
 D552,468 S 10/2007 Seum et al.
 D552,470 S 10/2007 Kawaguchi et al.
 7,299,608 B2 11/2007 Kohl et al.
 D563,219 S 3/2008 Okin et al.
 7,350,688 B2 * 4/2008 Sierra-Gomez B65D 75/5838
 206/459.1
 D568,763 S 5/2008 Keberlein
 D569,719 S 5/2008 Ross
 D571,146 S 6/2008 Sanfilippo et al.
 D571,197 S 6/2008 Sanfilippo et al.
 D591,555 S 5/2009 Sanfilippo et al.
 D593,369 S 6/2009 Green et al.
 D604,502 S 11/2009 Lee et al.
 D608,193 S 1/2010 Sanfilippo et al.
 7,665,629 B2 2/2010 Julius et al.
 7,665,895 B2 2/2010 Takita et al.
 7,780,006 B2 8/2010 Clark, Jr. et al.
 D629,296 S 12/2010 De Muynck
 7,870,994 B2 1/2011 Spivey, Sr. et al.
 D637,577 S 5/2011 Han et al.
 D639,679 S 6/2011 Kissner et al.
 7,993,256 B2 8/2011 Takita et al.
 8,006,833 B2 8/2011 Clark, Jr. et al.
 8,038,349 B2 10/2011 Andersson et al.
 D648,302 S 11/2011 Park et al.
 8,066,137 B2 11/2011 Sanfilippo et al.
 8,132,395 B2 3/2012 Gehring et al.
 8,231,024 B2 7/2012 Sanfilippo et al.
 D667,733 S 9/2012 Beihoffer et al.
 D668,949 S 10/2012 Hipperson et al.
 8,276,353 B2 10/2012 Reaves et al.
 8,308,363 B2 11/2012 Vogt et al.
 D676,014 S 2/2013 Chung
 D682,244 S 5/2013 Park et al.
 D683,245 S 5/2013 Palmer et al.
 D684,853 S 6/2013 Dagnino
 D686,181 S 7/2013 Jeong
 D689,767 S 9/2013 Clark et al.
 D689,769 S 9/2013 Oates et al.

D696,107 S 12/2013 Kimple et al.
 8,602,242 B2 12/2013 Sanfilippo et al.
 8,602,244 B2 12/2013 Sanfilippo et al.
 D702,117 S 4/2014 Dagnino
 D703,036 S 4/2014 Baumwald et al.
 D706,629 S 6/2014 Bartels et al.
 D707,121 S 6/2014 Choi
 D710,215 S 8/2014 Palmer et al.
 D710,687 S 8/2014 Katopo et al.
 8,959,877 B2 * 2/2015 Maki B65D 5/542
 229/121
 D733,549 S * 7/2015 Sanfilippo D9/414
 D747,189 S * 1/2016 Sanfilippo D9/432
 D750,477 S * 3/2016 Sanfilippo D9/416
 D754,534 S * 4/2016 Sanfilippo D9/432
 2001/0005979 A1 7/2001 Kuss et al.
 2001/0040107 A1 11/2001 Toure et al.
 2002/0094922 A1 7/2002 Edwards et al.
 2003/0041564 A1 3/2003 Schmidt
 2003/0059130 A1 3/2003 Yoneyama et al.
 2003/0100424 A1 5/2003 Barmore et al.
 2003/0111523 A1 6/2003 Haugan
 2003/0230504 A1 12/2003 Hamming
 2004/0089578 A1 5/2004 Lin
 2004/0099570 A1 5/2004 Cargile
 2004/0185156 A1 9/2004 Garwood
 2004/0188457 A1 9/2004 Galomb
 2004/0226625 A1 11/2004 Galomb
 2004/0232029 A1 11/2004 Cotert
 2004/0251163 A1 12/2004 Conde et al.
 2005/0011906 A1 1/2005 Buck et al.
 2005/0053315 A1 3/2005 Aasen
 2005/0069230 A1 3/2005 Takahashi et al.
 2005/0109827 A1 5/2005 Martin
 2005/0150785 A1 7/2005 Julius et al.
 2005/0189367 A1 9/2005 Chasid et al.
 2005/0208188 A1 9/2005 Garwood
 2005/0276525 A1 12/2005 Hebert et al.
 2006/0076352 A1 4/2006 Peterson et al.
 2006/0283750 A1 12/2006 Villars et al.
 2007/0151887 A1 7/2007 Clark et al.
 2009/0039078 A1 2/2009 Sanfilippo et al.
 2009/0120828 A1 5/2009 Sanfilippo et al.
 2009/0152290 A1 6/2009 Wang et al.
 2010/0113240 A1 5/2010 Takita et al.
 2010/0140129 A1 6/2010 Sanfilippo et al.
 2011/0297690 A1 12/2011 Teys et al.
 2012/0125937 A1 5/2012 Ahlstrom et al.
 2014/0083897 A1 3/2014 Sanfilippo et al.
 2014/0102936 A1 4/2014 Sanfilippo et al.
 2014/0109522 A1 4/2014 Sanfilippo et al.

FOREIGN PATENT DOCUMENTS

FR 2766794 A1 2/1999
 JP 10-203560 8/1998
 WO WO-86/06344 A1 11/1986
 WO WO-00/12407 A1 3/2000
 WO WO-02/085726 A1 10/2002
 WO WO-2004/110885 A1 12/2004

OTHER PUBLICATIONS

Color photographs of Frito-Lay Doritos "Gamer Pack" package (circa 2013).

* cited by examiner

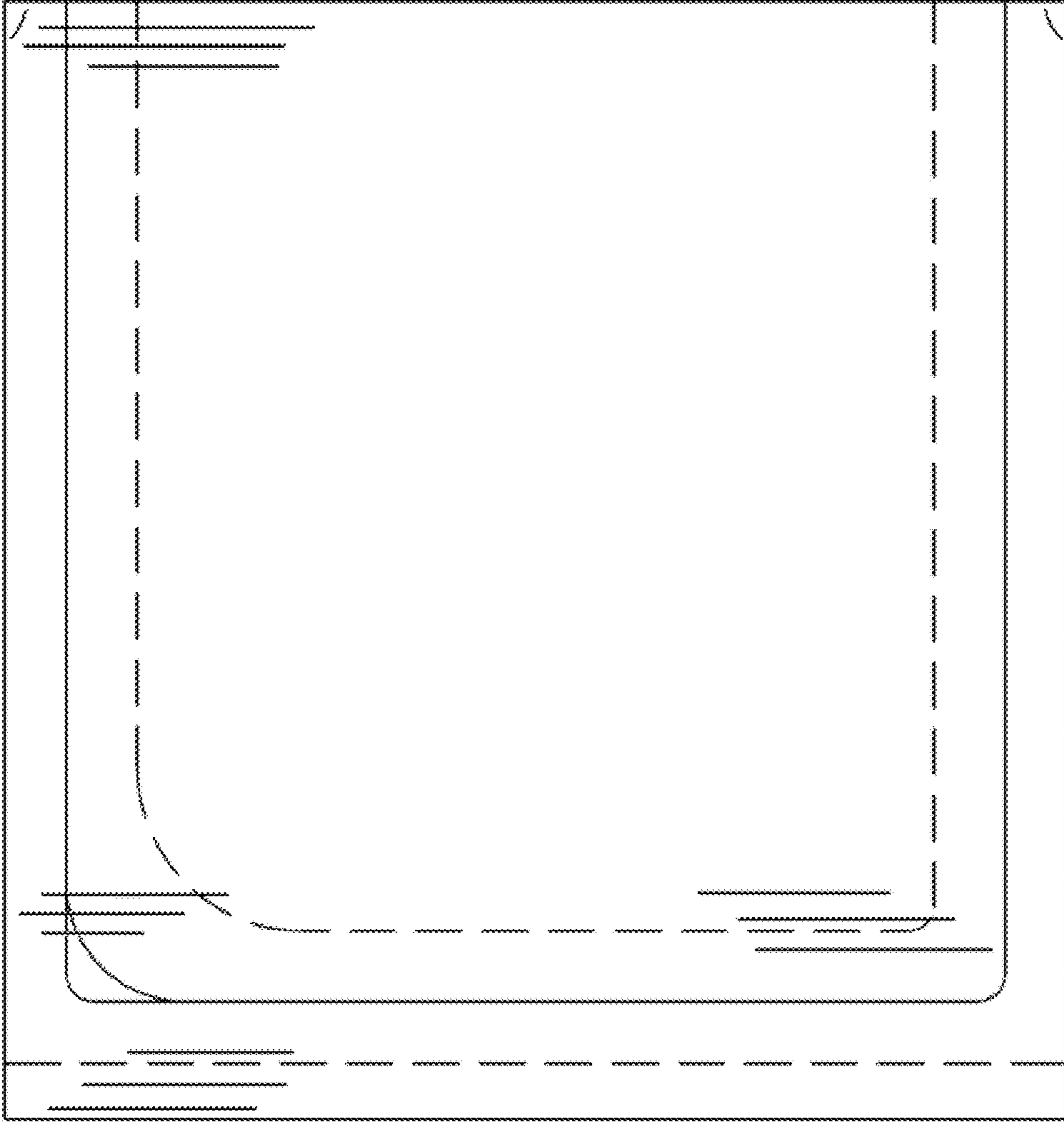

Fig. 1



Fig. 2

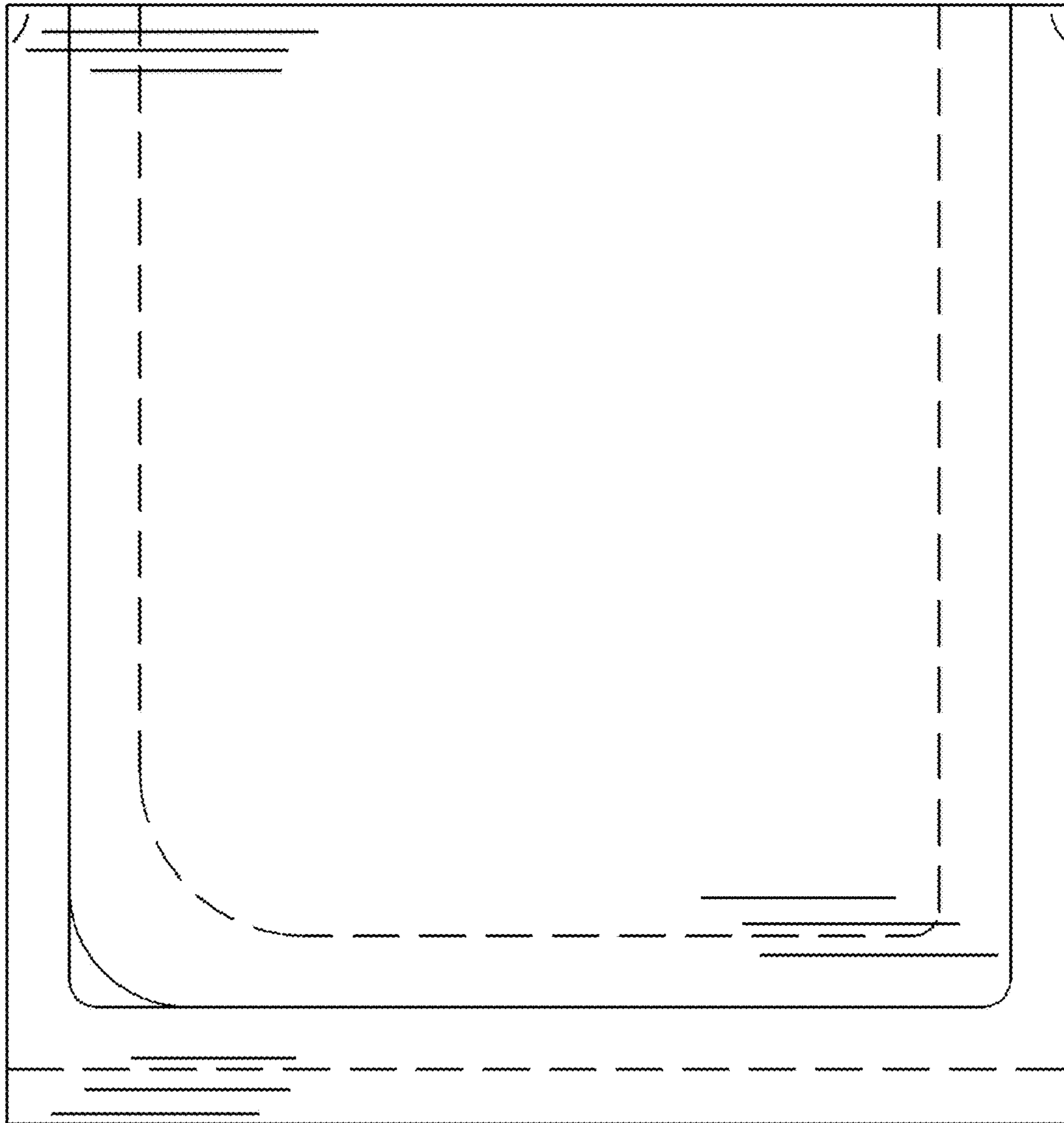

Fig. 3

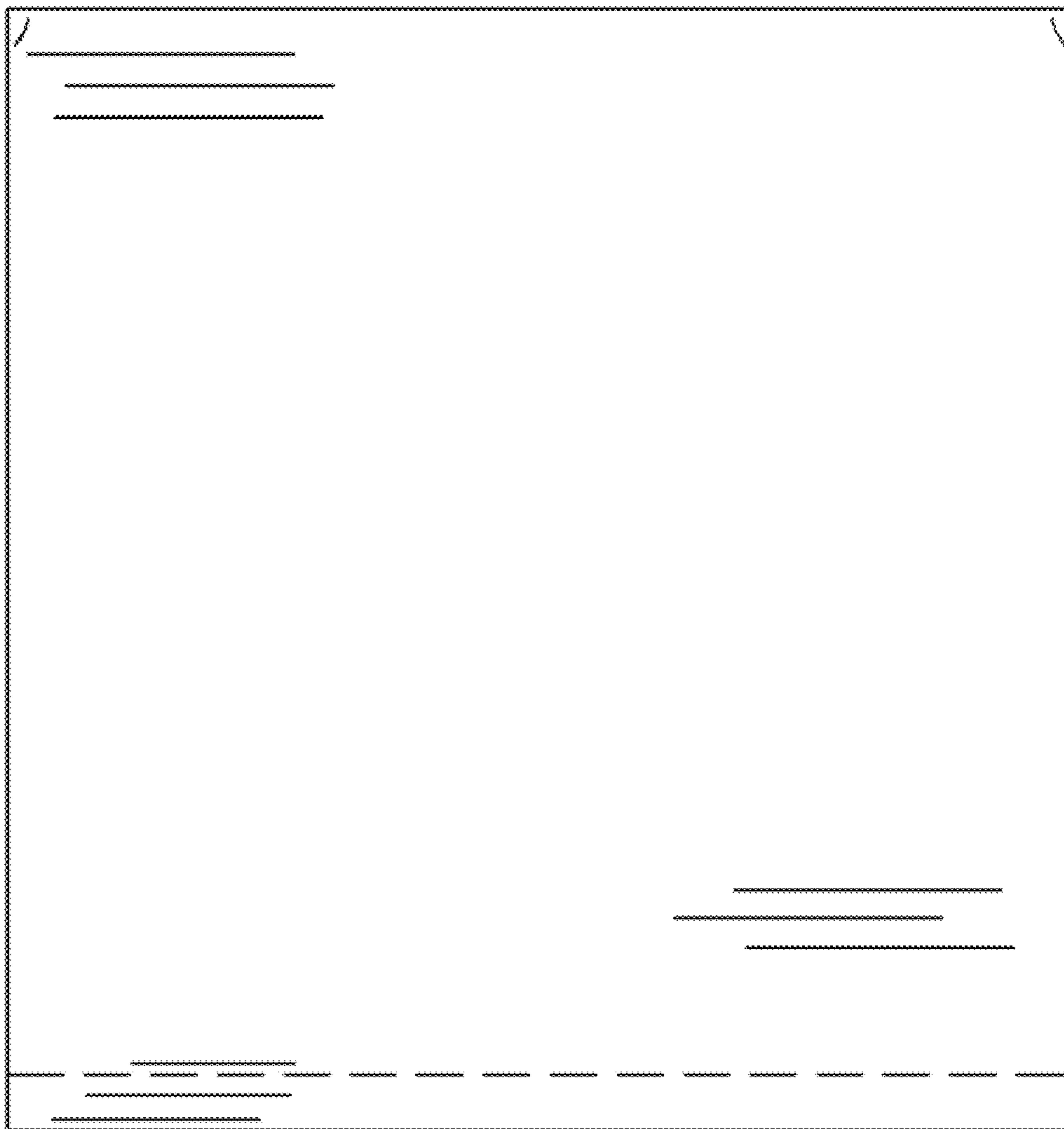

Fig. 4

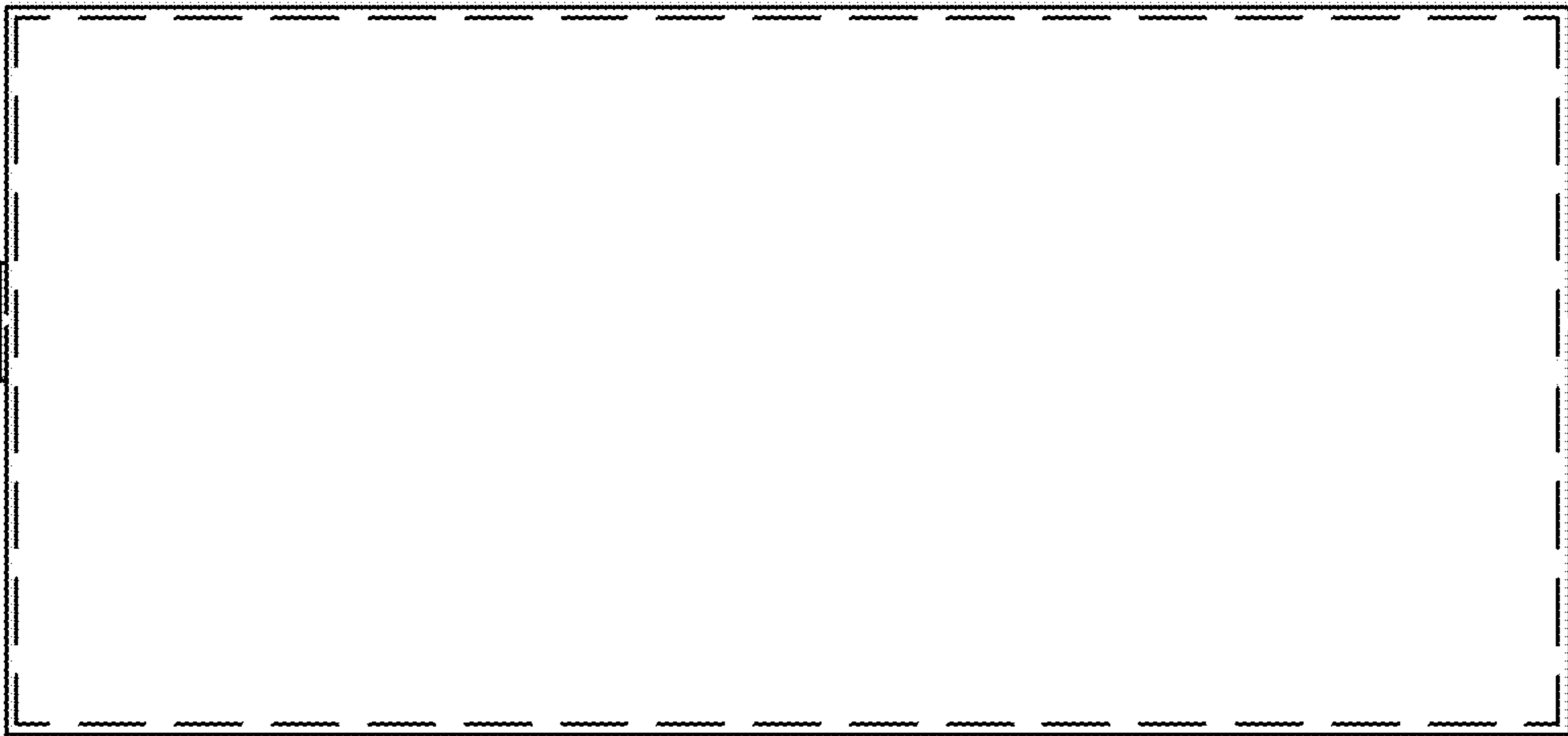

Fig. 5

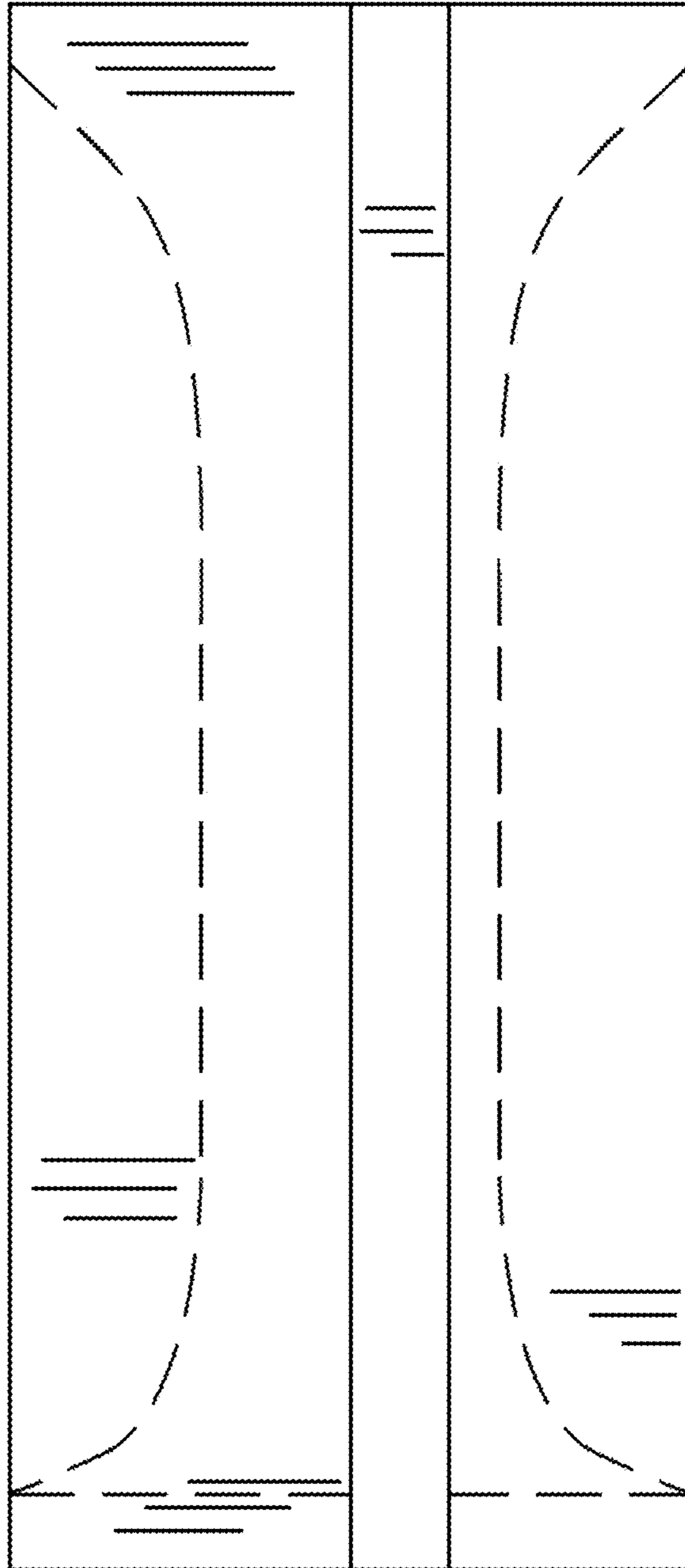

Fig. 6

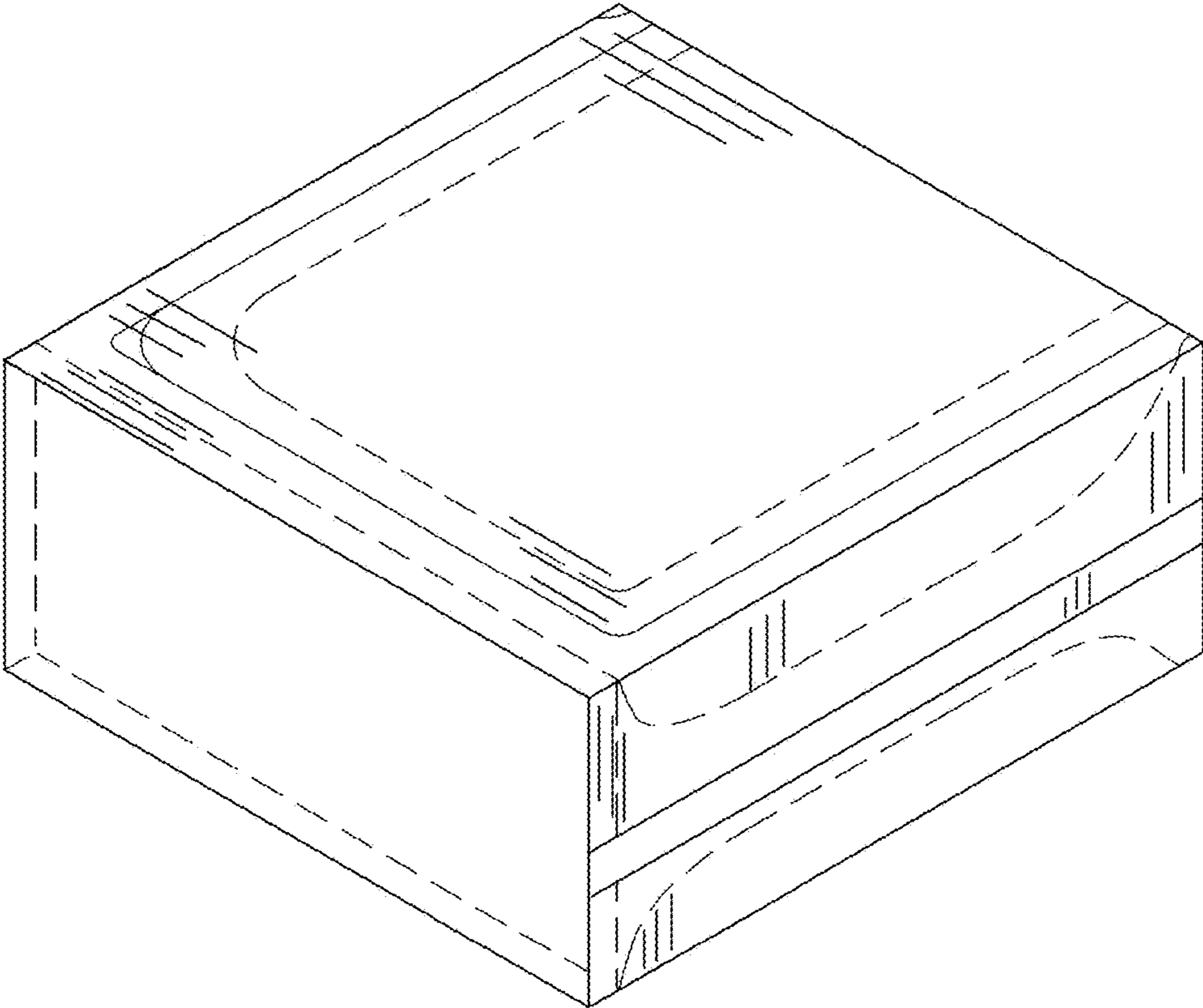

Fig. 7