



US00D778634S

(12) **United States Design Patent** (10) **Patent No.:** **US D778,634 S**
Locker (45) **Date of Patent:** **** Feb. 14, 2017**

- (54) **PAPER TOWEL HOLDER**
- (71) Applicant: **Howard J. Locker**, Dallas, TX (US)
- (72) Inventor: **Howard J. Locker**, Dallas, TX (US)
- (**) Term: **15 Years**
- (21) Appl. No.: **29/544,545**
- (22) Filed: **Nov. 4, 2015**

- D522,293 S 6/2006 Yang et al.
- D523,268 S * 6/2006 Goodman D6/521
- D545,599 S 7/2007 Yu
- D555,954 S * 11/2007 Yang D6/521

(Continued)

Primary Examiner — David Muller
Assistant Examiner — Nathan Johnston
 (74) *Attorney, Agent, or Firm* — Washam PLLC; Steven H. Washam

Related U.S. Application Data

- (63) Continuation-in-part of application No. 29/497,440, filed on Jul. 24, 2014, now Pat. No. Des. 761,039.
- (51) **LOC (10) Cl.** **20-02**
- (52) **U.S. Cl.**
USPC **D6/521**
- (58) **Field of Classification Search**
USPC D6/518–523; 206/389, 391; 211/13.1, 211/59.1, 45, 890.1, 16, 85.5, 86.01, 211/87.01, 88.04, 100, 105.1, 105.2, 106, 211/113, 123, 181.1, 182–183; 242/570, 242/590, 597.7, 309.1, 309.2; D25/45; D8/300, 370, 315; 108/28–29
CPC A47K 10/3836; A47K 2010/3863; B26F 3/02; Y10T 225/282
See application file for complete search history.

(57) **CLAIM**

I claim the ornamental design for a paper towel holder, as shown and described.

DESCRIPTION

FIG. 1 is a perspective view of a paper towel holder showing my new design;
 FIG. 2 is a front elevational view thereof;
 FIG. 3 is a rear elevational view thereof;
 FIG. 4 is a left side elevational view thereof;
 FIG. 5 is a right side elevational view thereof;
 FIG. 6 is a top elevational view thereof;
 FIG. 7 is a bottom elevational view thereof;
 FIG. 8 is a bottom elevational view thereof, depicting an alternate embodiment of FIG. 7, additional FIGS. 1-6 applied there to;
 FIG. 9 is a perspective view thereof, depicting the flashlight in an unattached and displaced state;
 FIG. 10 is a front elevational view thereof;
 FIG. 11 is a rear elevational view thereof;
 FIG. 12 is a left side elevational view thereof;
 FIG. 13 is a right side elevational view thereof;
 FIG. 14 is a top elevational view thereof; and,
 FIG. 15 is a bottom elevational view thereof.
 The broken lines shown in the figures represent portions of paper towel holder that form no part of the claimed design. A characteristic feature of the design resides in the detachable flashlight located in the paper towel holder primary stem.

(56) **References Cited**

U.S. PATENT DOCUMENTS

- 4,714,211 A * 12/1987 Hwang B65B 67/085
242/423.1
- D306,809 S 3/1990 Joseph
- D356,226 S * 3/1995 Hay D6/521
- D419,013 S 1/2000 Tisdale
- D432,827 S * 10/2000 Lillelund D6/521
- D432,828 S 10/2000 Snell
- D474,634 S 5/2003 Ancona
- D499,915 S 12/2004 Snell
- D520,278 S * 5/2006 Mariano D6/521
- D522,292 S * 6/2006 Goodman D6/521

1 Claim, 14 Drawing Sheets

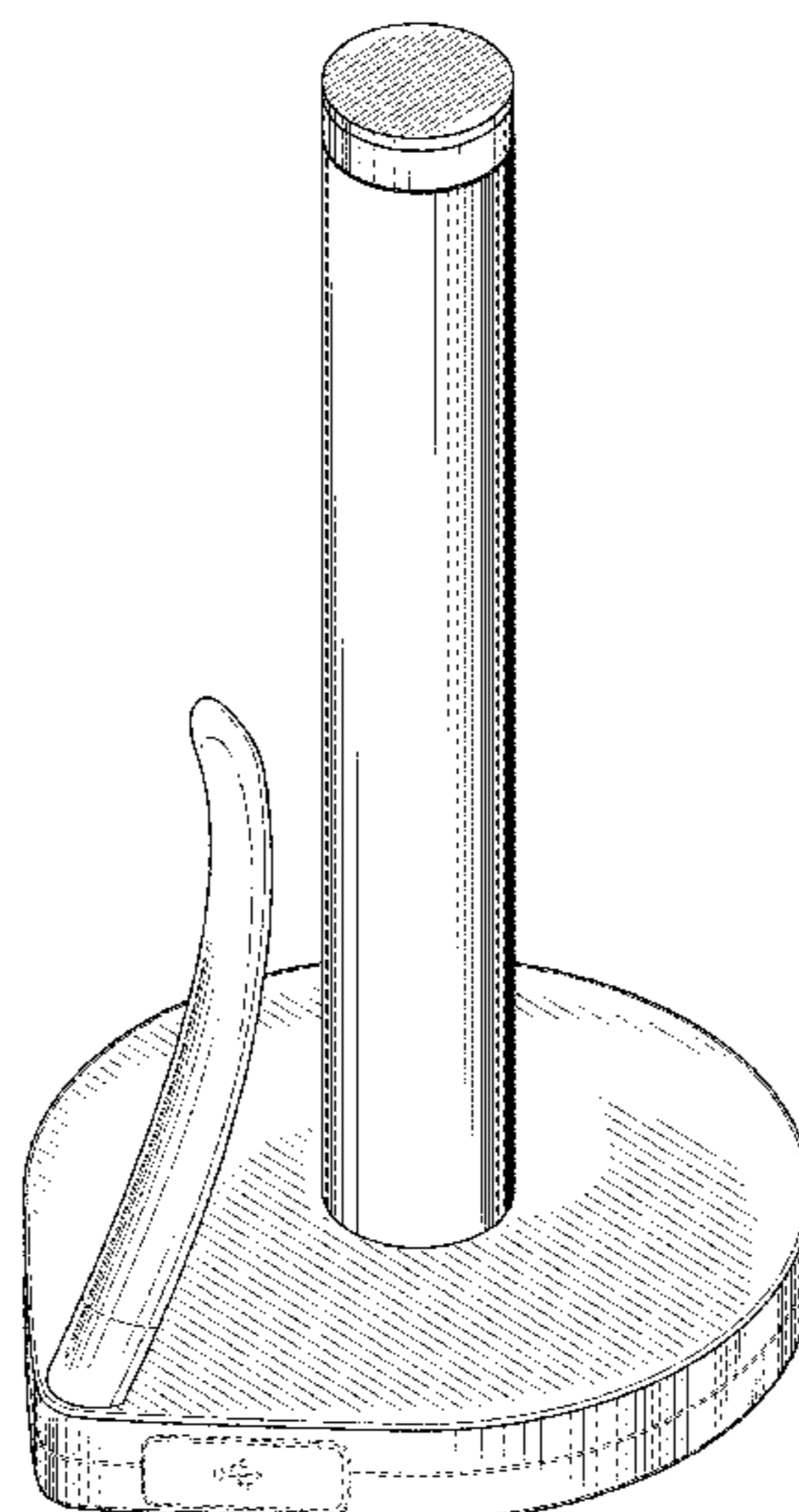

(56)

References Cited

U.S. PATENT DOCUMENTS

D562,042	S	2/2008	Shek	
D563,130	S *	3/2008	Griffith	D6/521
D596,433	S	7/2009	Brewster	
D609,949	S	2/2010	Yang et al.	
D626,771	S *	11/2010	Shek	D6/521
D635,806	S *	4/2011	Bodum	D6/521
D670,115	S *	11/2012	Seehoff	D6/521
D704,473	S	5/2014	Hartshorn et al.	
D713,166	S	9/2014	Miller et al.	
D716,578	S	11/2014	McCauley	
2002/0070308	A1 *	6/2002	Fahringer	A47K 10/38 242/423.2
2004/0159738	A1	8/2004	Duncan et al.	
2004/0195429	A1	10/2004	Demers et al.	
2009/0079526	A1	3/2009	Tong et al.	

* cited by examiner

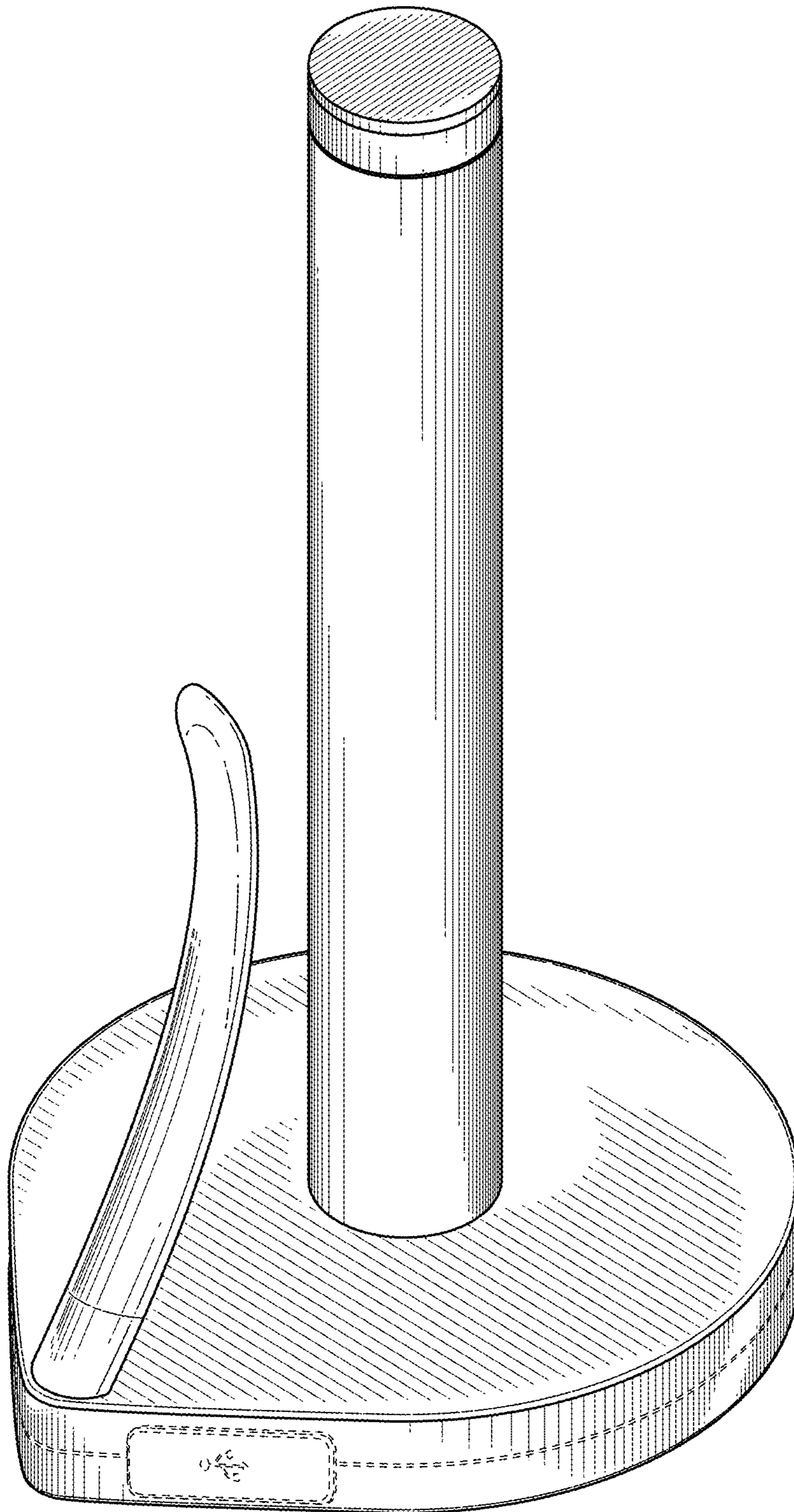

FIG. 1

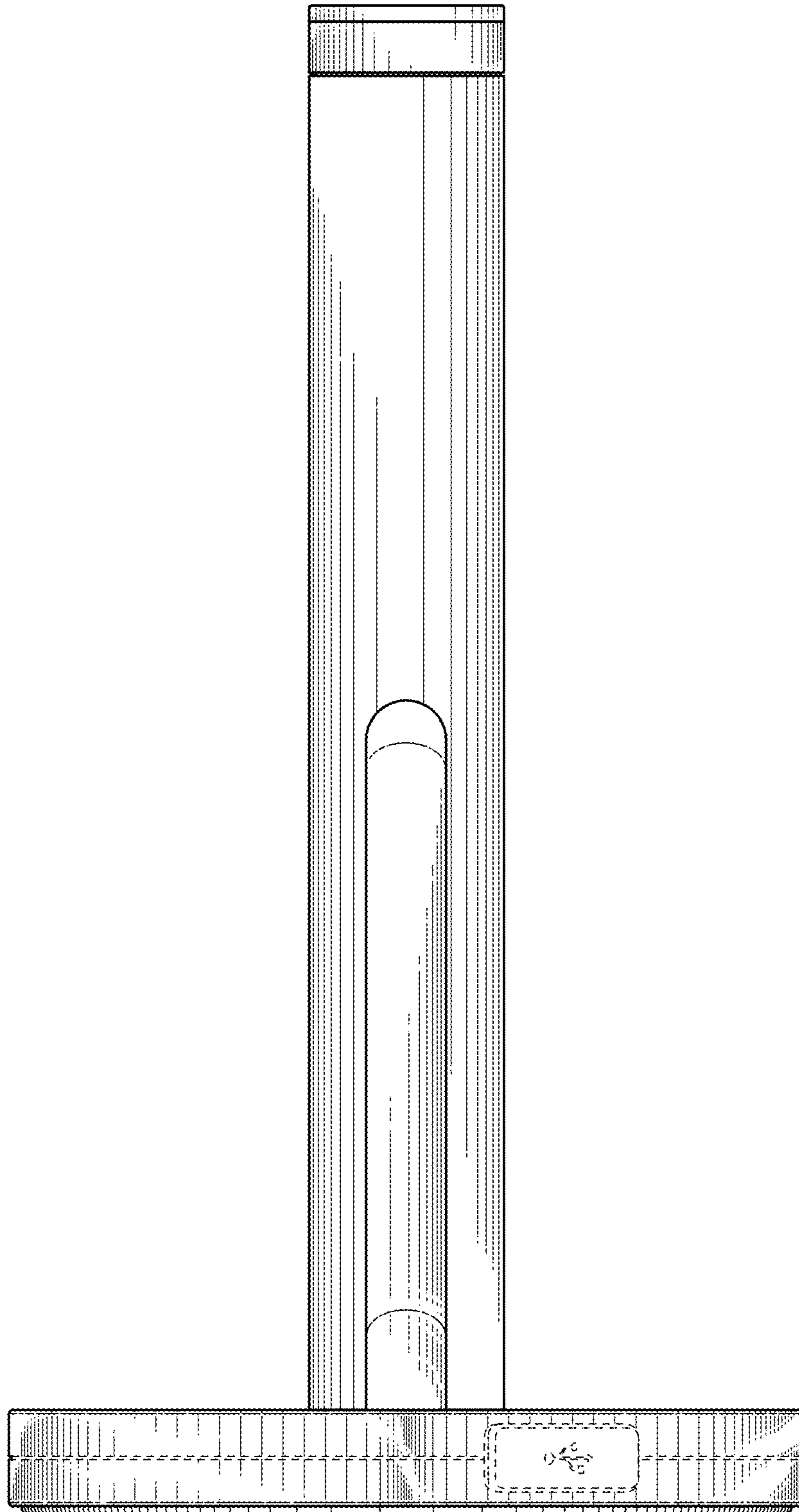

FIG. 2

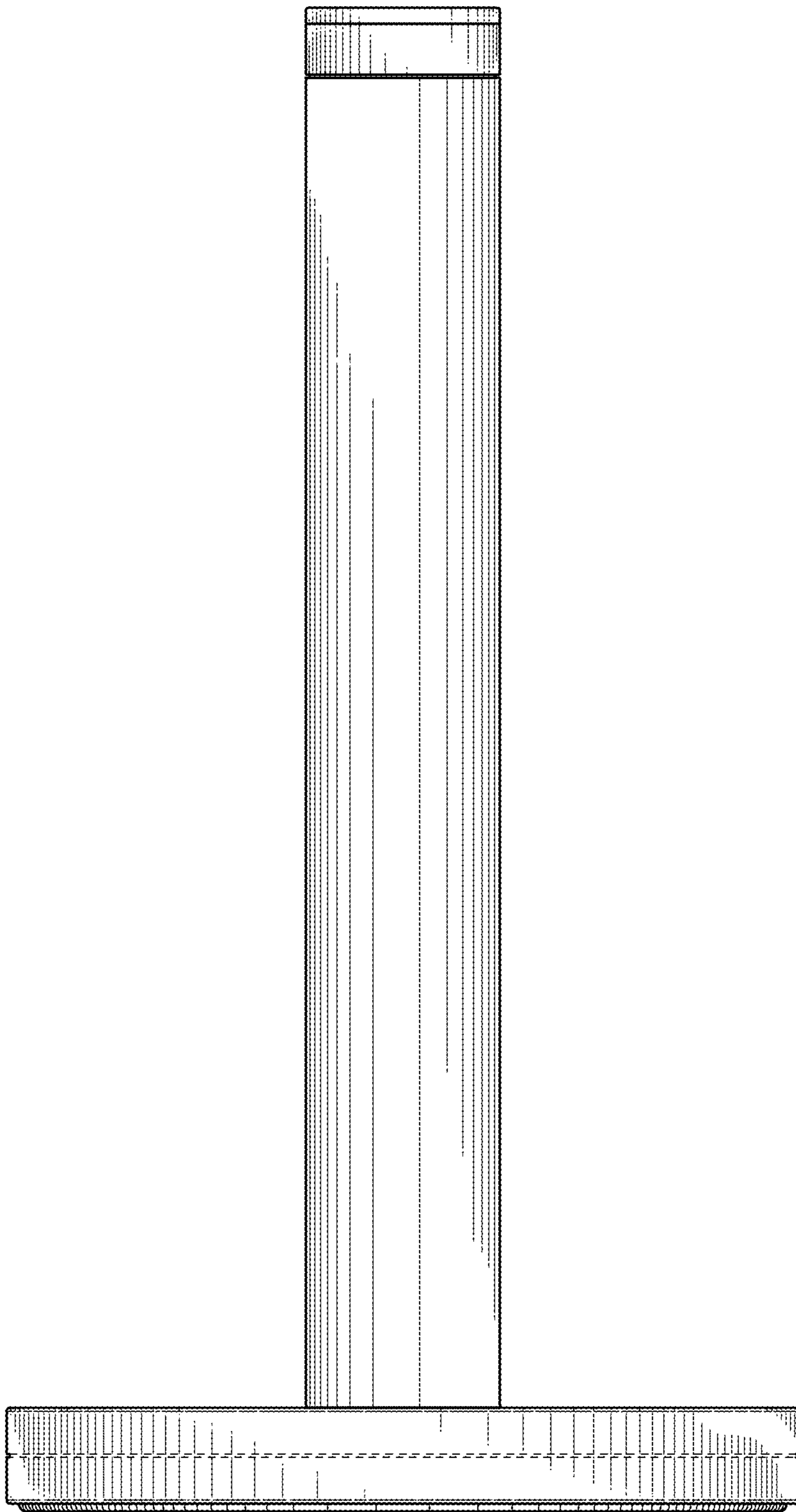

FIG. 3

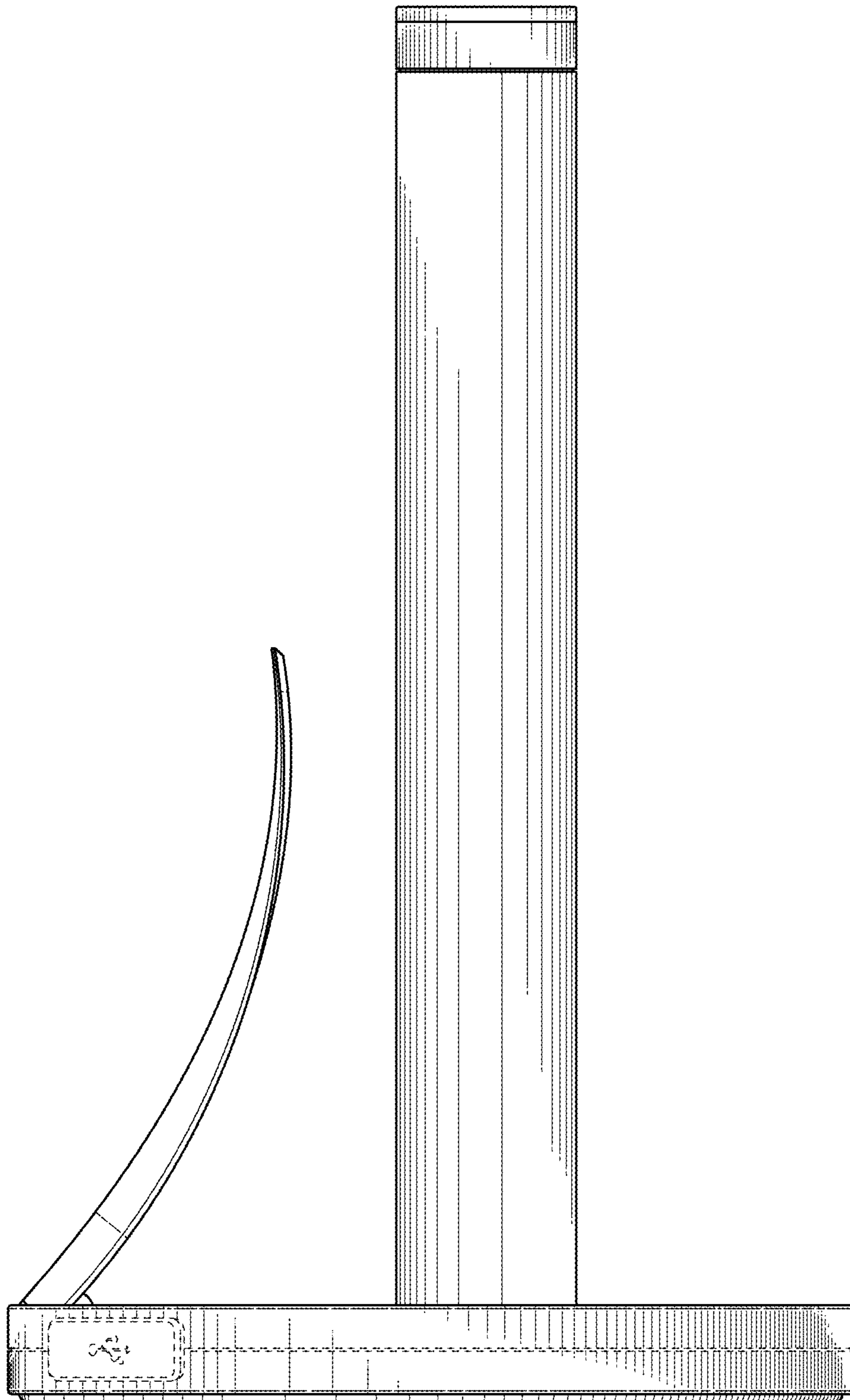

FIG. 4

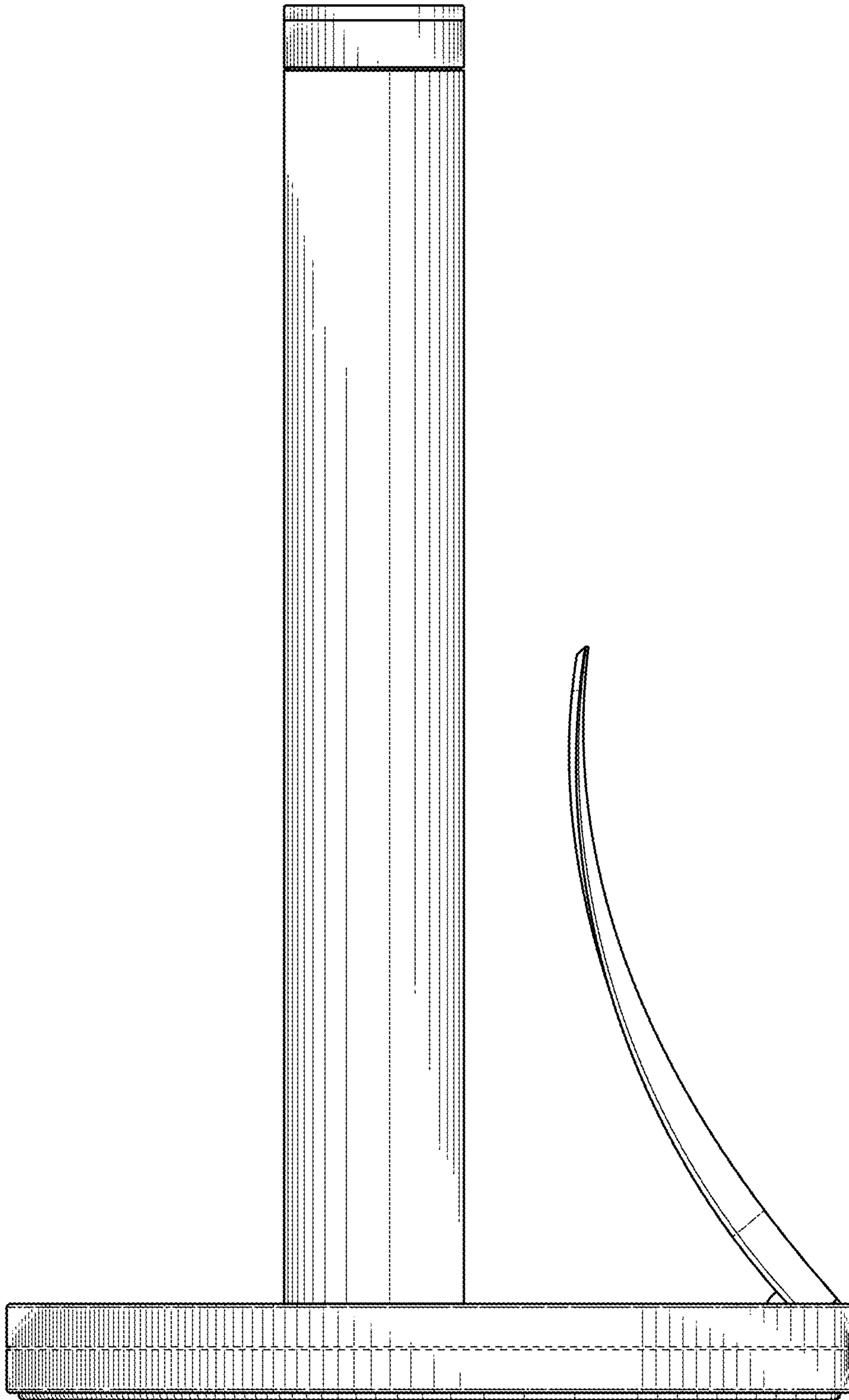

FIG. 5

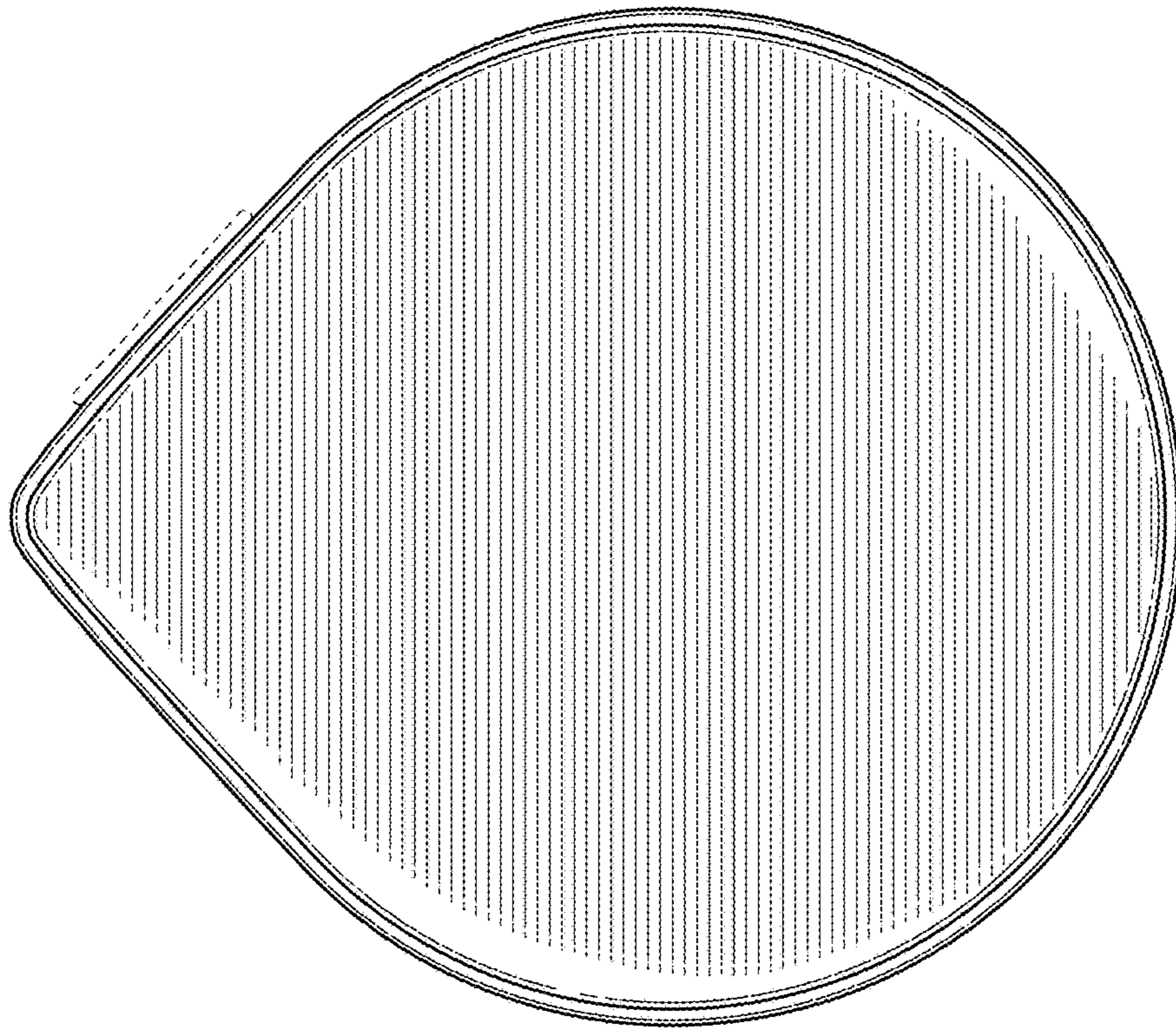

FIG. 7

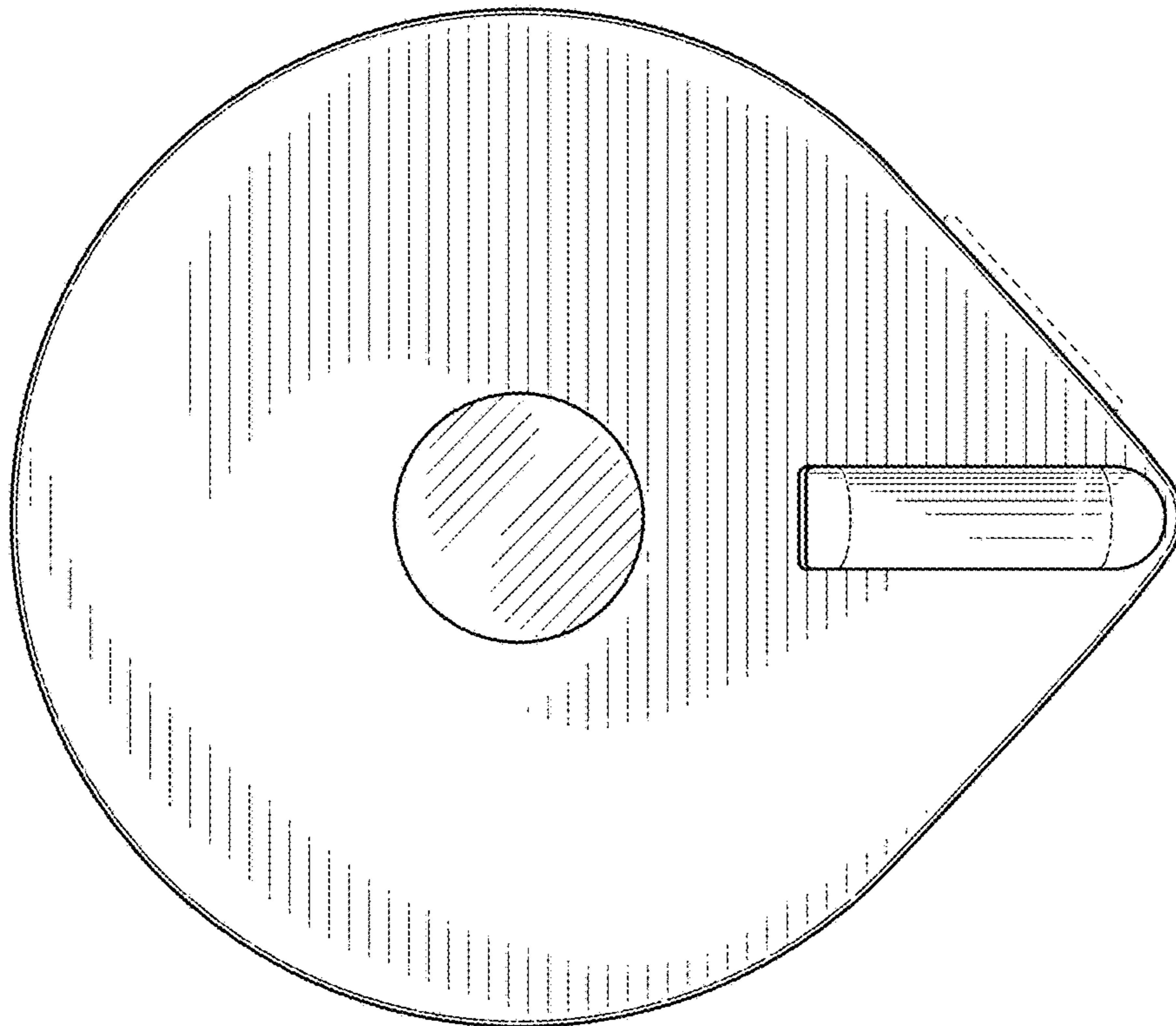

FIG. 6

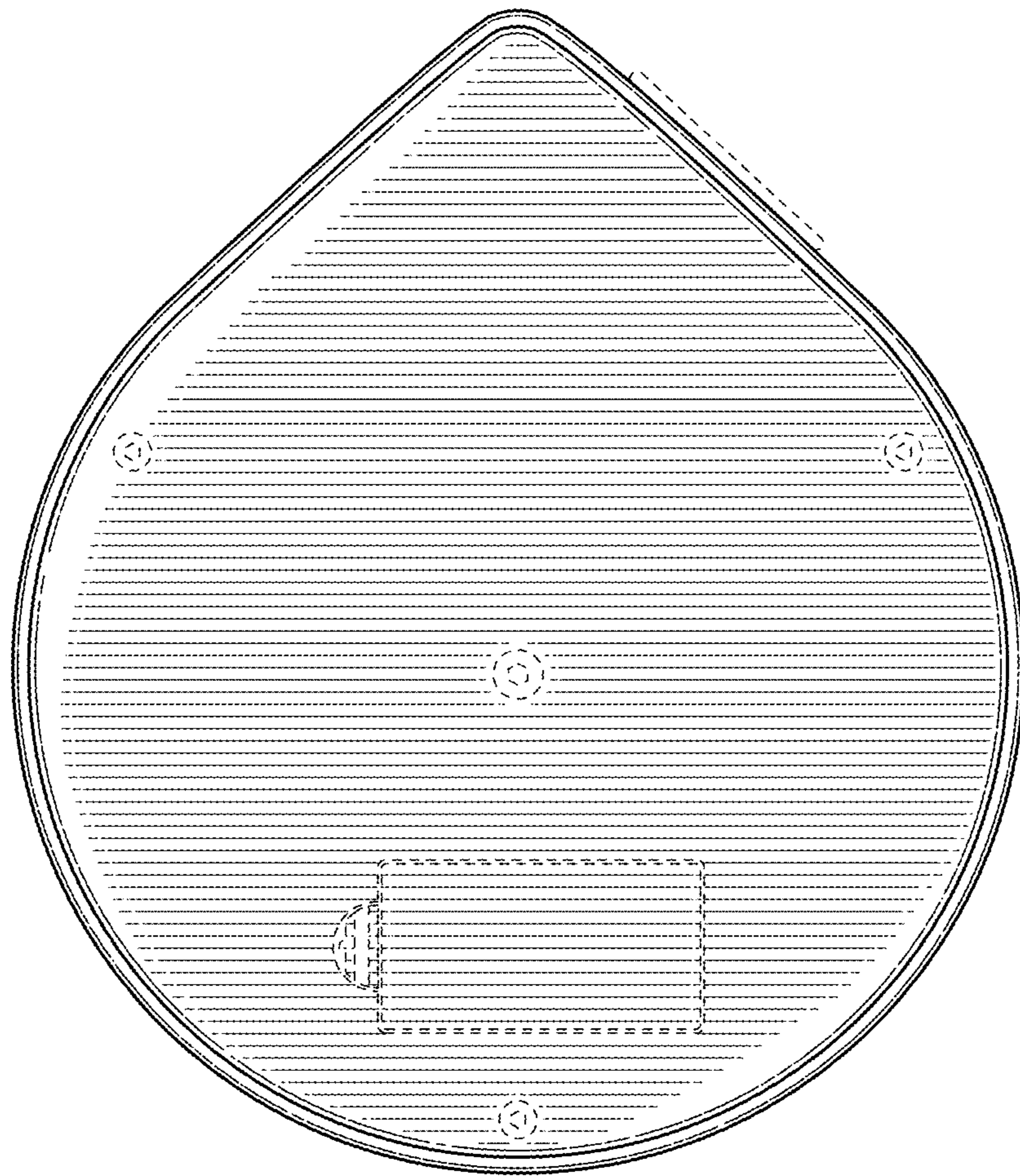

FIG. 8

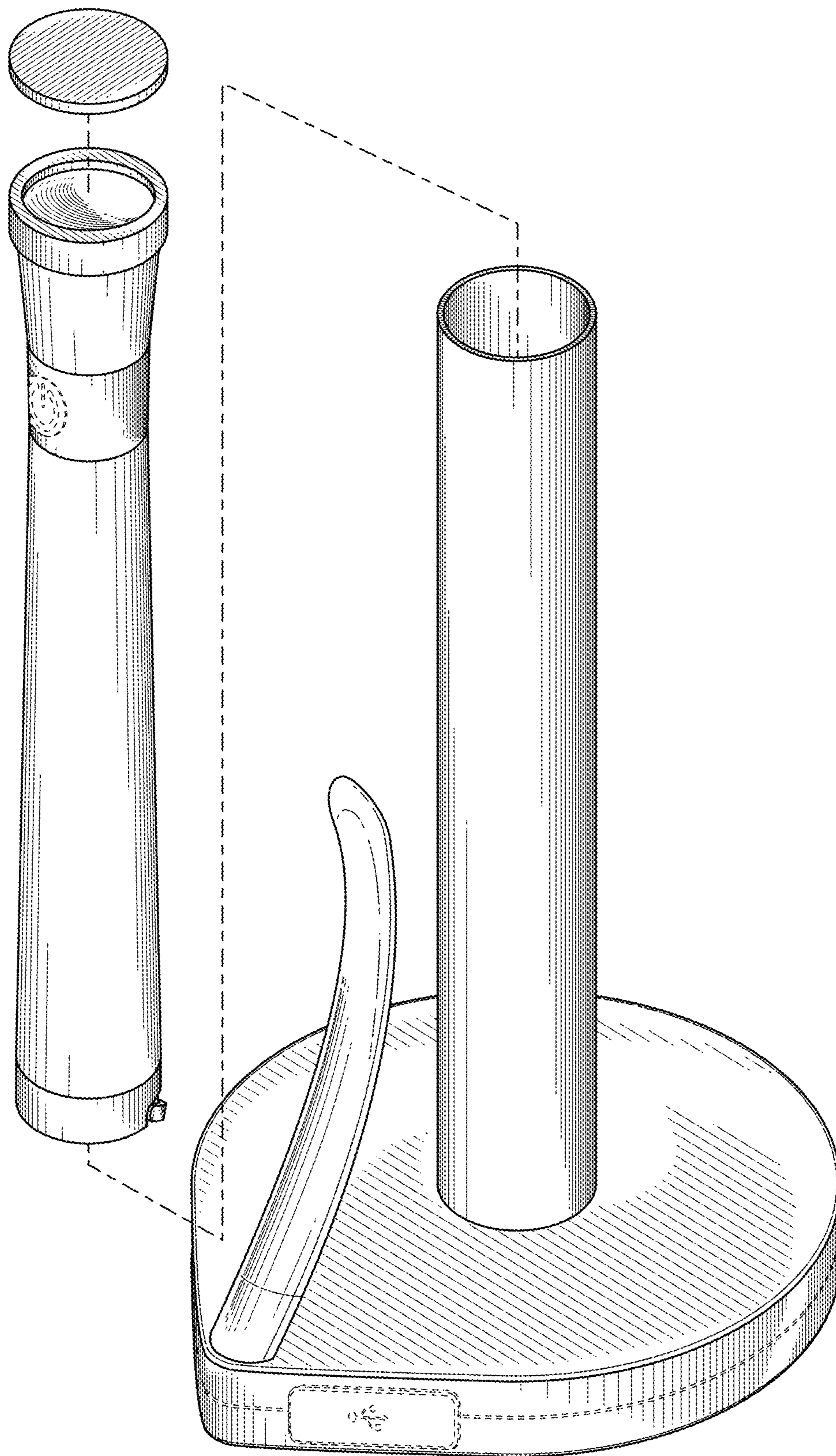

FIG. 9

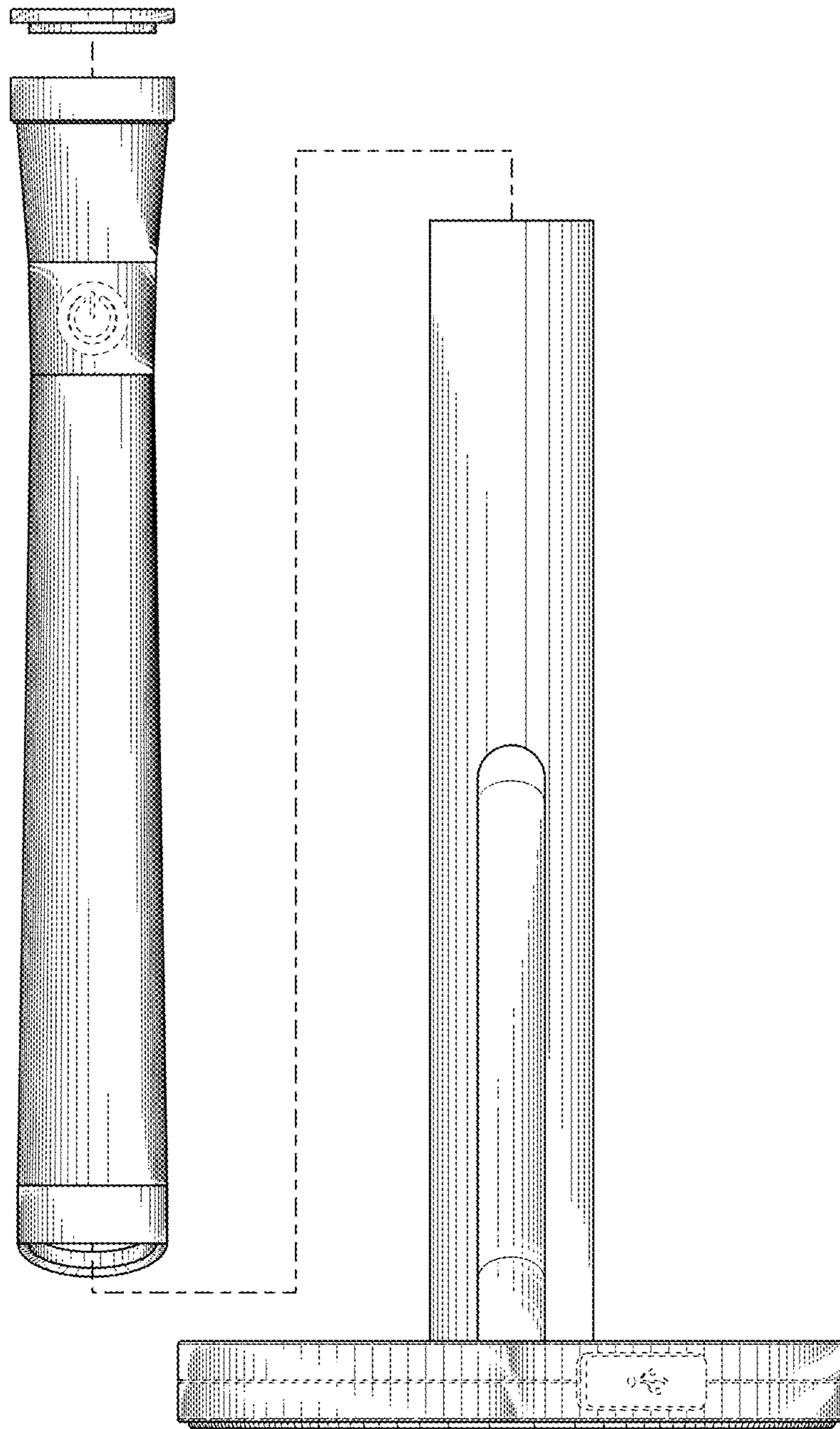

FIG. 10

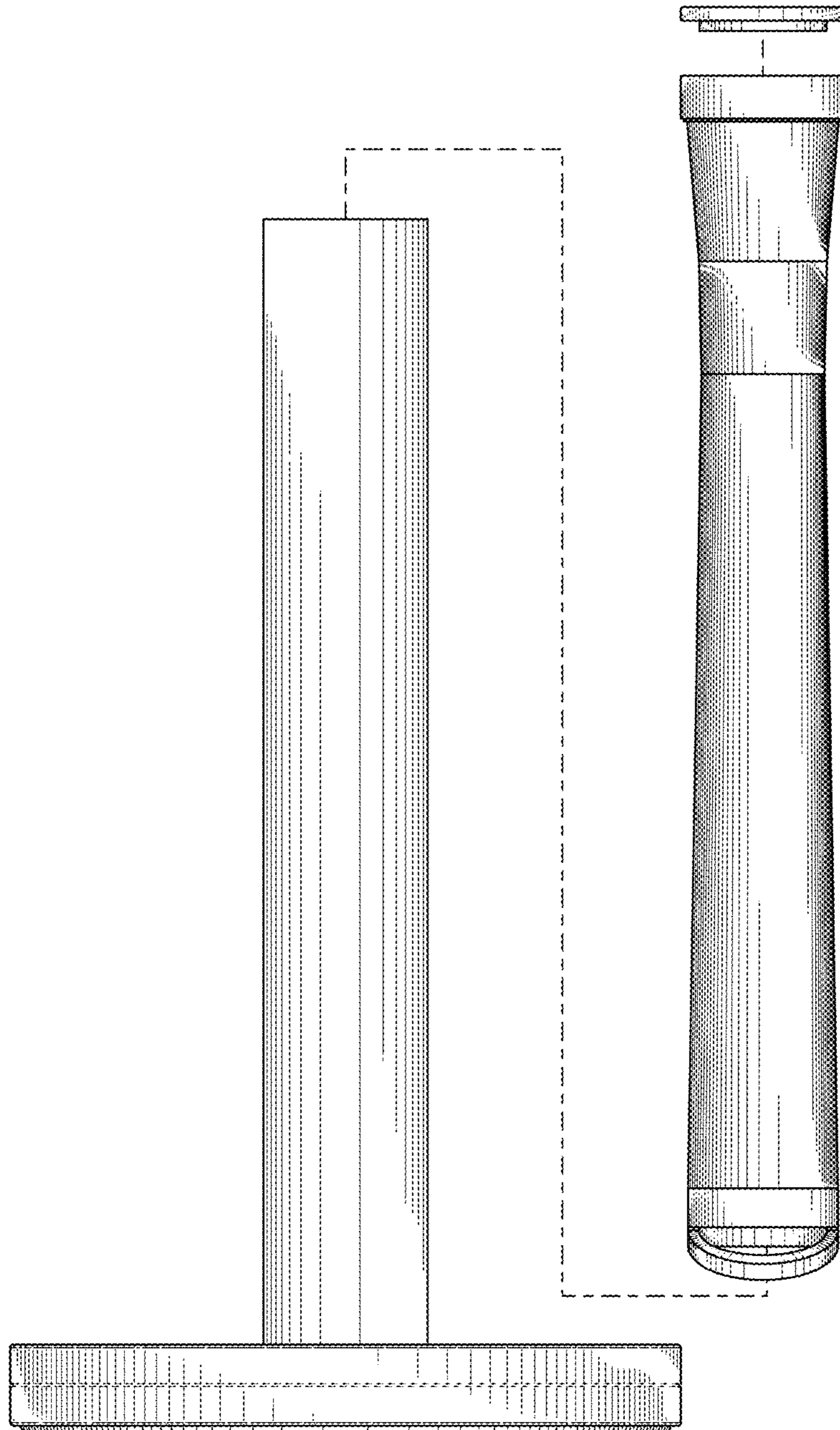

FIG. 11

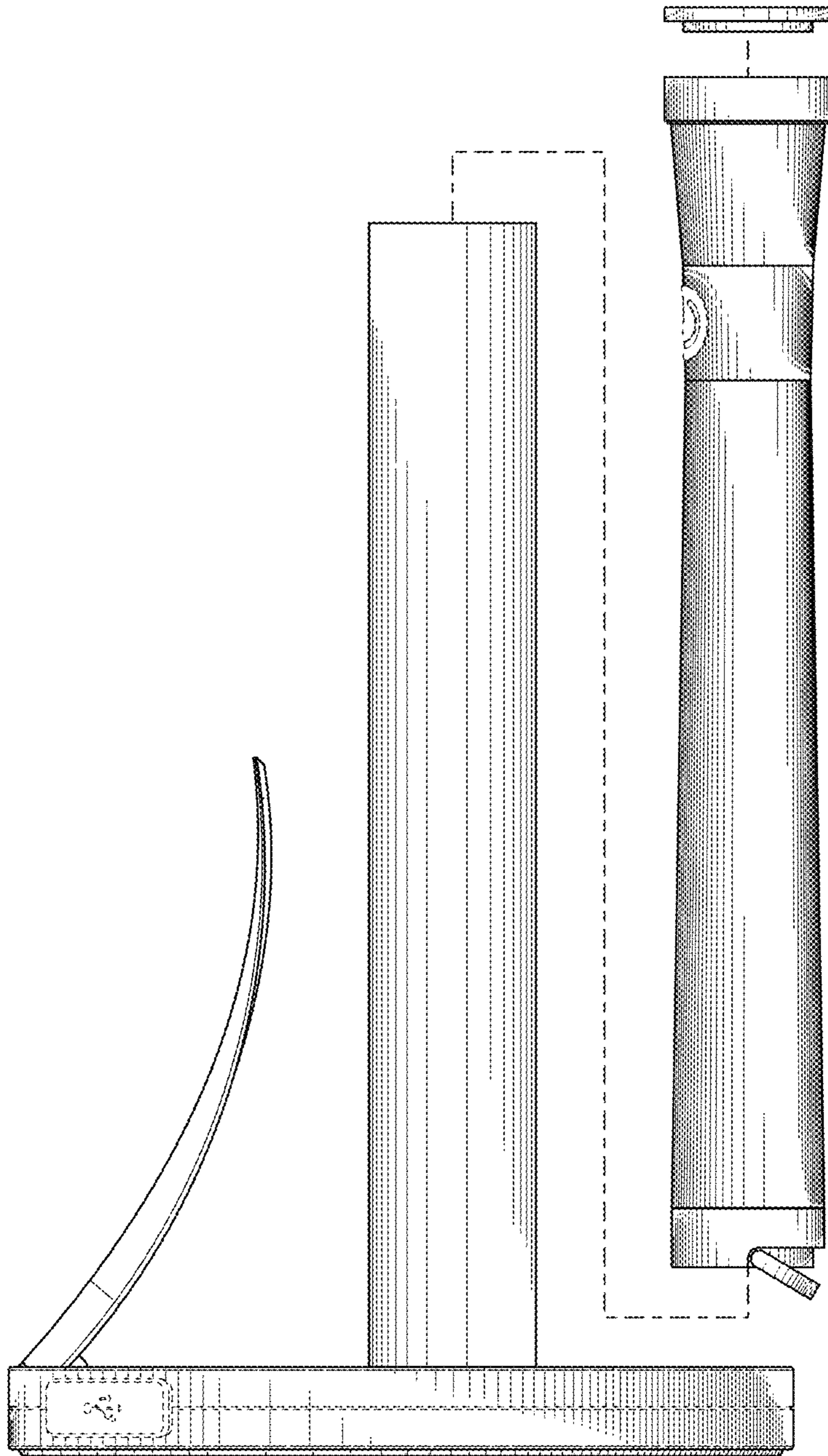

FIG. 12

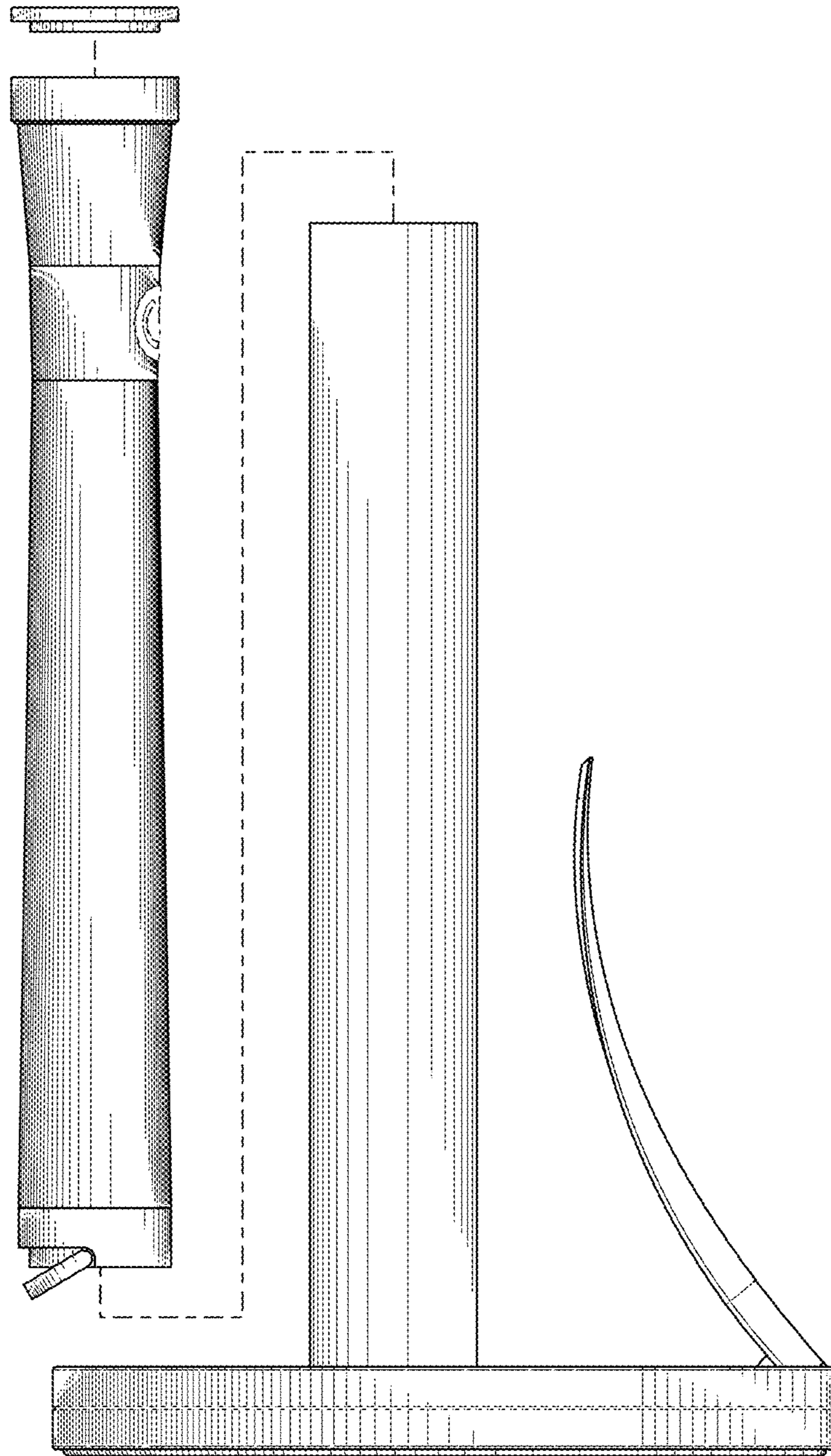

FIG. 13

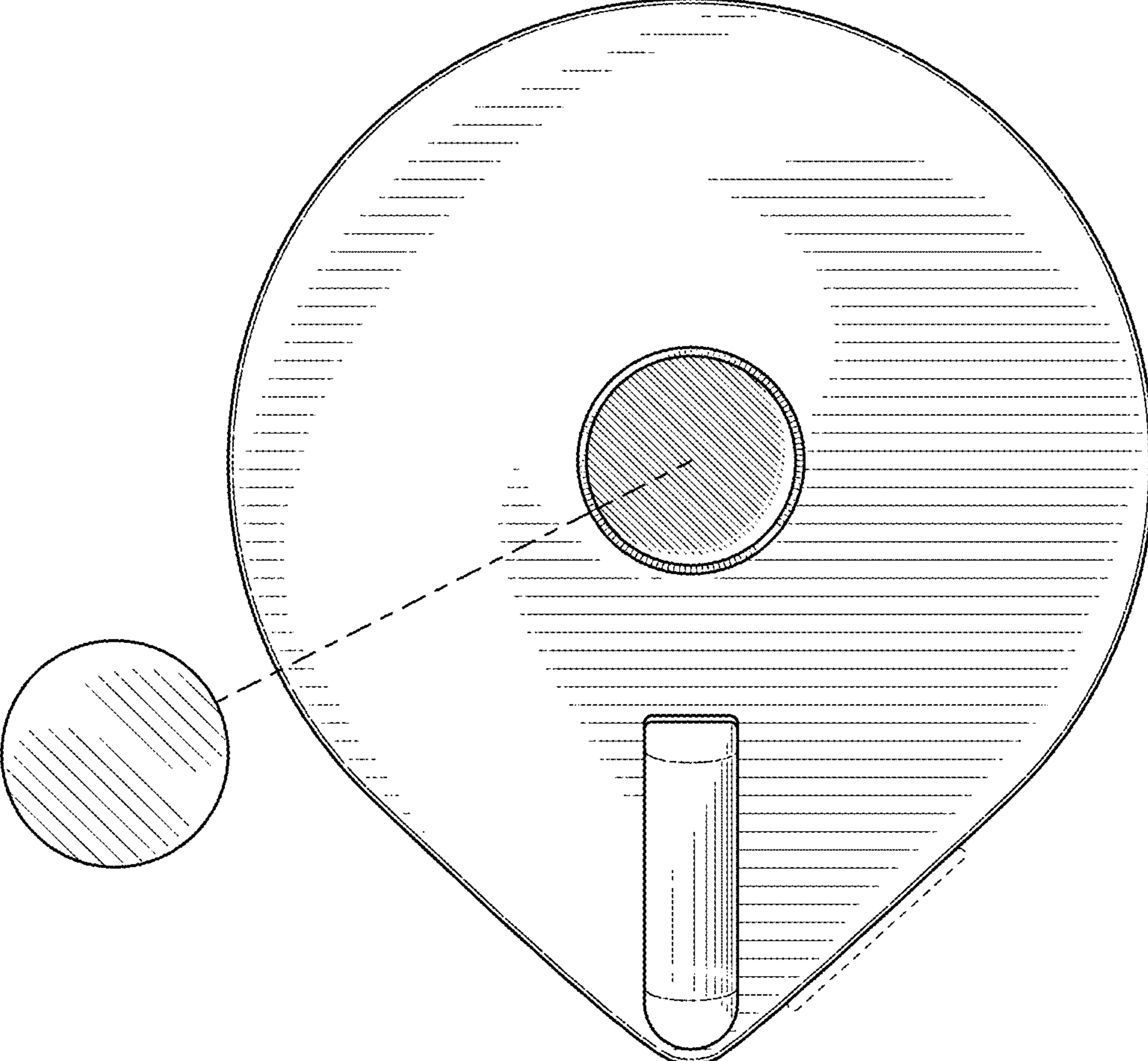

FIG. 14

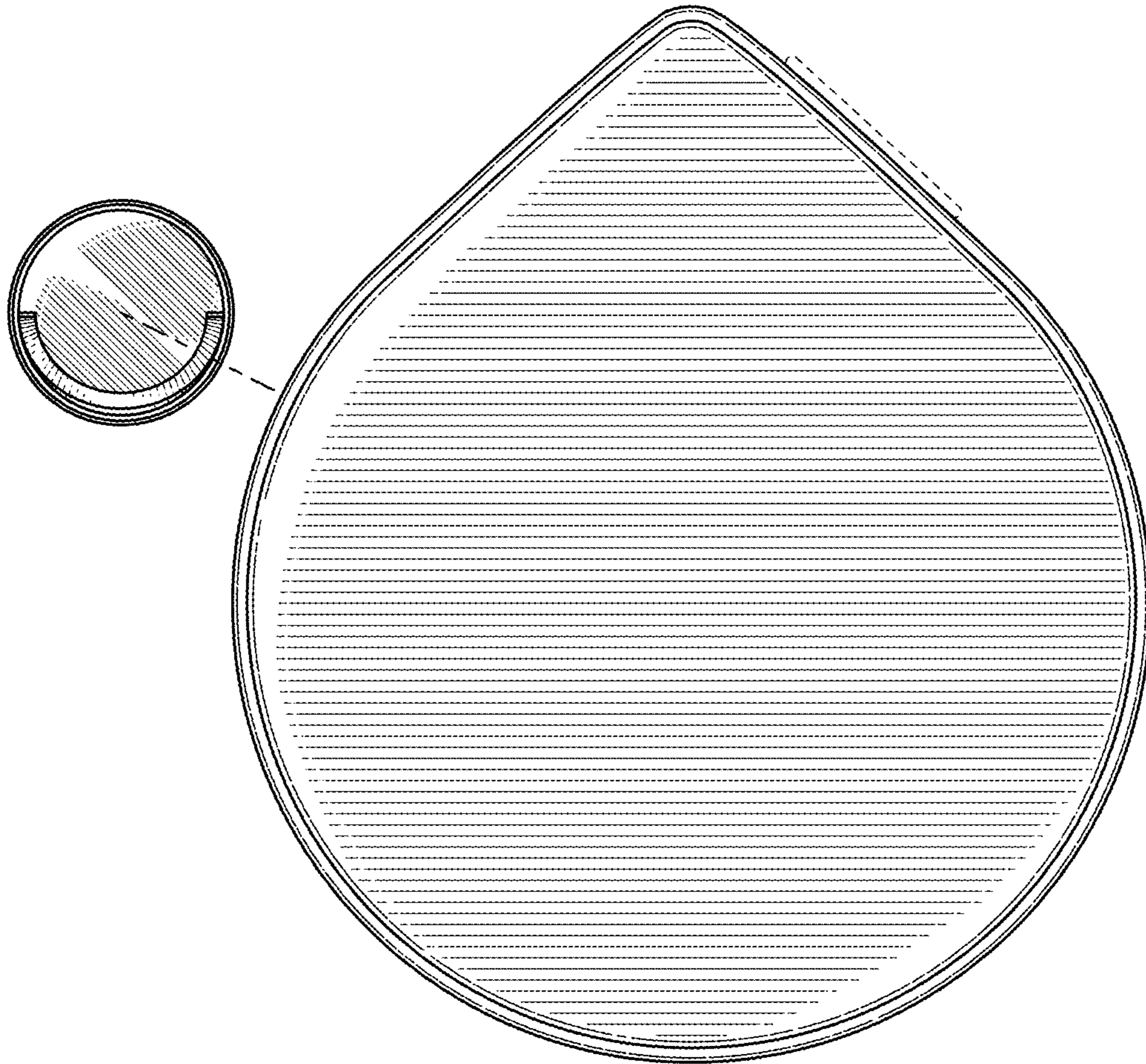

FIG. 15