



US00D778603S

(12) **United States Design Patent**
Heyman

(10) **Patent No.:** **US D778,603 S**

(45) **Date of Patent:** **** Feb. 14, 2017**

(54) **HANDBAG**

D730,041 S * 5/2015 Landry D3/232
D730,643 S * 6/2015 Langer D3/232
D761,556 S * 7/2016 Sassi D3/232

(71) Applicant: **Edie Parker LLC**, New York, NY (US)

* cited by examiner

(72) Inventor: **Brett Heyman**, New York, NY (US)

Primary Examiner — Holly Baynham

(73) Assignee: **Edie Parker LLC**, New York, NY (US)

(74) *Attorney, Agent, or Firm* — Springut Law PC;
Milton Springut

(**) Term: **15 Years**

(21) Appl. No.: **29/551,377**

(57) **CLAIM**

The ornamental design of a handbag, as shown and described.

(22) Filed: **Jan. 13, 2016**

(51) **LOC (10) Cl.** **03-01**

DESCRIPTION

(52) **U.S. Cl.**

USPC **D3/243**

(58) **Field of Classification Search**

USPC D3/232–233, 240–243, 245–246

CPC A45C 1/024; A45C 3/06

See application file for complete search history.

FIG. 1 is a perspective view thereof.

FIG. 2 is a front view thereof.

FIG. 3 is a rear view thereof.

FIG. 4 is a left side view thereof.

FIG. 5 is a right side view thereof.

FIG. 6 is a top view thereof; and,

FIG. 7 is a bottom view thereof.

The broken lines showing a portion of the handbag are for the purposes of illustrating environment and form no part of the claimed design.

(56) **References Cited**

U.S. PATENT DOCUMENTS

D669,264 S * 10/2012 Gonzalez D3/243

D675,429 S * 2/2013 Della Valle D3/243

1 Claim, 7 Drawing Sheets

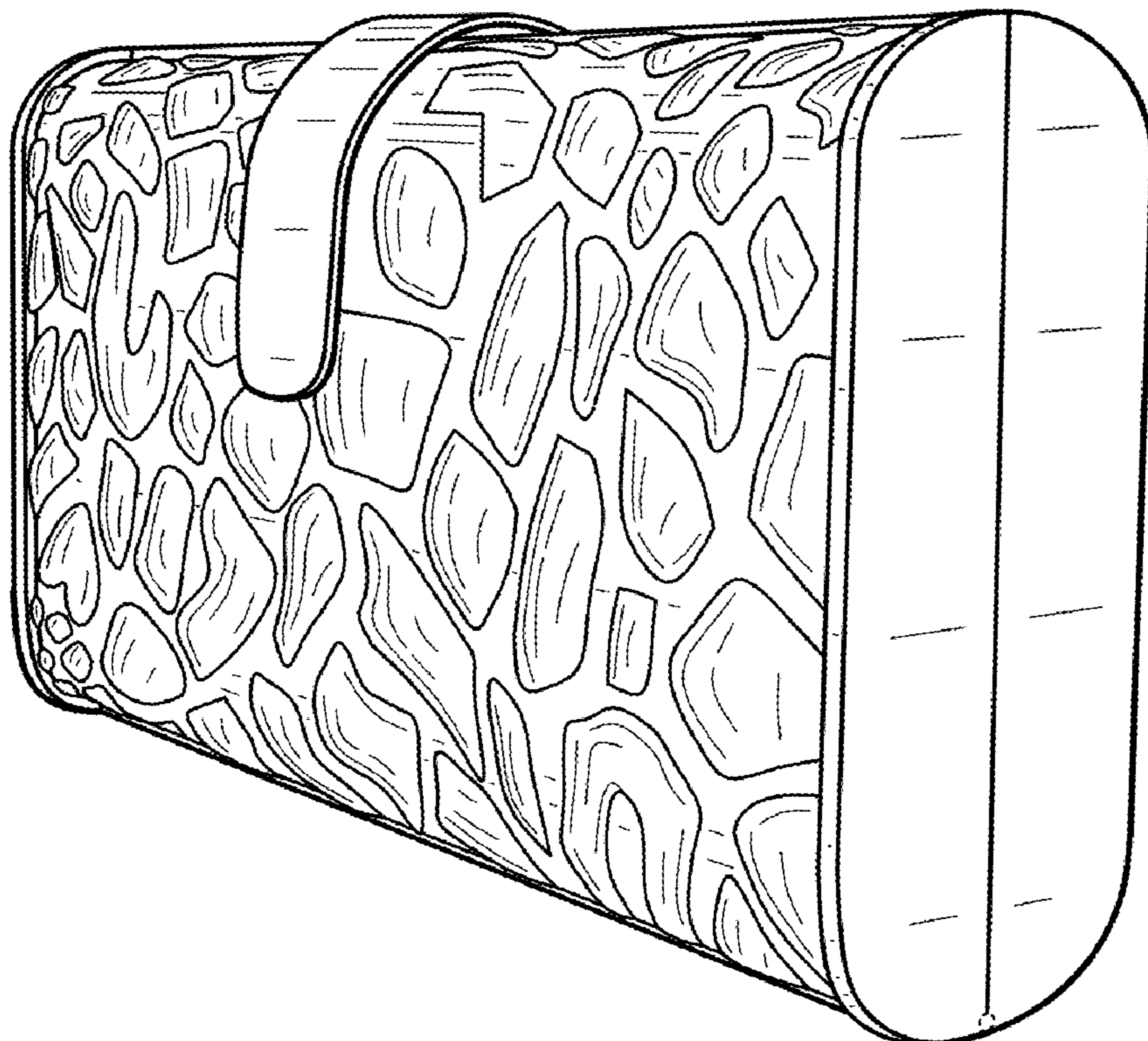

FIG. 1

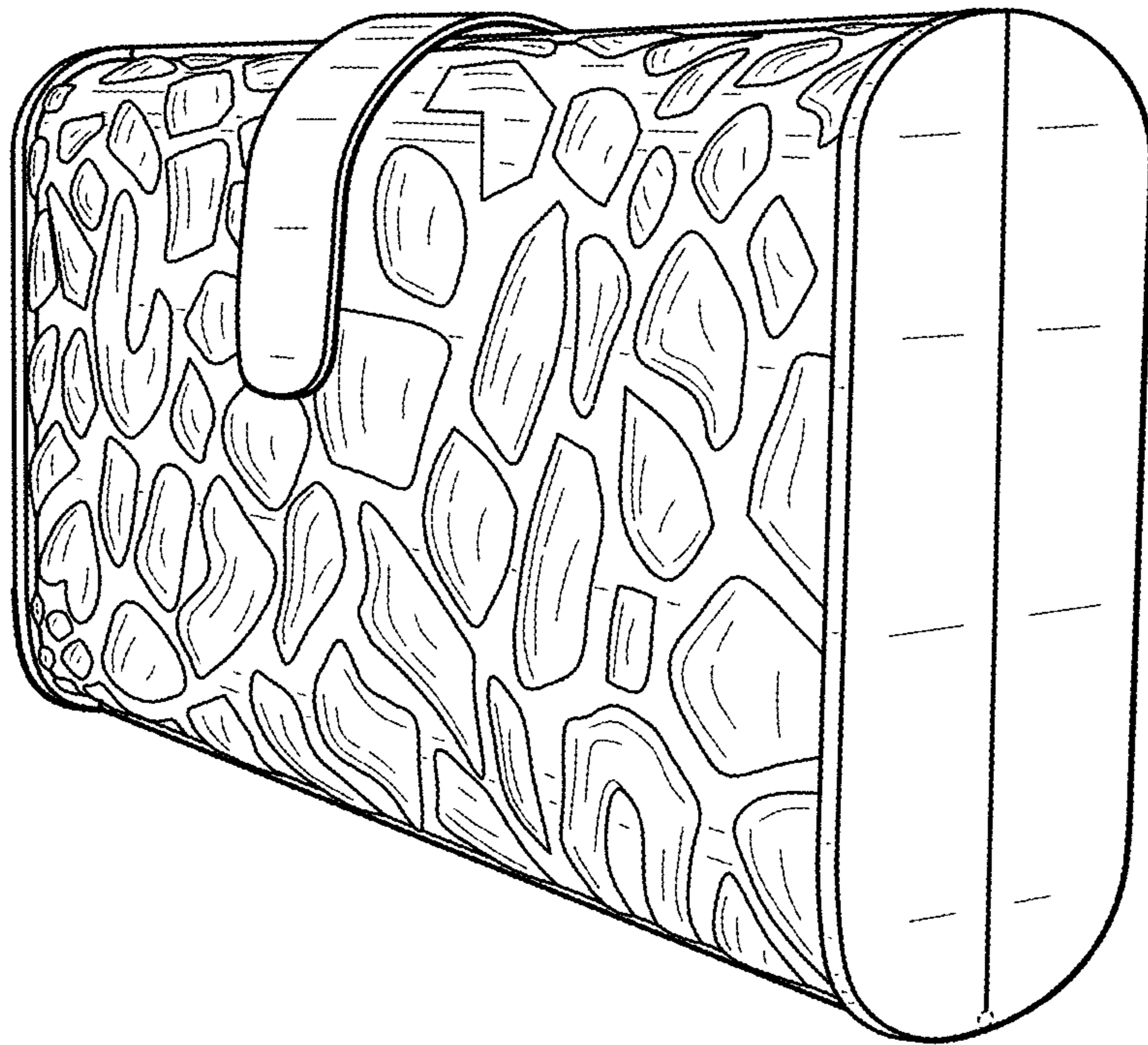

FIG. 2

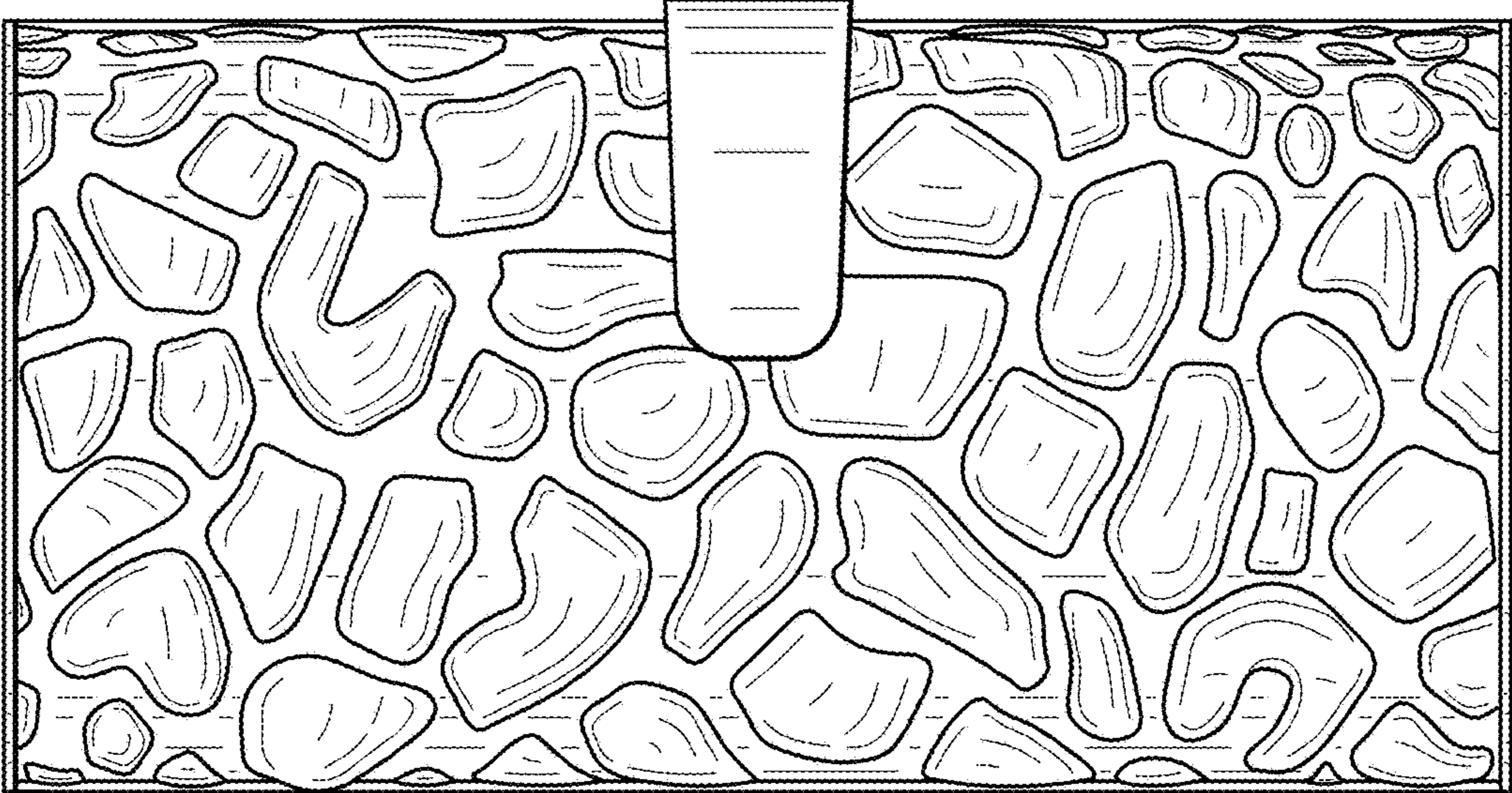

FIG. 3

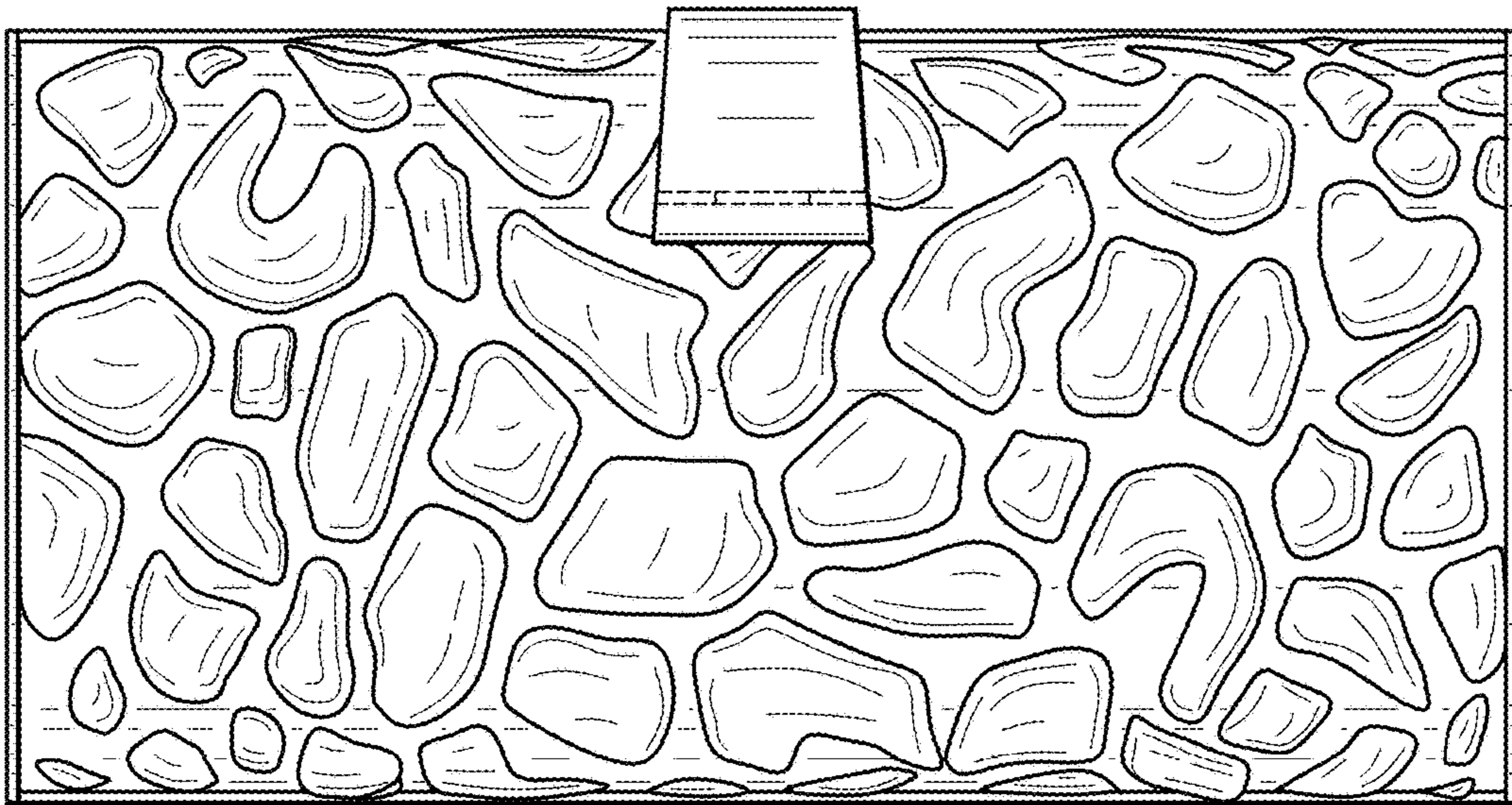

FIG. 4

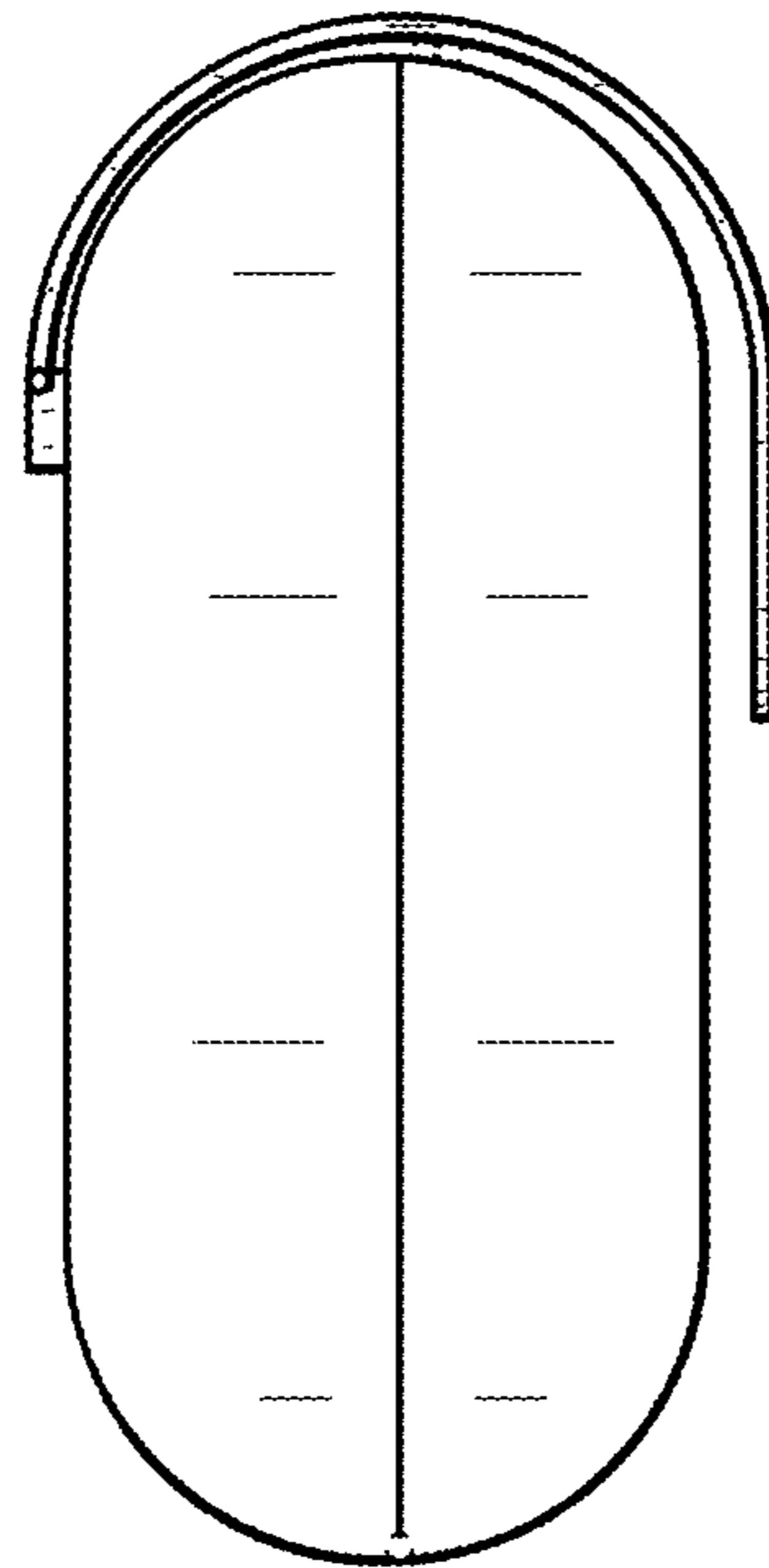

FIG. 5

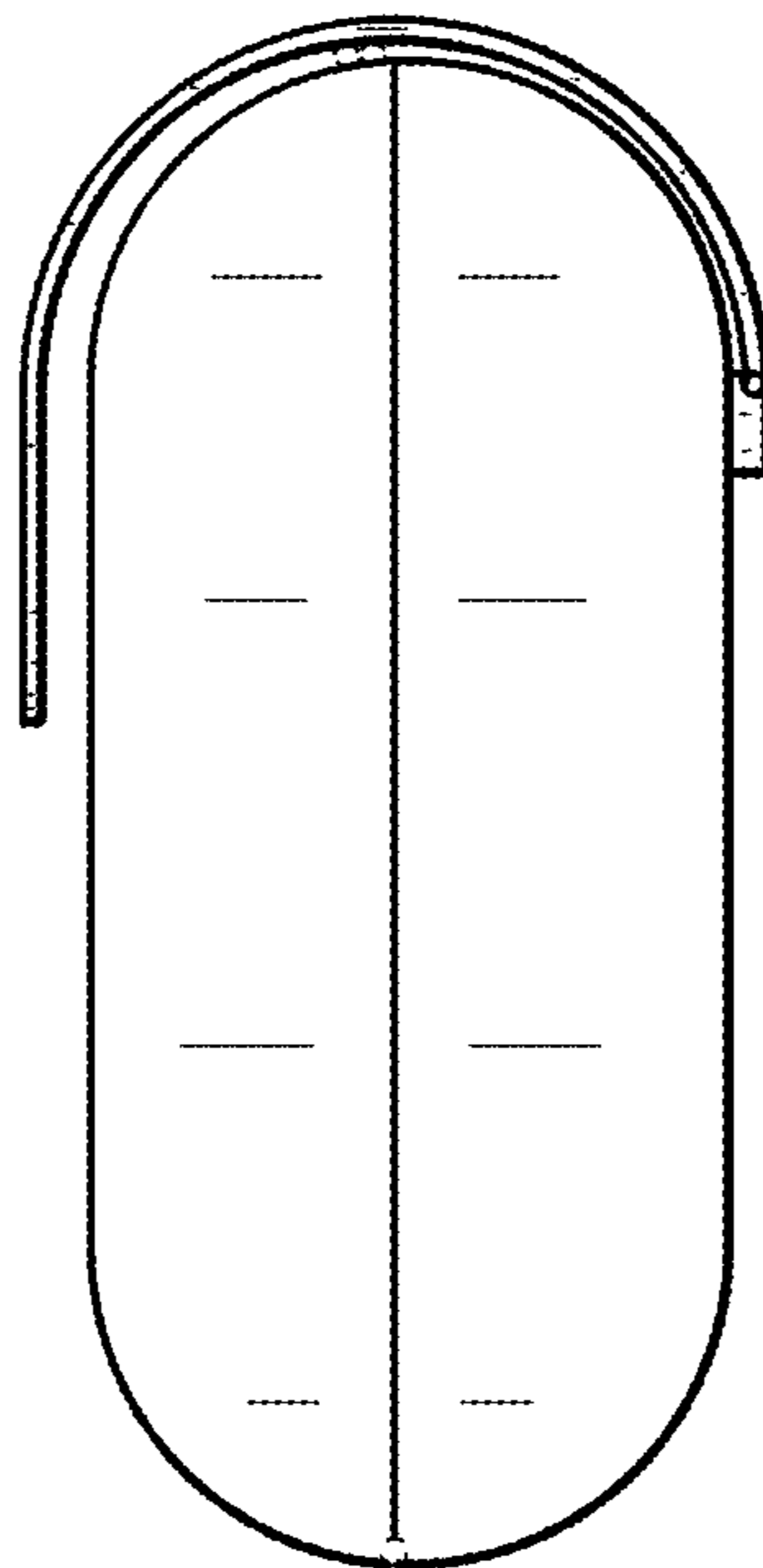

FIG. 6

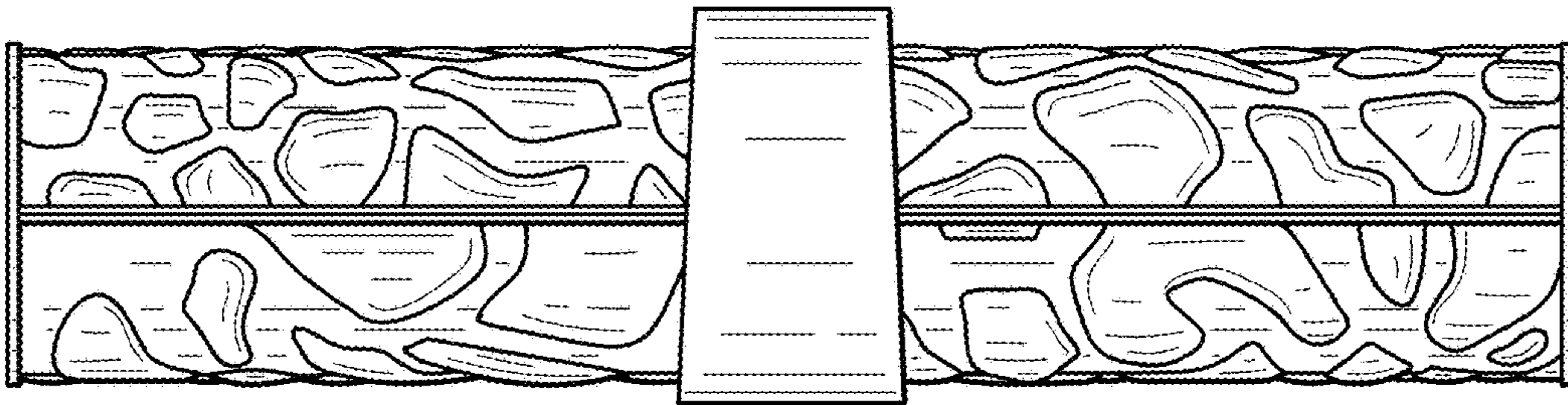

FIG. 7

