



US00D778409S

(12) **United States Design Patent** (10) **Patent No.:** **US D778,409 S**  
**Hanna et al.** (45) **Date of Patent:** **\*\* Feb. 7, 2017**

- (54) **FAUCET HANDLE**
- (71) Applicant: **Kohler Co.**, Kohler, WI (US)
- (72) Inventors: **Ken S. Hanna**, Bellingham, WA (US);  
**Margaret C. Mazz**, Sheboygan, WI (US); **Gary N. Clarke**, Sheboygan, WI (US)
- (73) Assignee: **KOHLER CO.**, Kohler, WI (US)
- (\*\*) Term: **15 Years**
- (21) Appl. No.: **29/572,373**
- (22) Filed: **Jul. 27, 2016**

- D407,466 S 3/1999 Hundley et al.
- D413,654 S 9/1999 Paredes et al.
- D573,696 S 7/2008 Eilmus
- D578,618 S 10/2008 Williams
- D579,526 S 10/2008 Williams
- D585,112 S 1/2009 Kohler et al.
- D686,705 S 7/2013 Fritz
- D703,789 S 4/2014 Mazz et al.
- D709,167 S 7/2014 Flowers et al.
- D714,916 S 10/2014 Flowers et al.
- 8,899,259 B2 12/2014 Jonte et al.
- D723,661 S 3/2015 Zhang

*Primary Examiner* — Robert Delehanty  
(74) *Attorney, Agent, or Firm* — Foley & Lardner LLP

**Related U.S. Application Data**

- (62) Division of application No. 29/567,913, filed on Jun. 14, 2016, which is a division of application No. 29/535,168, filed on Aug. 4, 2015, now Pat. No. Des. 761,392, which is a division of application No. 29/500,416, filed on Aug. 25, 2014, now Pat. No. Des. 746,412.
- (51) **LOC (10) Cl.** ..... **23-01**
- (52) **U.S. Cl.**  
USPC ..... **D23/252**
- (58) **Field of Classification Search**  
USPC ..... D23/238, 249, 250, 252, 255, 257  
CPC ..... E03C 1/04; E03C 1/0401; E03C 1/0402;  
E03C 1/0404; E03C 2001/0415  
See application file for complete search history.

**References Cited**

**U.S. PATENT DOCUMENTS**

- D364,213 S 11/1995 Dannenberg et al.
- D400,651 S 11/1998 Hundley et al.

(57) **CLAIM**

We claim the ornamental design for a faucet handle, as shown and described.

**DESCRIPTION**

FIG. 1 is a perspective view of an embodiment of the claimed design;  
FIG. 2 is a front view thereof;  
FIG. 3 is a rear view thereof;  
FIG. 4 is a left side view thereof;  
FIG. 5 is a right side view thereof;  
FIG. 6 is a top view thereof; and,  
FIG. 7 is a bottom view thereof.  
The ornamental design which is claimed is shown in solid lines in the drawings. The broken lines in the drawings are for purposes of illustrating unclaimed portions of the design. Broken lines formed by equal length dashes show unclaimed portions of the design.

**1 Claim, 7 Drawing Sheets**

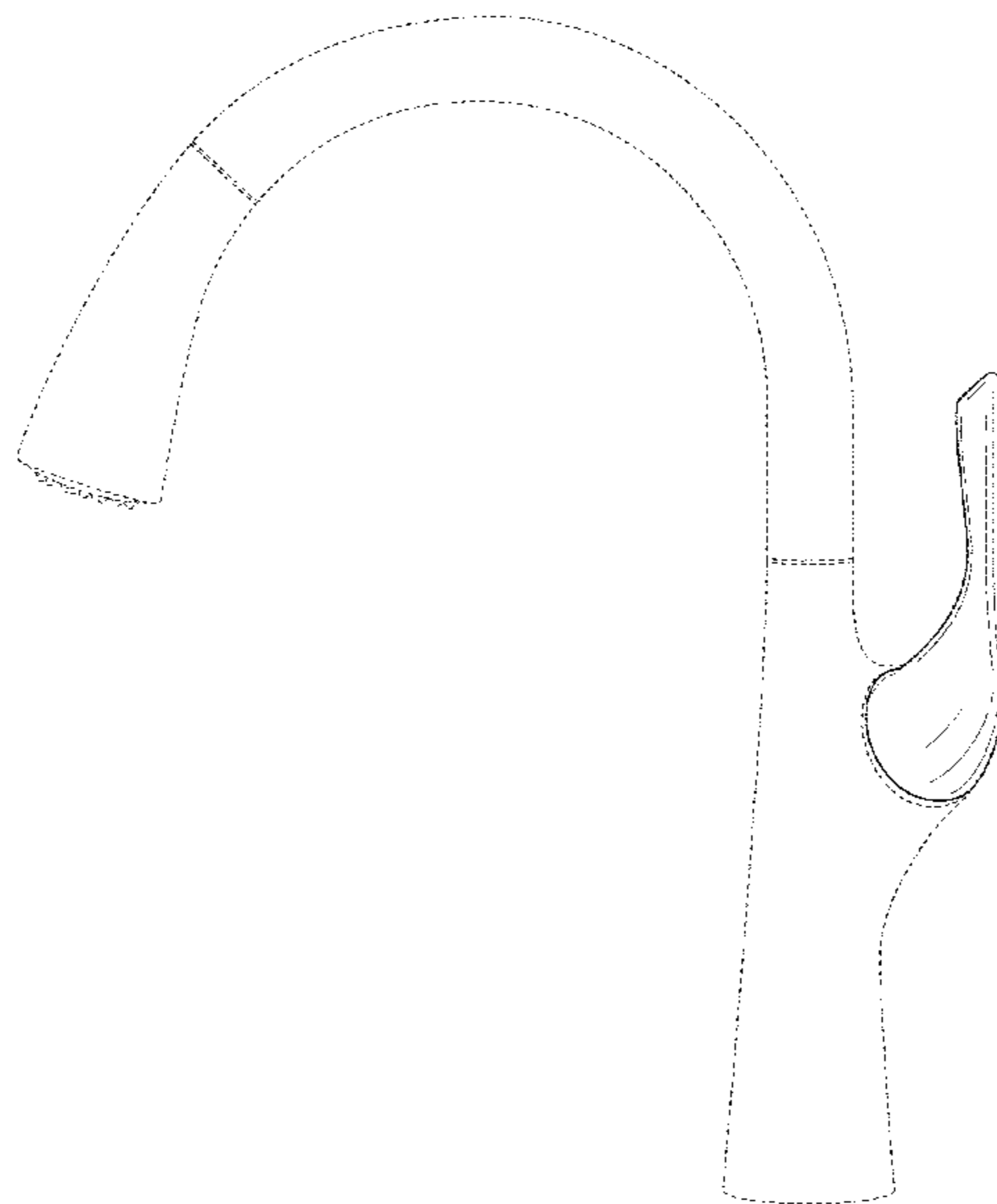

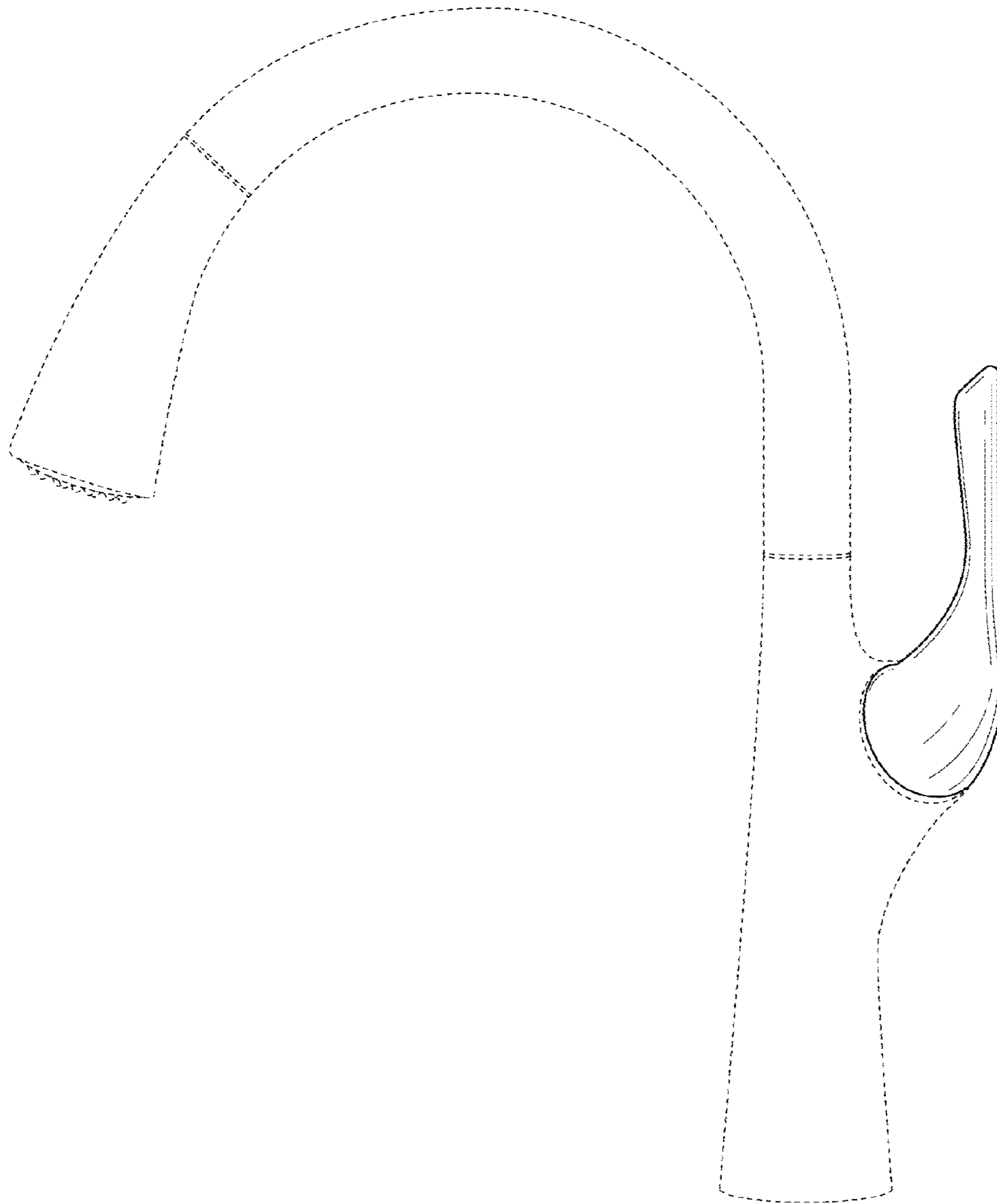

FIG. 1

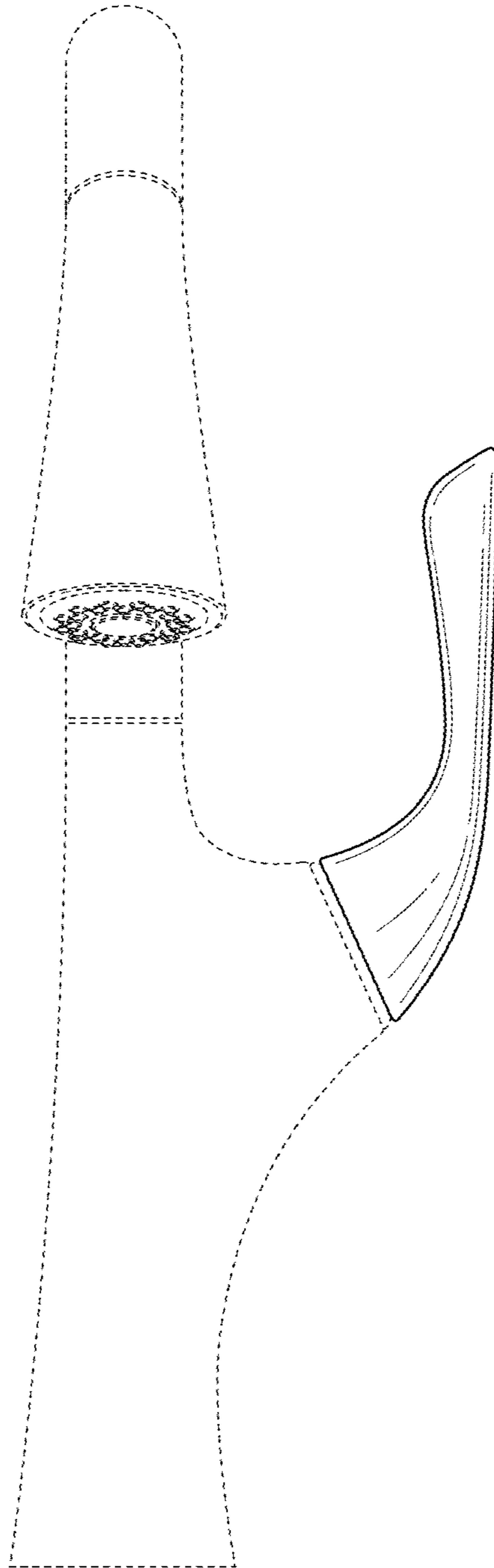
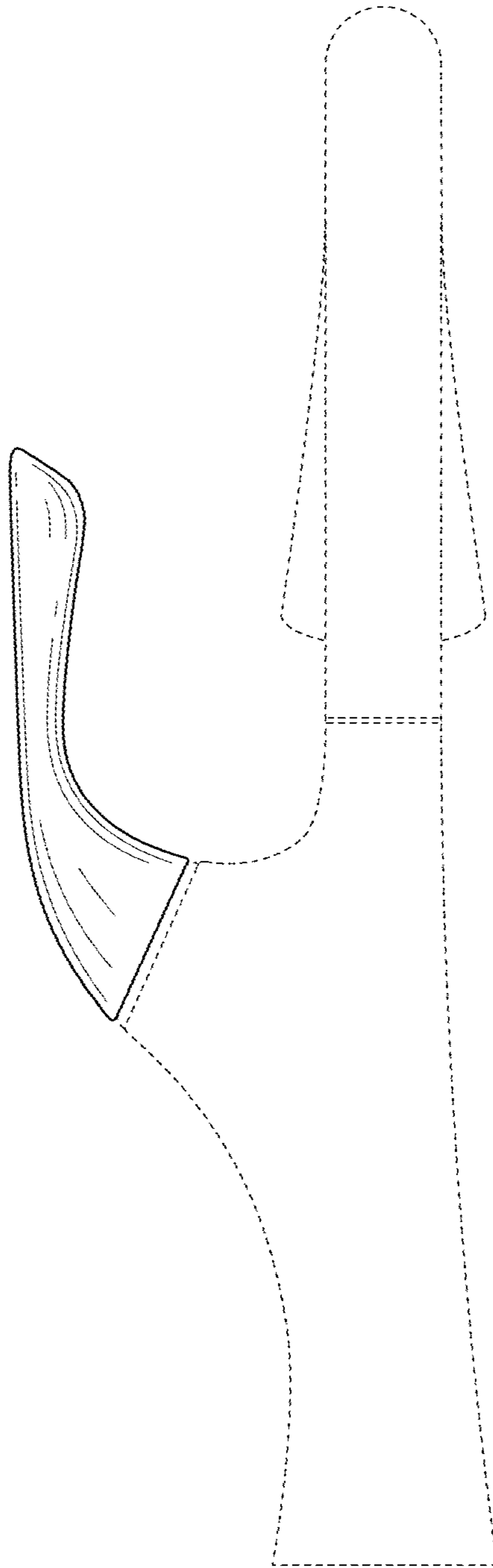

FIG. 2



**FIG. 3**

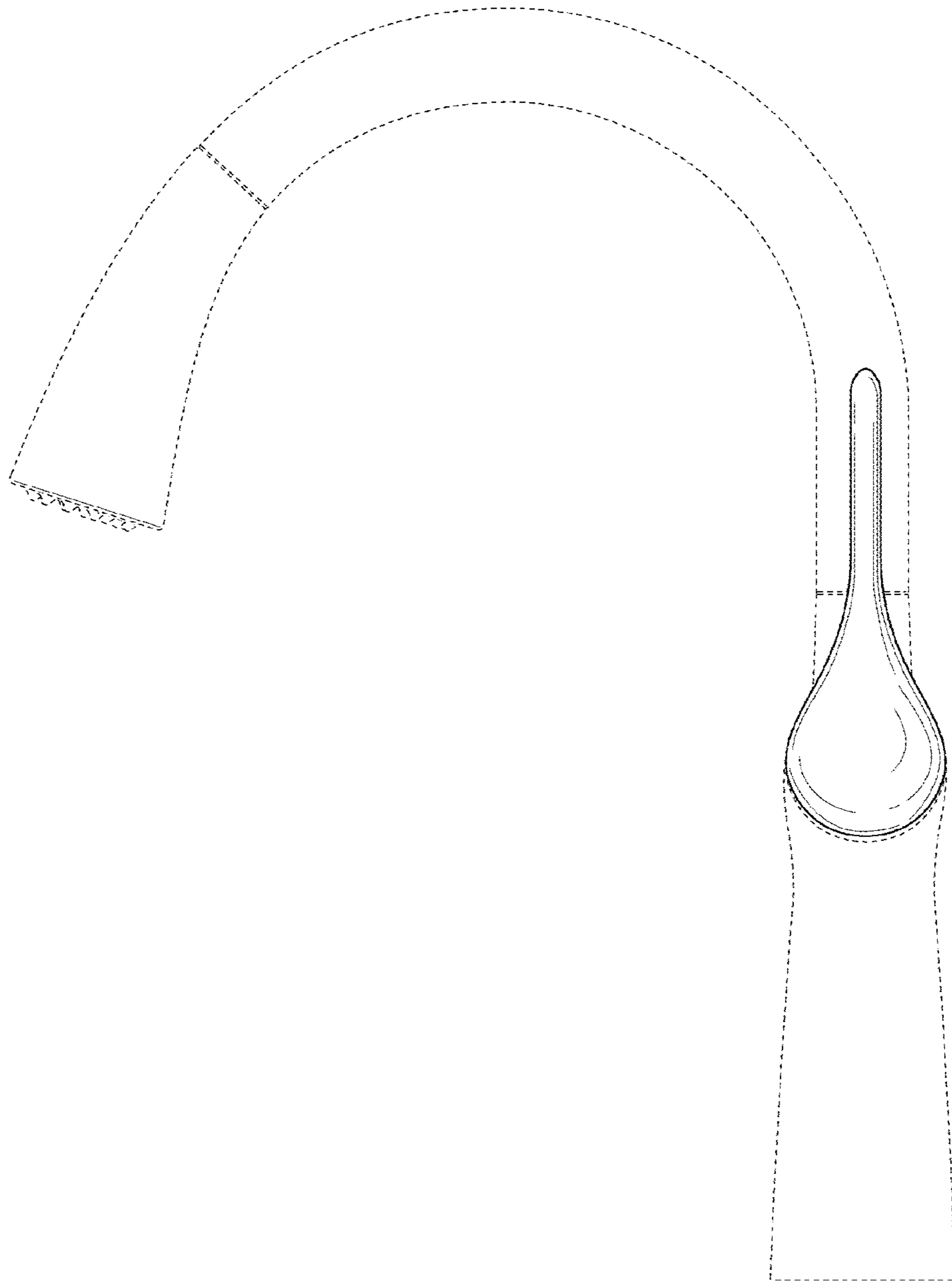

FIG. 4

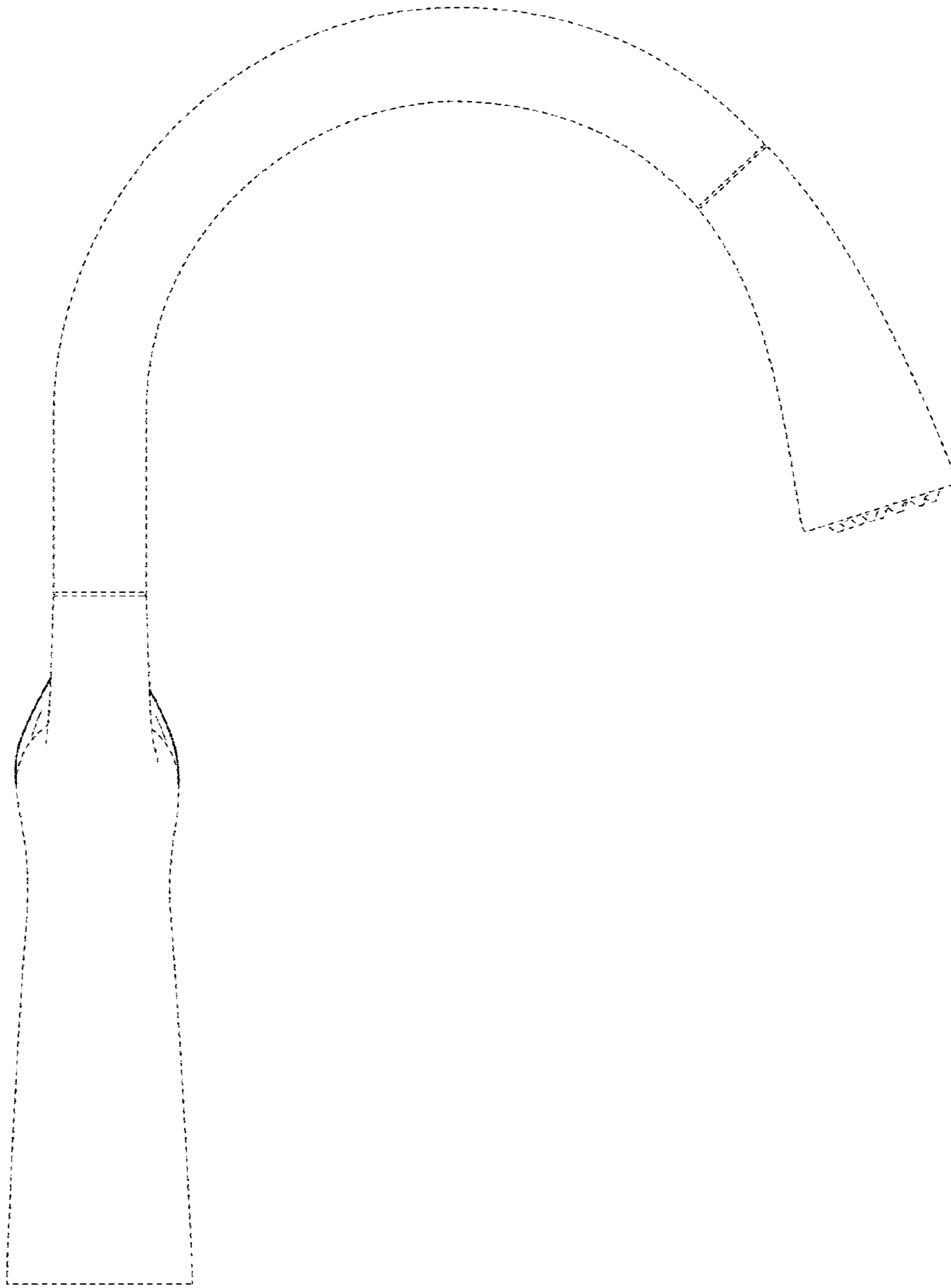

FIG. 5

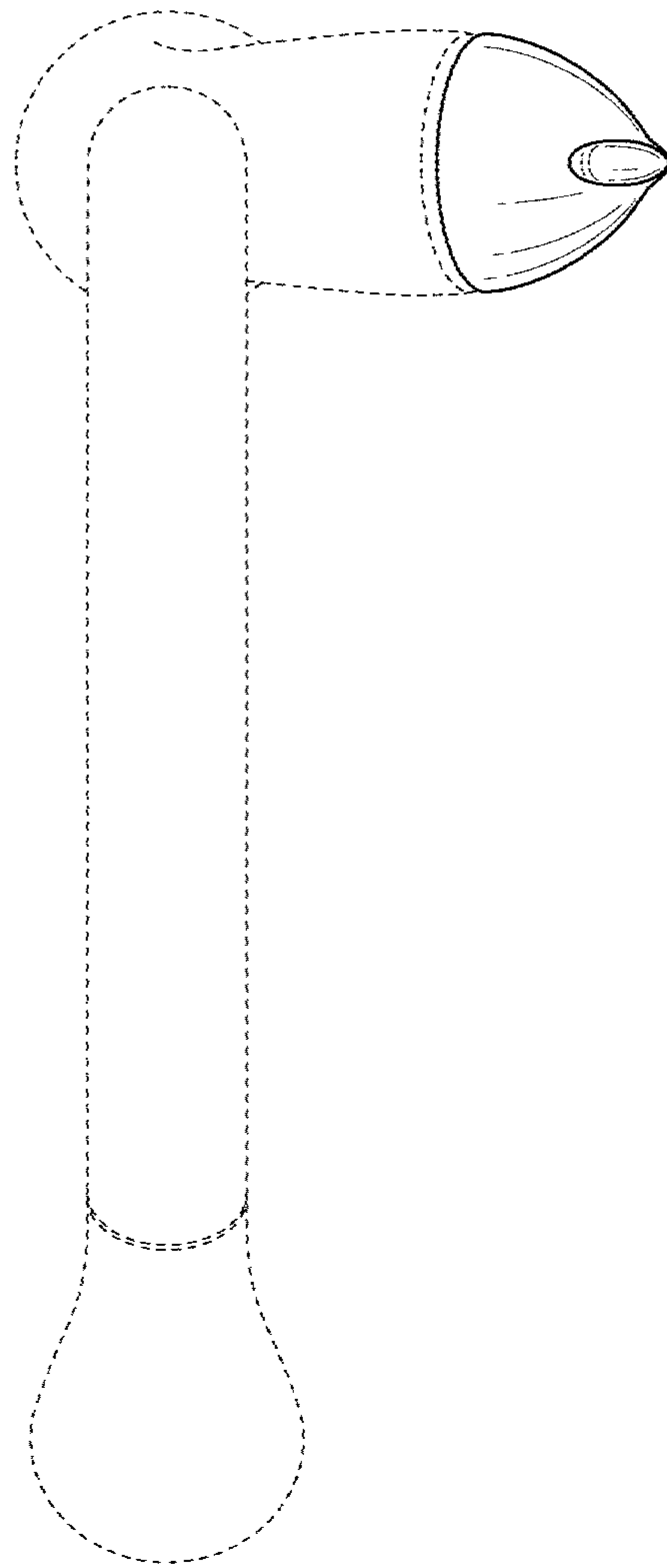
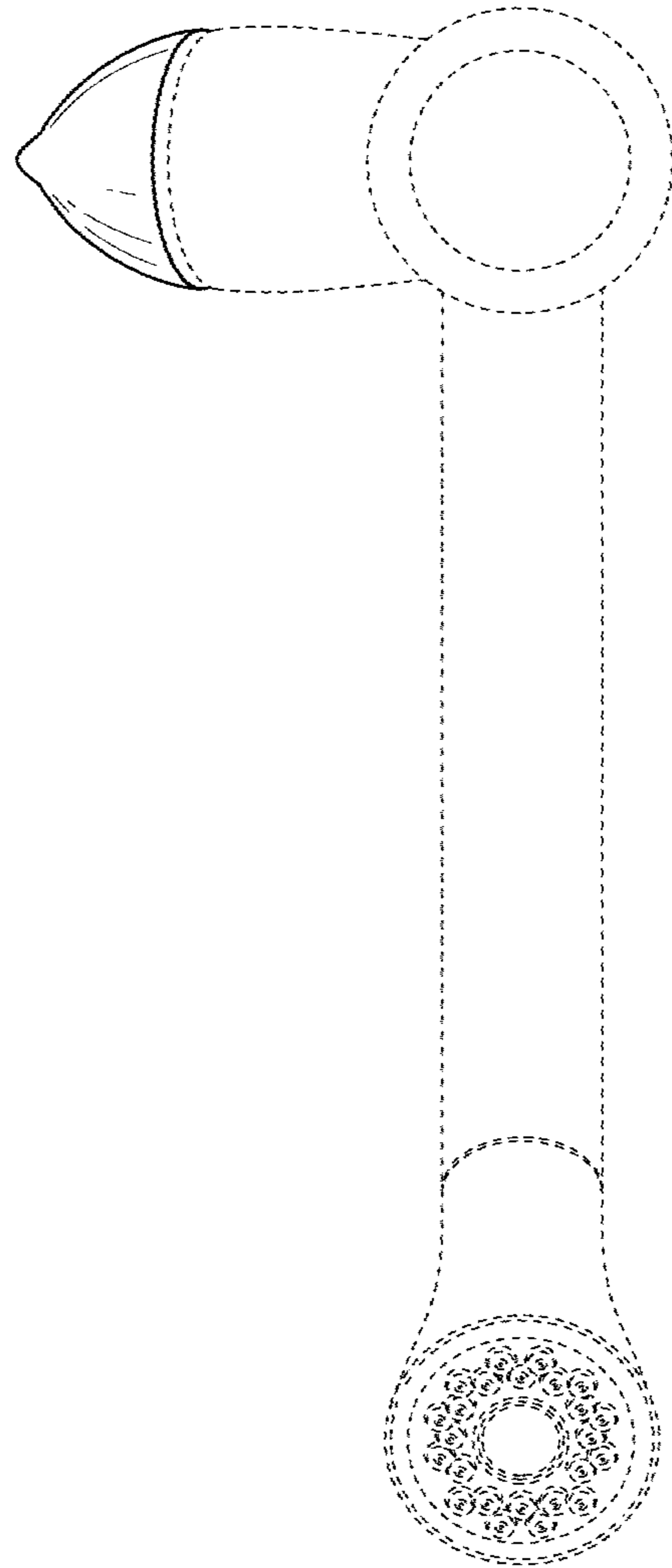

FIG. 6



**FIG. 7**