



US00D778261S

(12) **United States Design Patent**  
**Ito et al.**

(10) **Patent No.:** **US D778,261 S**

(45) **Date of Patent:** **\*\* Feb. 7, 2017**

(54) **DIGITAL MIXER**

(71) Applicant: **YAMAHA CORPORATION**,  
Hamamatsu-shi, Shizuoka (JP)

(72) Inventors: **Masafumi Ito**, Hamamatsu (JP);  
**Takashi Honda**, Nagoya (JP)

(73) Assignee: **YAMAHA CORPORATION**,  
Hamamatsu-shi (JP)

(\*\*) Term: **14 Years**

(21) Appl. No.: **29/511,524**

(22) Filed: **Dec. 11, 2014**

(51) **LOC (10) Cl.** ..... **14-03**

(52) **U.S. Cl.**  
USPC ..... **D14/217**

(58) **Field of Classification Search**  
USPC ..... D14/217, 257, 258, 434, 496, 162, 167,  
D14/175, 188, 196-198  
CPC .... G06F 1/1626; G06F 1/1688; G10L 19/008;  
G10L 19/167; H03G 3/00; H03G  
3/04; H03G 3/3005; H03G 3/3089; H03G  
5/00; H03G 5/005; H03G 5/025; H03G  
9/18; G11B 19/02; G11B  
20/10527; G11B 27/00; G11B  
27/34; G11B 27/031; G11B 27/034;  
G11B 27/038; G11B 27/105; G11B  
33/025; H04R 3/00; H04R 3/005; H04R  
5/04; H04R 2205/021; H04R 2499/11  
See application file for complete search history.

(56) **References Cited**

**U.S. PATENT DOCUMENTS**

D588,580 S \* 3/2009 Chisholm ..... D14/217  
D607,438 S \* 1/2010 Ito ..... D14/217  
D616,866 S \* 6/2010 Ito ..... D14/217

D643,411 S \* 8/2011 Siegrist ..... D14/217  
D666,159 S \* 8/2012 Adenau ..... D13/164  
D680,519 S \* 4/2013 Ito ..... D14/217  
D692,414 S \* 10/2013 Ito ..... D14/217

\* cited by examiner

*Primary Examiner* — Ian Simmons

*Assistant Examiner* — Khawaja Anwar

(74) *Attorney, Agent, or Firm* — Sughrue Mion, PLLC

(57) **CLAIM**

The ornamental design for a digital mixer, as shown and described.

**DESCRIPTION**

FIG. 1 is a perspective view of the front, top and right side of a digital mixer according to a first embodiment showing our new design;

FIG. 2 is a front view thereof;

FIG. 3 is a rear view thereof;

FIG. 4 is a left side view thereof;

FIG. 5 is a right side view thereof;

FIG. 6 is a top plan view thereof;

FIG. 7 is a bottom view thereof;

FIG. 8 is a perspective view of the front, top and right side of a digital mixer according to a second embodiment showing our new design;

FIG. 9 is a front view thereof;

FIG. 10 is a rear view thereof;

FIG. 11 is a left side view thereof;

FIG. 12 is a right side view thereof;

FIG. 13 is a top plan view thereof; and,

FIG. 14 is a bottom view thereof.

The broken lines shown are included for the purpose of illustrating the unclaimed portions of a digital mixer and form no part of the claimed design.

The dot and dashed lines mean a boundary between the claimed portion and the non-claimed portion.

**1 Claim, 10 Drawing Sheets**

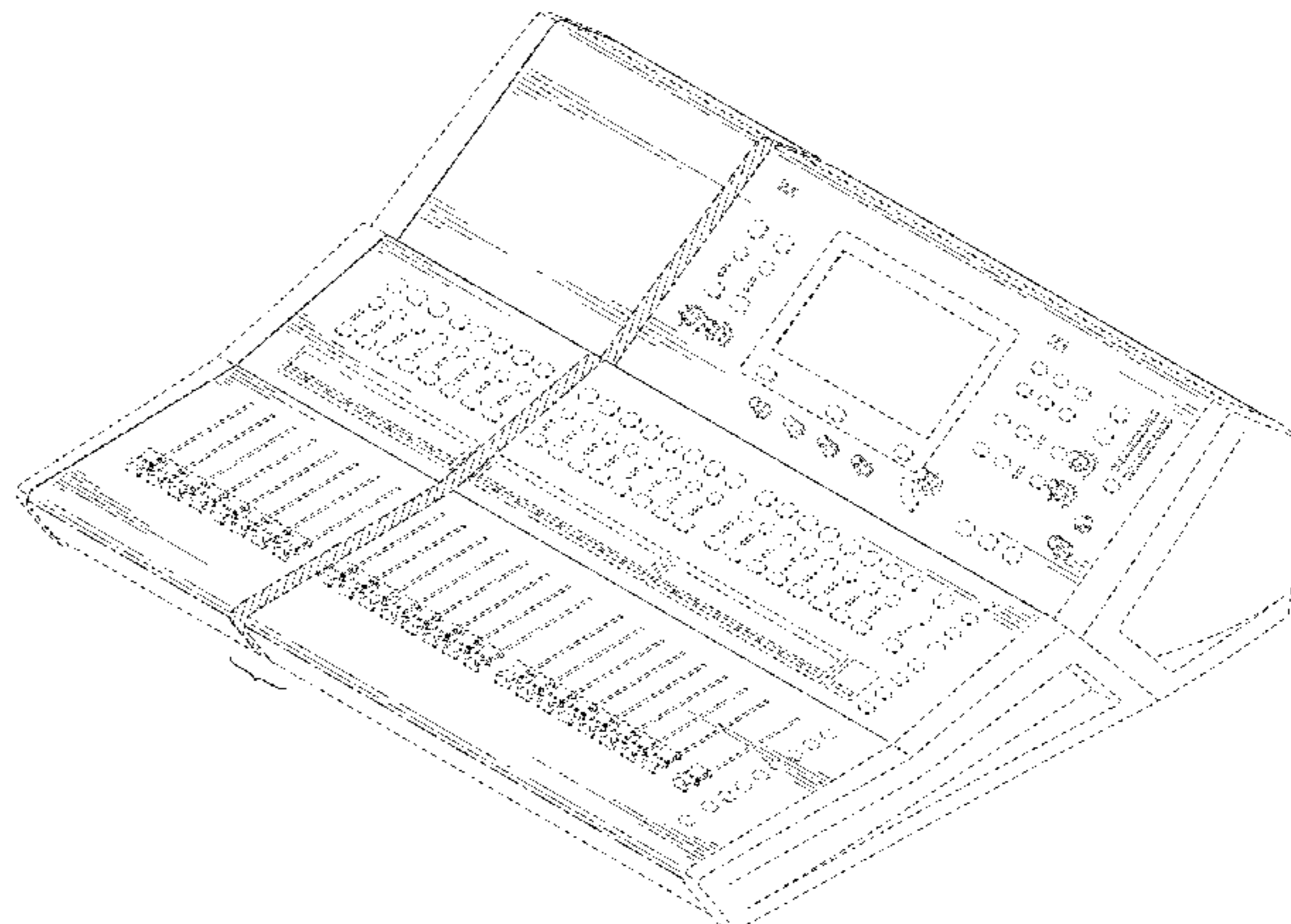
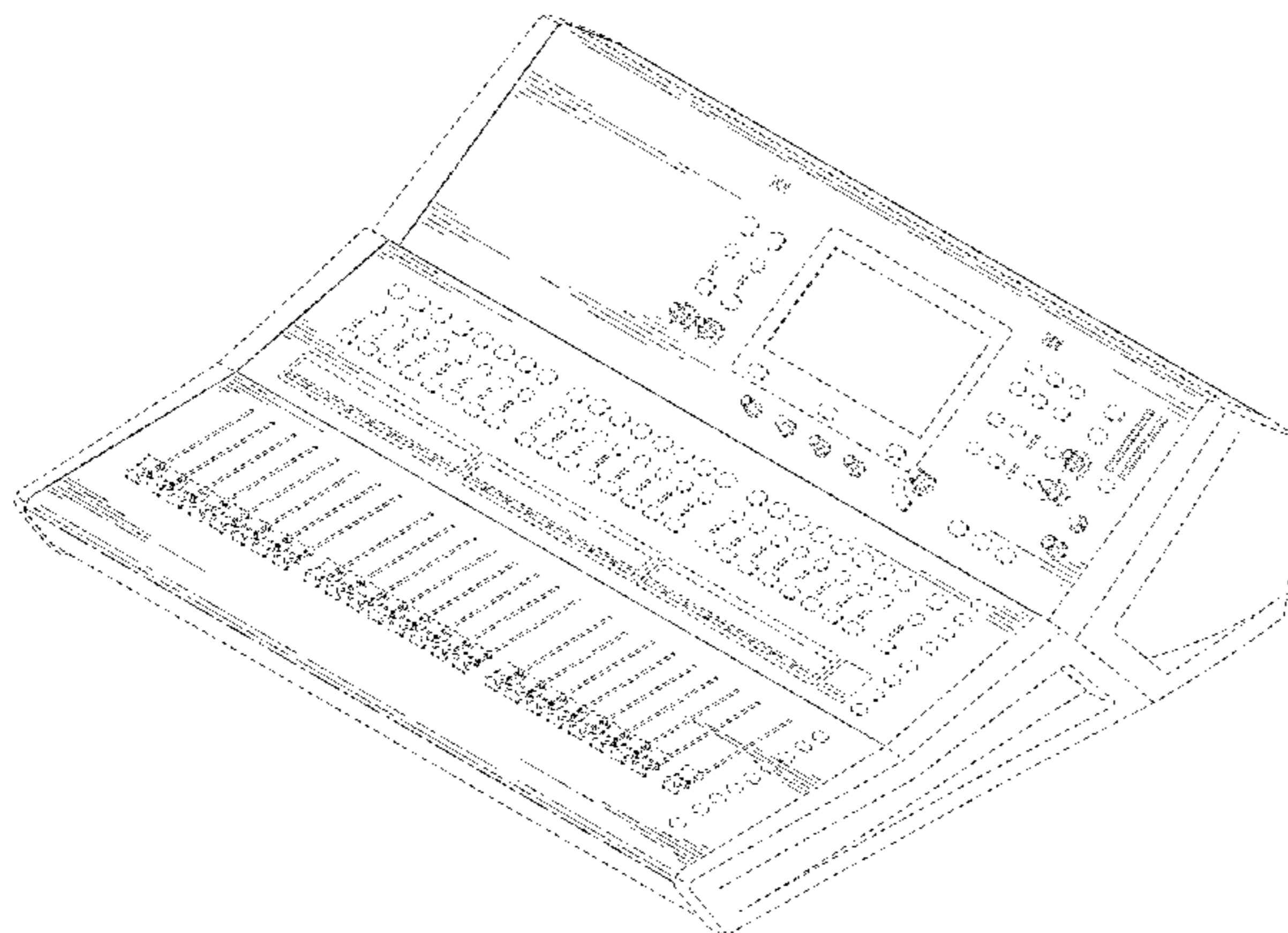

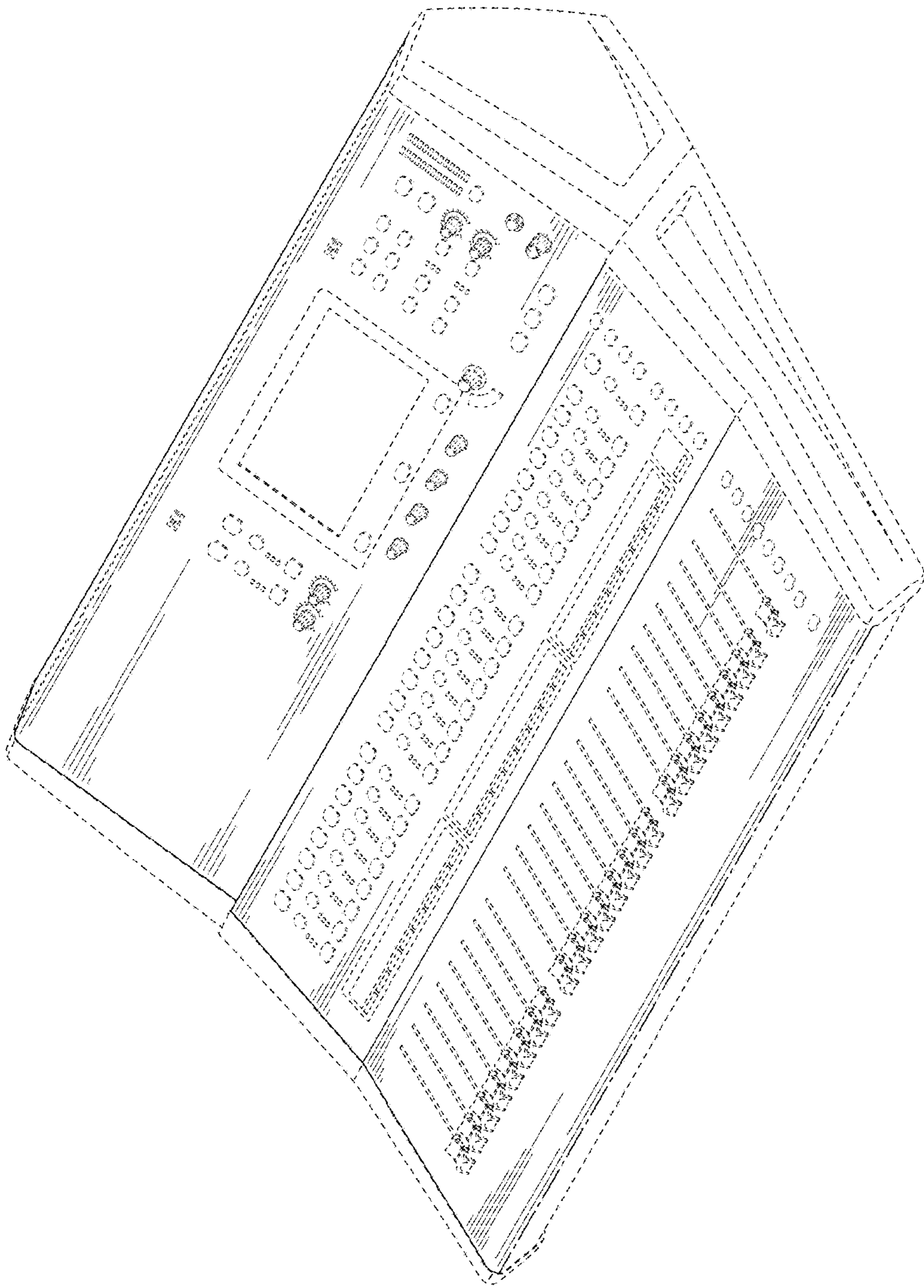

FIG. 1

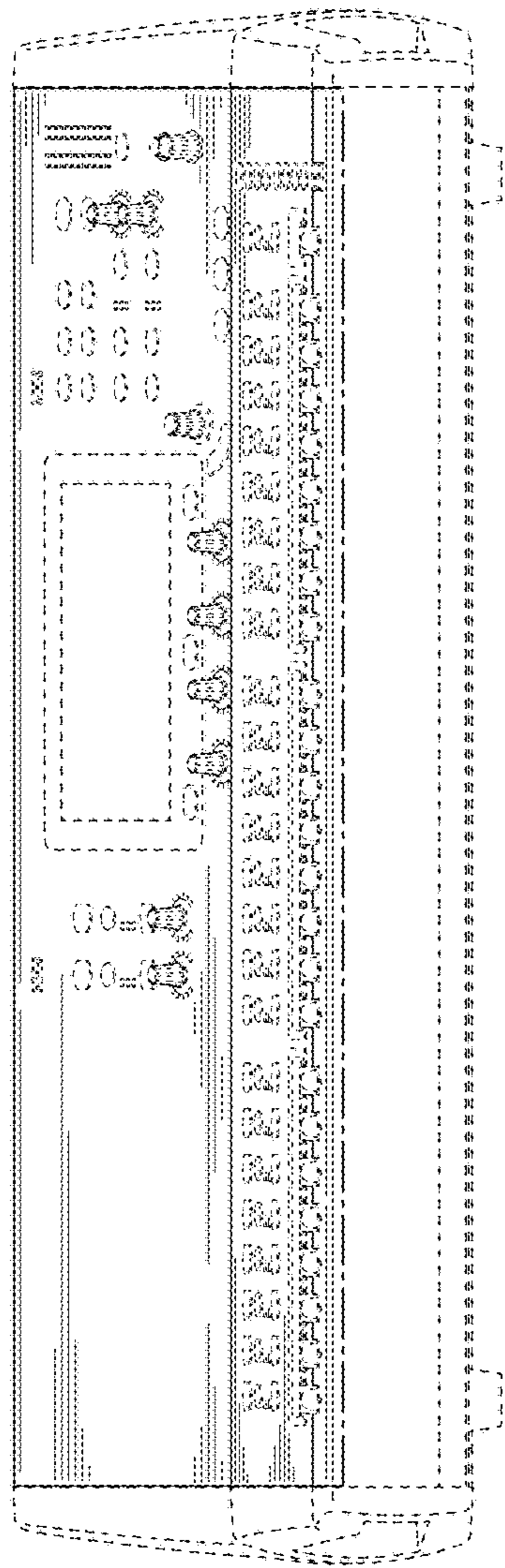

FIG. 2

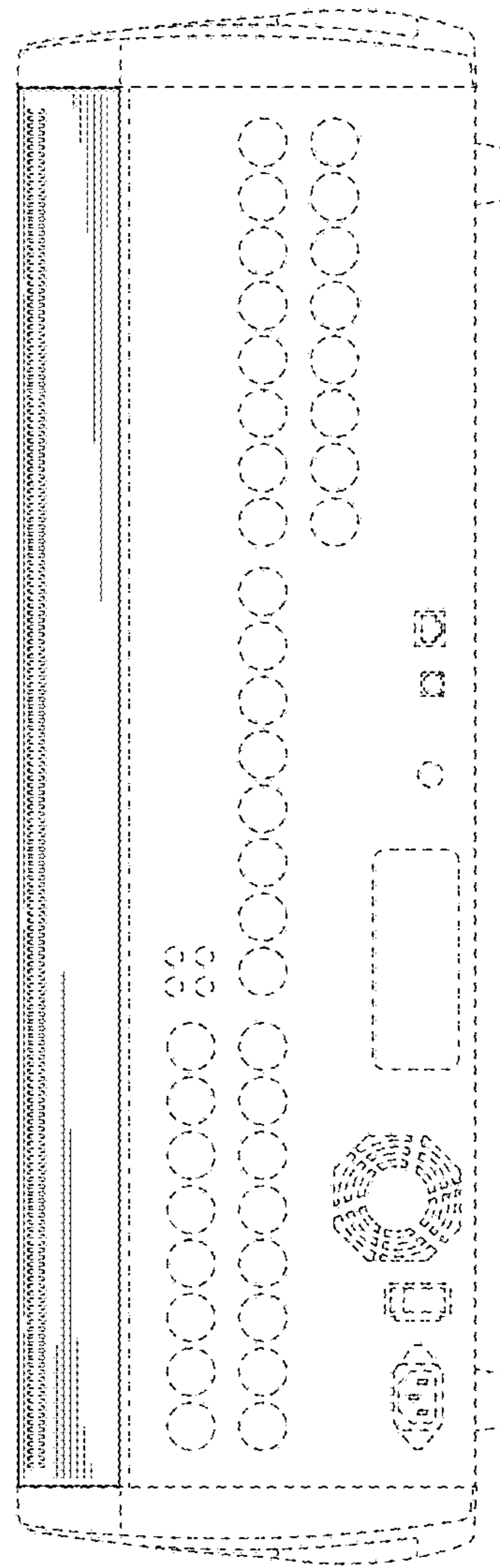

FIG. 3

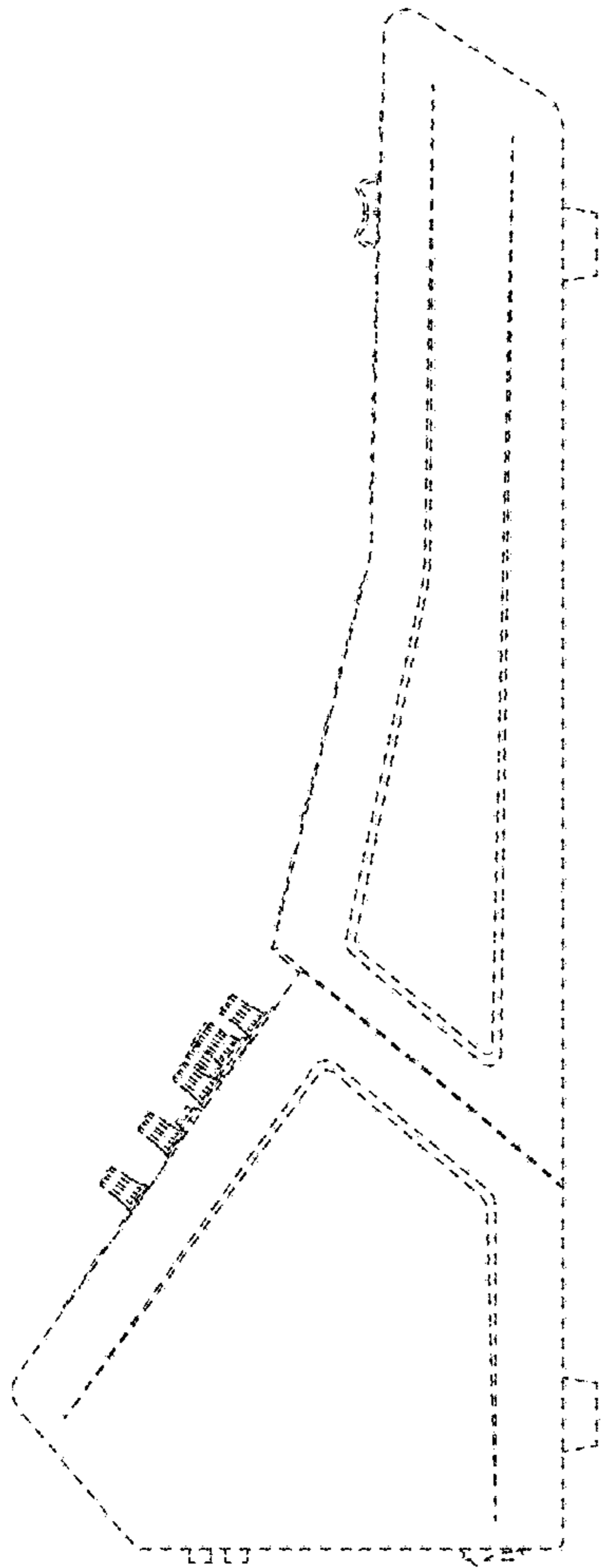

FIG. 4

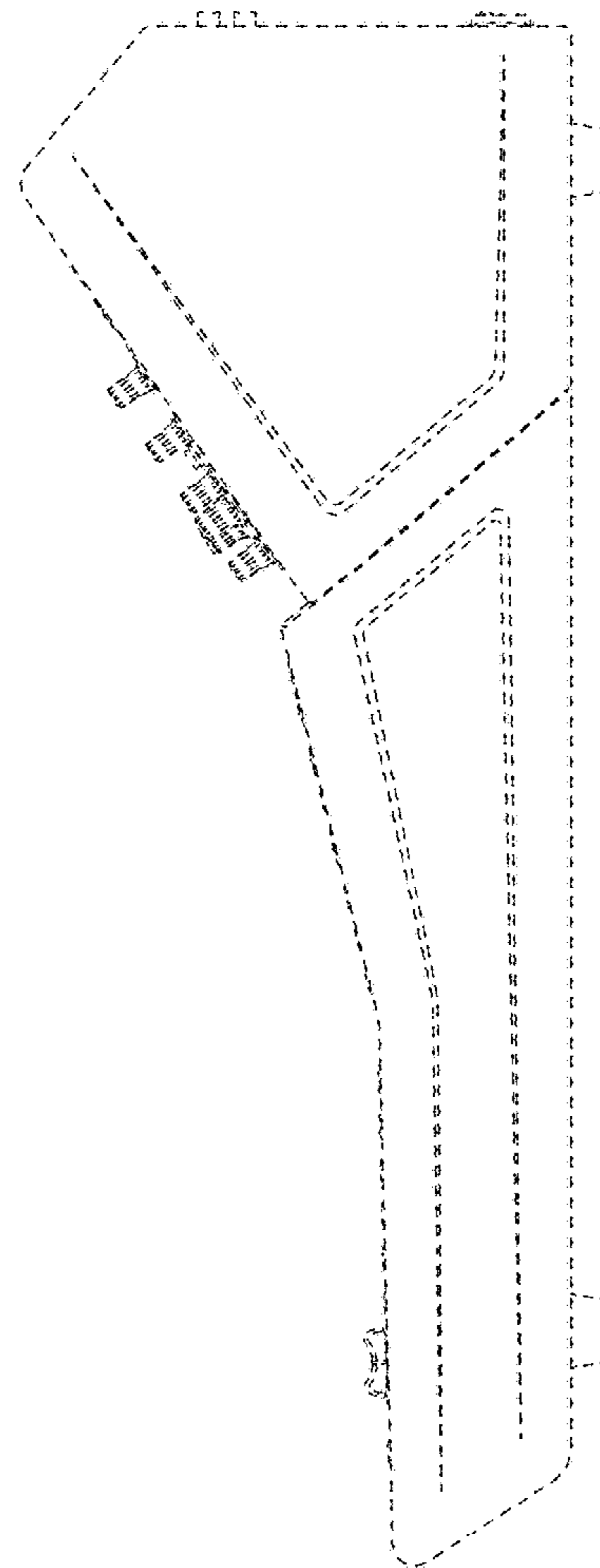

FIG. 5

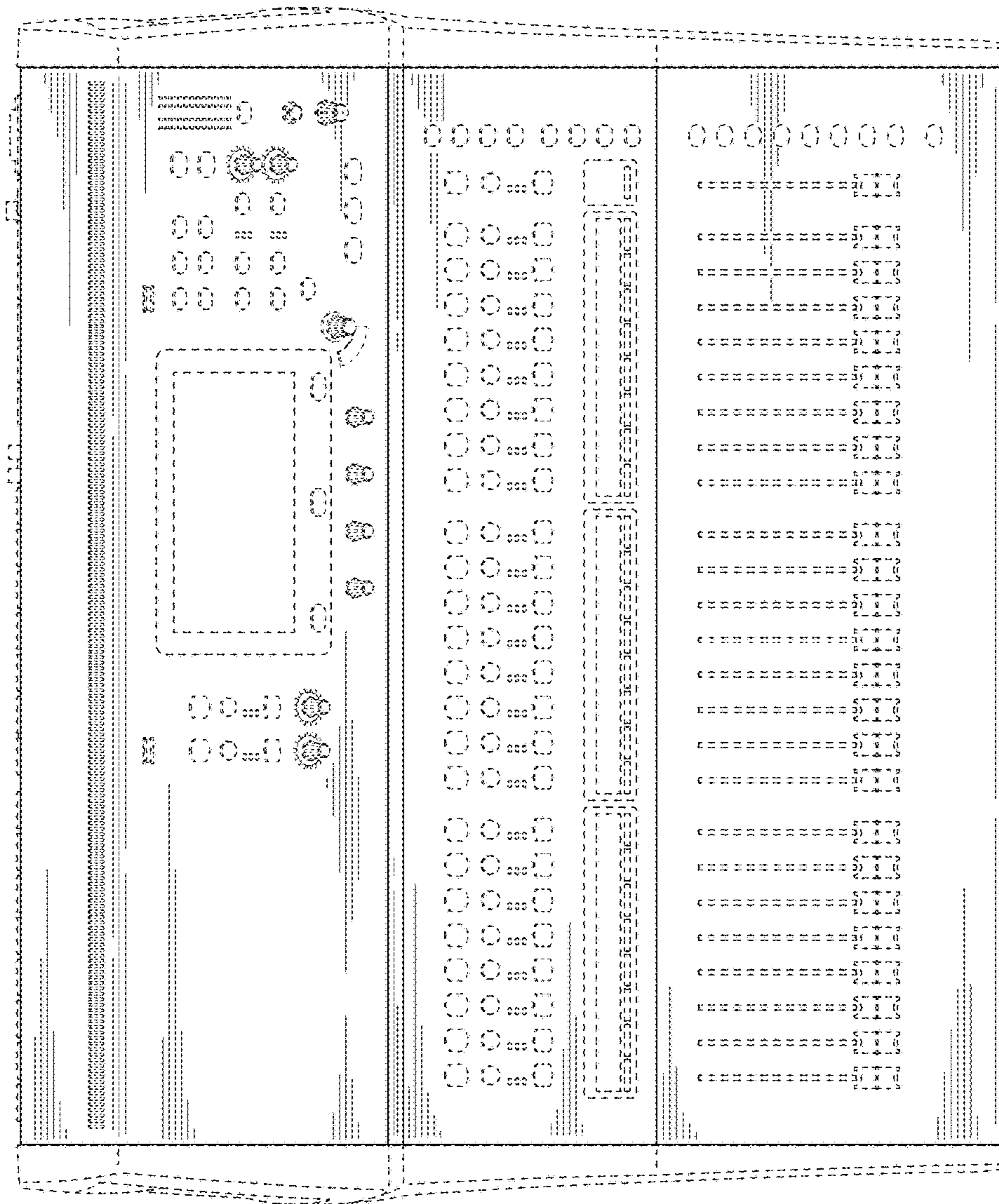

FIG. 6

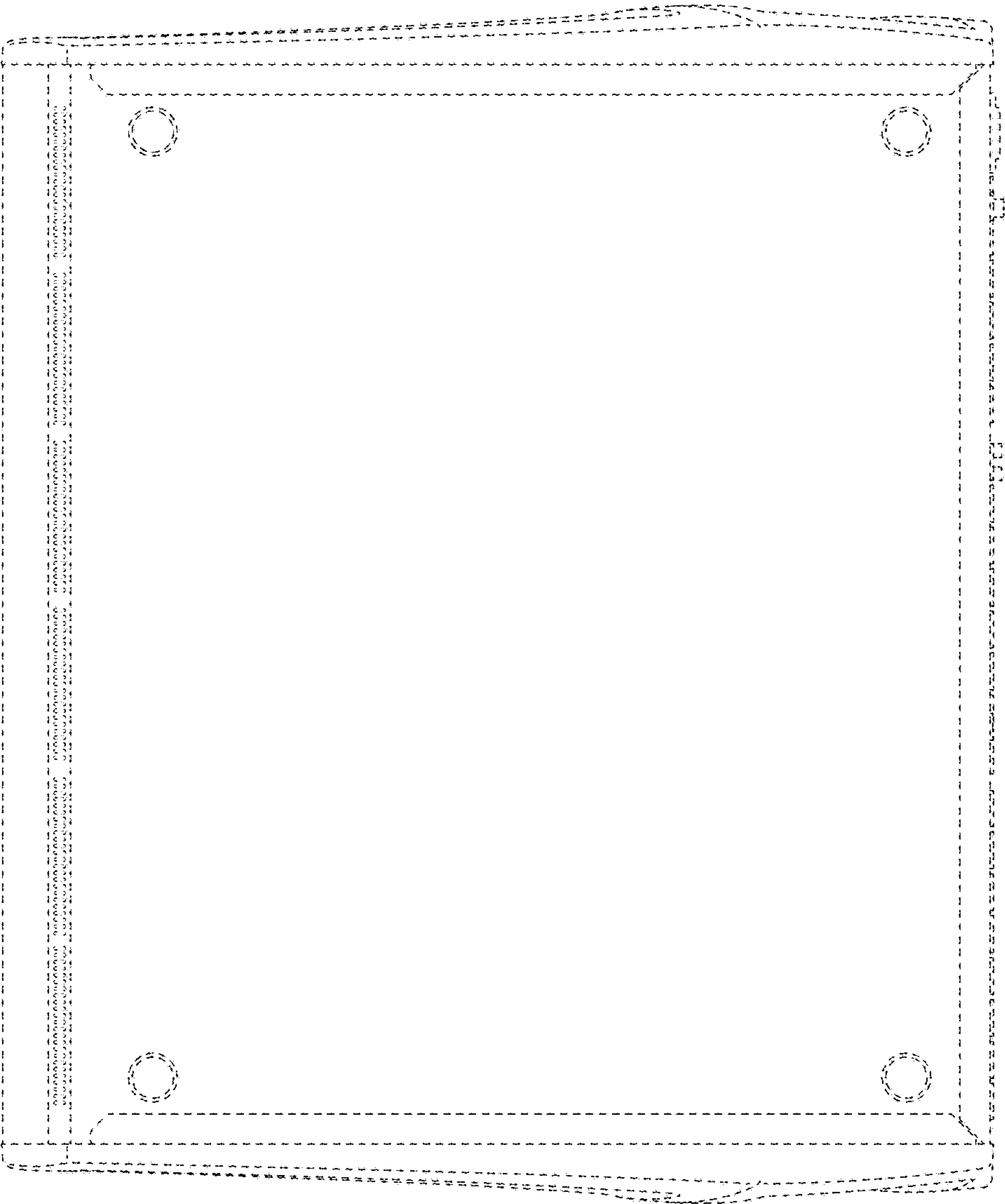

FIG. 7

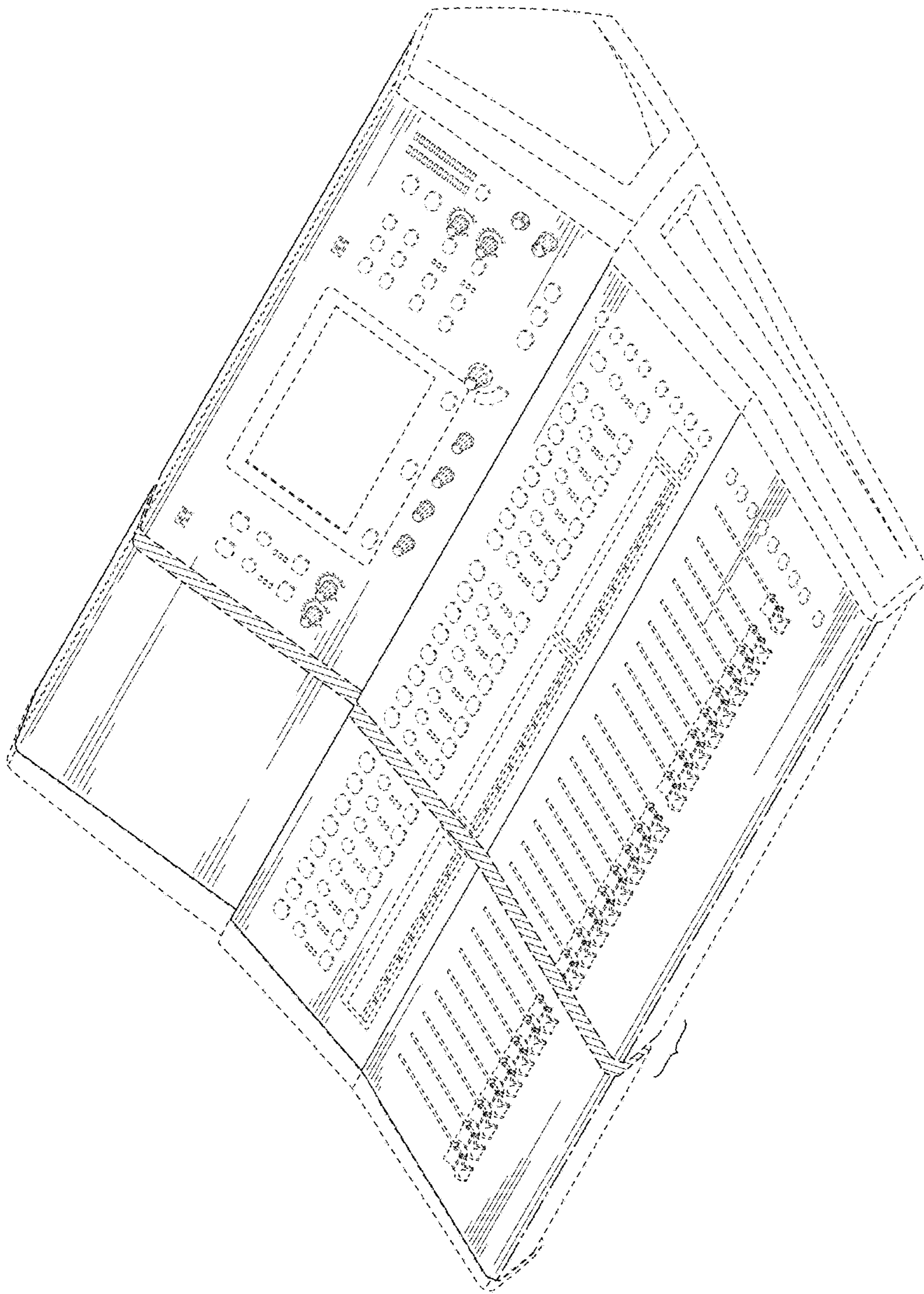

FIG. 8

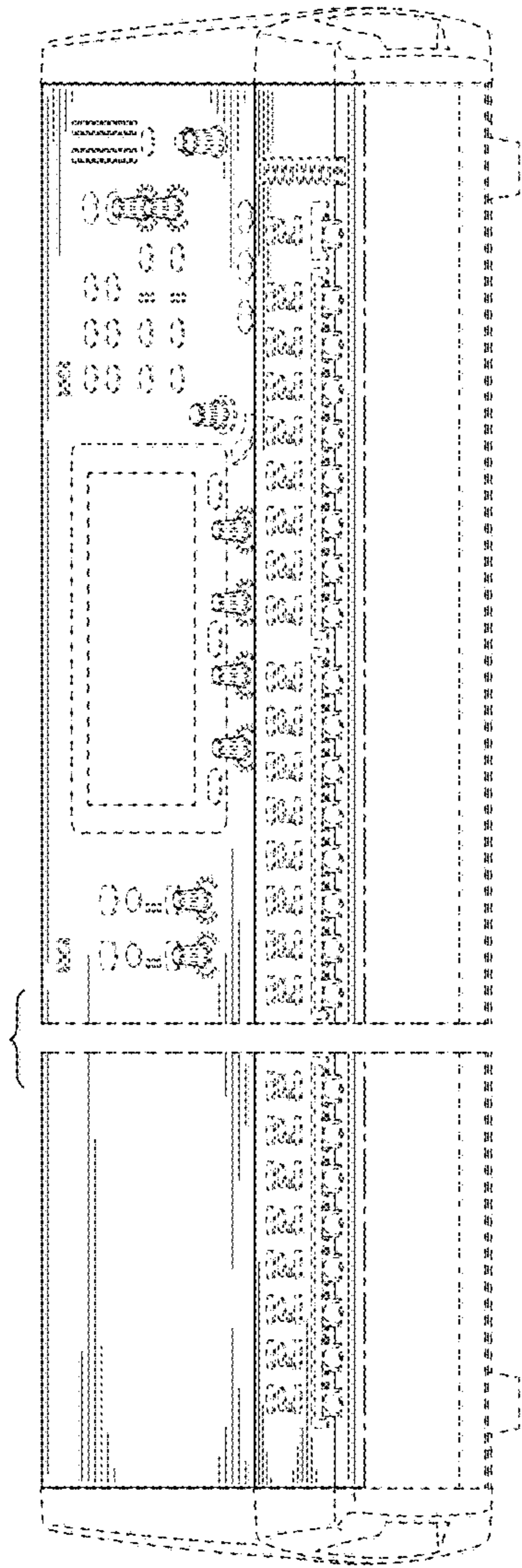

FIG. 9

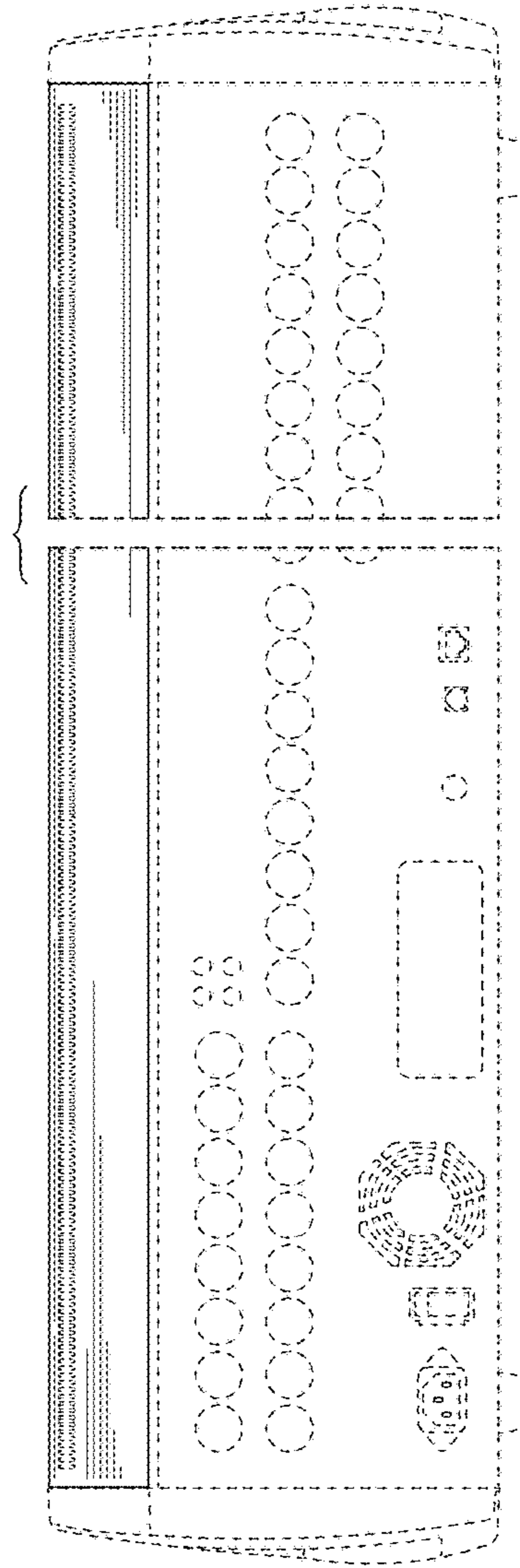

FIG. 10



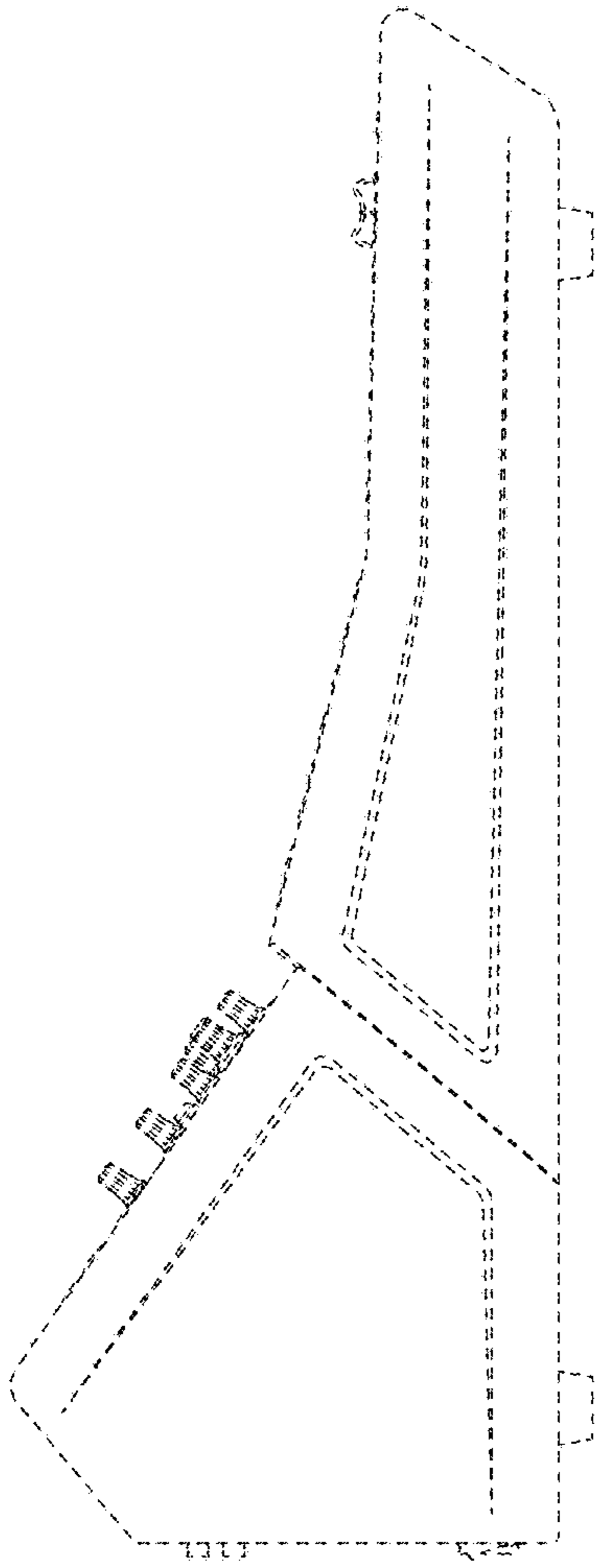

FIG. 11

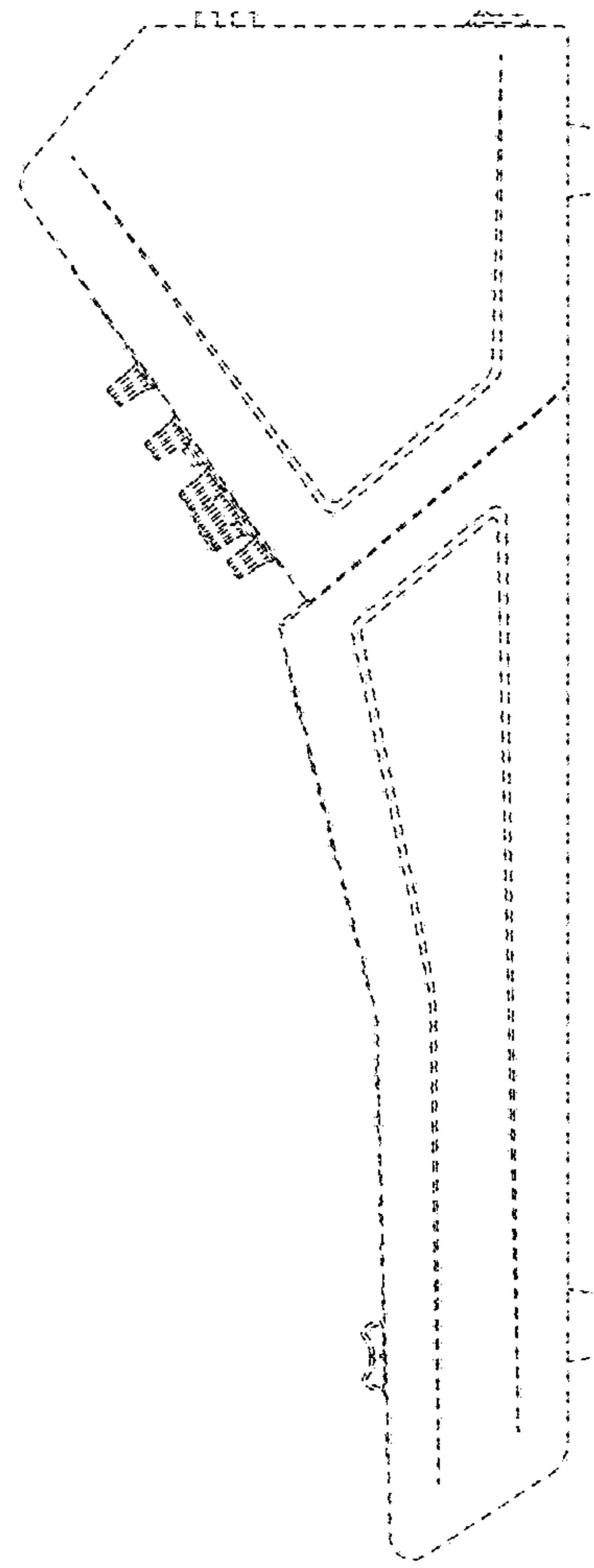

FIG. 12

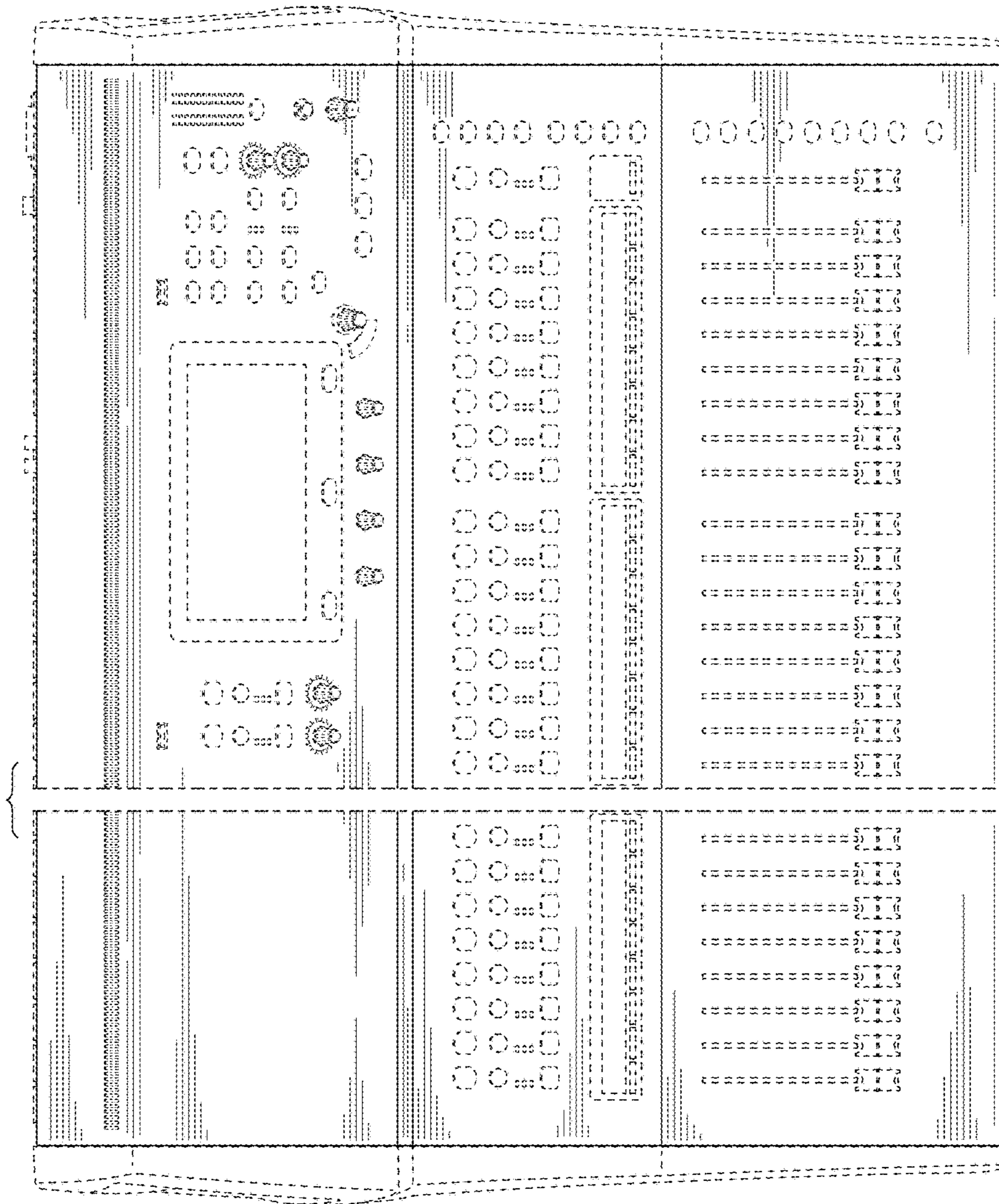

FIG. 13

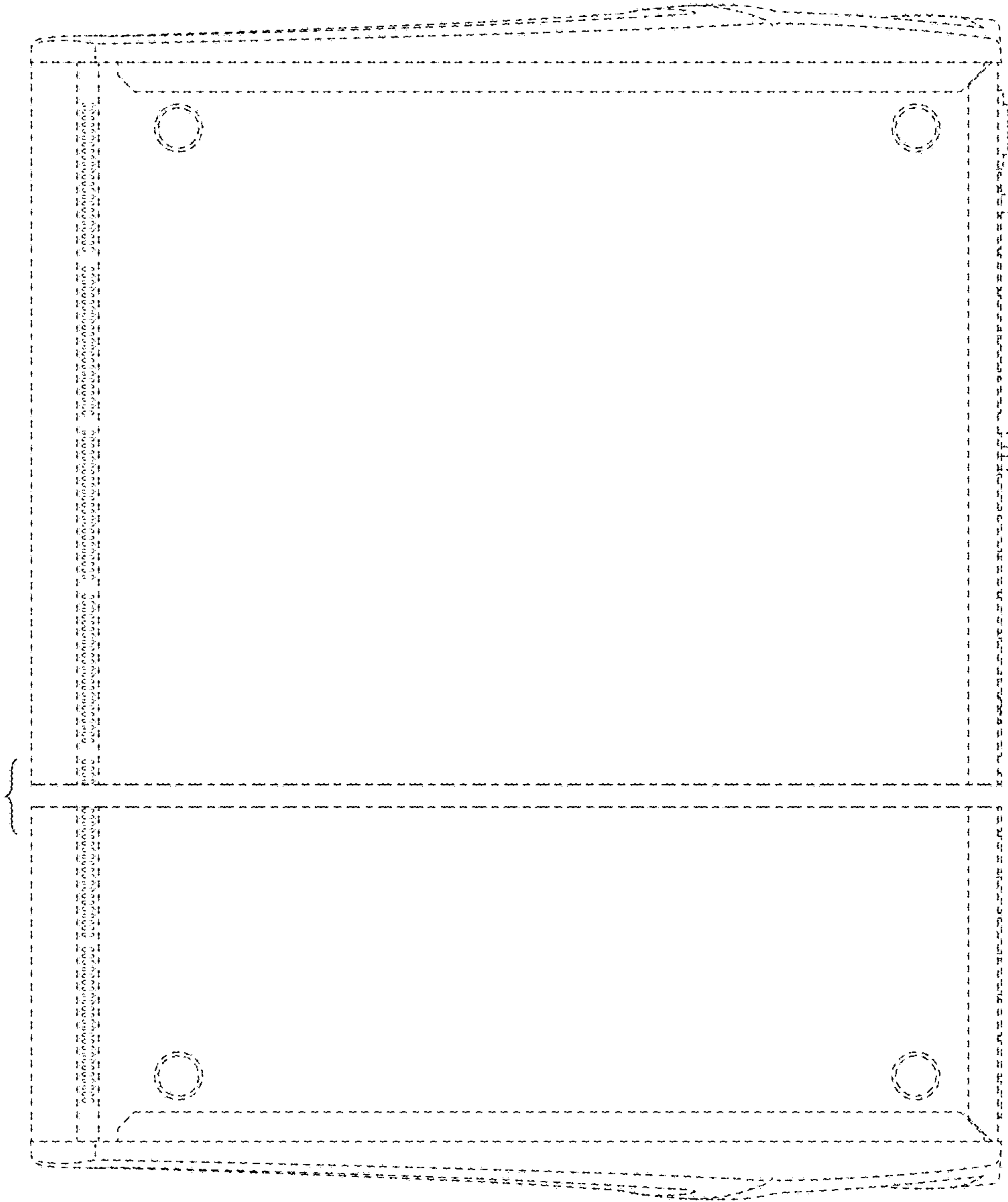

FIG. 14