



US00D778245S

(12) **United States Design Patent**
Feldstein et al.

(10) **Patent No.:** **US D778,245 S**

(45) **Date of Patent:** **** Feb. 7, 2017**

(54) **CONTROL PANEL**

(71) Applicant: **Crestron Electronics, Inc.**, Rockleigh, NJ (US)

(72) Inventors: **Wendy Feldstein**, Old Tappan, NJ (US); **Howard Balch**, Bloomingdale, NJ (US); **Sae Jhun**, Bayside, NY (US); **Don Florczak**, Tenafly, NJ (US)

(73) Assignee: **Crestron Electronics, Inc.**, Rockleigh, NJ (US)

(**) Term: **15 Years**

(21) Appl. No.: **29/559,337**

(22) Filed: **Mar. 28, 2016**

Related U.S. Application Data

(63) Continuation of application No. 29/559,335, filed on Mar. 28, 2016.

(51) **LOC (10) Cl.** **13-03**

(52) **U.S. Cl.**
USPC **D13/162**

(58) **Field of Classification Search**
USPC D13/162, 163, 168; D10/49, 50; D14/126, 336, 341, 371, 374
CPC F24F 11/00; F24F 11/0012; F24F 11/0086; F24F 11/0009; F24F 2011/0057; F24F 2011/0073; F24F 2011/0091; G05B 19/0426; G05B 19/409; G05B 15/02; G06F

(Continued)

(56) **References Cited**

U.S. PATENT DOCUMENTS

7,047,092 B2 * 5/2006 Wimsatt G05B 15/02 345/173

D538,234 S 3/2007 Aupperle

(Continued)

Primary Examiner — Selina Sikder

(74) *Attorney, Agent, or Firm* — Crestron Electronics, Inc

(57) **CLAIM**

The ornamental design for a control panel, as shown and described.

DESCRIPTION

FIG. 1 shows a front perspective view of a control panel according a first embodiment.

FIG. 2 shows a front elevation view of the control panel according the first embodiment.

FIG. 3 shows a rear elevation view of the control panel according the first embodiment.

FIG. 4 shows a top view of the control panel according the first embodiment.

FIG. 5 shows a bottom view of the control panel according the first embodiment.

FIG. 6 shows a left side view of the control panel according the first embodiment.

FIG. 7 shows a right side view of the control panel according the first embodiment.

FIG. 8 shows a front perspective view of a control panel according a second embodiment.

FIG. 9 shows a front elevation view of the control panel according the second embodiment.

FIG. 10 shows a rear elevation view of the control panel according the second embodiment.

FIG. 11 shows a top view of the control panel according the second embodiment.

FIG. 12 shows a bottom view of the control panel according the second embodiment.

FIG. 13 shows a left side view of the control panel according the second embodiment; and,

FIG. 14 shows a right side view of the control panel according the second embodiment.

The broken line portion of the figure drawings is included to show unclaimed subject matter only and forms no part of the claimed design.

1 Claim, 14 Drawing Sheets

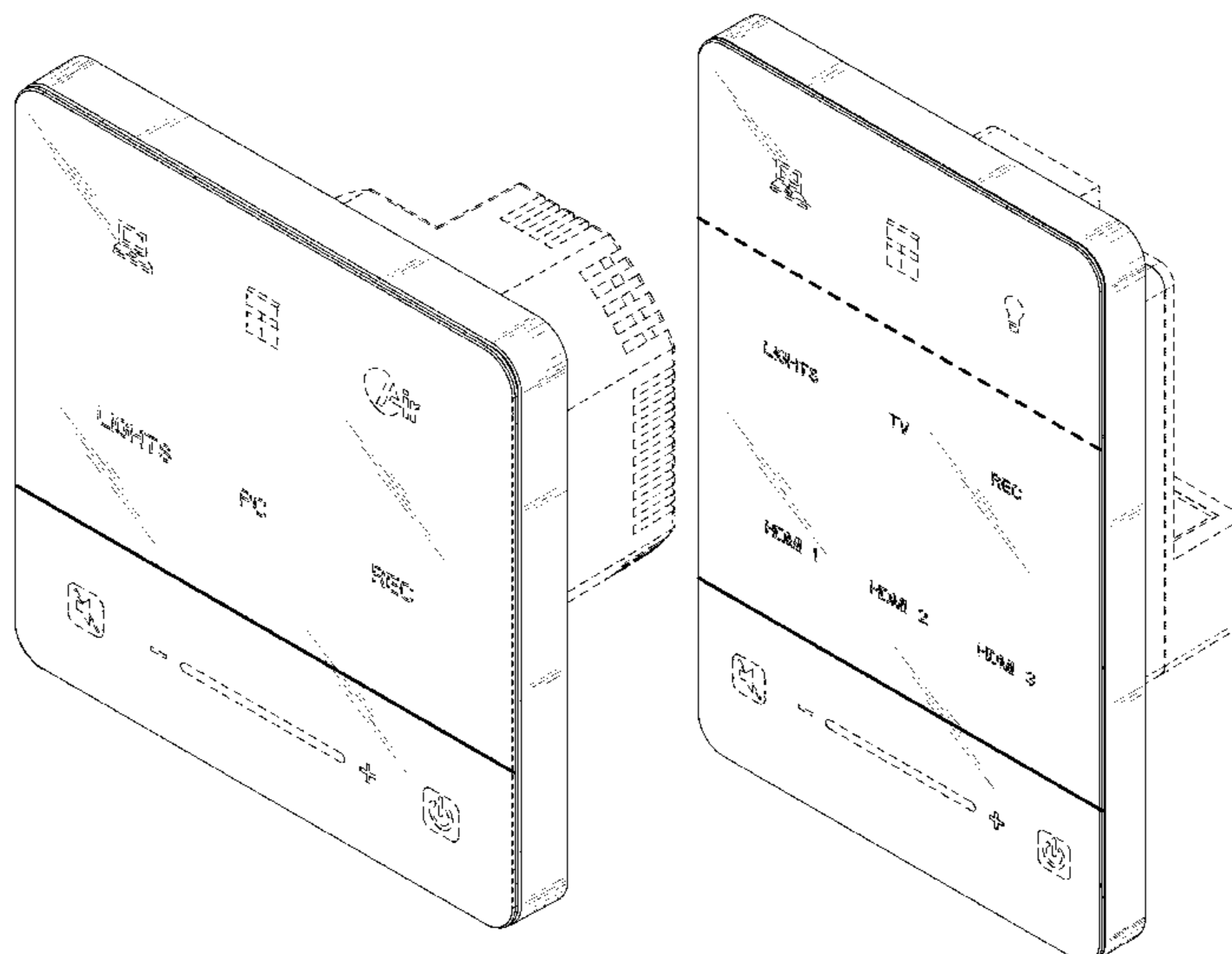

(58) **Field of Classification Search**

CPC 1/1601;G06F 3/0482; G06F 3/0489;
 G05D 23/1902; G05D 23/1905; G05D
 23/1931; H05B 37/02

See application file for complete search history.

(56) **References Cited**

U.S. PATENT DOCUMENTS

D571,675	S	6/2008	Skaf et al.	
D640,992	S	7/2011	Margolin et al.	
D645,001	S	9/2011	Margolin et al.	
8,149,222	B2 *	4/2012	Hsieh	G06F 3/041 345/173
D658,591	S	5/2012	Margolin et al.	
D678,218	S	3/2013	Sheen	
D687,388	S *	8/2013	Baumgartner	D13/162
D690,661	S *	10/2013	Wisniewski	D13/162
D694,195	S *	11/2013	Gammon	D13/162
D711,837	S	8/2014	Clymer et al.	
8,802,981	B2 *	8/2014	Wallaert	F24F 11/00 174/489
D719,107	S	12/2014	Clymer et al.	
D727,271	S *	4/2015	Shi	D13/162
D727,857	S *	4/2015	Acera	D13/162
D735,144	S	7/2015	Restrepo et al.	
D737,697	S *	9/2015	Bhattacharya	D10/50
D738,229	S *	9/2015	Jiang	D10/50
D743,349	S *	11/2015	Leeland	D10/50
D744,433	S	12/2015	Baumgartner et al.	
D758,217	S *	6/2016	Kumfer	D10/50
2010/0106305	A1 *	4/2010	Pavlak	F24F 11/001 700/276
2013/0184880	A1 *	7/2013	McMahon	G05B 15/02 700/286
2014/0070707	A1 *	3/2014	Nagazoe	H04B 10/116 315/151

* cited by examiner

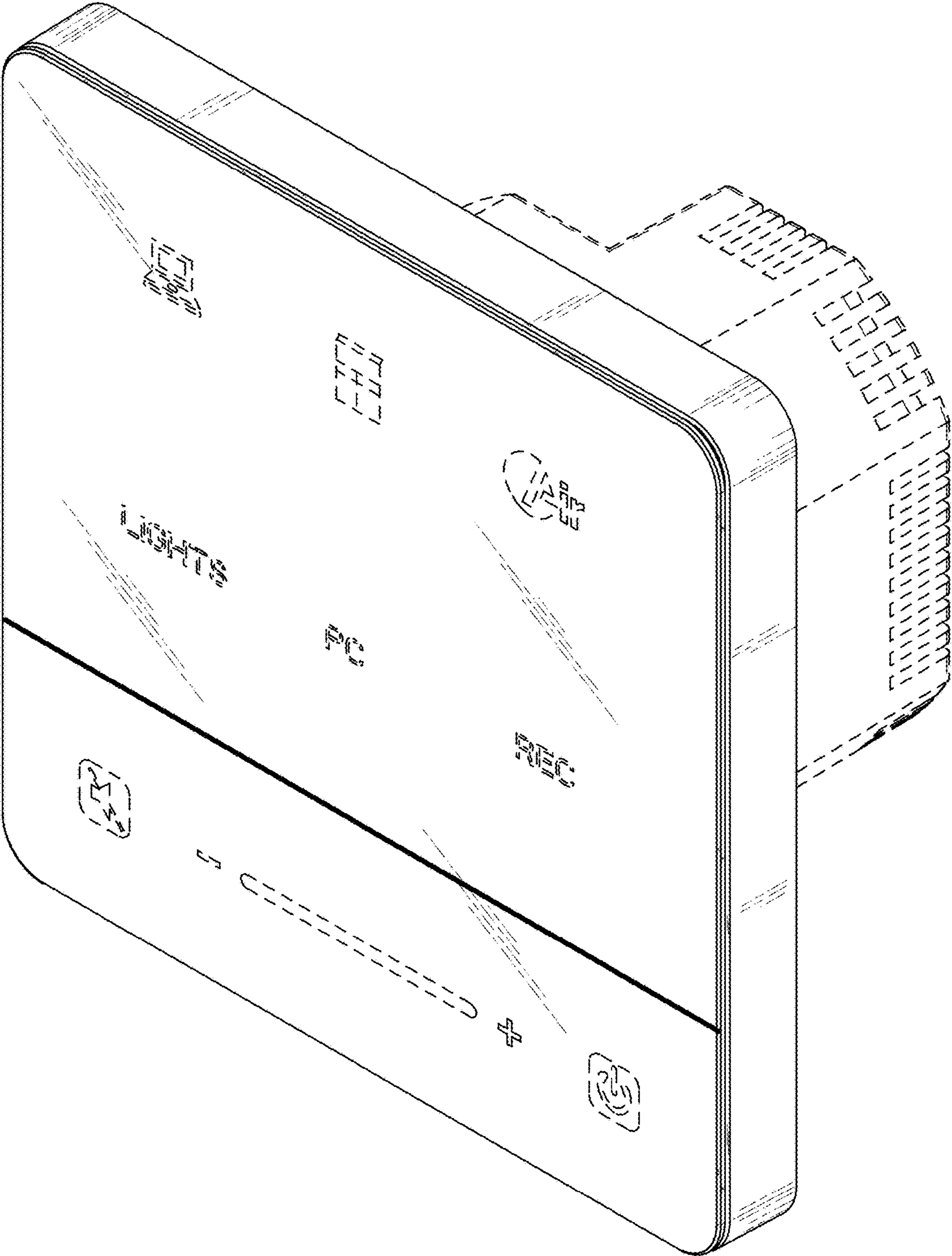

FIG. 1

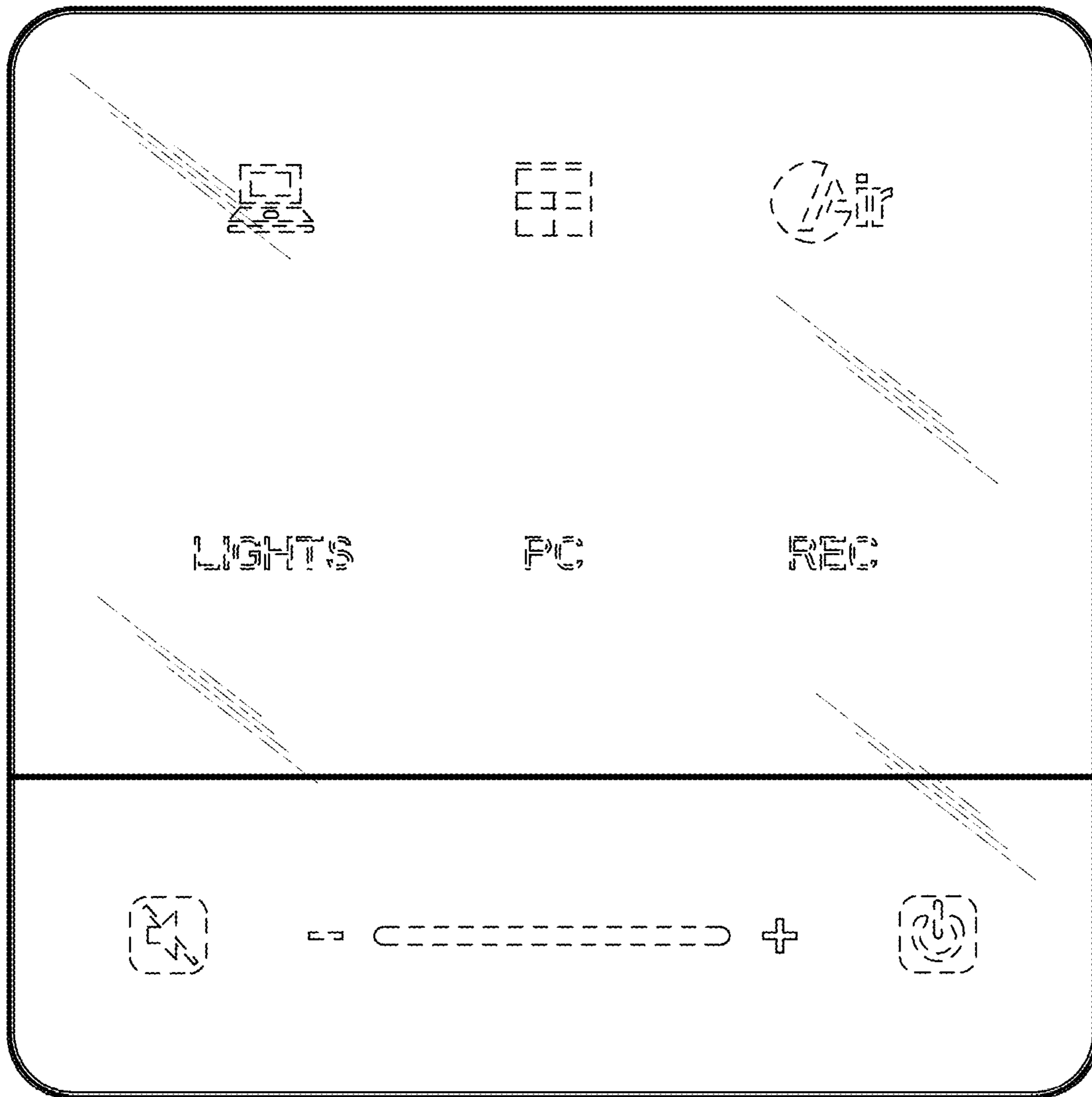

FIG. 2

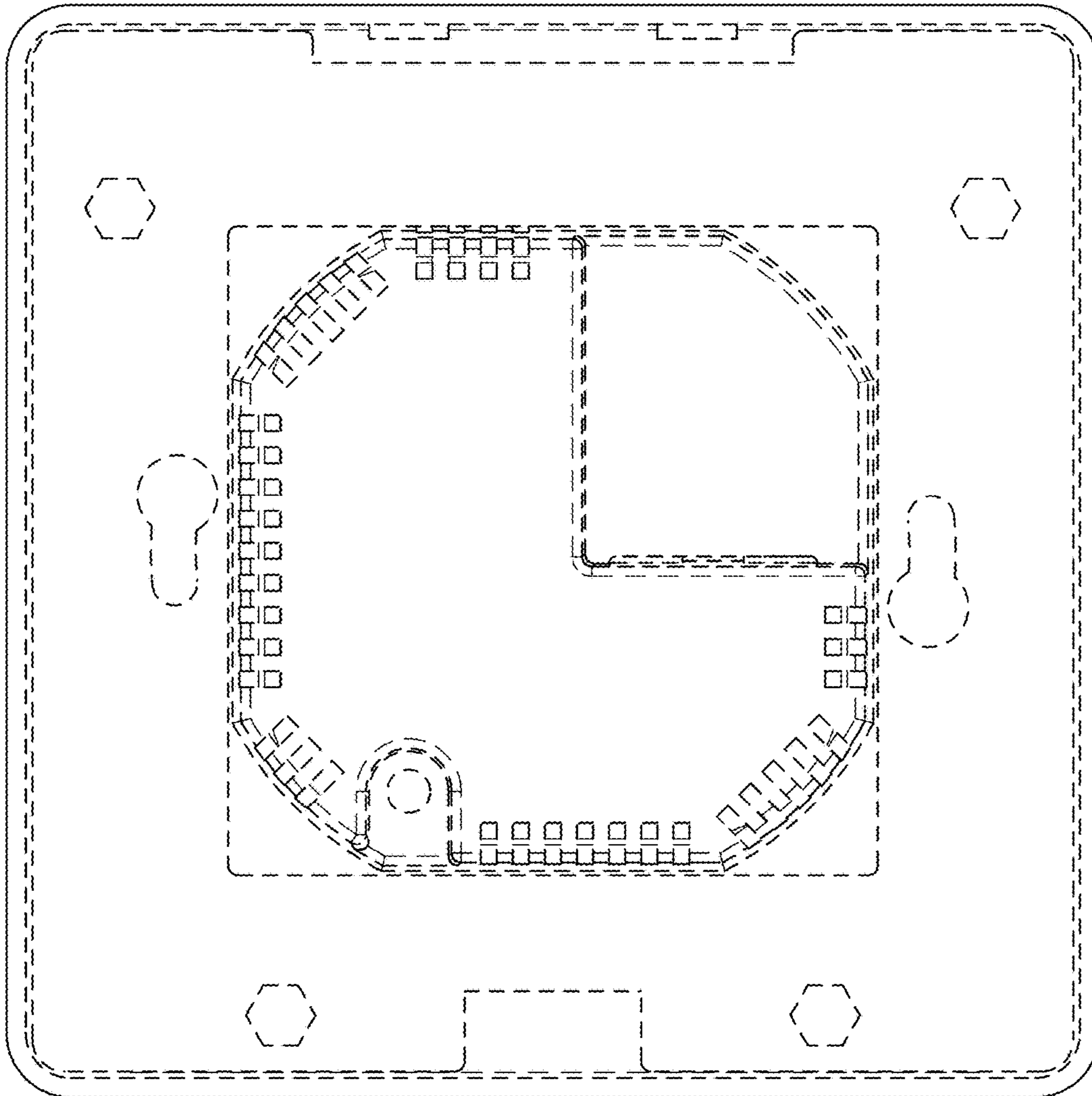

FIG. 3

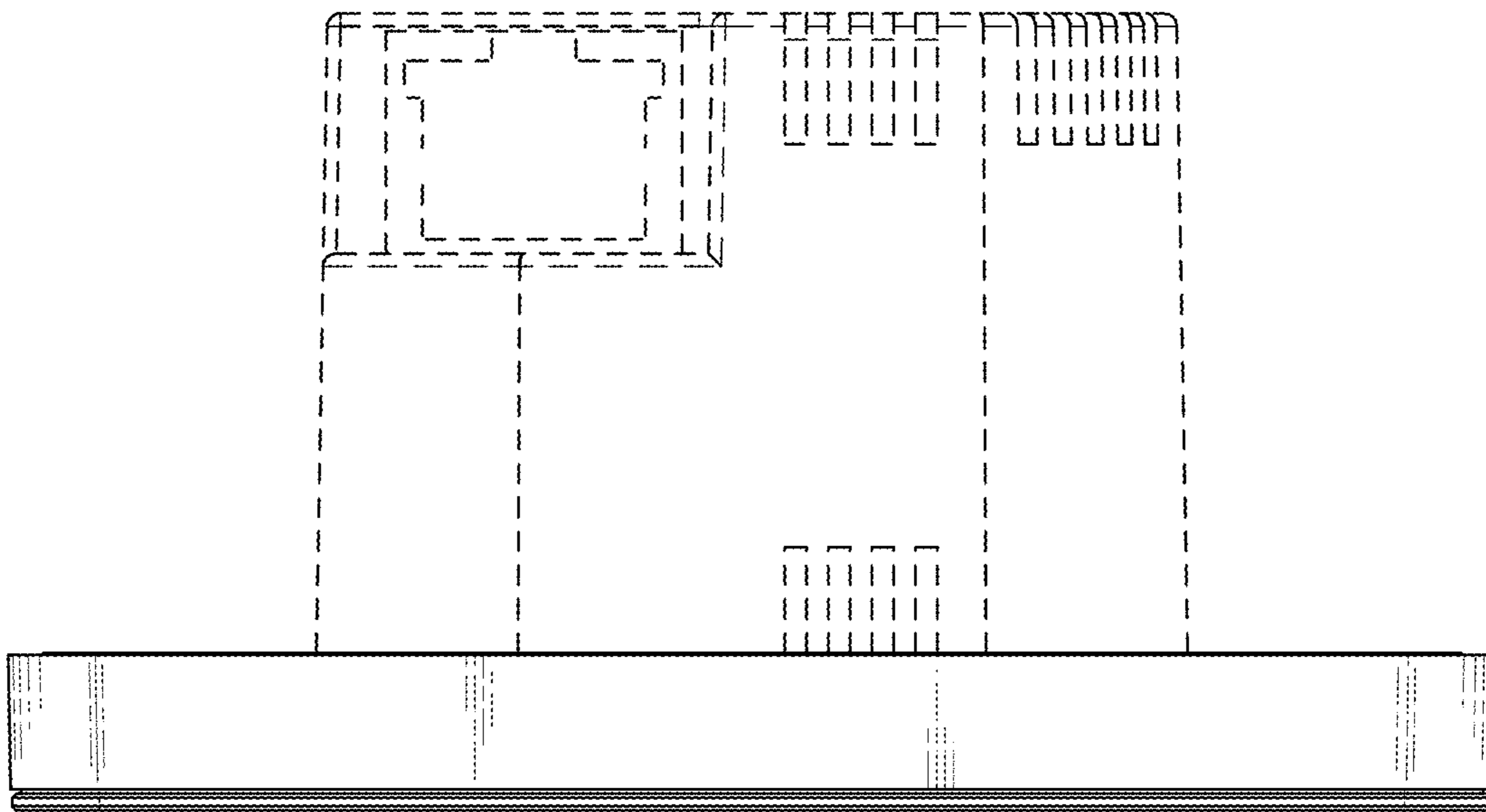

FIG. 4

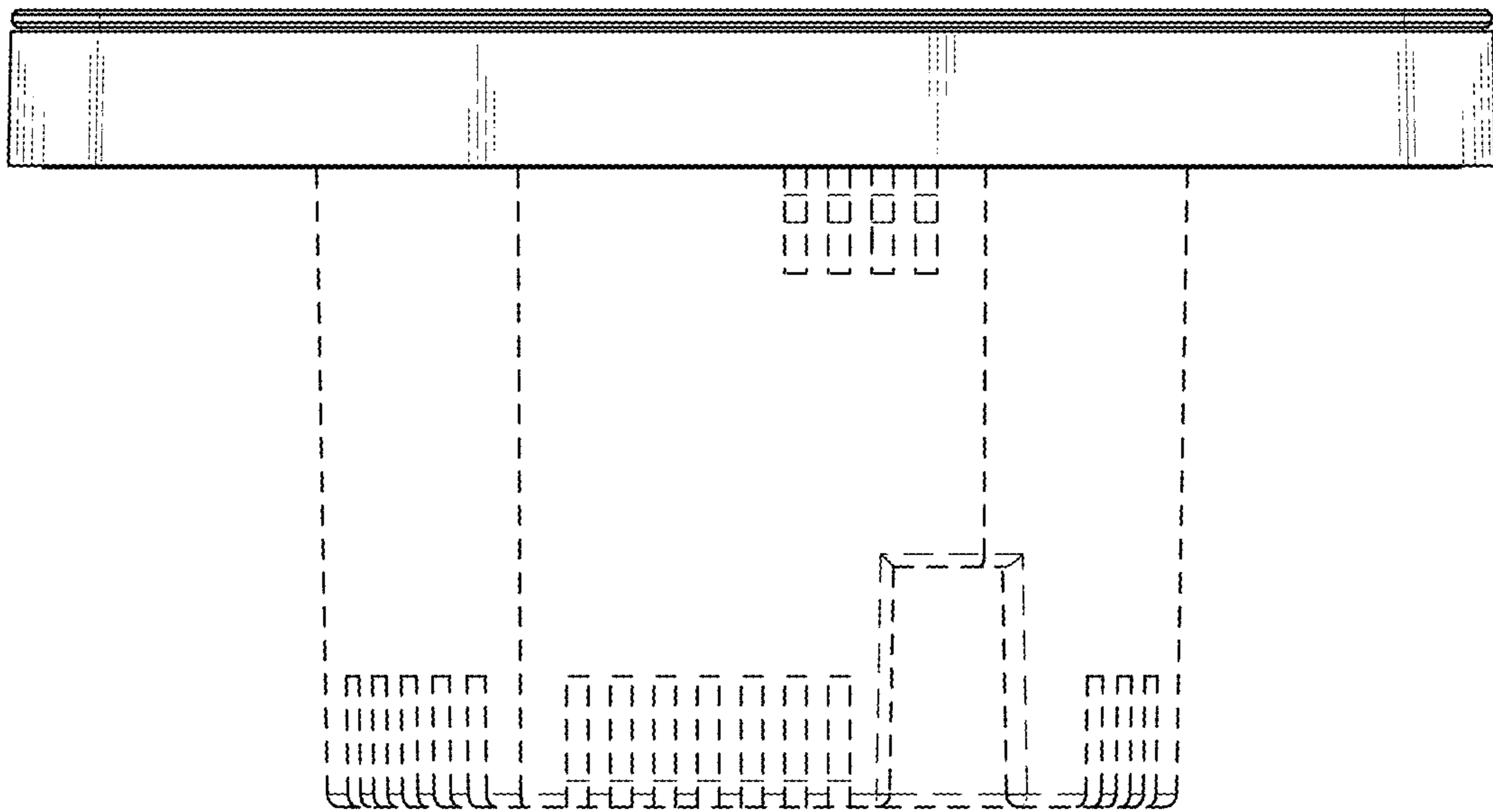

FIG. 5

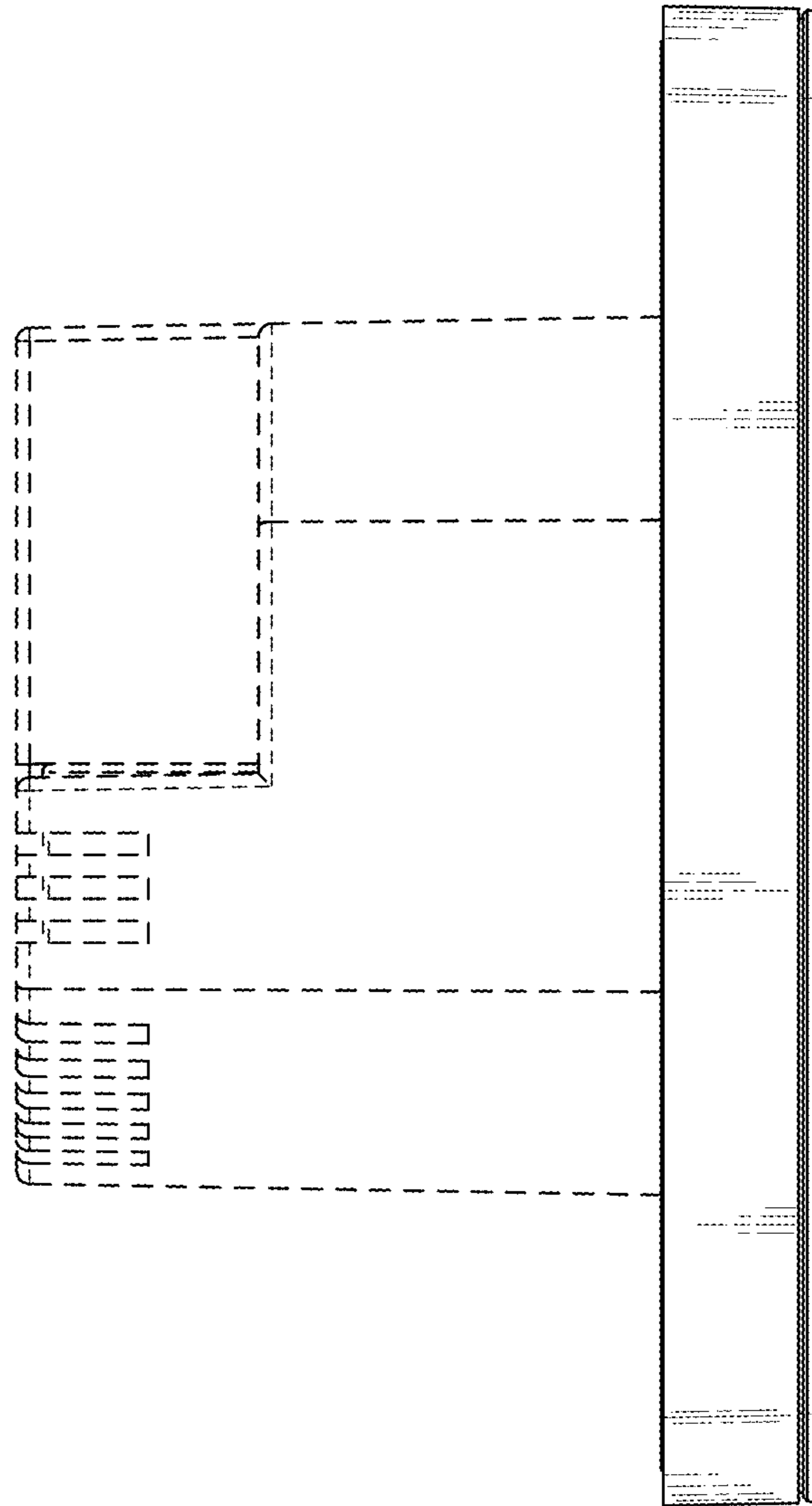

FIG. 6

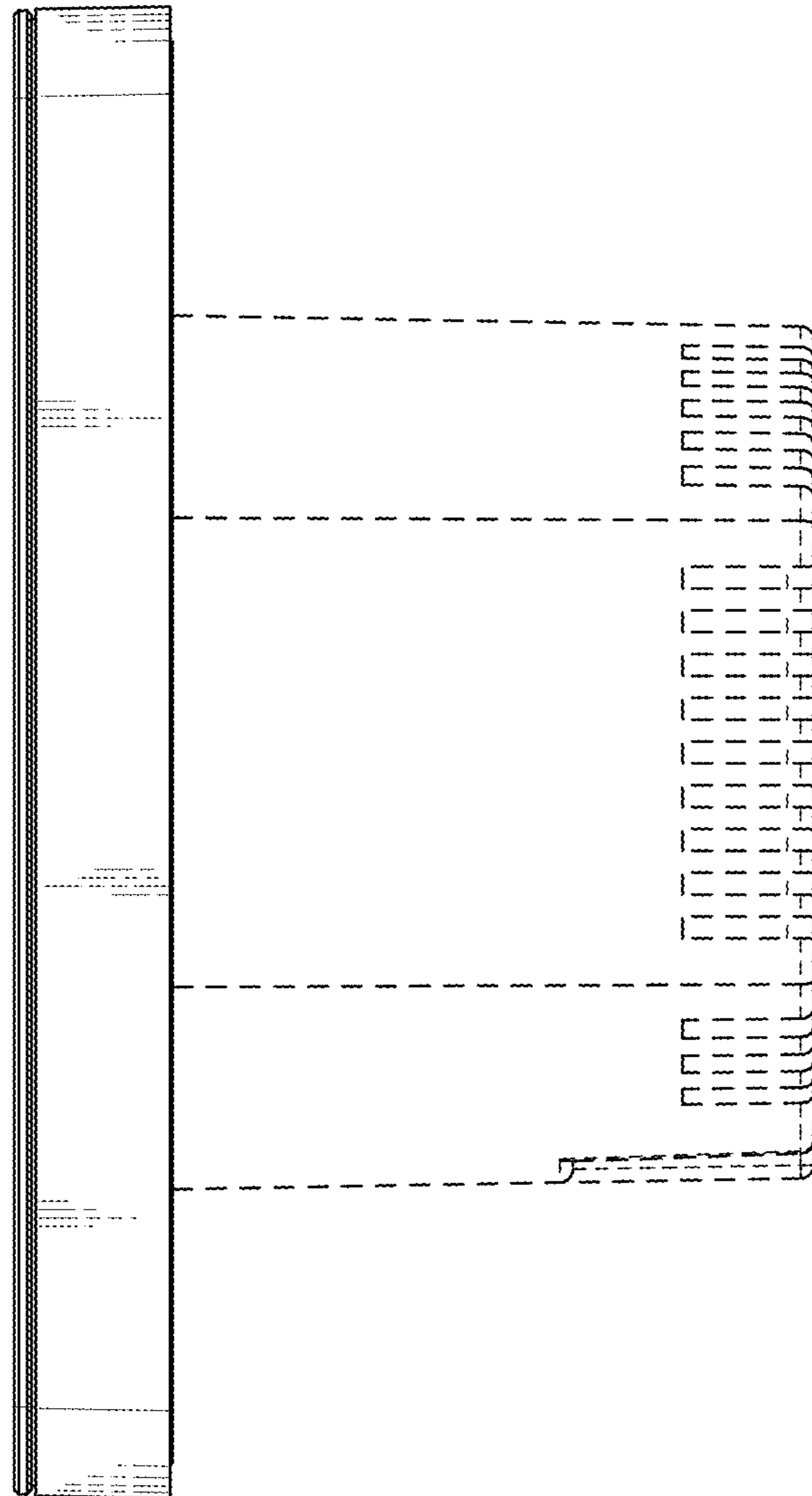

FIG. 7

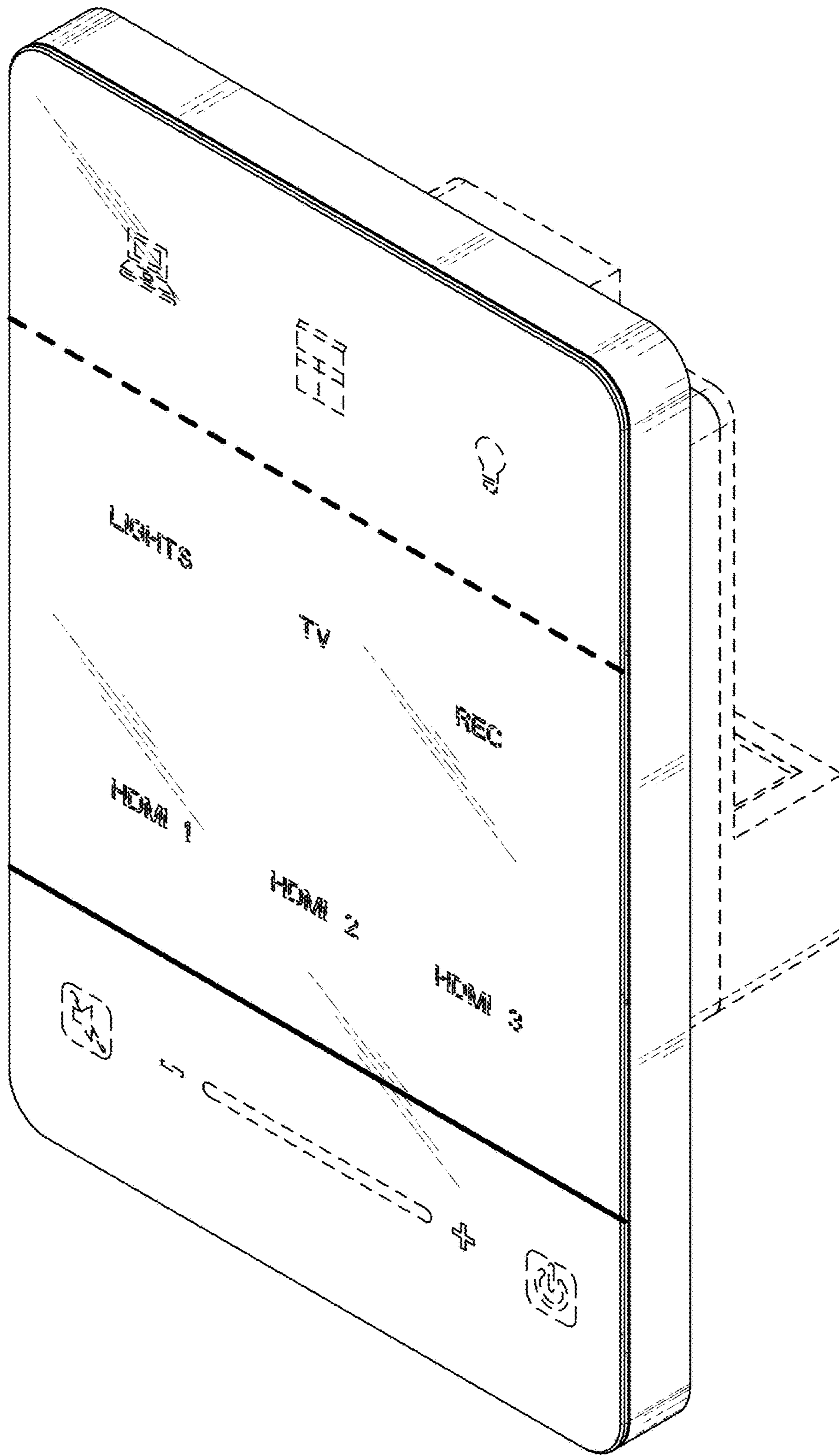

FIG. 8

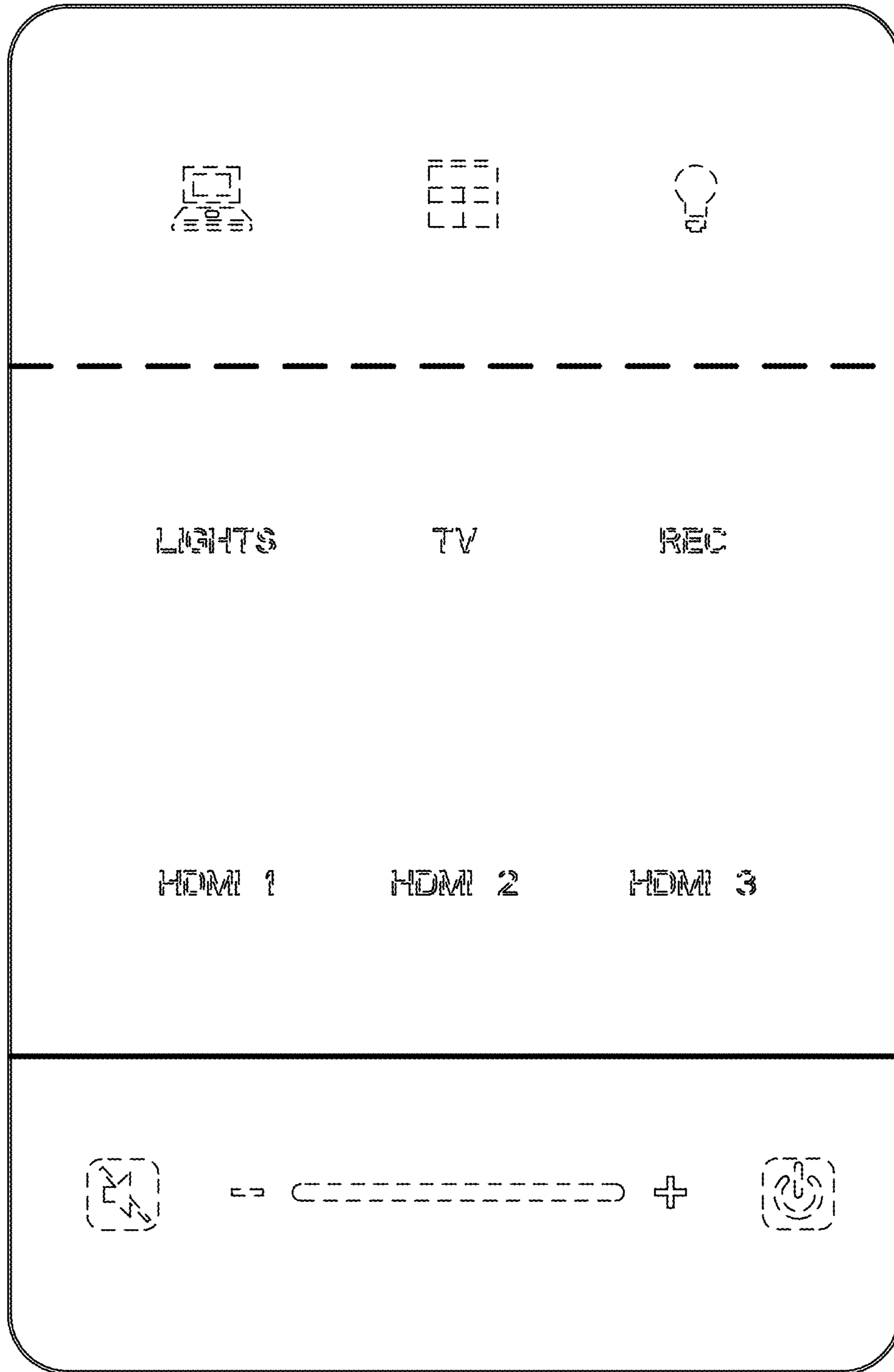

FIG. 9

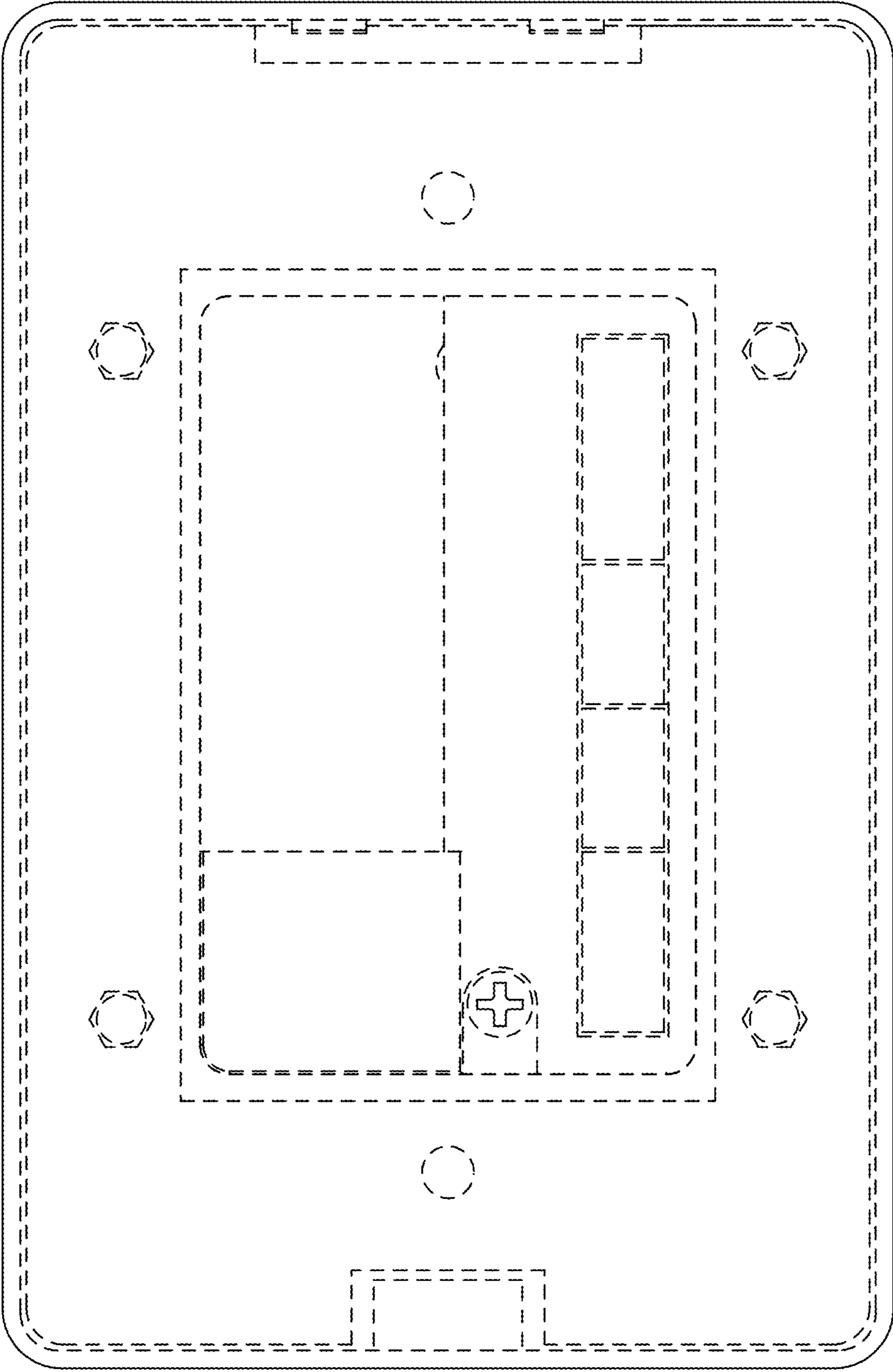

FIG. 10

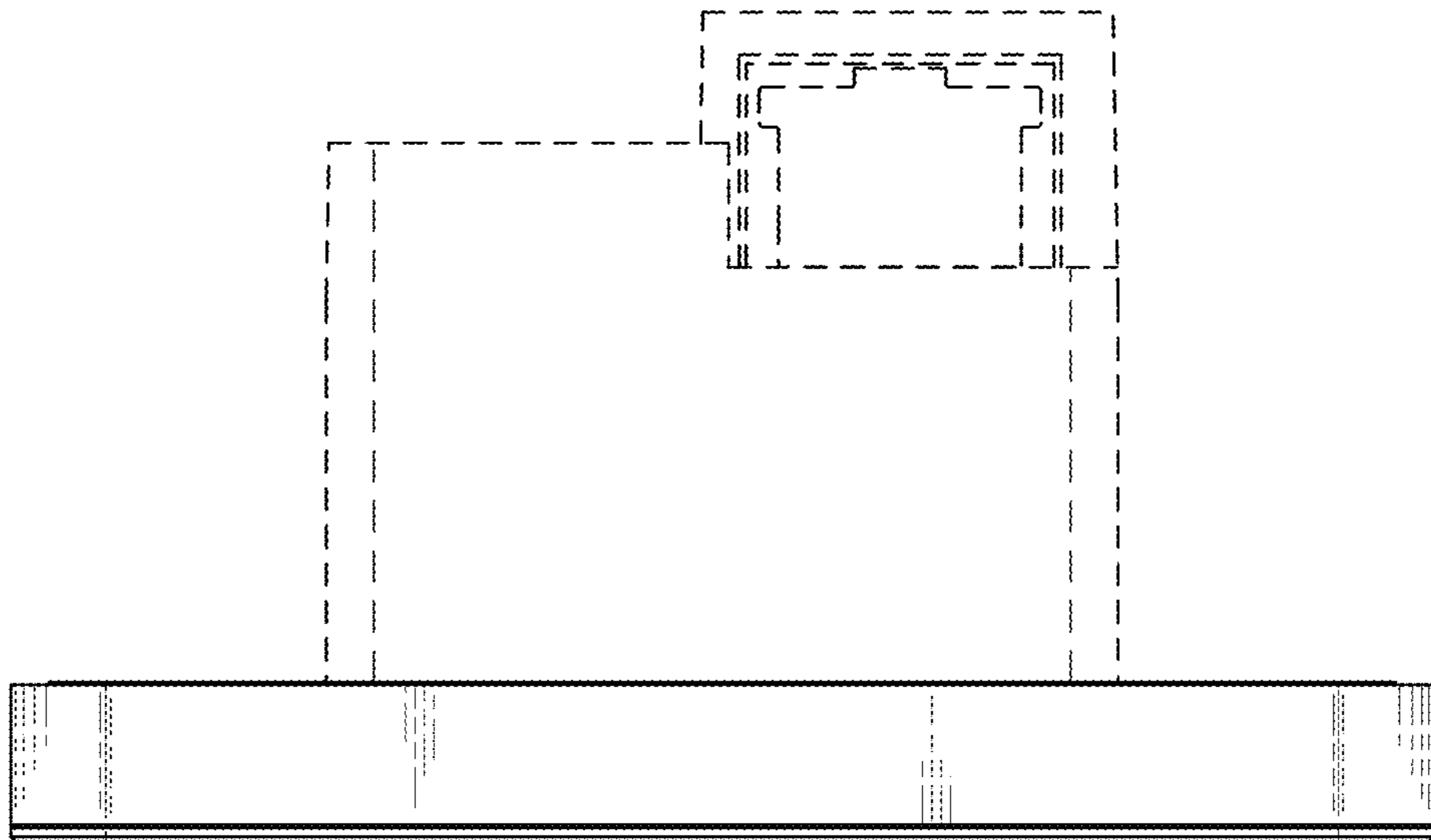

FIG. 11

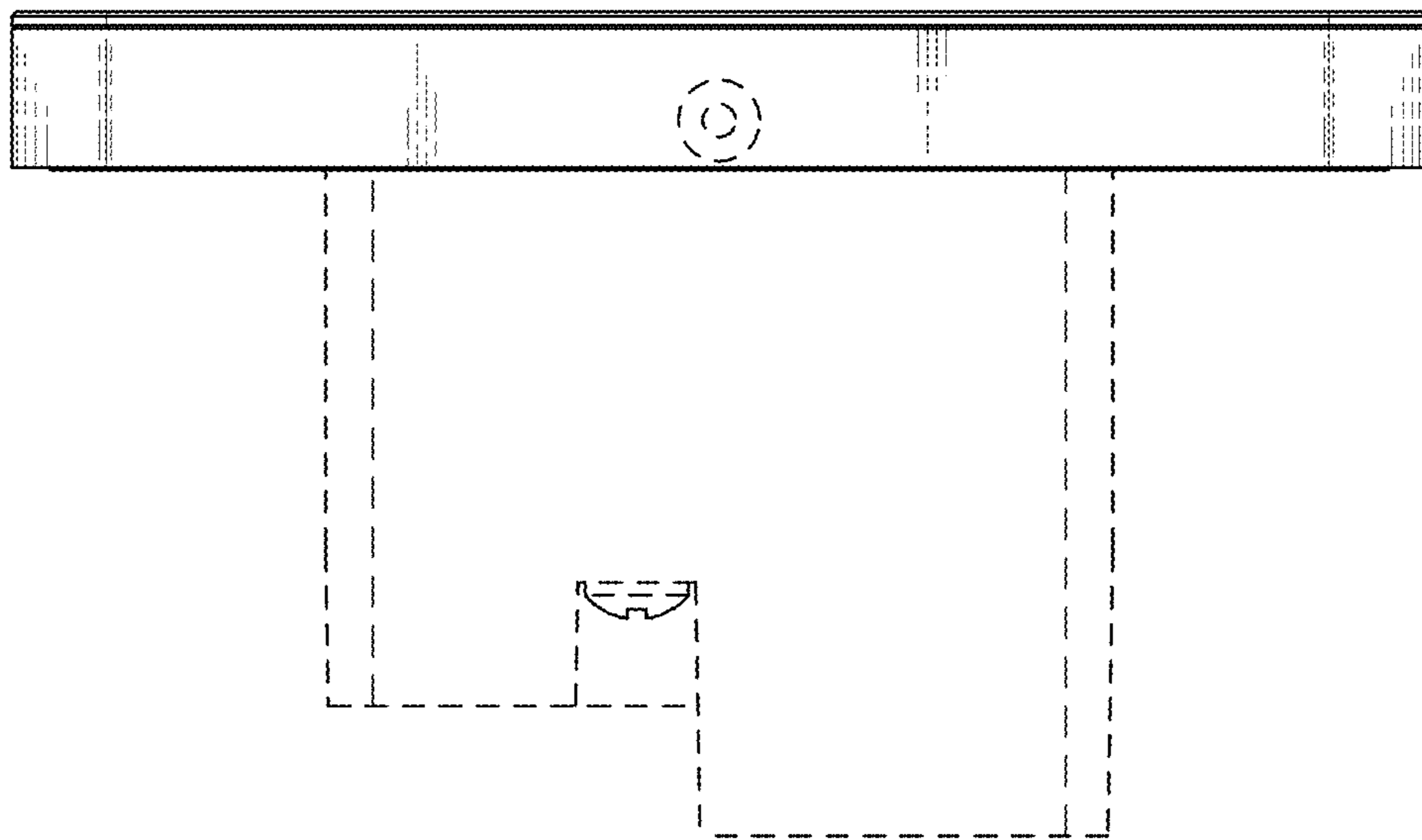

FIG. 12

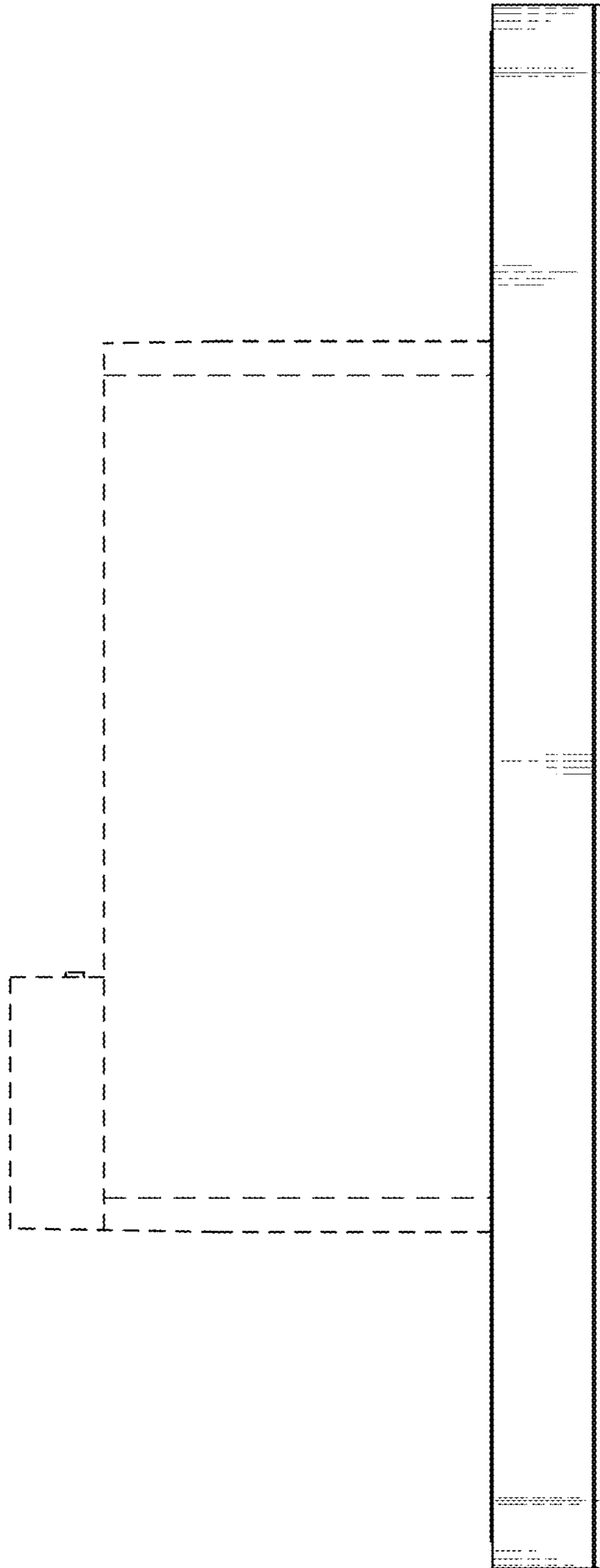

FIG. 13

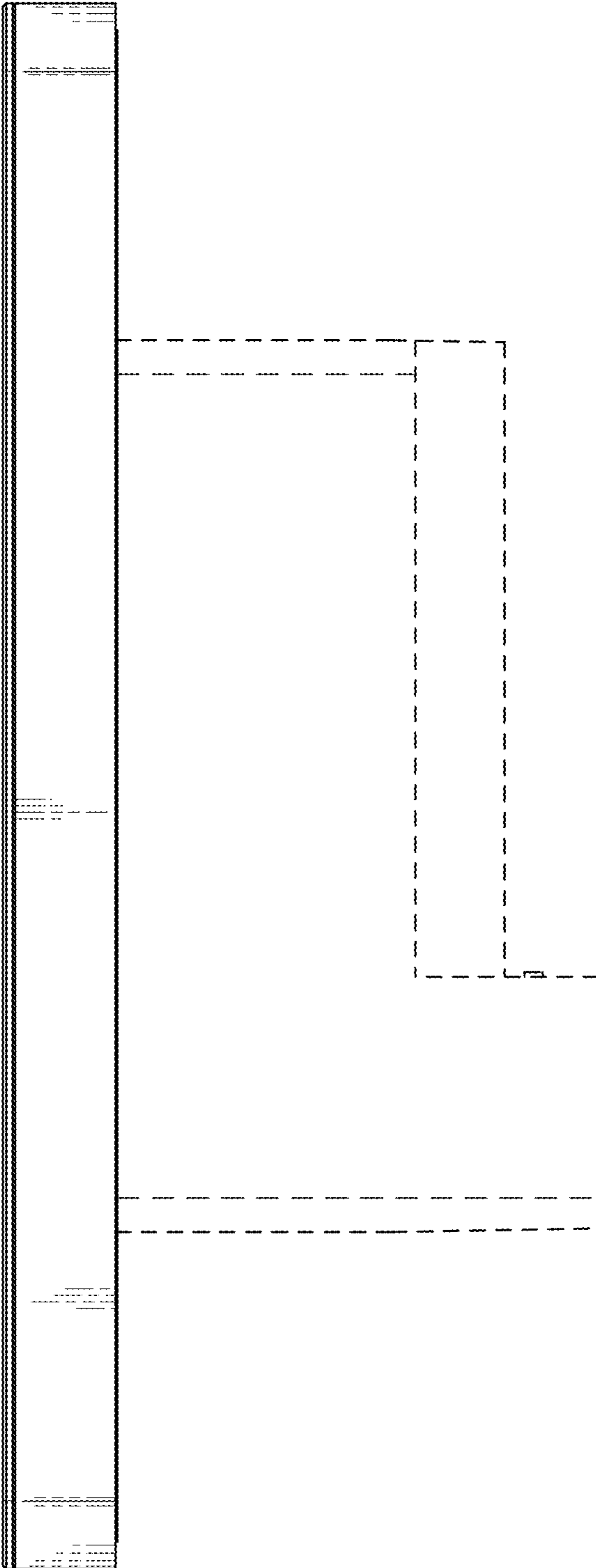

FIG. 14