



US00D778170S

(12) **United States Design Patent** (10) **Patent No.:** **US D778,170 S**
Kim (45) **Date of Patent:** **** Feb. 7, 2017**

(54) **CONTAINER**

(71) Applicant: **MAYWELL CO. LTD.**, Seoul (KR)

(72) Inventor: **Taewoo Kim**, Kyunggido (KR)

(73) Assignee: **Maywell Co. Ltd.**, Seoul (KR)

(**) Term: **15 Years**

(21) Appl. No.: **29/541,342**

(22) Filed: **Oct. 2, 2015**

(51) **LOC (10) Cl.** **09-01**

(52) **U.S. Cl.**

USPC **D9/687**; D9/686

(58) **Field of Classification Search**

USPC D9/600-681, 682-694, 715, 719,
D9/737-747, 723-729, 500-505,
D9/516-575, 435, 436, 445, 448, 451

CPC B65D 2501/0009; B65D 2501/0081;
B65D 1/02; B65D 1/0207; B65D 1/0215;
B65D 1/0223; B65D 1/023; B65D 1/0238;
B65D 1/0246; B65D 1/0253; B65D
1/0261; B65D 1/0276; B65D
1/0284; B65D 1/40; B65D 1/42; B65D
1/46; B65D 83/14-83/759; A45D 34/00;
A45D 34/02; A45D 2034/005; A45D
2034/007; A45D

(Continued)

(56) **References Cited**

U.S. PATENT DOCUMENTS

D124,598 S * 1/1941 Brodovitch D11/90
3,405,849 A * 10/1968 Kellogg B65D 1/0223
222/498

(Continued)

FOREIGN PATENT DOCUMENTS

EM 001137947-0001 4/2009

Primary Examiner — Catherine Tuttle

(74) *Attorney, Agent, or Firm* — Knobbe, Martens,
Olson & Bear, LLP

(57) **CLAIM**

The ornamental design for a container, as shown and
described.

DESCRIPTION

FIG. 1 is a first perspective view of a container, comprising
a top portion and a bottom portion showing my new design.
FIG. 2 is a front elevational view thereof.

FIG. 3 is a rear elevational view thereof. The left and right
side elevational views are identical to the rear view shown.

FIG. 4 is a top plan view thereof.

FIG. 5 is a bottom plan view thereof.

FIG. 6 is a bottom perspective view thereof.

FIG. 7 is a cross-sectional view taken along line 7-7 of FIG.
4.

FIG. 8 is an perspective view thereof.

FIG. 9 is a cross-sectional view taken along line 9-9 of FIG.
4.

FIG. 10 is a perspective view of the bottom portion of the
container, shown separately for clarity.

FIG. 11 is a front elevational view thereof.

FIG. 12 is a rear elevational view thereof. The left and right
side elevational views are identical to the rear view shown.

FIG. 13 is a top plan view thereof.

FIG. 14 is a bottom plan view thereof.

FIG. 15 is a perspective view of the top portion of the
container, shown separately for clarity.

FIG. 16 is a front elevational view thereof. The rear, left and
right side elevational views are identical to the front view
shown.

FIG. 17 is a top plan view thereof; and,

FIG. 18 is a bottom plan view thereof.

The broken lines are included for the purpose of illustrating
the bottom end recess that forms no part of the claimed
design.

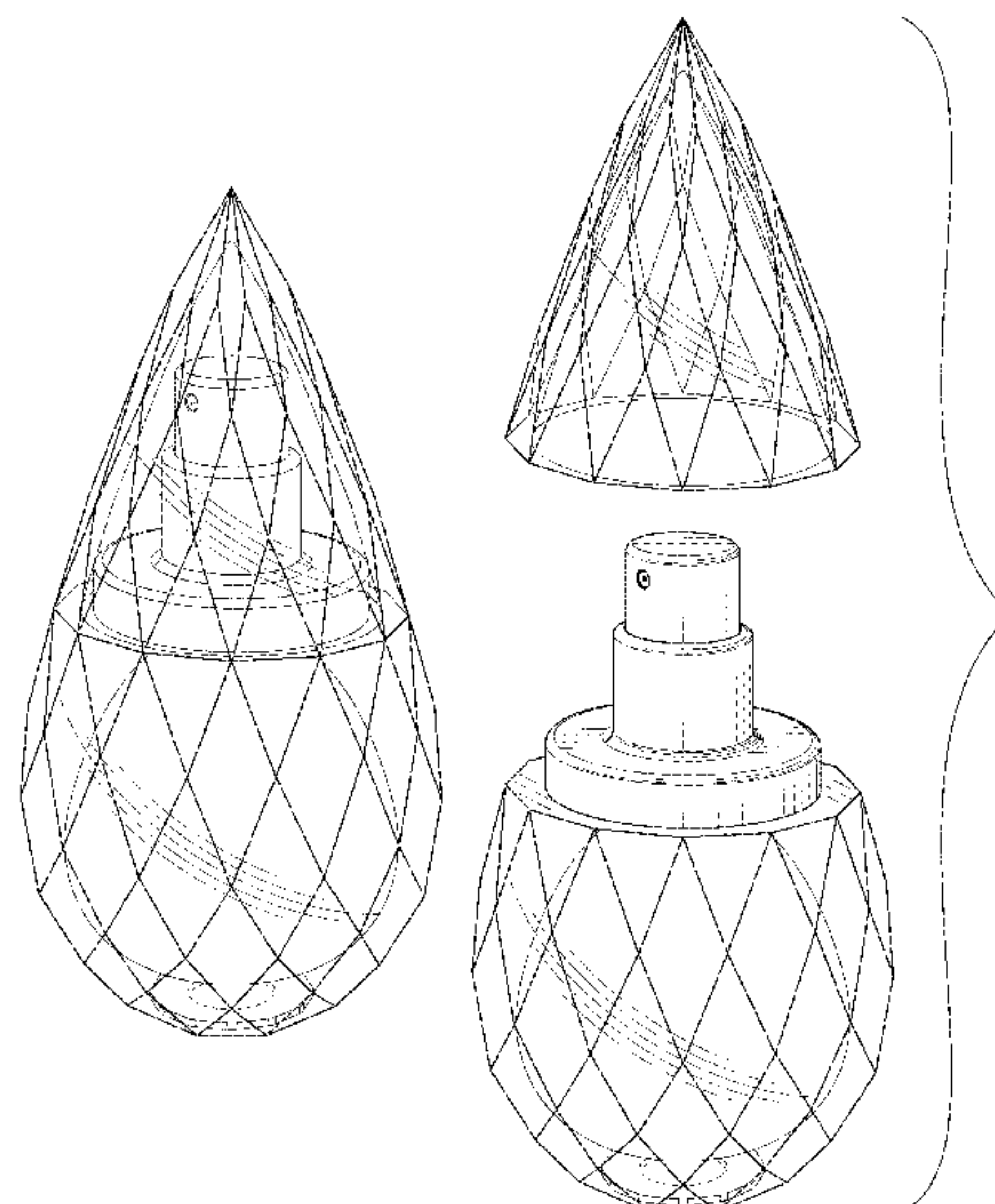

1 Claim, 14 Drawing Sheets

(58) **Field of Classification Search**

CPC .. 2200/055;A45D 2200/056; A45D 2200/057;
 B05B 11/00–11/3098

See application file for complete search history.

D575,643	S *	8/2008	Florio	D9/435
D593,418	S *	6/2009	Lo	D9/451
D596,950	S *	7/2009	Nevins	D9/690
D605,049	S *	12/2009	Tanii	D9/529
D610,916	S *	3/2010	Yeung	D9/682
D646,574	S *	10/2011	Bore	D9/529
D683,238	S *	5/2013	You	D9/688
D698,259	S *	1/2014	Ngjelo	D9/546
D703,546	S *	4/2014	De Baschmakoff	D9/691
D708,789	S *	7/2014	Schlatter	D28/87
D710,544	S *	8/2014	Shen	D28/77
D722,880	S *	2/2015	DeMarco	D9/529
D748,492	S *	2/2016	Hennessy	D9/691
2011/0266248	A1 *	11/2011	Popiel	B65D 1/0223 215/316
2012/0325810	A1 *	12/2012	Yamamoto	B29C 45/14836 220/62.22
2015/0342411	A1 *	12/2015	Son	B05B 11/0081 366/130

(56) **References Cited**

U.S. PATENT DOCUMENTS

D245,315	S *	8/1977	Mitchell	D9/529
4,676,408	A *	6/1987	Speitel	B65D 83/384 222/183
D425,785	S *	5/2000	Hirato	D9/504
D434,325	S *	11/2000	Jivago	D9/651
D438,098	S *	2/2001	Krunas	D9/691
D449,517	S *	10/2001	Vignon	D9/504
D465,149	S *	11/2002	Bennett	D9/691
D530,221	S *	10/2006	Paglina	D9/692

* cited by examiner

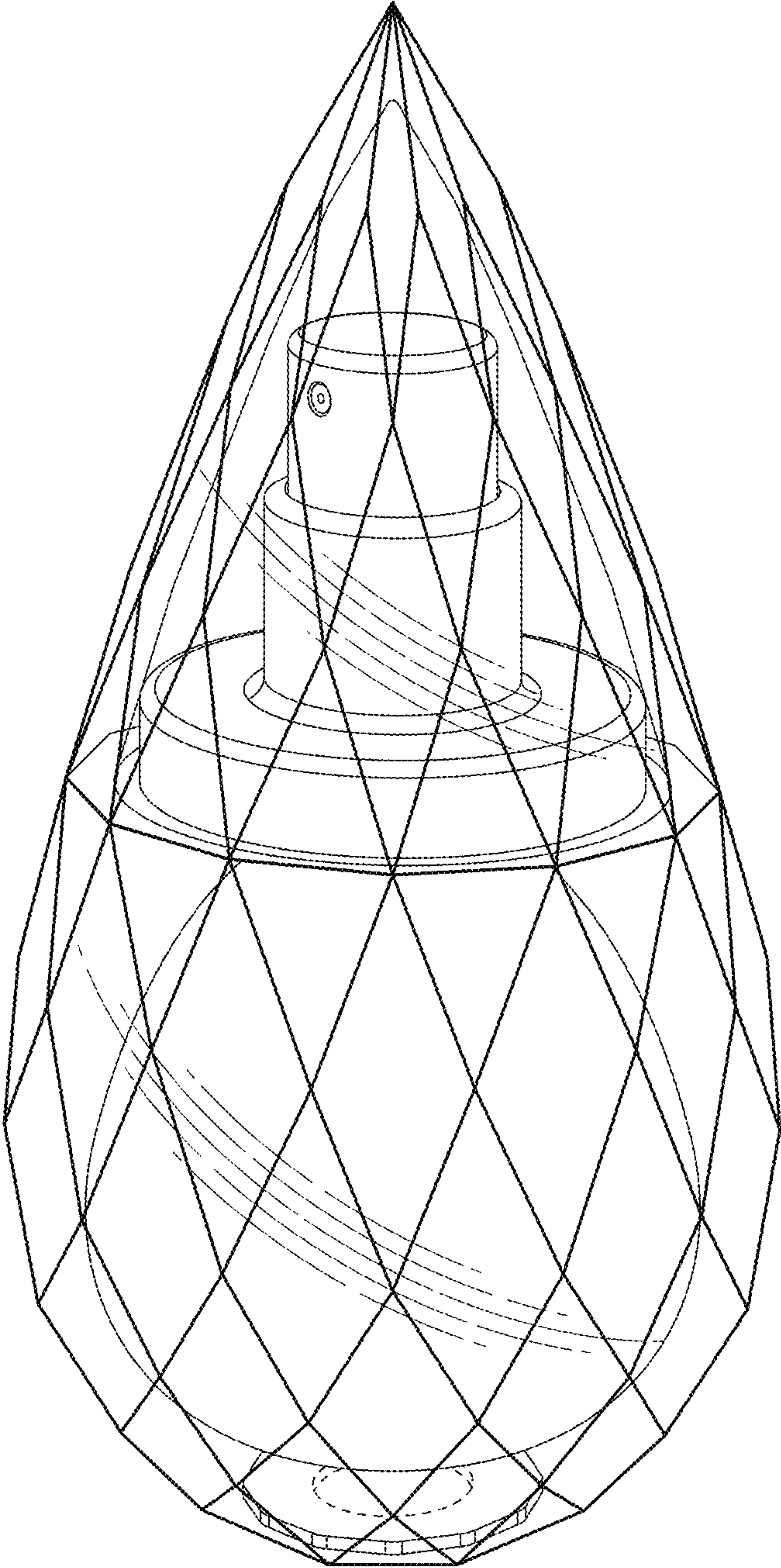

FIG. 1

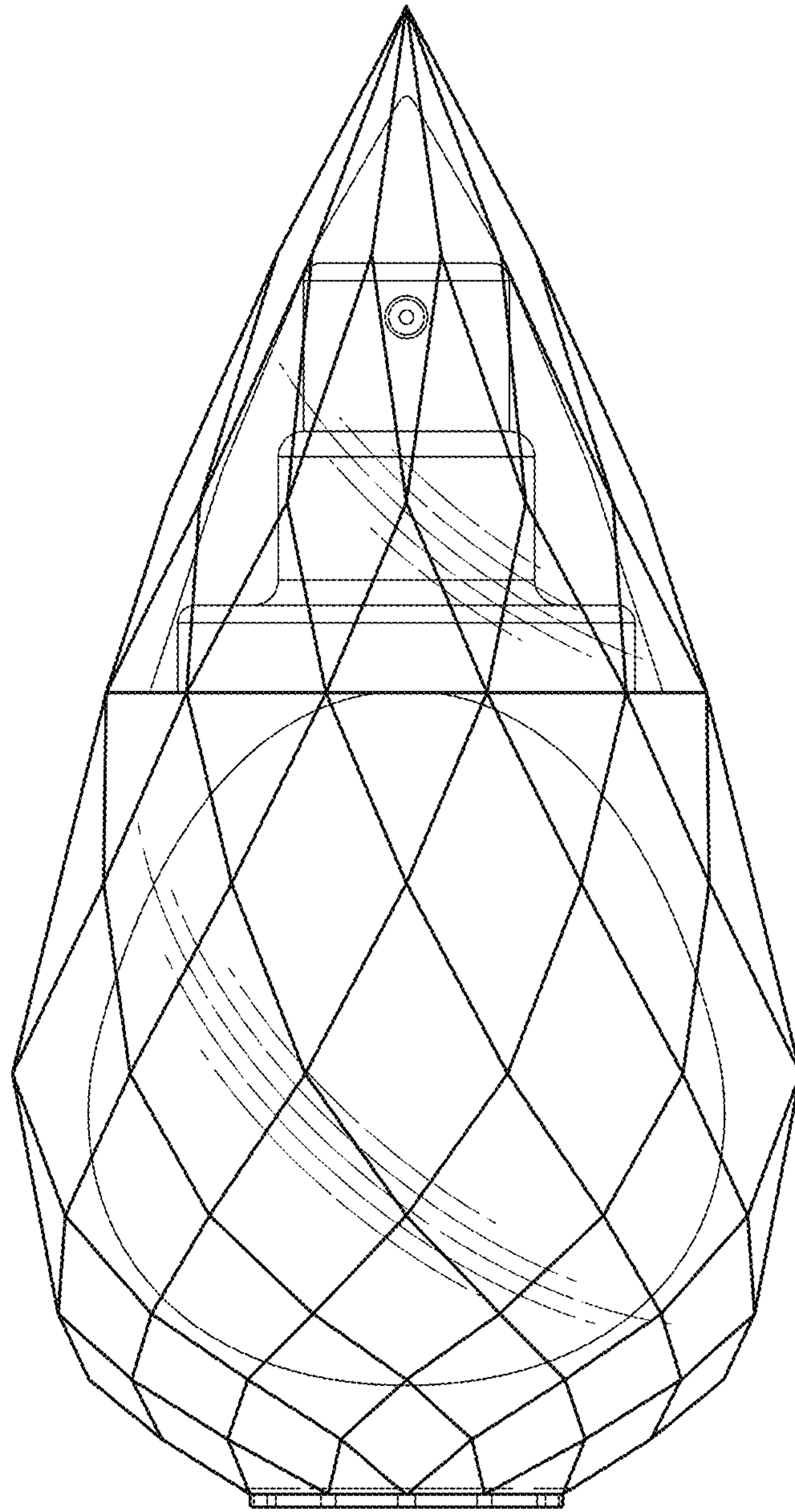

FIG. 2

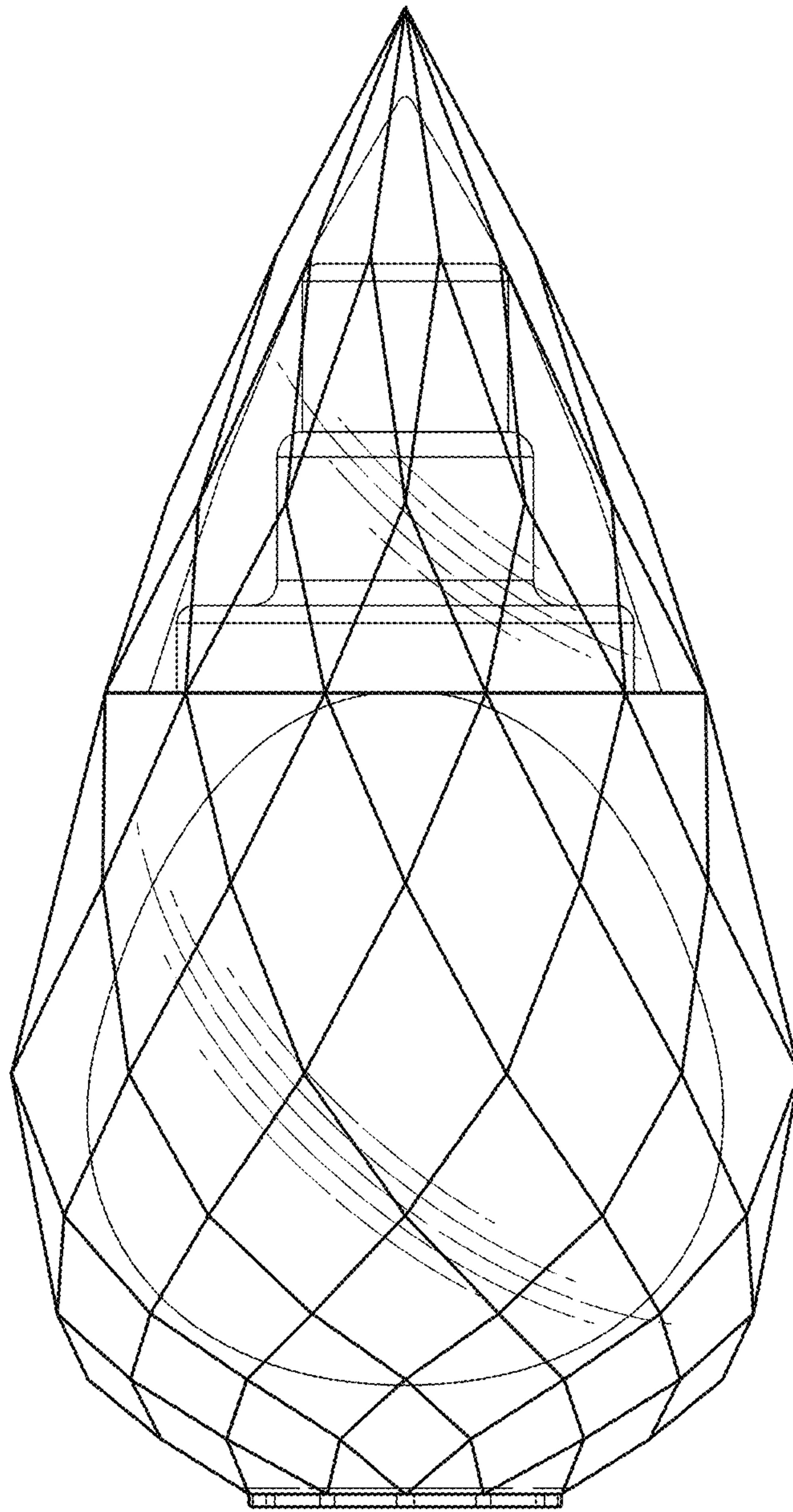

FIG. 3

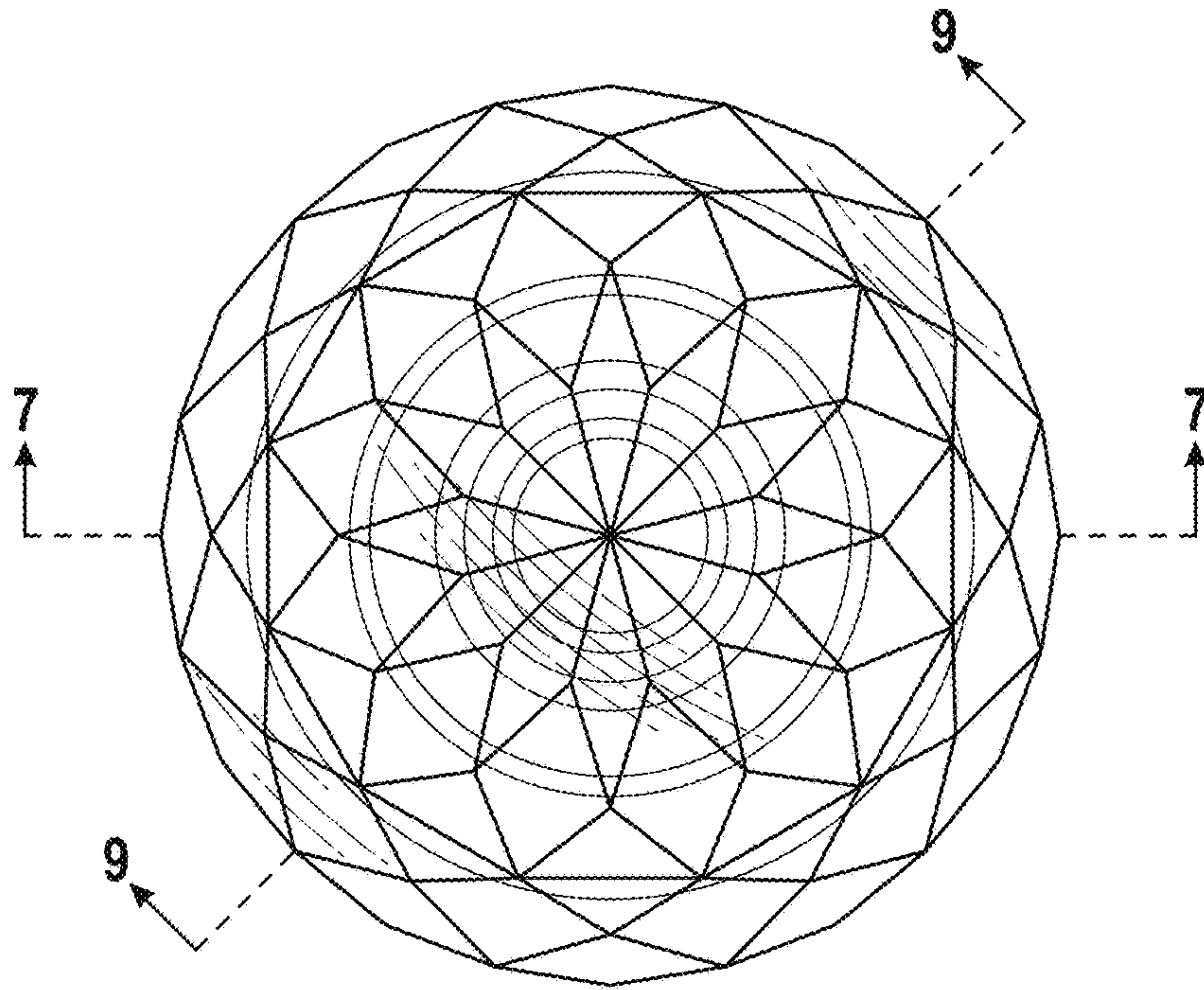

FIG. 4

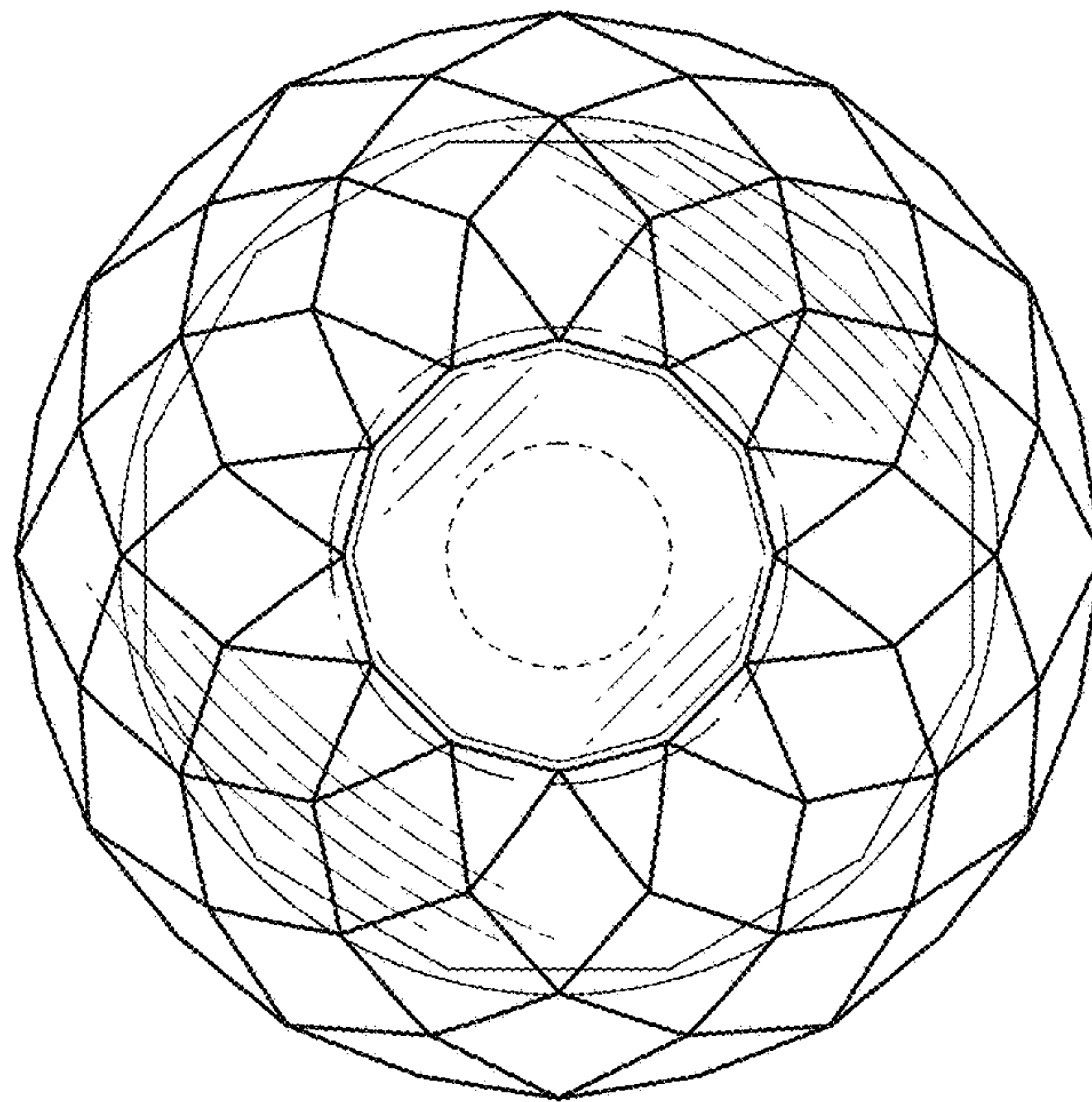

FIG. 5

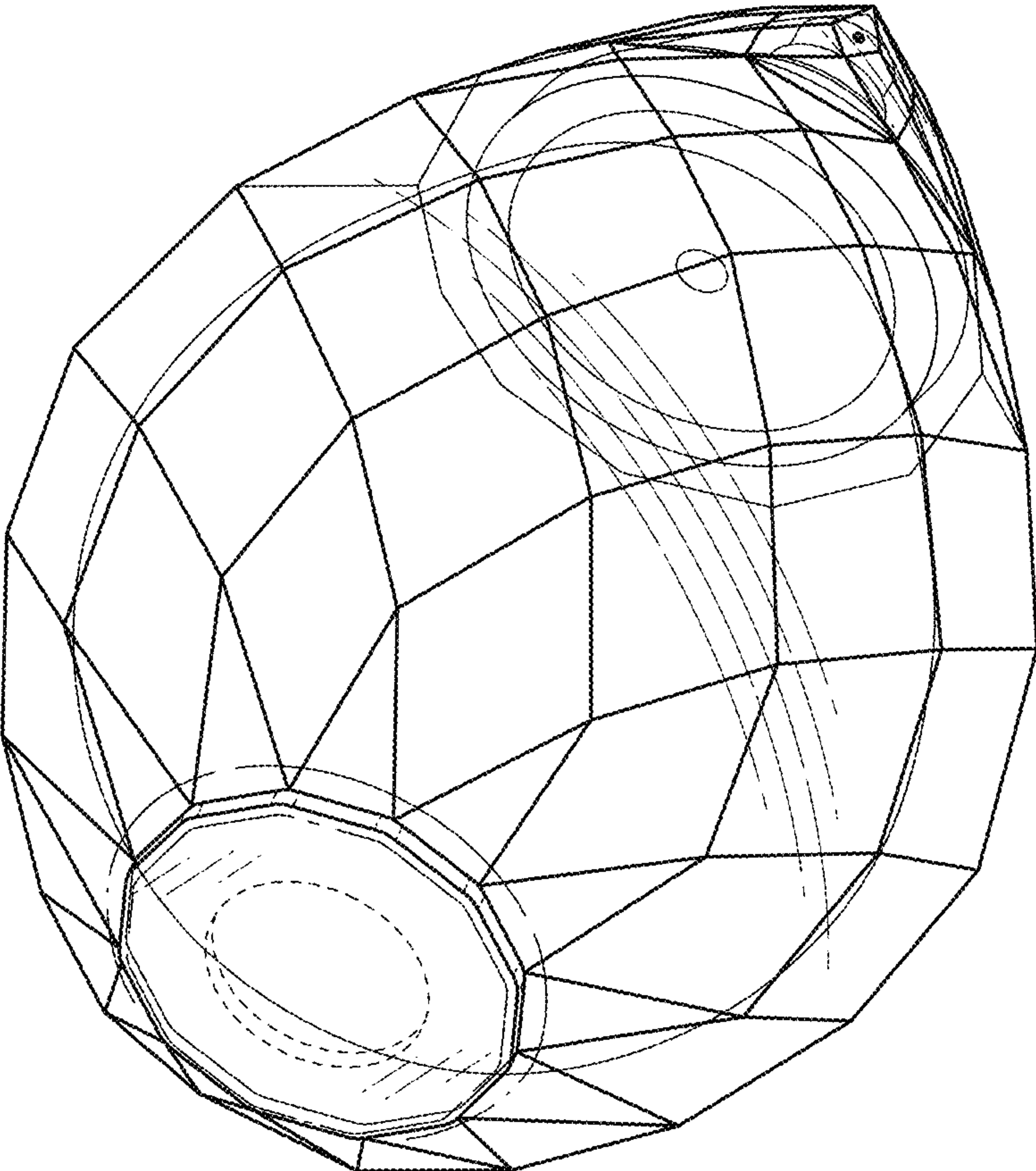

FIG. 6

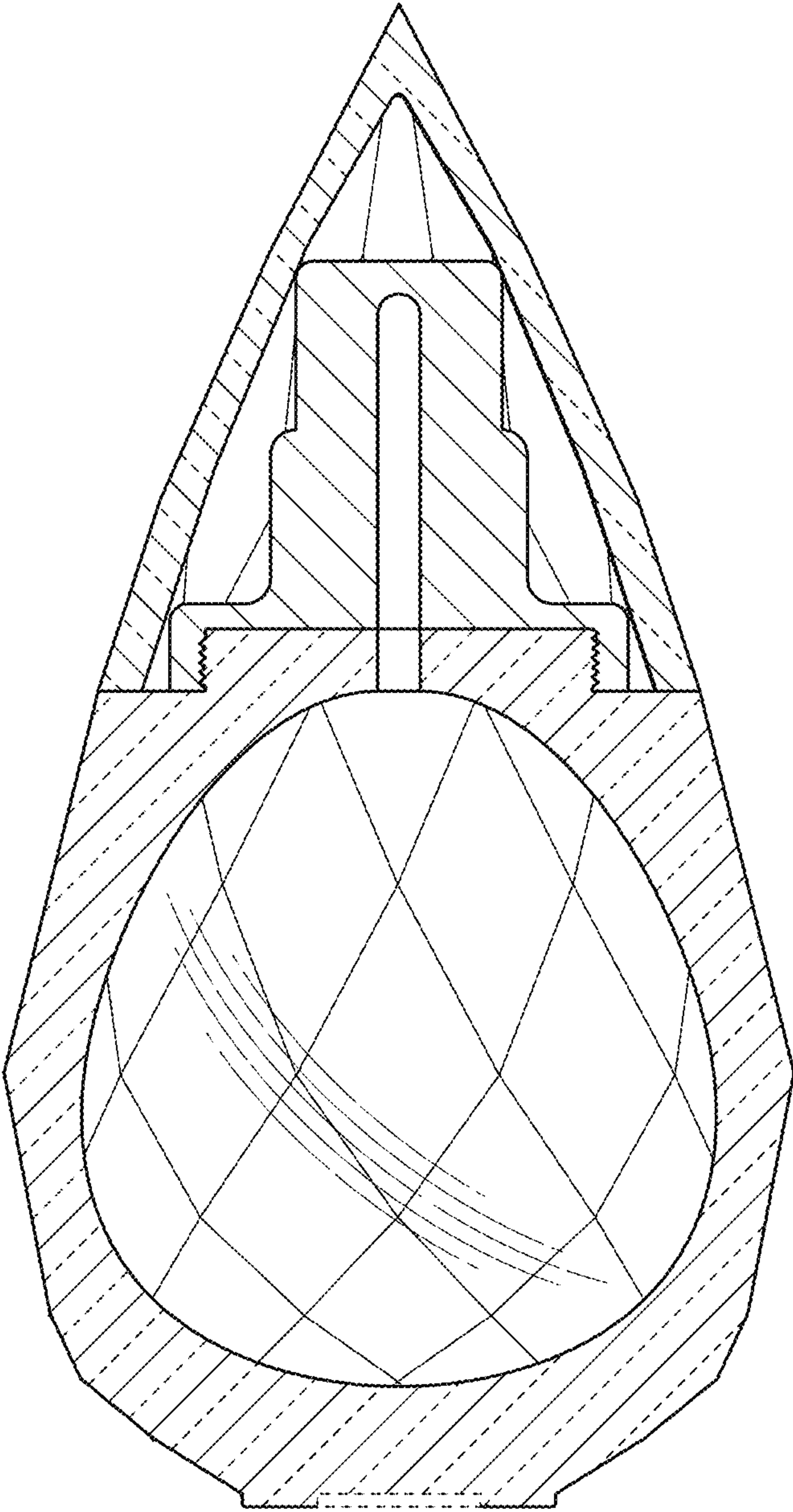

FIG. 7

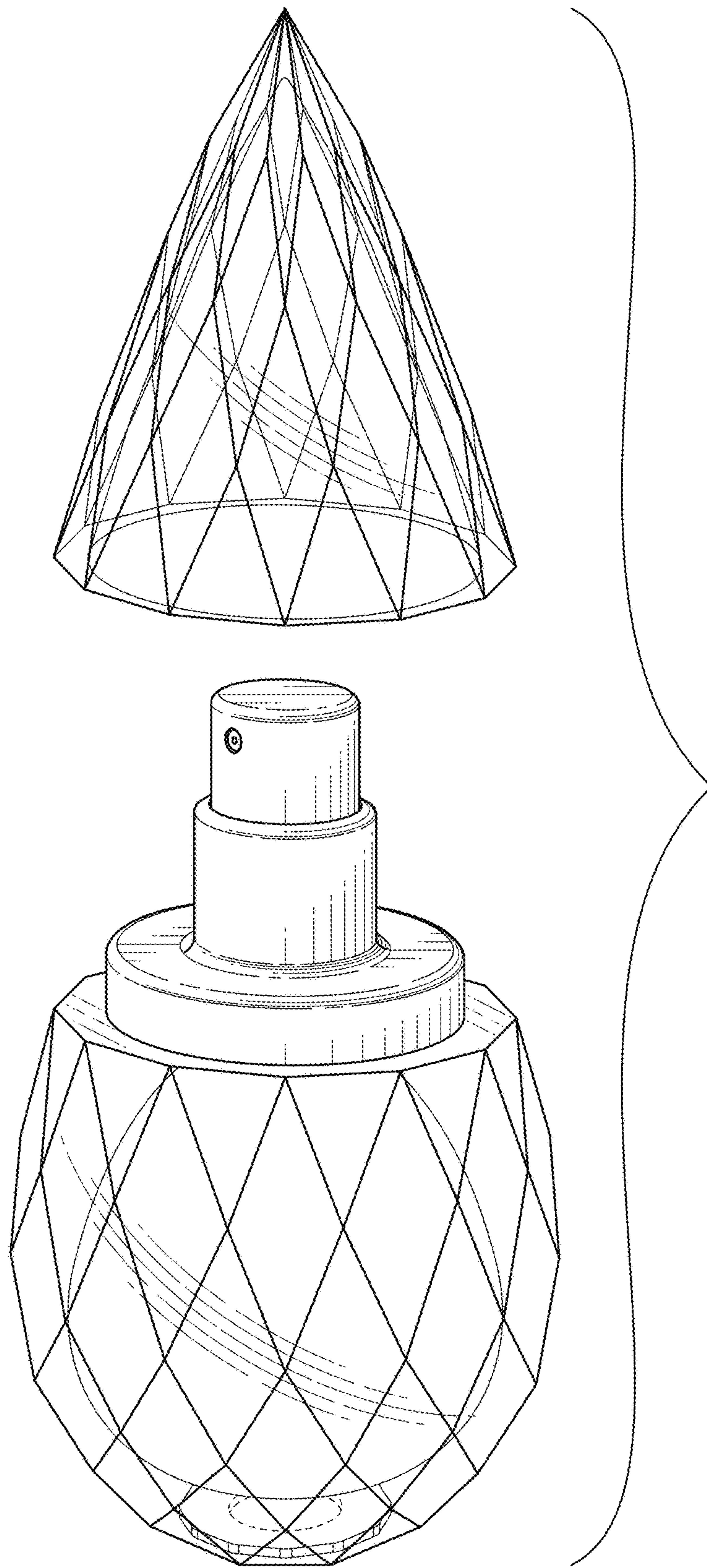

FIG. 8

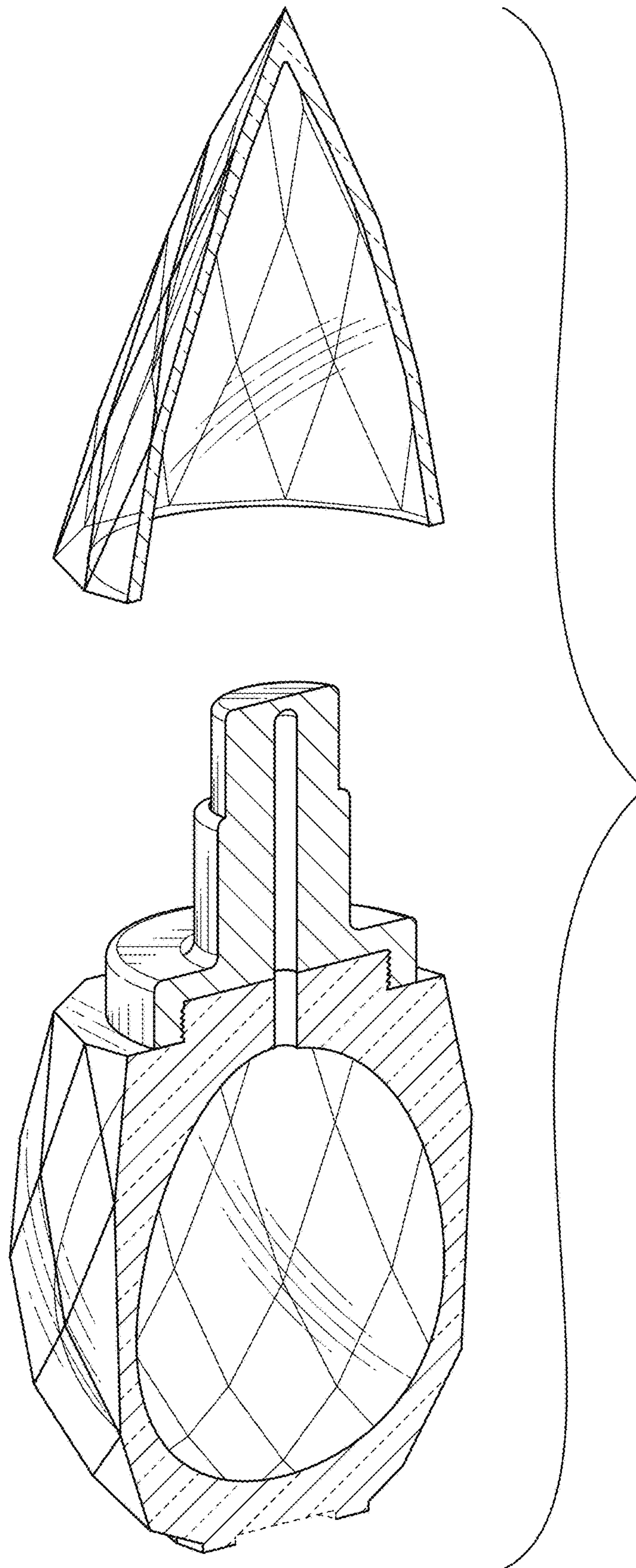

FIG. 9

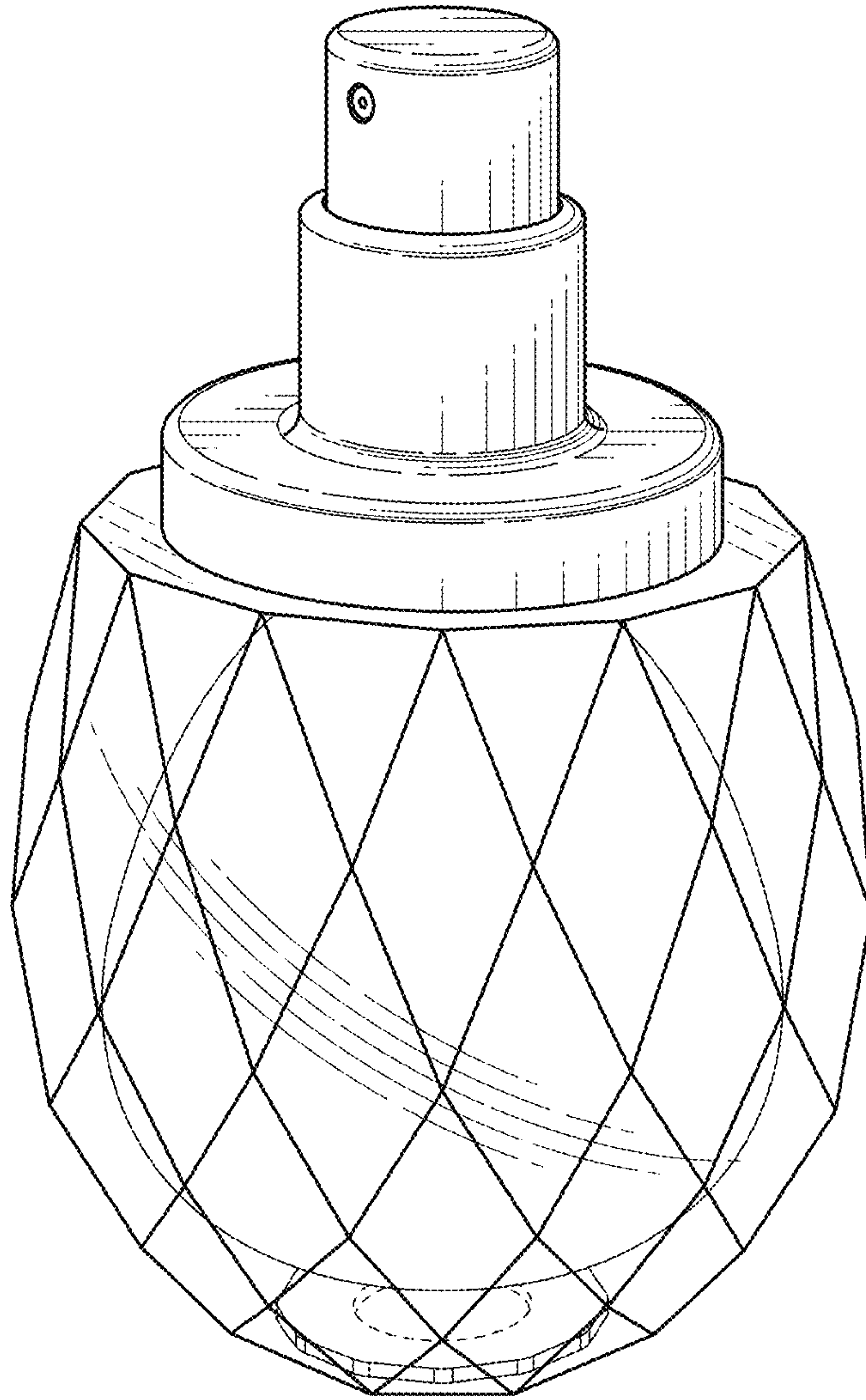

FIG. 10

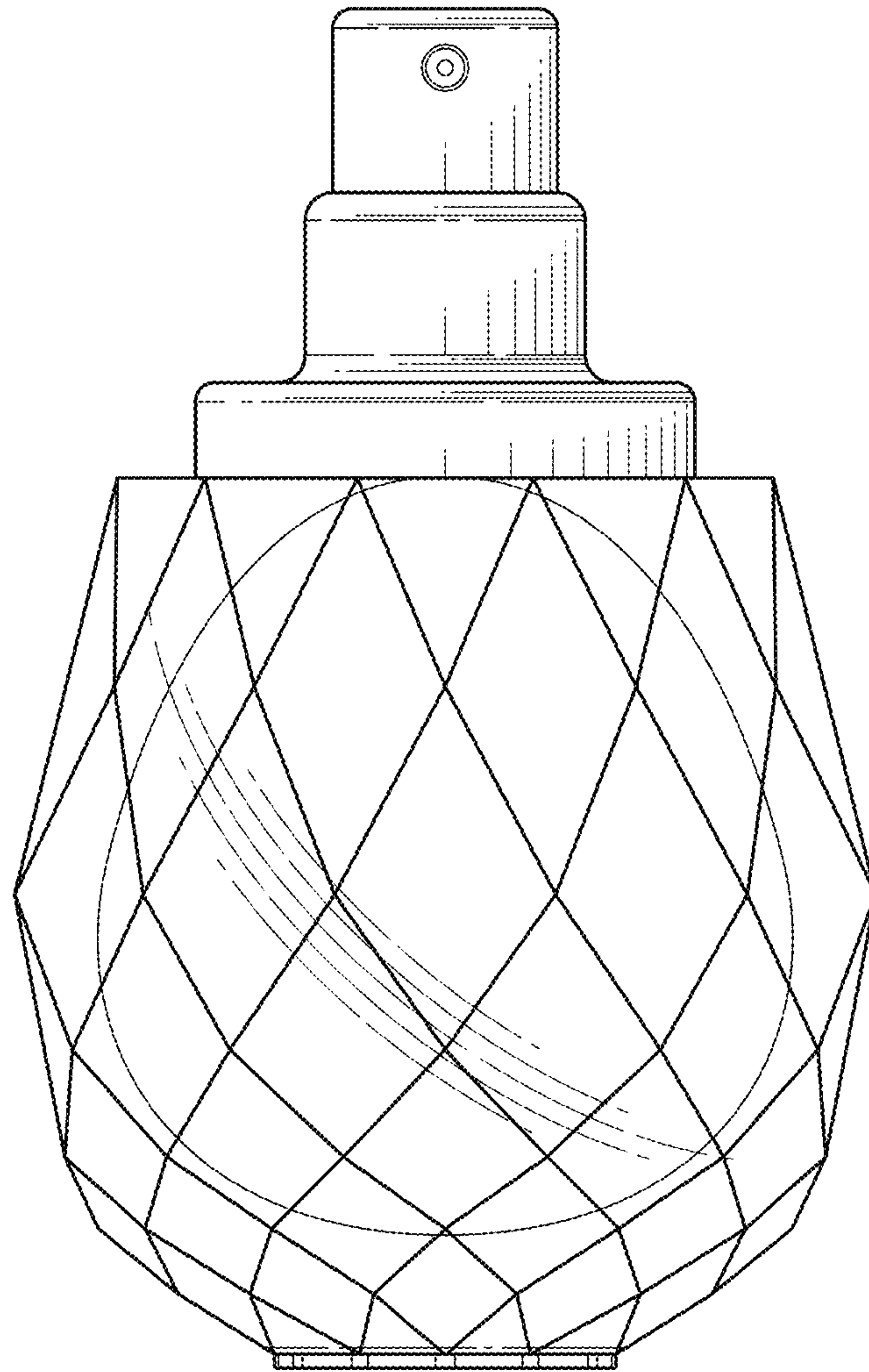

FIG. 11

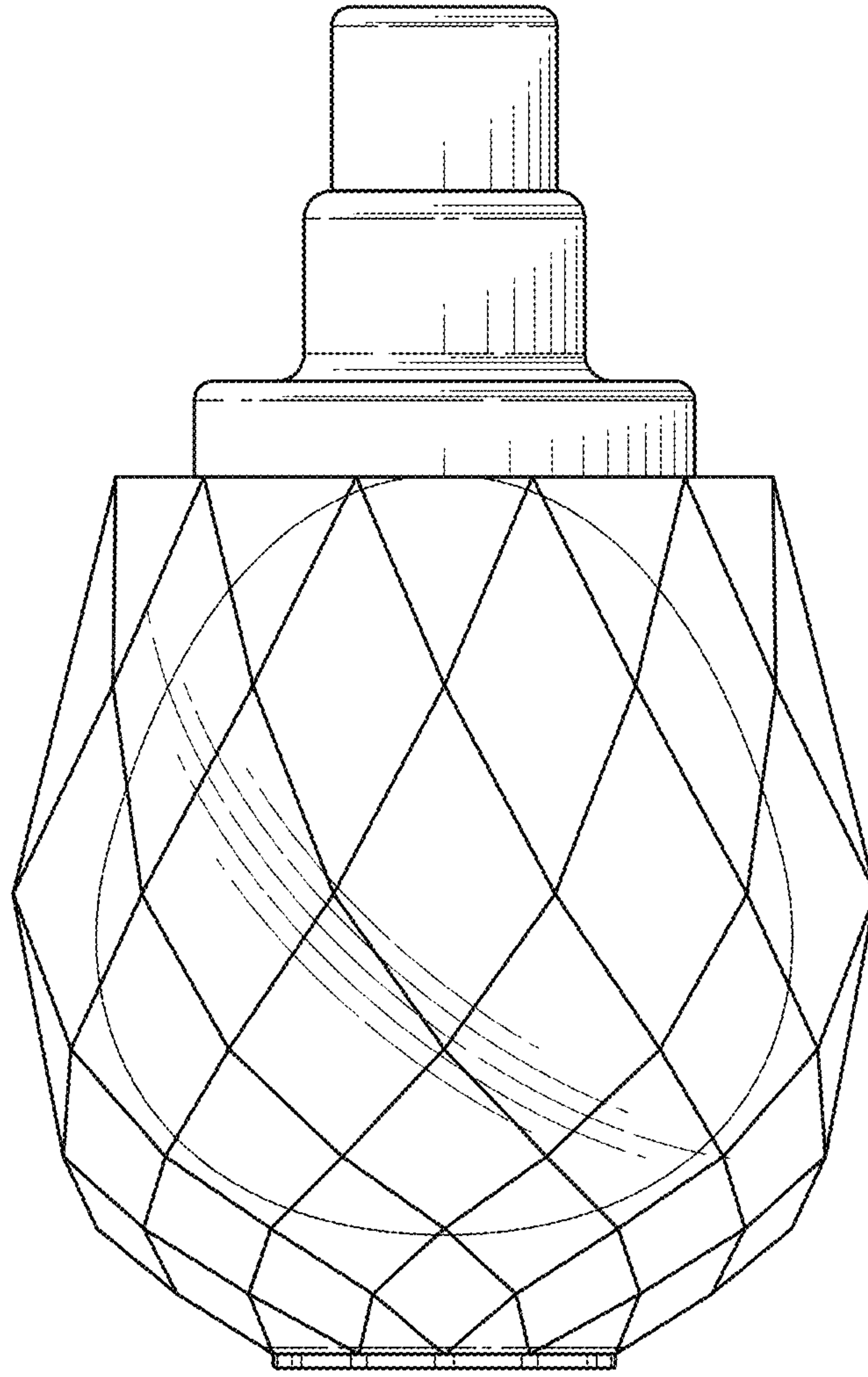

FIG. 12

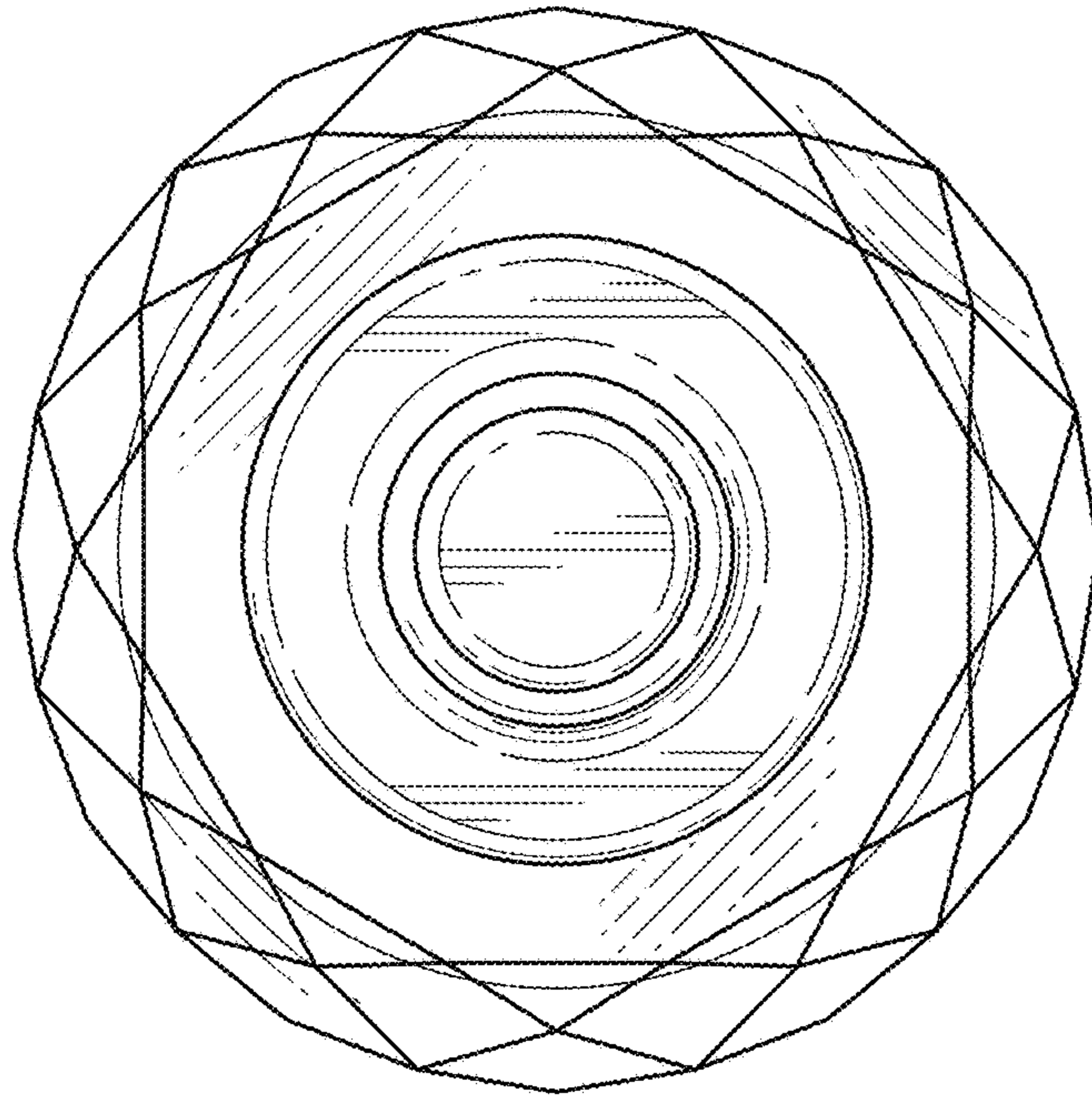

FIG. 13

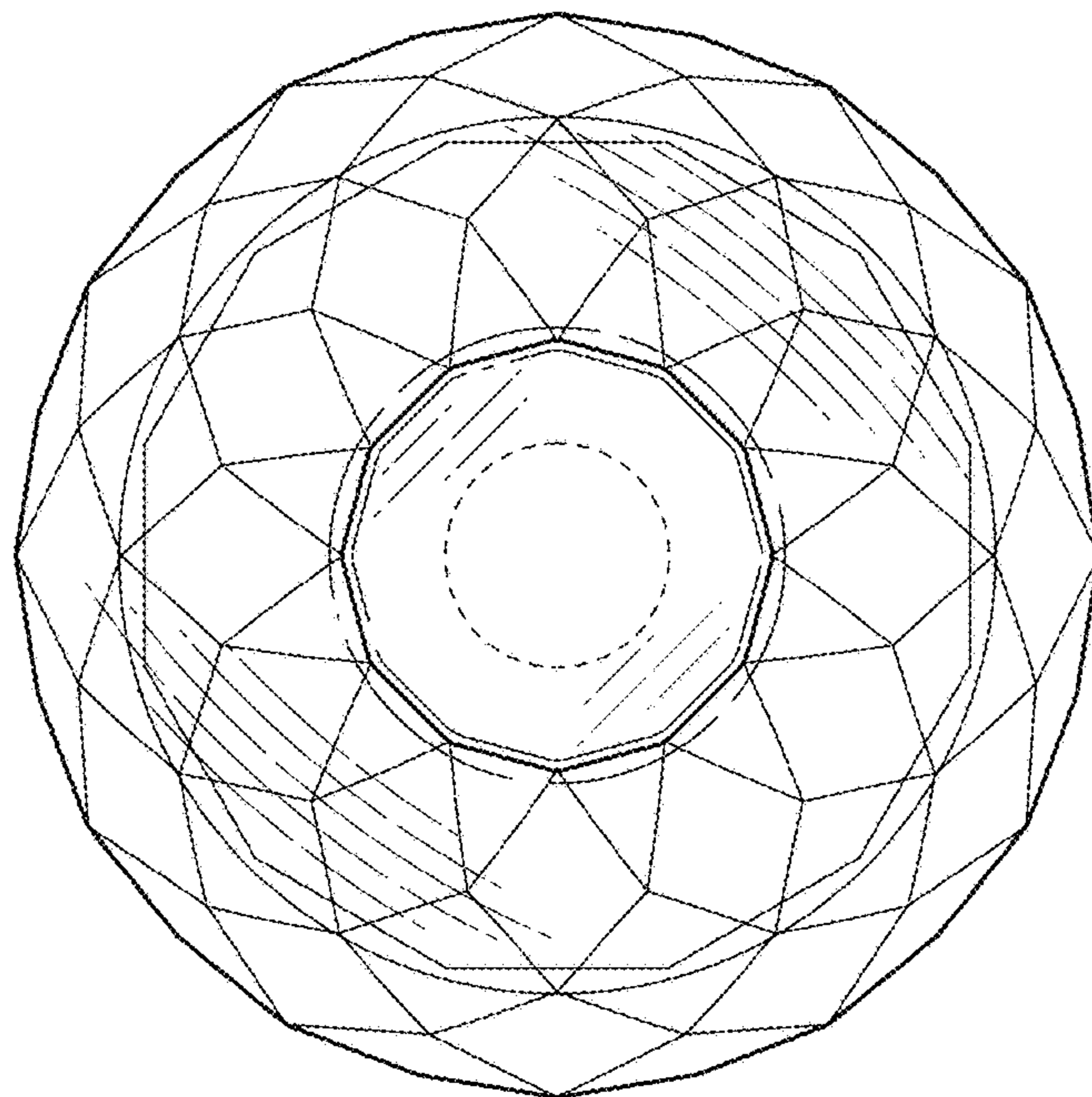

FIG. 14

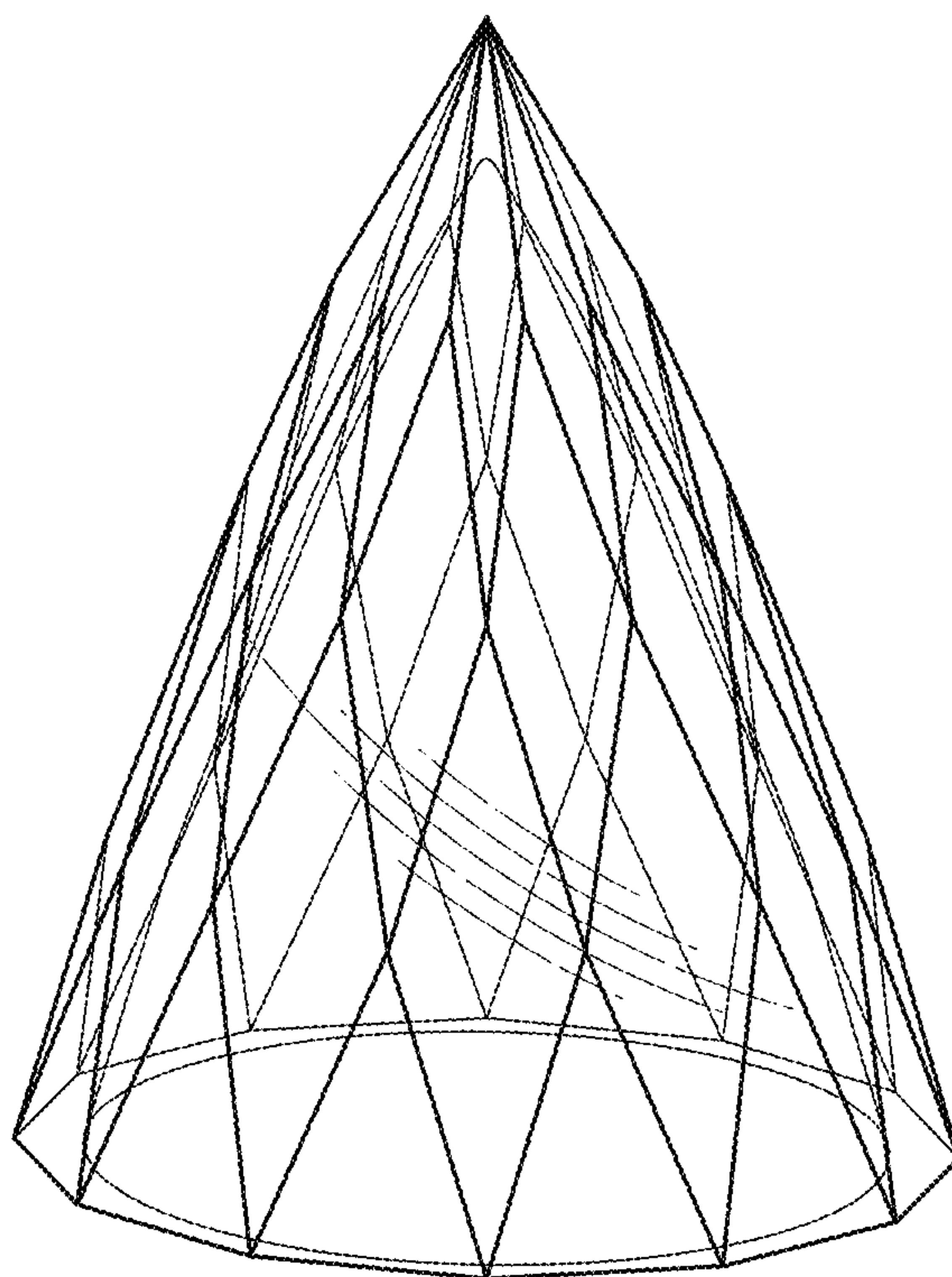

FIG. 15

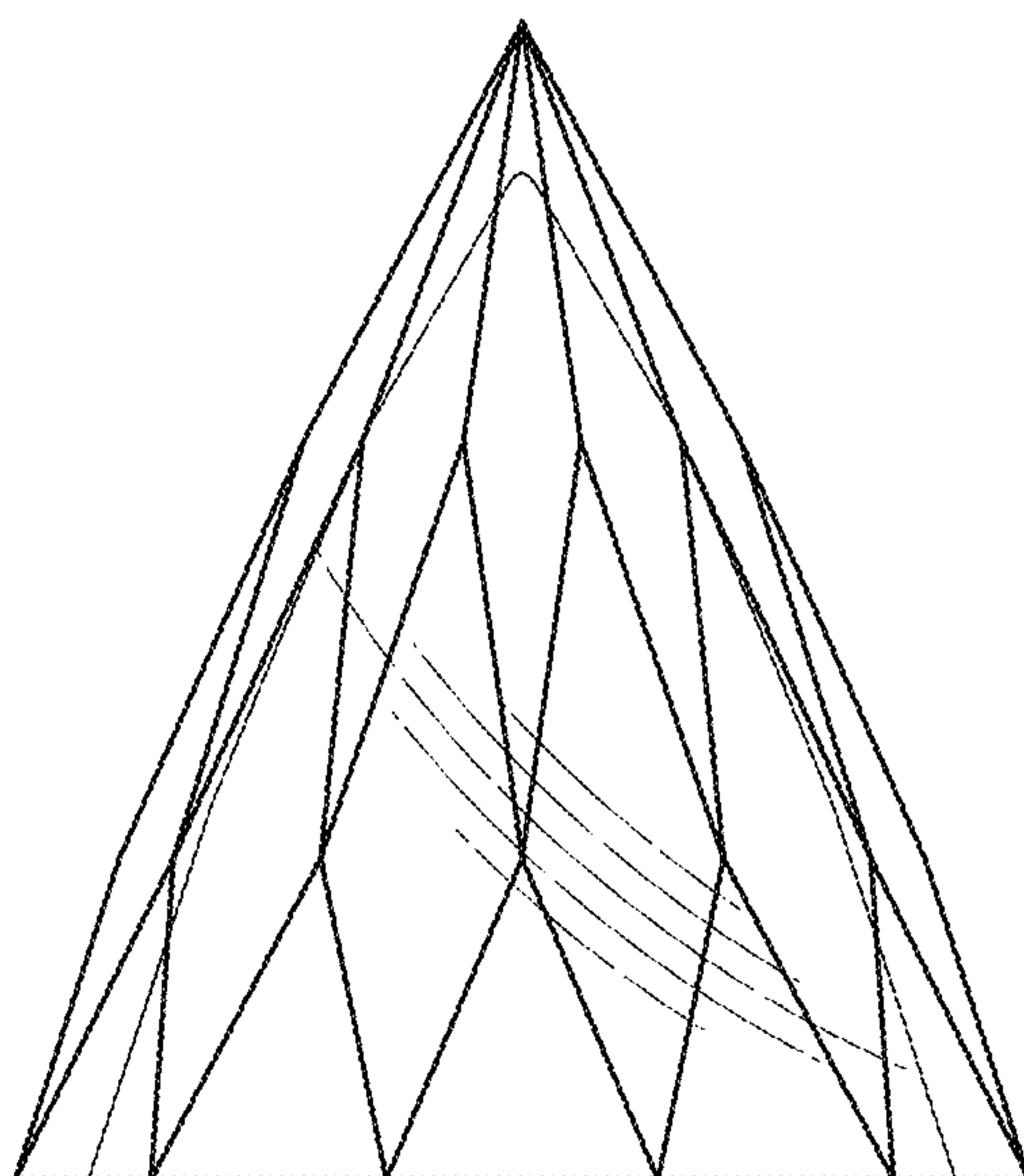

FIG. 16

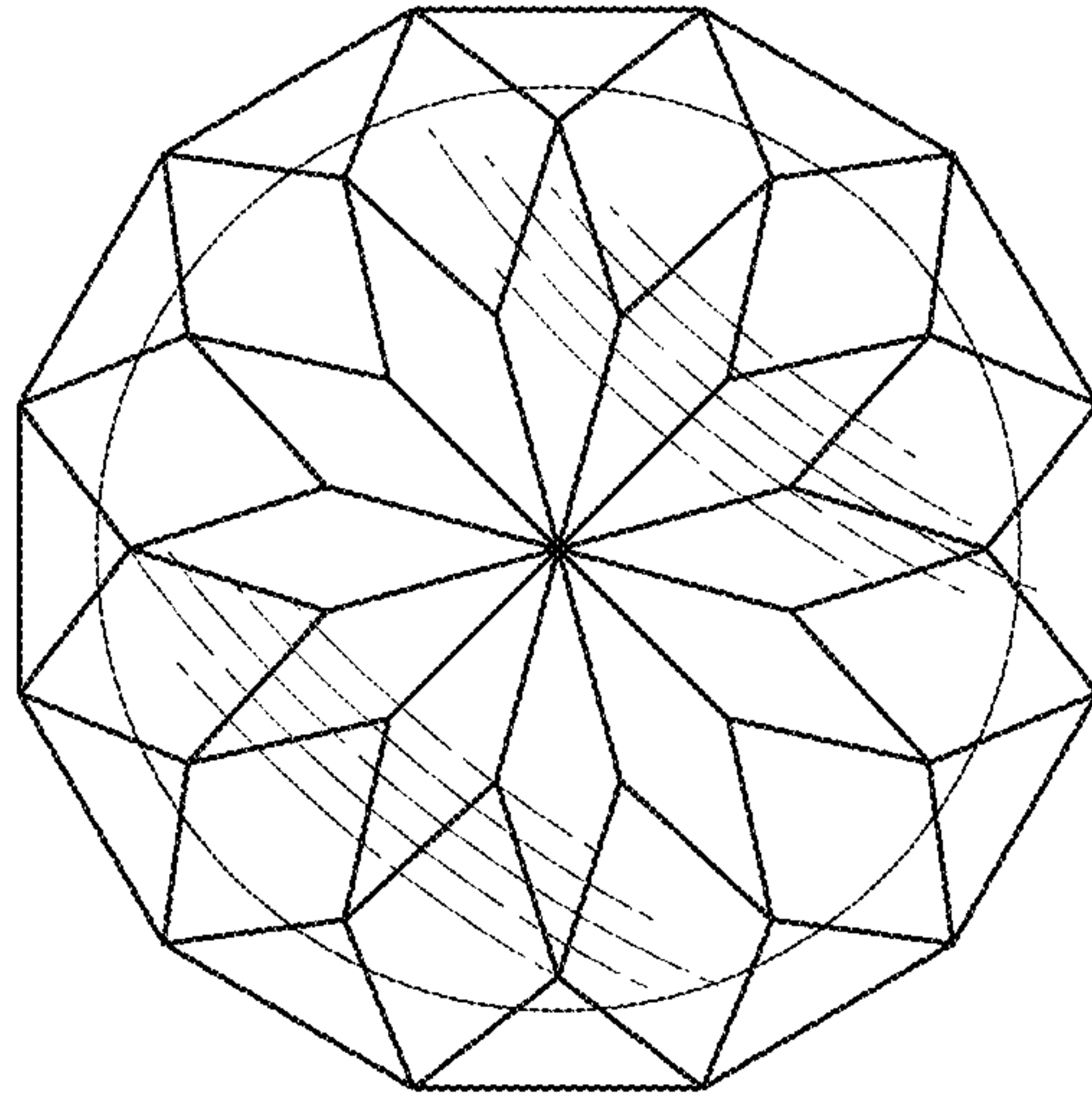

FIG. 17

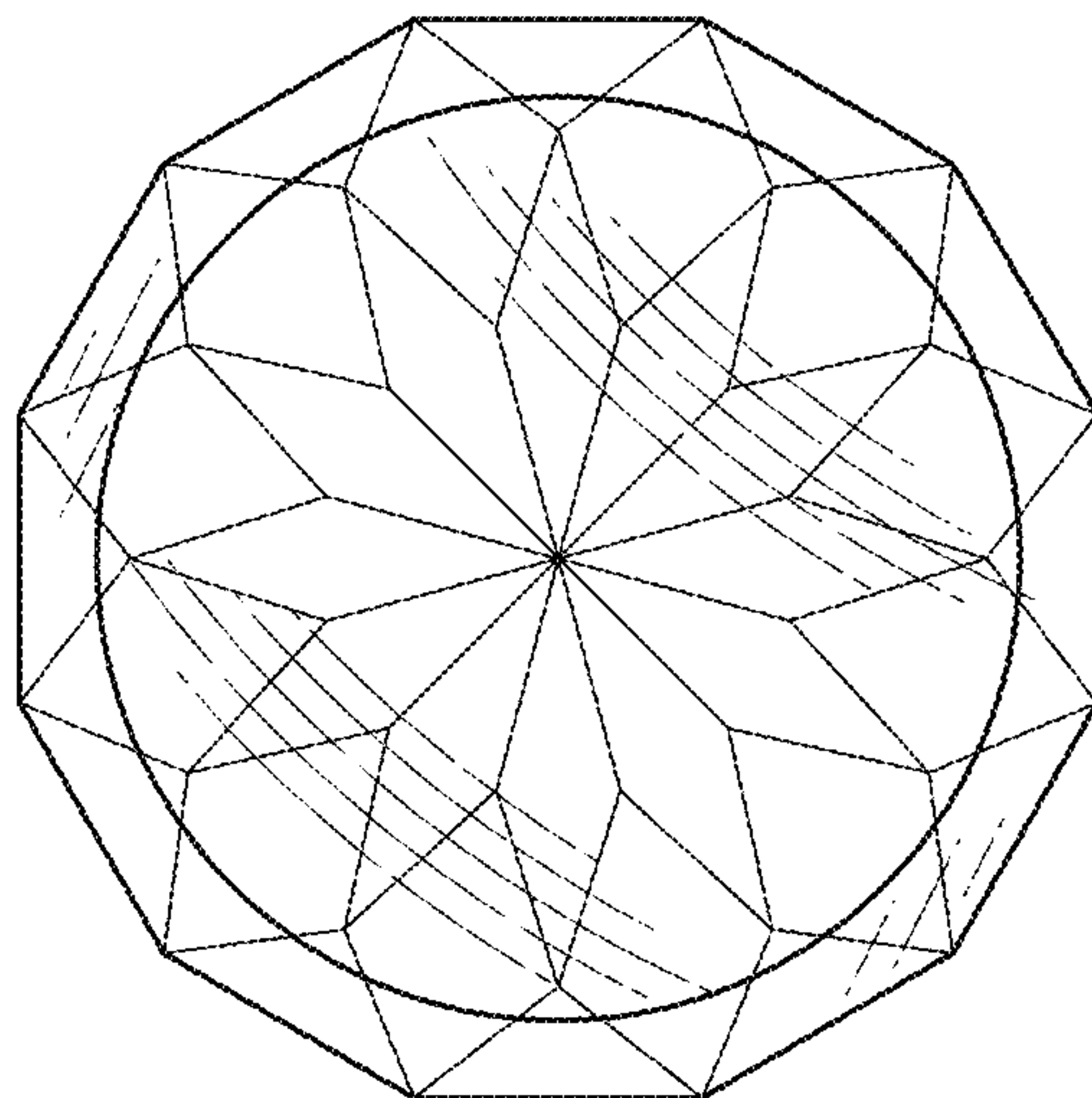

FIG. 18