



US00D778100S

(12) **United States Design Patent** (10) **Patent No.:** **US D778,100 S**  
**Kim et al.** (45) **Date of Patent:** **\*\* Feb. 7, 2017**

(54) **INDUCTION RANGE**  
(71) Applicant: **Samsung Electronics Co., Ltd.**,  
Suwon-si (KR)  
(72) Inventors: **Tai-Kyung Kim**, Seoul (KR); **Jae-Jun Kim**, Seoul (KR); **Sung-Hoon Cheung**,  
Seongnam-si (KR)  
(73) Assignee: **SAMSUNG ELECTRONICS CO., LTD.** (KR)

D511,925 S \* 11/2005 Baldwin ..... D7/340  
D530,971 S \* 10/2006 Kim ..... D7/340  
D553,900 S \* 10/2007 Grey ..... D7/346  
D557,549 S \* 12/2007 Grey ..... D7/346  
D560,957 S \* 2/2008 Grey ..... D7/346  
D563,715 S \* 3/2008 Grey ..... D7/346  
D568,673 S \* 5/2008 Tanaka ..... D7/346  
D609,960 S \* 2/2010 Cutino ..... D7/346  
D640,498 S \* 6/2011 Sadtler ..... D7/346  
D641,583 S \* 7/2011 Sadtler ..... D7/346  
D641,584 S \* 7/2011 Sadtler ..... D7/346  
D645,696 S \* 9/2011 Sadtler ..... D7/346

(Continued)

(\*\*) Term: **15 Years**

**FOREIGN PATENT DOCUMENTS**

(21) Appl. No.: **29/528,815**  
(22) Filed: **Jun. 1, 2015**  
(51) **LOC (10) Cl.** ..... **07-02**  
(52) **U.S. Cl.**  
USPC ..... **D7/346**  
(58) **Field of Classification Search**  
USPC ..... D7/323, 328-330, 339-349, 390,  
D7/402-409  
CPC ..... A21B 2/00; A47J 37/00; A47J 37/06;  
A47J 37/0611; A47J 37/08; A47J  
37/0807; A47J 37/0814; A47J 37/0835;  
A47J 37/0842; A47J 37/085; A47J  
37/0864; A47J 37/0878; A47J 37/0885;  
A47J 37/0892; C03C 17/38; F24C 7/00;  
F24C 7/002; F24C 7/046; F24C 7/067;  
F24C 15/02; F24C 15/04; F24C  
15/10; F24C 15/102  
See application file for complete search history.

KR 3020140041809 8/2014  
KR 300780879 1/2015

*Primary Examiner* — Ricky Pham  
(74) *Attorney, Agent, or Firm* — Cantor Colburn LLP

(57) **CLAIM**

The ornamental design for an induction range, as shown and described.

**DESCRIPTION**

FIG. 1 is a perspective view of an induction range, showing our new design;  
FIG. 2 is a front view thereof;  
FIG. 3 is a rear view thereof;  
FIG. 4 is a side view thereof;  
FIG. 5 is another side view thereof;  
FIG. 6 is a top view thereof;  
FIG. 7 is a bottom view thereof; and,  
FIG. 8 is an enlarged view of Section 8, as shown in FIG. 6. The broken lines in the figures are for environmental purposes only and form no part of the claimed design. The dash dot line shown in FIG. 6 forms no part of the claimed design, but is instead intended to identify the area of the enlarged view shown FIG. 8.

(56) **References Cited**  
U.S. PATENT DOCUMENTS

D386,945 S \* 12/1997 Mendoza ..... D7/402  
D506,637 S \* 6/2005 Tanaka ..... D7/346  
D508,630 S \* 8/2005 Grutzke ..... D7/346  
D508,816 S \* 8/2005 Tanaka ..... D7/346

**1 Claim, 8 Drawing Sheets**

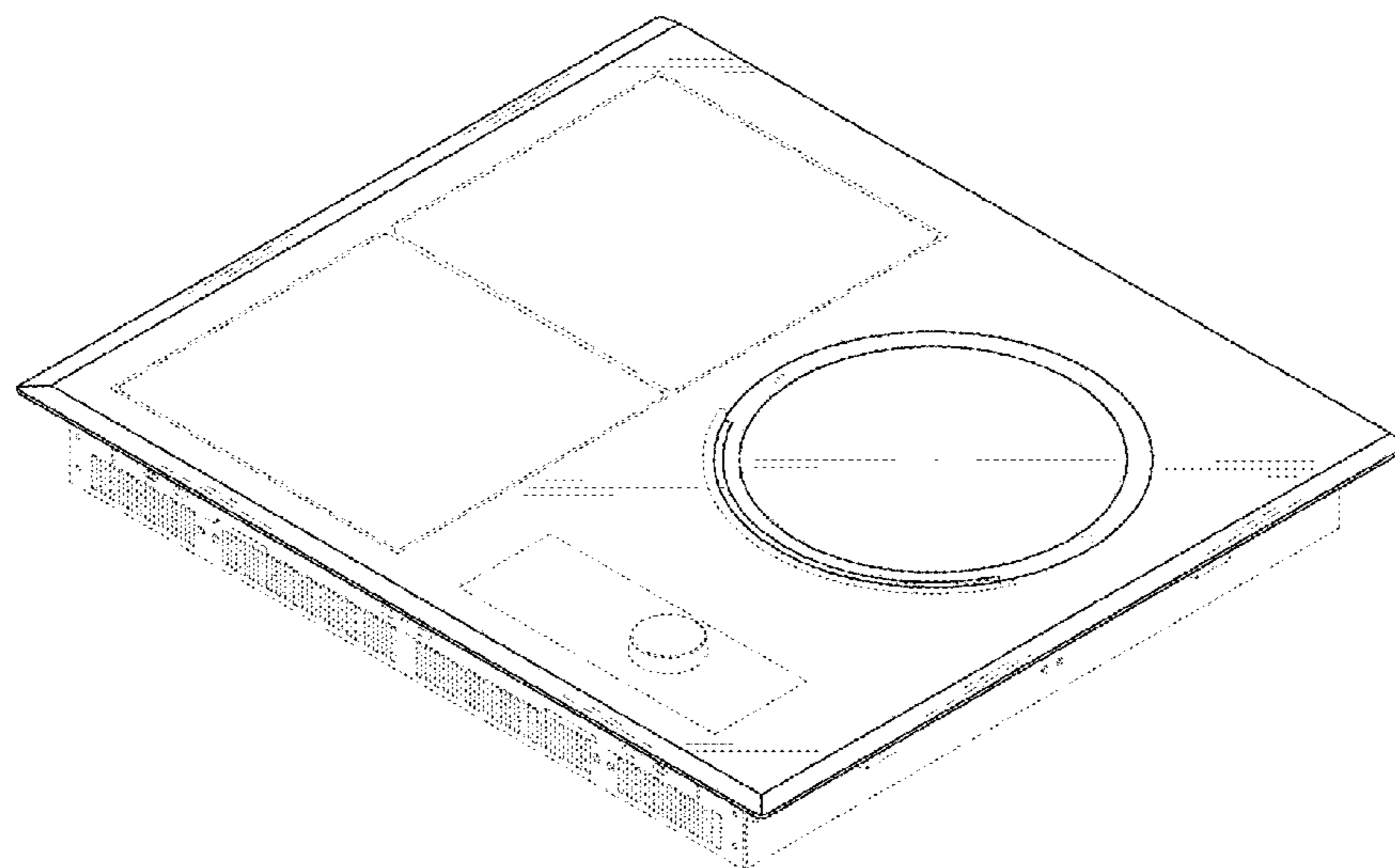

(56)

**References Cited**

U.S. PATENT DOCUMENTS

D671,789	S	*	12/2012	Goss	.....	D7/346
D694,569	S	*	12/2013	Sosso	.....	D7/346
D696,893	S	*	1/2014	Meda	.....	D7/346
D696,894	S	*	1/2014	Meda	.....	D7/346
D705,009	S	*	5/2014	Kwack	.....	D7/346
D715,592	S	*	10/2014	Yoon	.....	D7/407
D733,484	S	*	7/2015	Roberson	.....	D7/346
D754,465	S	*	4/2016	Kim	.....	D7/346
D764,219	S	*	8/2016	Kim	.....	D7/339
2008/0190409	A1	*	8/2008	Demol	.....	C03C 17/38 126/211

\* cited by examiner

FIG. 1

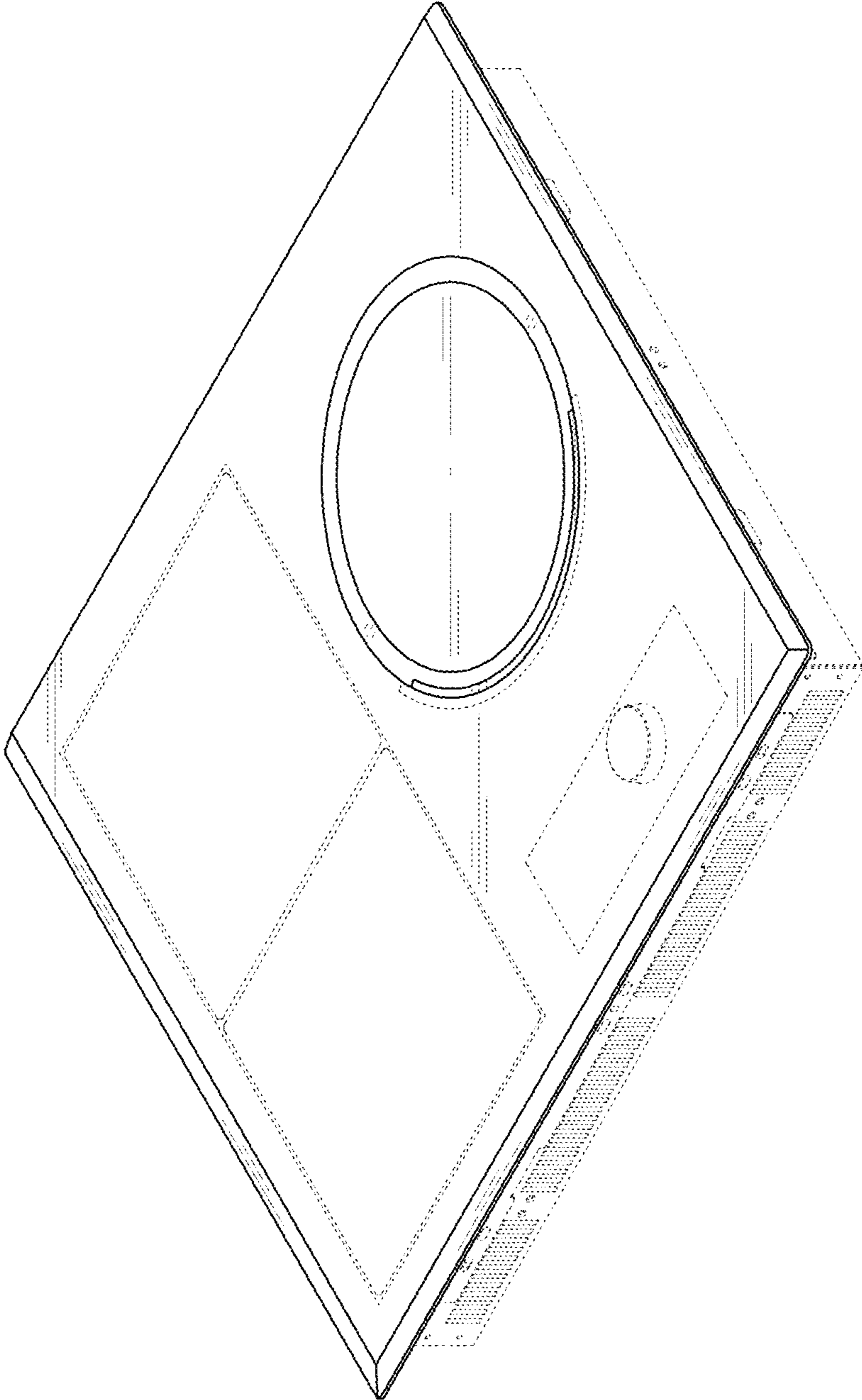

FIG. 2

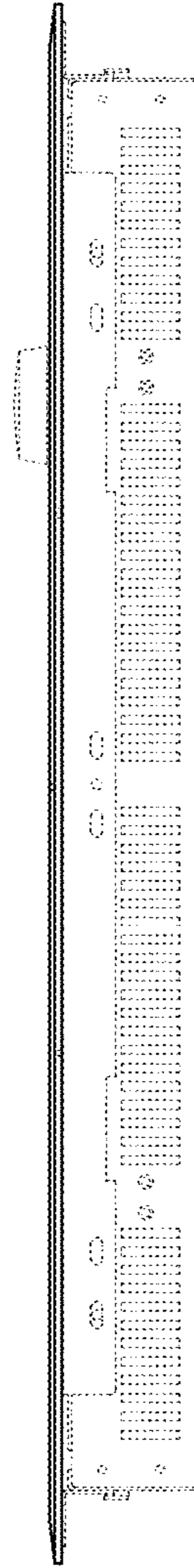

FIG. 3

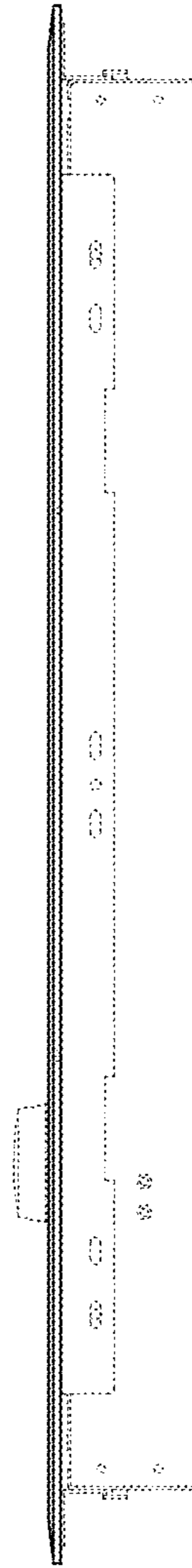

FIG. 4

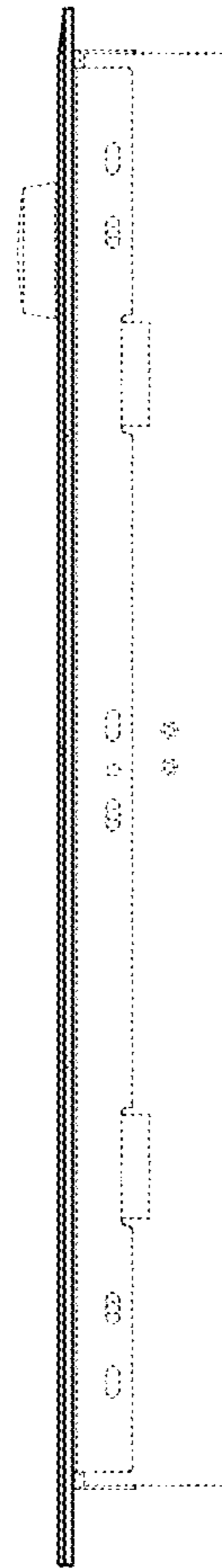
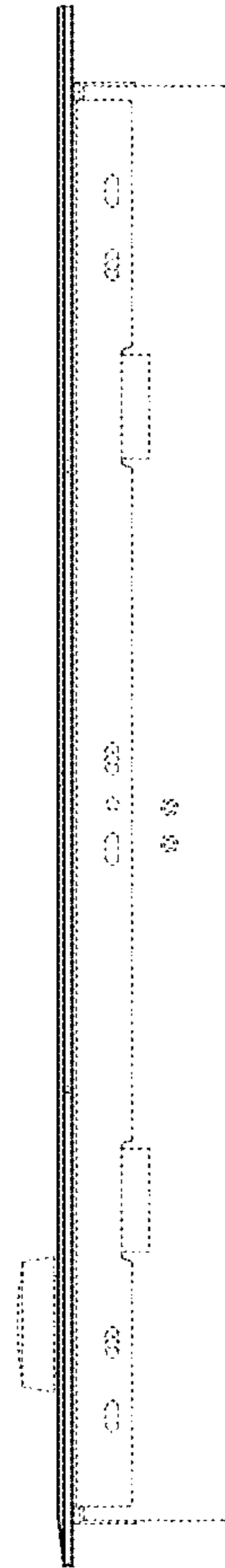

FIG. 5



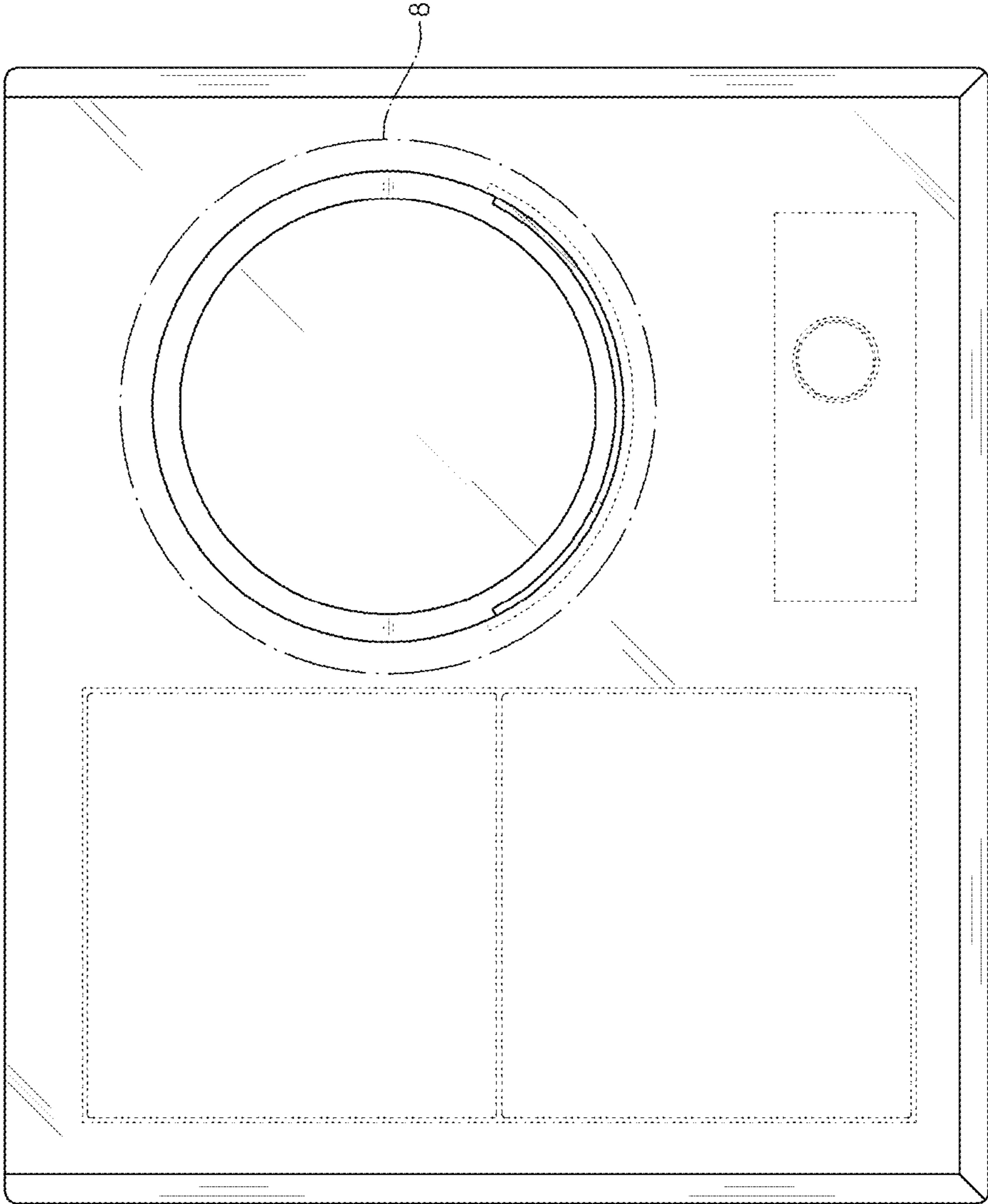

FIG. 6



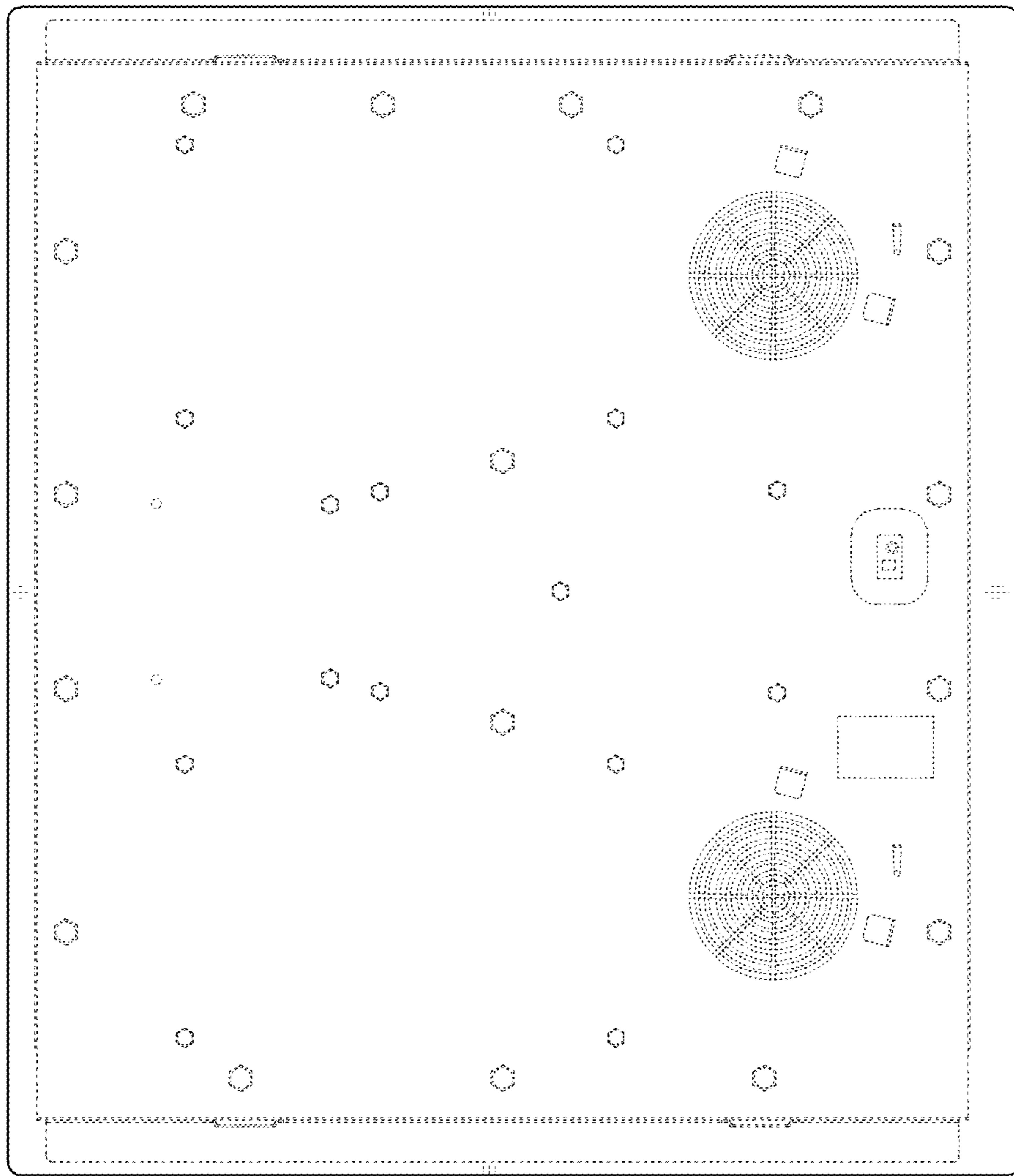

FIG. 7

FIG. 8

