



US00D778059S

(12) **United States Design Patent** (10) **Patent No.:** **US D778,059 S**
Sedic (45) **Date of Patent:** **** Feb. 7, 2017**

(54) **TONGUE CLEANER**
(71) Applicant: **Filip Sedic**, Stockholm (SE)
(72) Inventor: **Filip Sedic**, Stockholm (SE)
(**) Term: **15 Years**
(21) Appl. No.: **29/568,119**
(22) Filed: **Jun. 15, 2016**

Related U.S. Application Data

(62) Division of application No. 29/535,198, filed on Aug. 4, 2015.
(51) **LOC (10) Cl.** **28-03**
(52) **U.S. Cl.**
USPC **D4/101; D4/113**
(58) **Field of Classification Search**
USPC ... D4/101, 104–112, 113, 132–134; 15/22.1, 15/59.1, 167.1, 401, 105, 106; 132/309; 433/216; D24/146, 147, 149; 606/161
CPC A46B 2200/1066; A46B 15/0071; A46B 15/0002; A46B 5/02; A46B 15/0055; A46D 1/00; A45D 44/18; A61C 19/066; A61B 17/244
See application file for complete search history.

(56) **References Cited**

U.S. PATENT DOCUMENTS

2,218,072 A * 10/1940 Runnels A61B 17/244 15/110
2,583,750 A * 1/1952 Runnels A61B 17/244 15/236.06
D237,187 S 10/1975 Fattaleh et al.
D237,188 S 10/1975 Fattaleh et al.
D246,878 S * 1/1978 Kitzis D24/139
D265,506 S * 7/1982 Finamore D24/147
D291,001 S * 7/1987 Gaskins D24/147
D294,885 S * 3/1988 Mollenhoff 15/23

D295,695 S * 5/1988 Golzari D24/149
D301,372 S * 5/1989 Tsen D24/147
D324,912 S * 3/1992 Hansen D24/146
D367,707 S * 3/1996 Baker D24/146
D378,411 S * 3/1997 Taoatao D24/147
D385,962 S * 11/1997 Conrey D24/147
D391,370 S * 2/1998 Cho D24/147
D392,386 S * 3/1998 Nguyen D24/147
5,779,475 A * 7/1998 Patel A46B 15/00 15/236.08
5,792,159 A * 8/1998 Amin A61B 17/244 15/236.06
D402,811 S * 12/1998 Stansbury, Jr. D4/101
D404,487 S * 1/1999 Bertella D24/147
D406,891 S * 3/1999 Smith D24/147
D408,534 S * 4/1999 Jansheski D24/147
5,893,860 A * 4/1999 Ripich A61B 17/244 606/161
5,947,912 A * 9/1999 Montagnino A61B 17/244 601/141

(Continued)

Primary Examiner — John Windmuller
Assistant Examiner — Steven Czyz
(74) *Attorney, Agent, or Firm* — Fenwick & West LLP

(57) **CLAIM**

I claim the ornamental design for a tongue cleaner, as shown and described.

DESCRIPTION

FIG. 1 is a perspective view of a tongue cleaner;
FIG. 2 is a front view thereof;
FIG. 3 is a back view thereof;
FIG. 4 is a right side view thereof;
FIG. 5 is a left side view thereof;
FIG. 6 is a top view thereof; and,
FIG. 7 is a bottom view thereof.
The broken lines depict portions of the article that form no part of the claimed design.

1 Claim, 7 Drawing Sheets

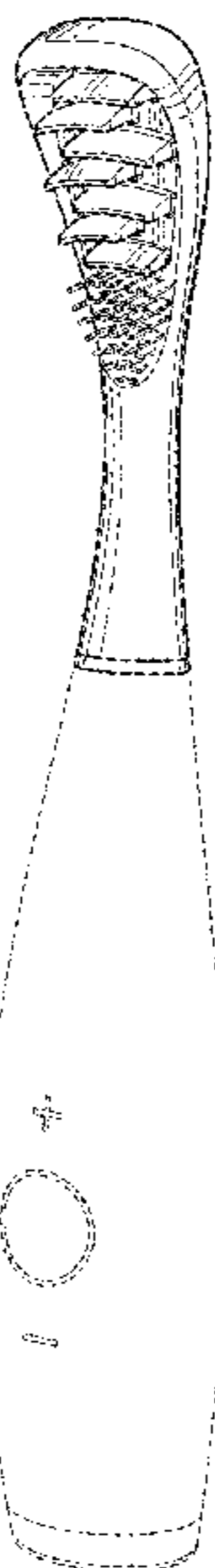

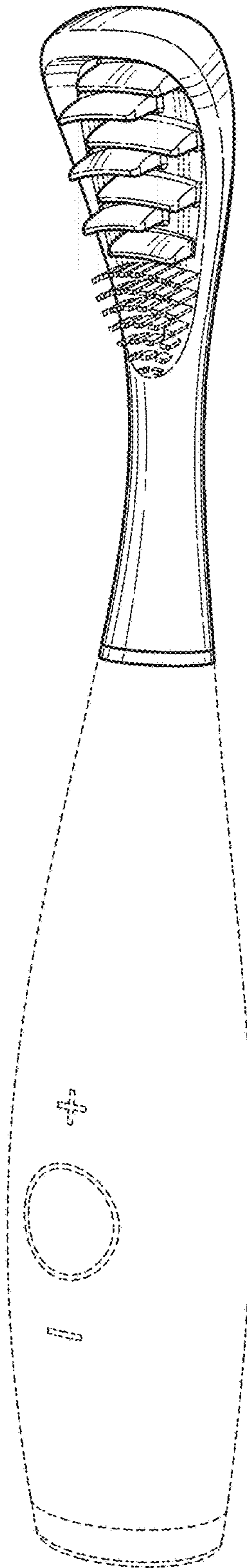

FIG. 1

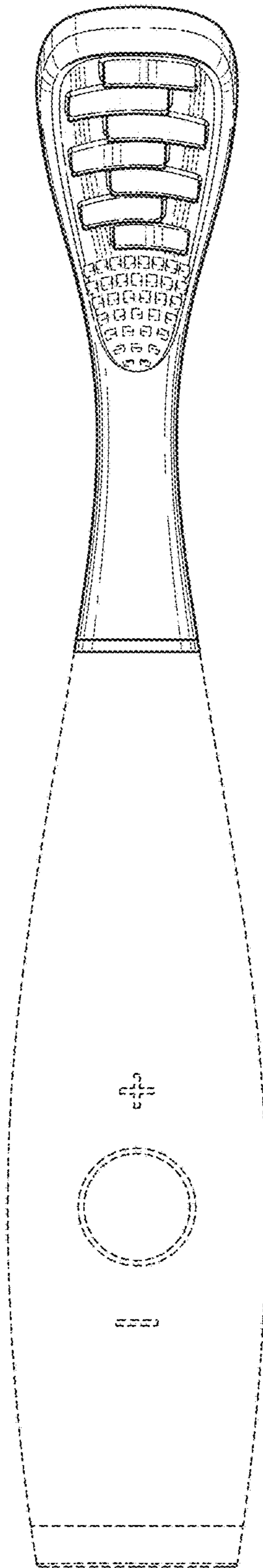

FIG. 2

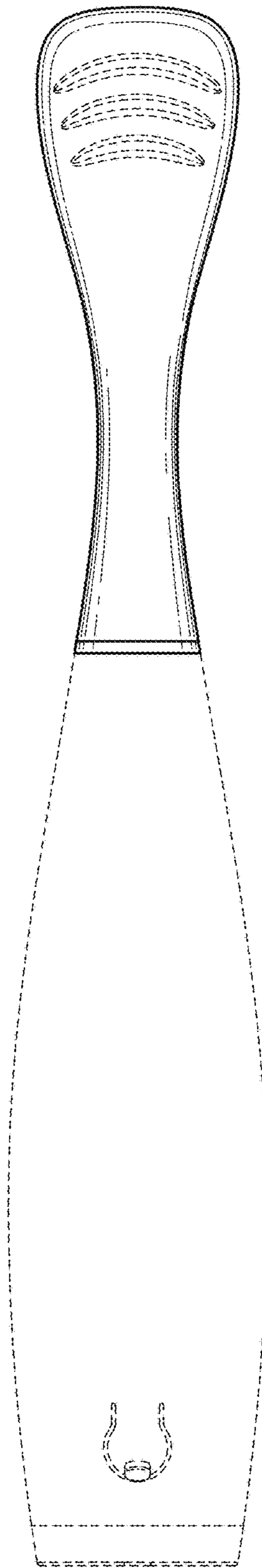

FIG. 3

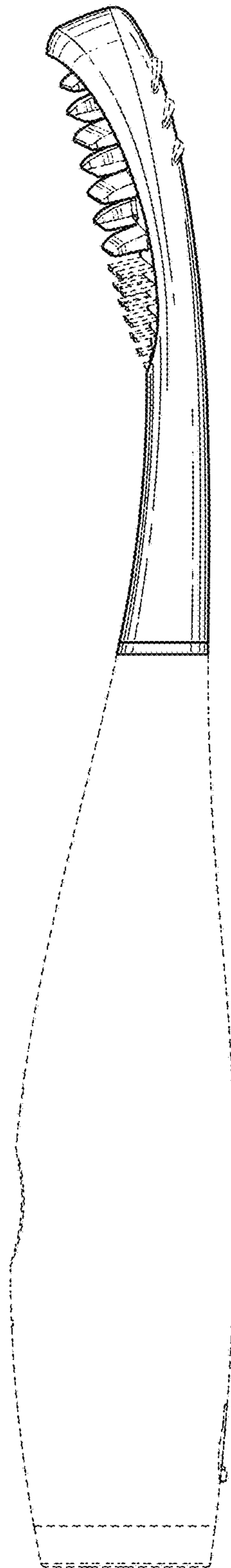

FIG. 4

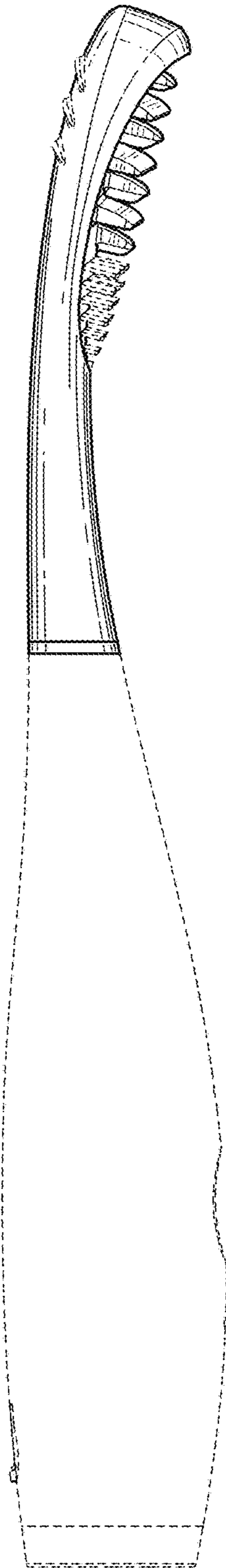

FIG. 5

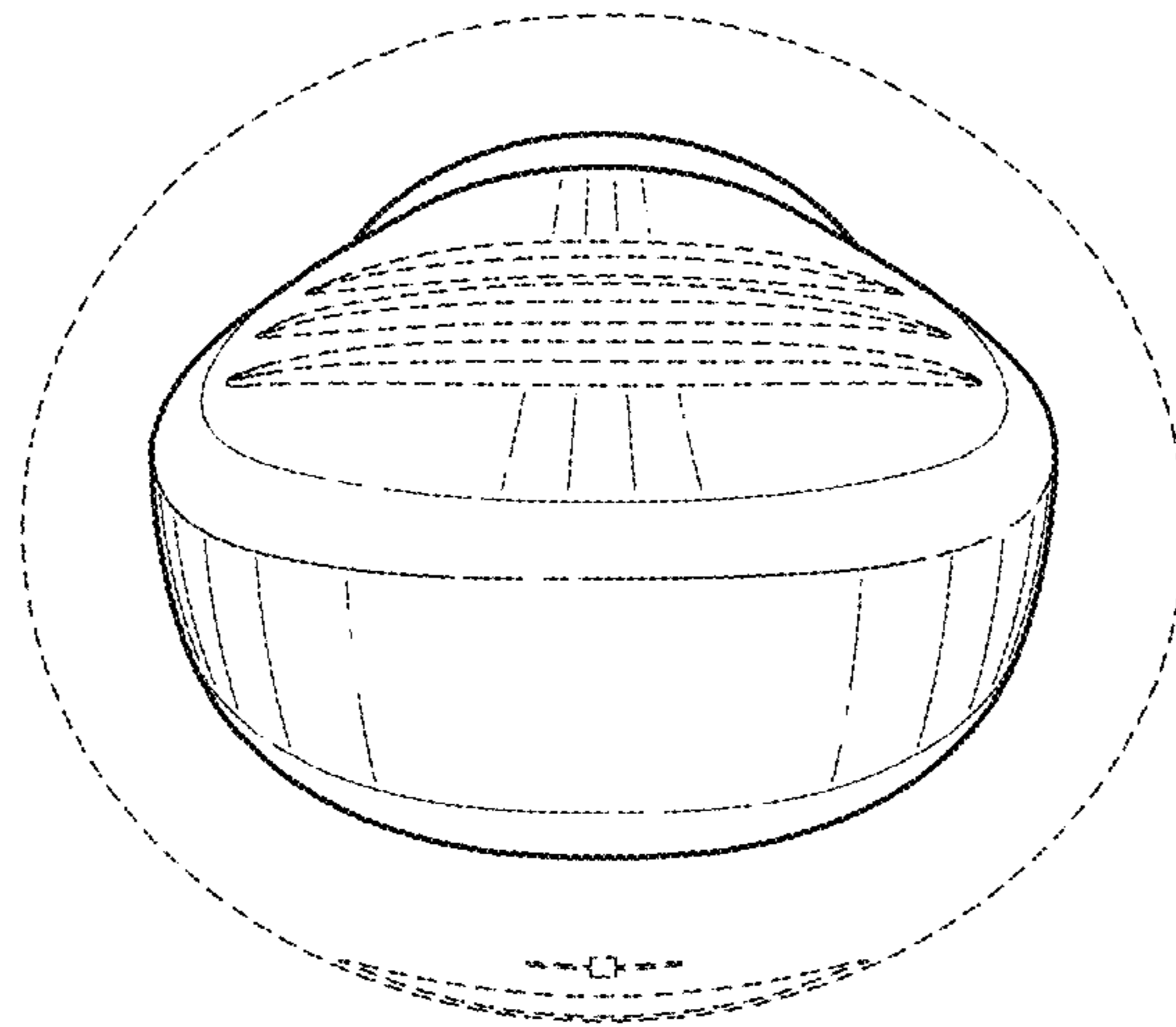

FIG. 6

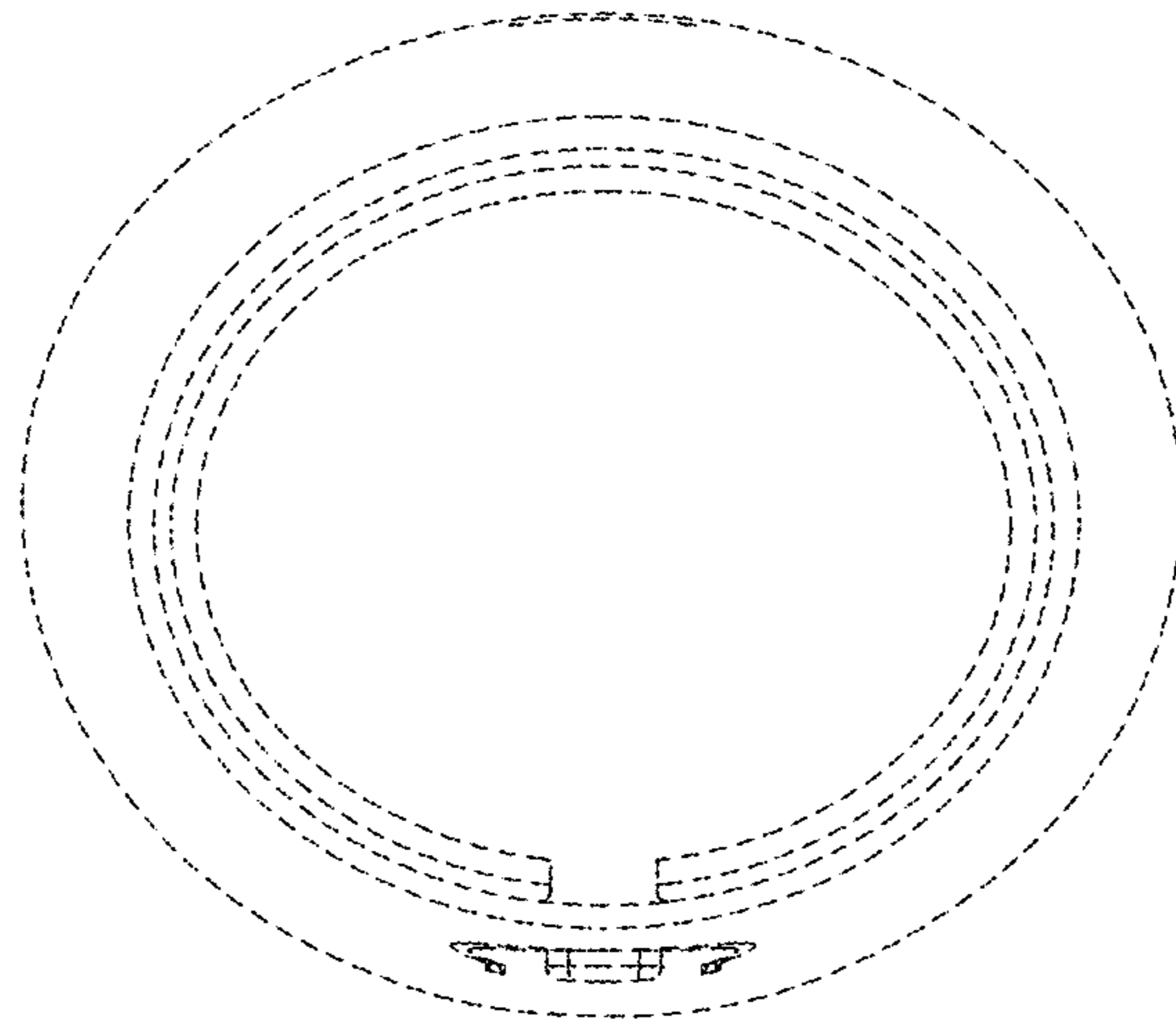

FIG. 7