



US00D778048S

(12) **United States Design Patent** (10) **Patent No.:** **US D778,048 S**
Jose (45) **Date of Patent:** **** Feb. 7, 2017**

(54) **COLLAPSIBLE SUITCASE IN COLLAPSED FORM**

(71) Applicant: **Boban Jose**, San Ramon, CA (US)

(72) Inventor: **Boban Jose**, San Ramon, CA (US)

(**) Term: **15 Years**

(21) Appl. No.: **29/528,510**

(22) Filed: **May 29, 2015**

(51) **LOC (10) Cl.** **03-01**

(52) **U.S. Cl.**
USPC **D3/273**

(58) **Field of Classification Search**
USPC D3/273, 285, 289
CPC A45C 5/02; A45C 5/14; A45C 7/00;
B65D 13/00

See application file for complete search history.

(56) **References Cited**

U.S. PATENT DOCUMENTS

6,604,617	B2 *	8/2003	Davis	A45C 5/02 190/107
7,232,018	B1 *	6/2007	Salander	A45C 5/14 190/103
D586,123	S *	2/2009	Lowrey	D3/273
7,500,547	B2 *	3/2009	Bettua	A45C 5/14 190/103
D651,794	S *	1/2012	Hargens	D3/232
D708,848	S *	7/2014	Zwetzig	D3/246

* cited by examiner

Primary Examiner — Holly Baynham
(74) *Attorney, Agent, or Firm* — Law Office of Ilya Libenzon

(57) **CLAIM**

What is claimed is the ornamental design for a collapsible suitcase in collapsed form, as shown and described.

DESCRIPTION

FIG. 1 is a perspective view of the suitcase according to the present invention;
FIG. 2 is a top view of the suitcase according to the present invention;
FIG. 3 is a bottom view of the suitcase according to the present invention;
FIG. 4 is a front view of the suitcase according to the present invention;
FIG. 5 is a rear view of the suitcase according to the present invention;
FIG. 6 is a side view of the suitcase according to the present invention; and,
FIG. 7 is a side view of the suitcase according to the present invention.
The broken lines showing portions of a suitcase are for the purposes of illustrating environment and form no part of the claimed design.

1 Claim, 7 Drawing Sheets

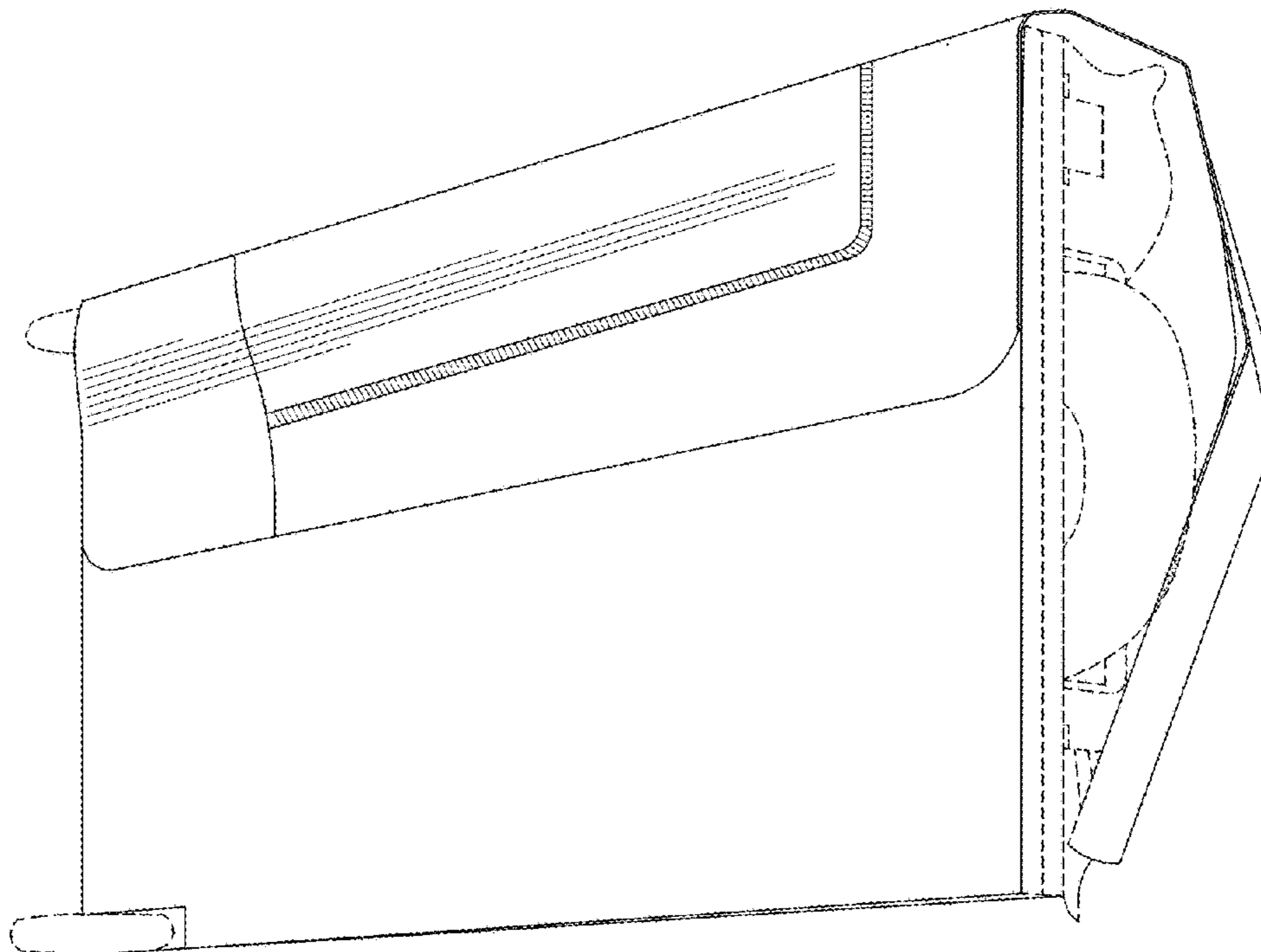

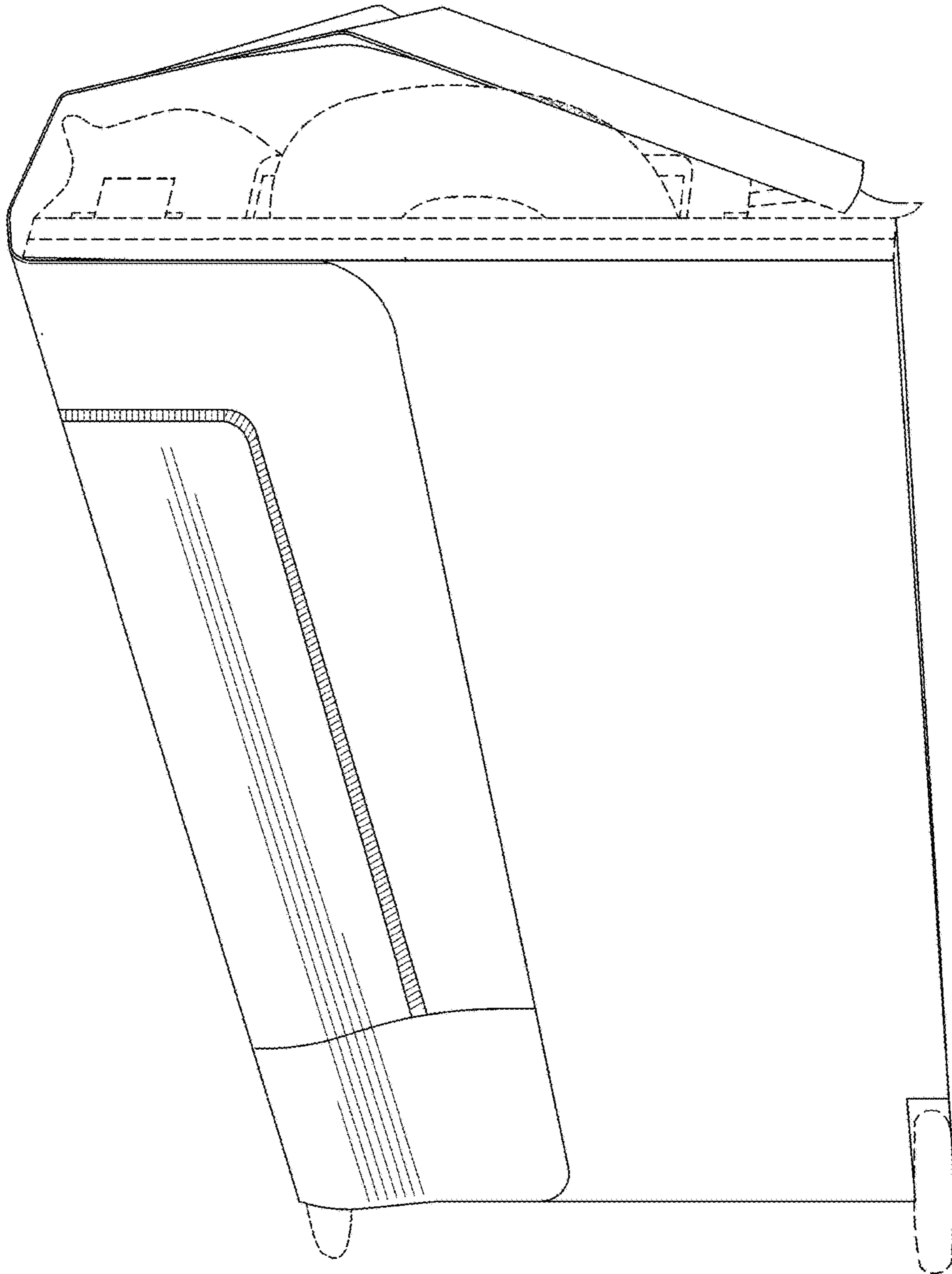

FIG. 1

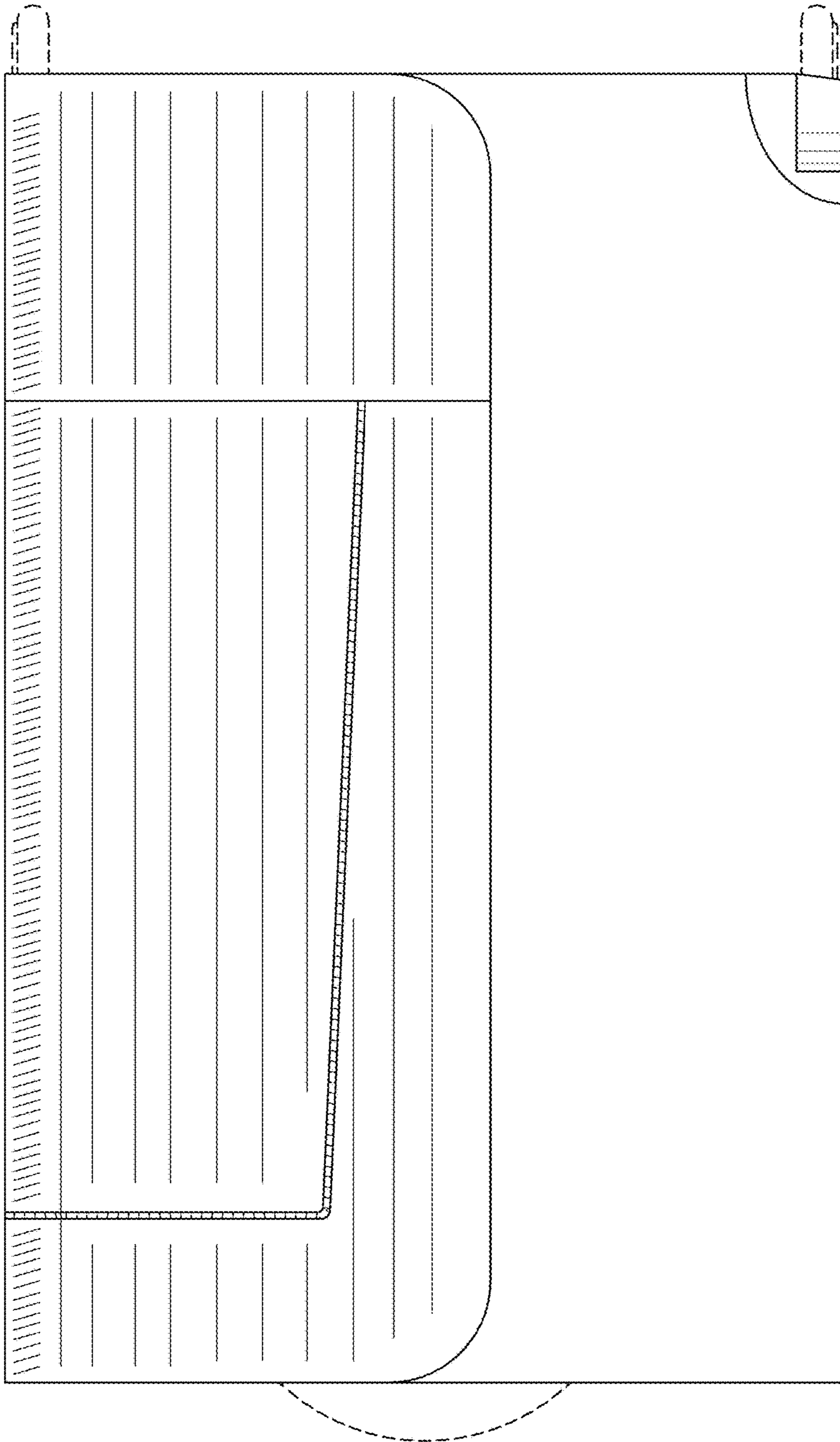

FIG. 2

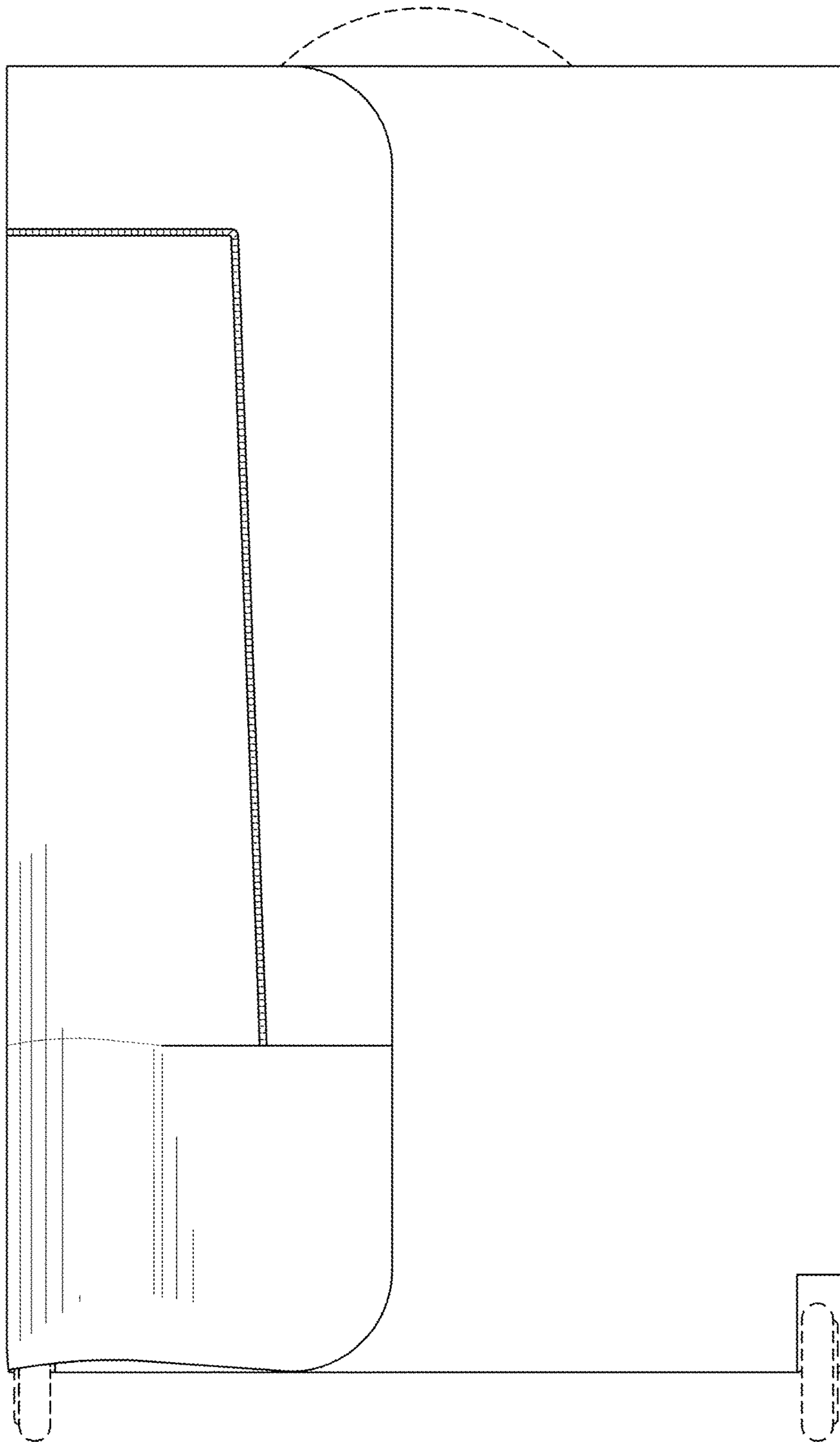

FIG. 3

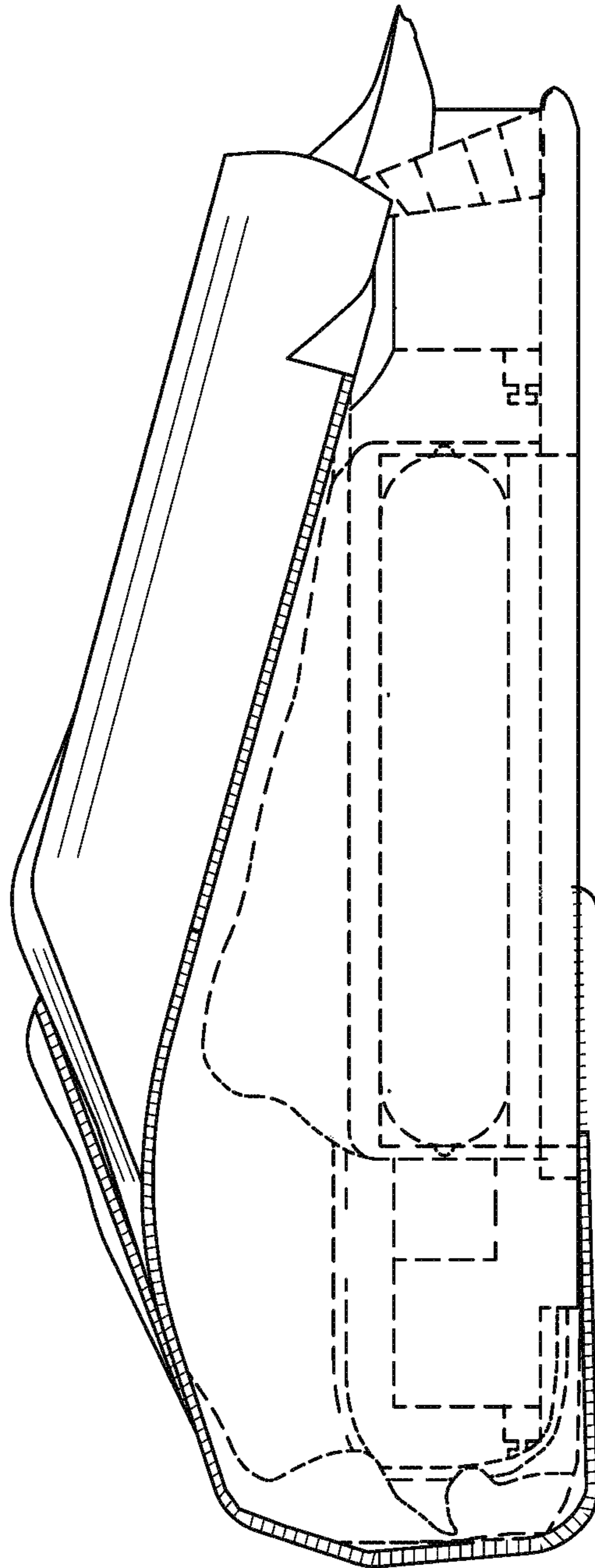

FIG. 4

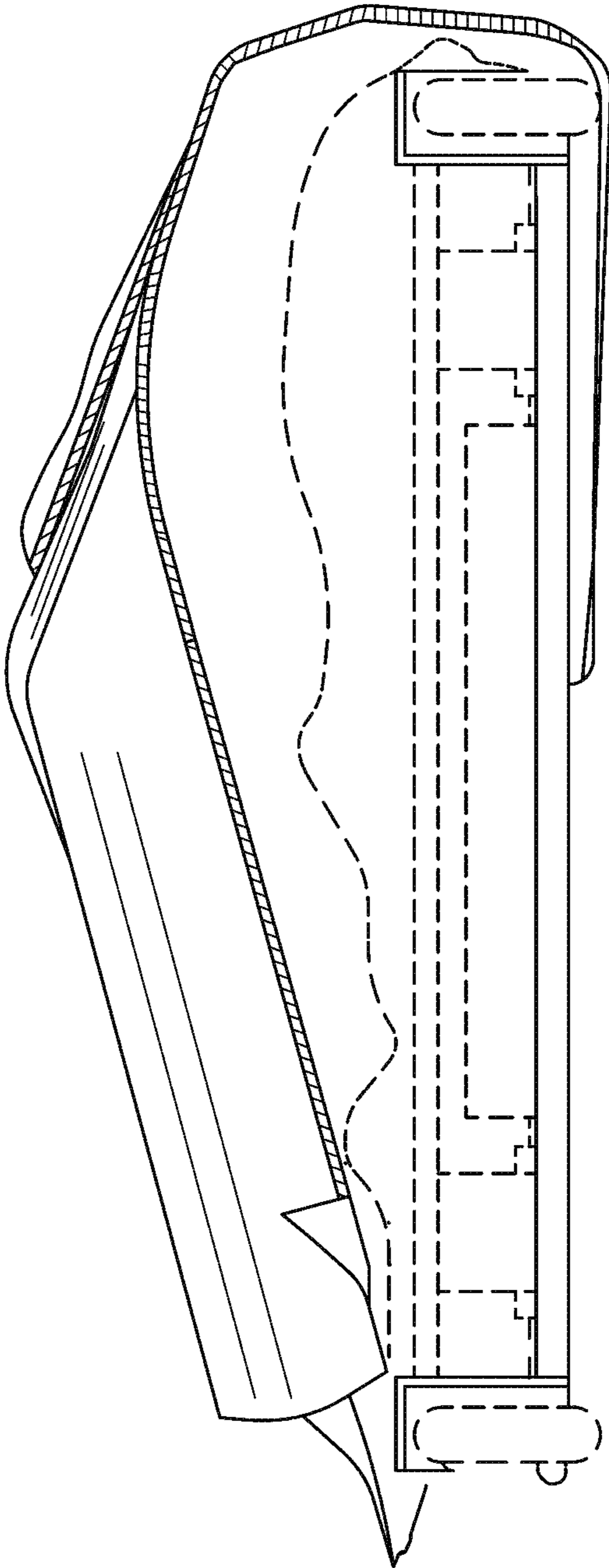

FIG. 5

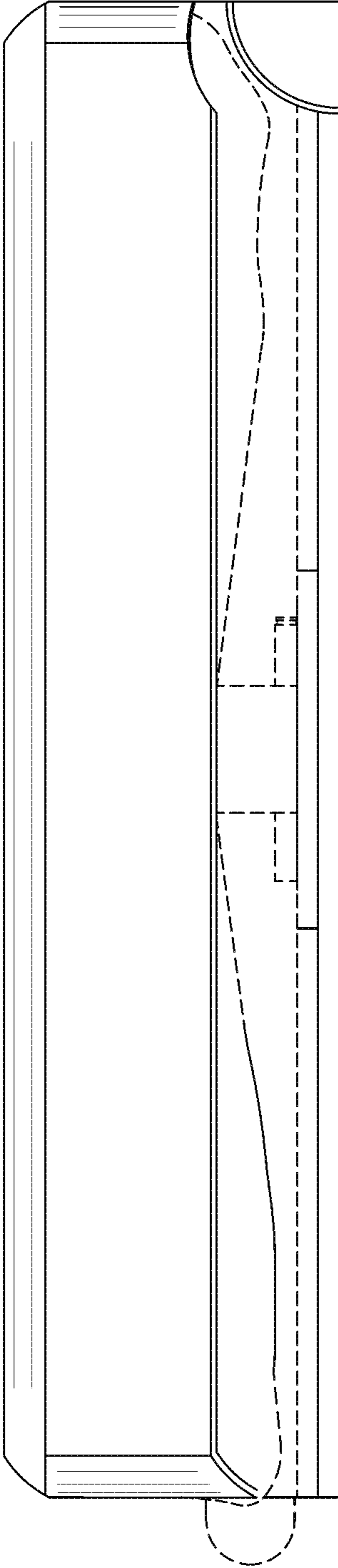

FIG. 6

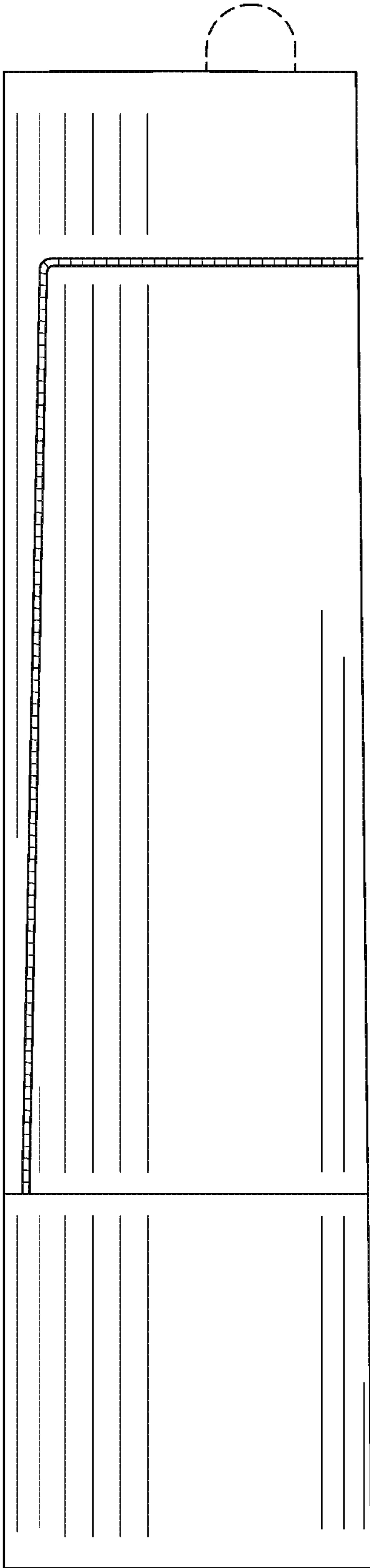

FIG. 7