



US00D777629S

(12) **United States Design Patent** (10) **Patent No.:** **US D777,629 S**
Lindsey (45) **Date of Patent:** **** *Jan. 31, 2017**

(54) **RIGHT FRONT FENDER FOR A CAR BODY**

D699,650 S * 2/2014 Peltola D12/184
D699,651 S * 2/2014 Peltola D12/184
D721,618 S * 1/2015 Hitzinger D12/91
D742,280 S * 11/2015 Schramm D12/88

(71) Applicant: **Robert Lindsey**, Braselton, GA (US)

(72) Inventor: **Robert Lindsey**, Braselton, GA (US)

(73) Assignee: **DELTA WING TECHNOLOGY GROUP, INC.**, Braselton, GA (US)

(*) Notice: This patent is subject to a terminal disclaimer.

(**) Term: **15 Years**

(21) Appl. No.: **29/538,601**

(22) Filed: **Sep. 4, 2015**

(51) **LOC (10) Cl.** **12-16**

(52) **U.S. Cl.**
USPC **D12/184**

(58) **Field of Classification Search**
USPC D12/86, 90-92, 184-186, 190, 196;
D21/424-425, 433-434
CPC B60R 13/04; B60R 19/54; B62D 25/12;
B62D 27/026; B62D 35/005; B60J 5/0412
See application file for complete search history.

(56) **References Cited**

U.S. PATENT DOCUMENTS

D218,340 S * 8/1970 McLaren D12/91
D221,378 S * 8/1971 Williams D12/92
D424,475 S * 5/2000 Cook D12/91
D424,981 S * 5/2000 Cook D12/91
D432,051 S * 10/2000 Lee D12/92
D438,144 S * 2/2001 Hettler D12/88
D526,598 S * 8/2006 Singer D12/88
D597,442 S * 8/2009 Steinhauser D12/88
D692,348 S * 10/2013 Whelan D12/92

OTHER PUBLICATIONS

<https://www.facebook.com/ElanMotorsports>—Earliest Publication Date Jul. 3, 2015.*
<https://www.youtube.com/watch?v=Bcr6Dxvg9EM>—Published Dec. 23, 2015.*
<http://www.trackhq.com/forums/f303/nasa-elan-np01-thread-8744/>—Published Sep. 9, 2015.*
<https://www.motul.com/mx/en/news/events-racing/european-le-mans-series-france-le-castellet>—Published Mar. 19, 2012.*

* cited by examiner

Primary Examiner — Manpreet Matharu

Assistant Examiner — Mojtaba Tehrani

(74) *Attorney, Agent, or Firm* — Withers & Keys, LLC

(57) **CLAIM**

The ornamental design for a right front fender for a car body, as shown and described.

DESCRIPTION

FIG. 1 is a front-left perspective view of the right front fender for a car body, showing my new design; FIG. 2 is a front-right perspective view thereof; FIG. 3 is a left side view thereof; FIG. 4 is a right side view thereof; FIG. 5 is a top view thereof; FIG. 6 is a bottom view thereof; FIG. 7 is a front view thereof; and, FIG. 8 is a rear view thereof.

The broken lines shown in the drawings illustrate portions of the right front fender for a car body that forms no part of the claimed design.

1 Claim, 8 Drawing Sheets

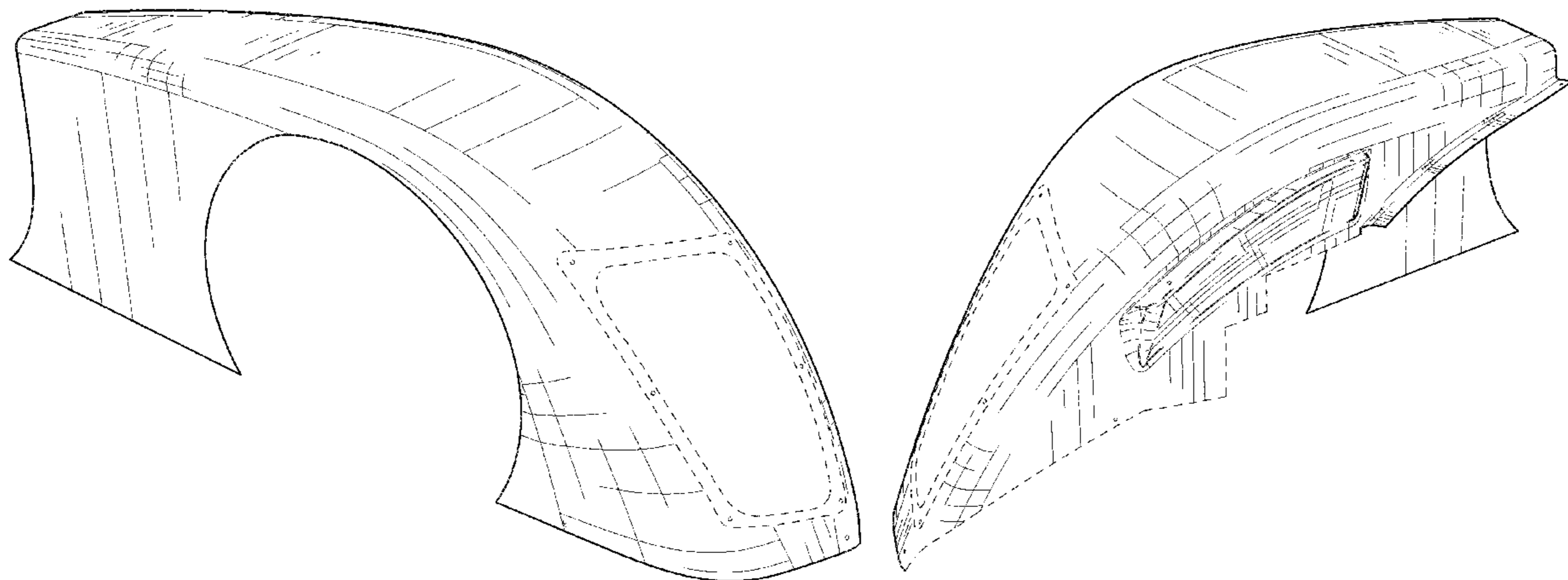

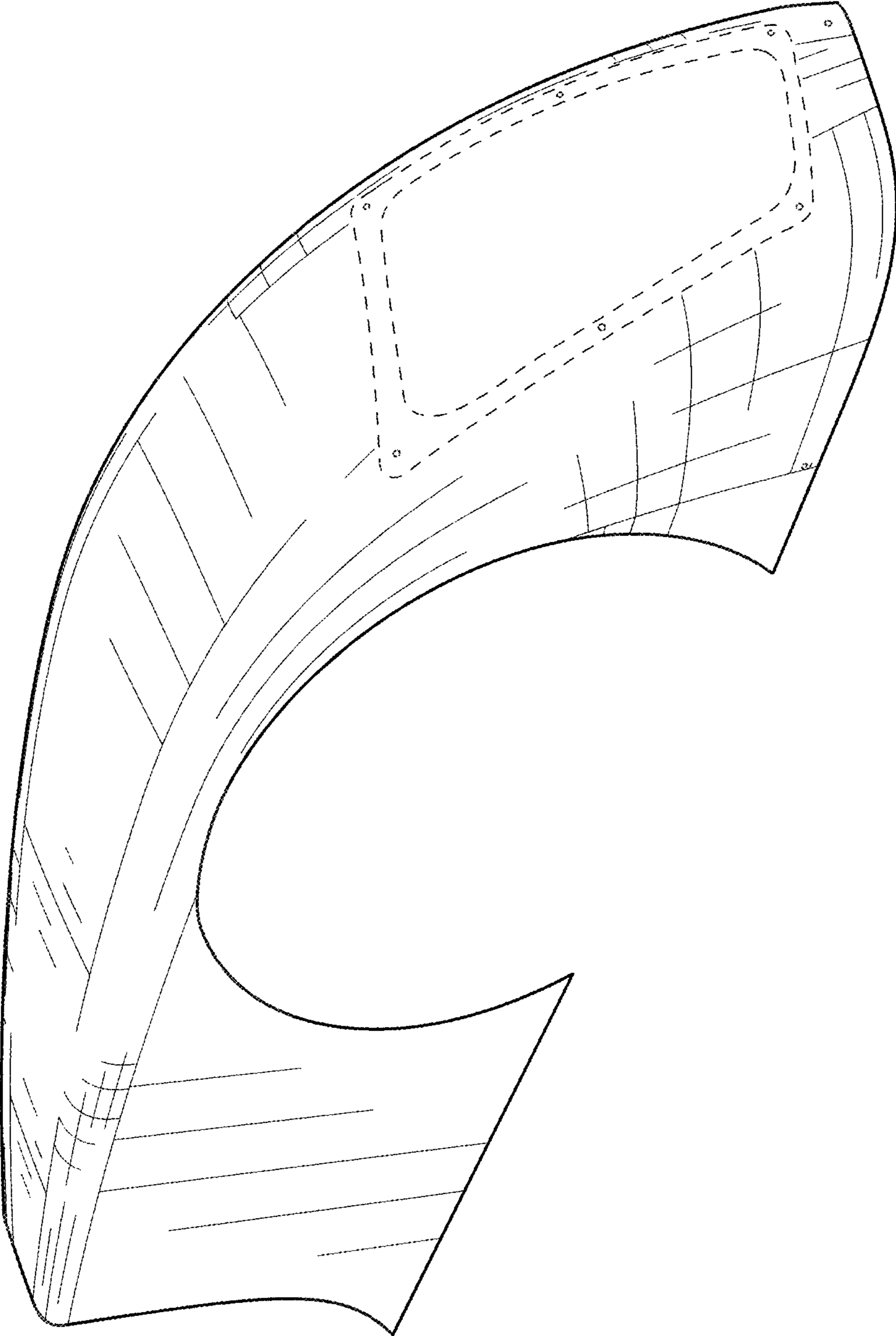

FIG. 1

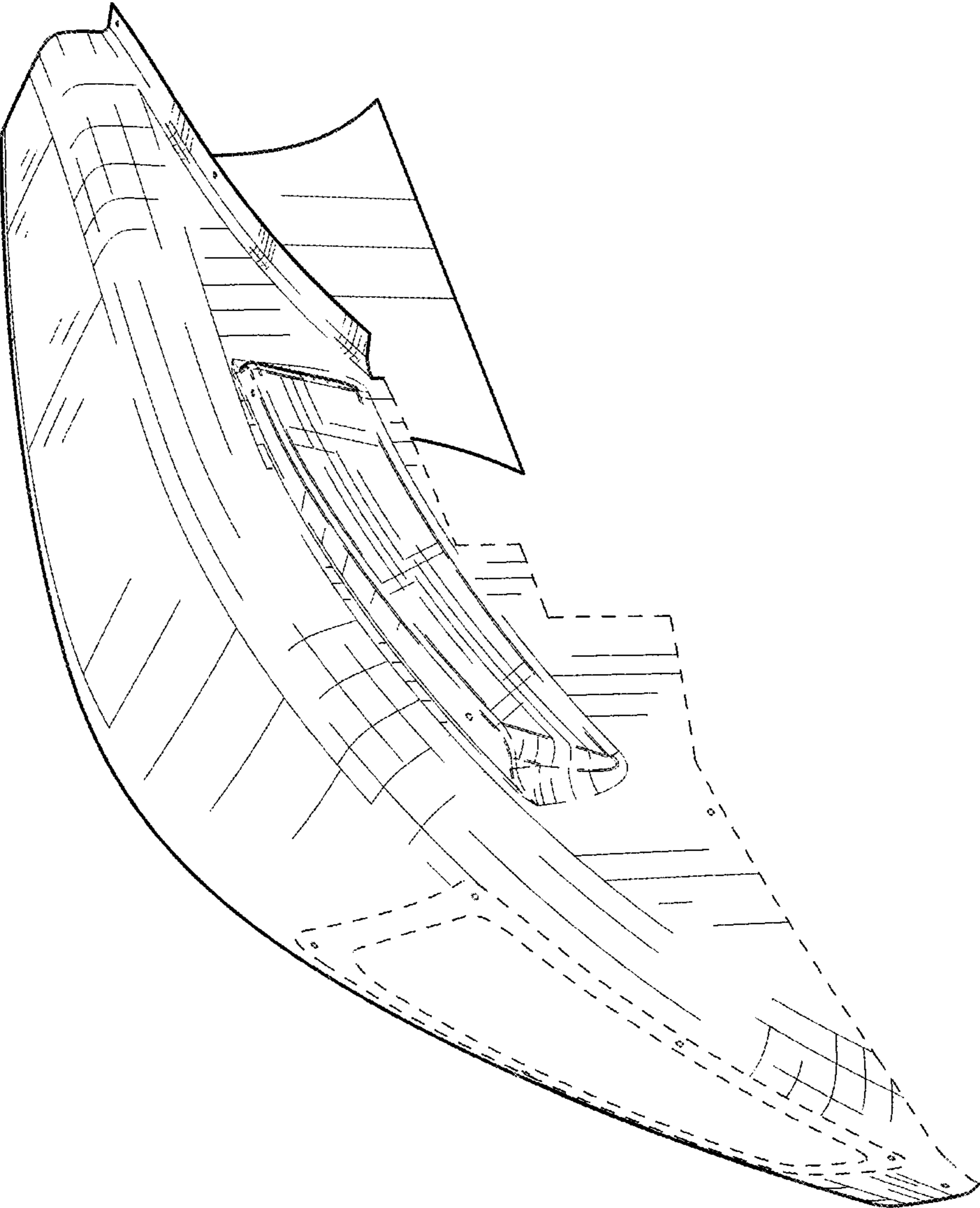

FIG. 2

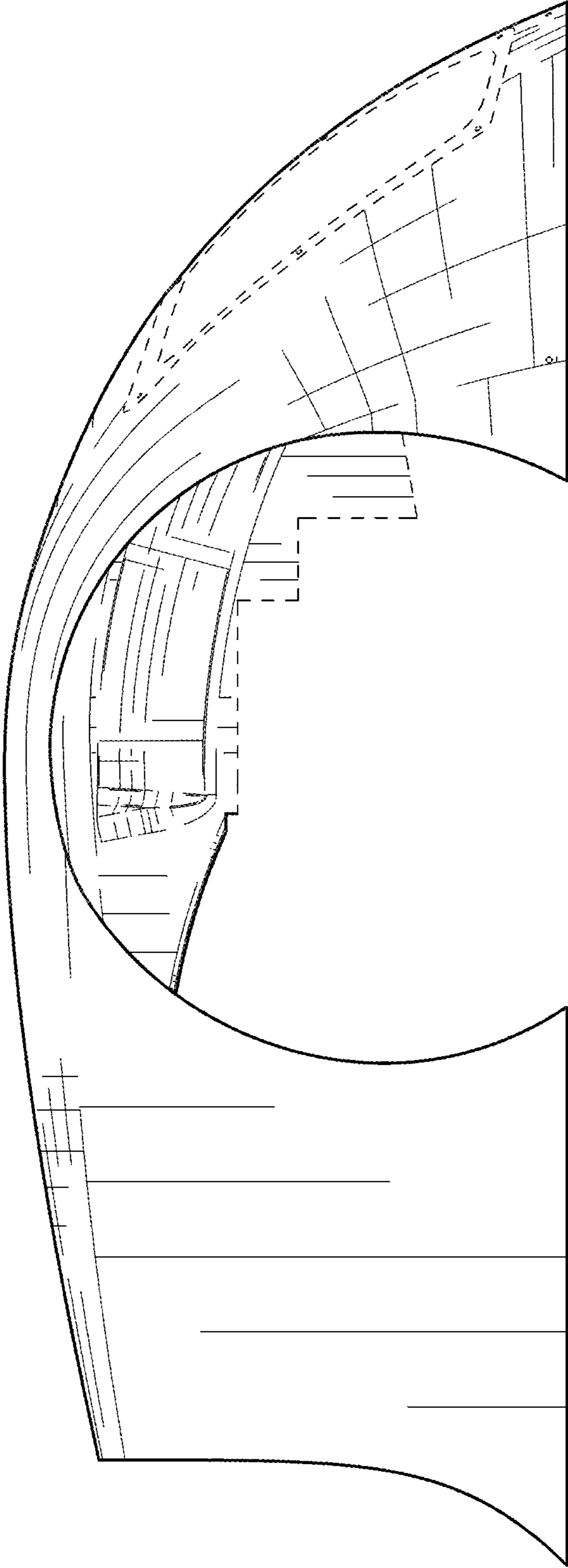

FIG. 3

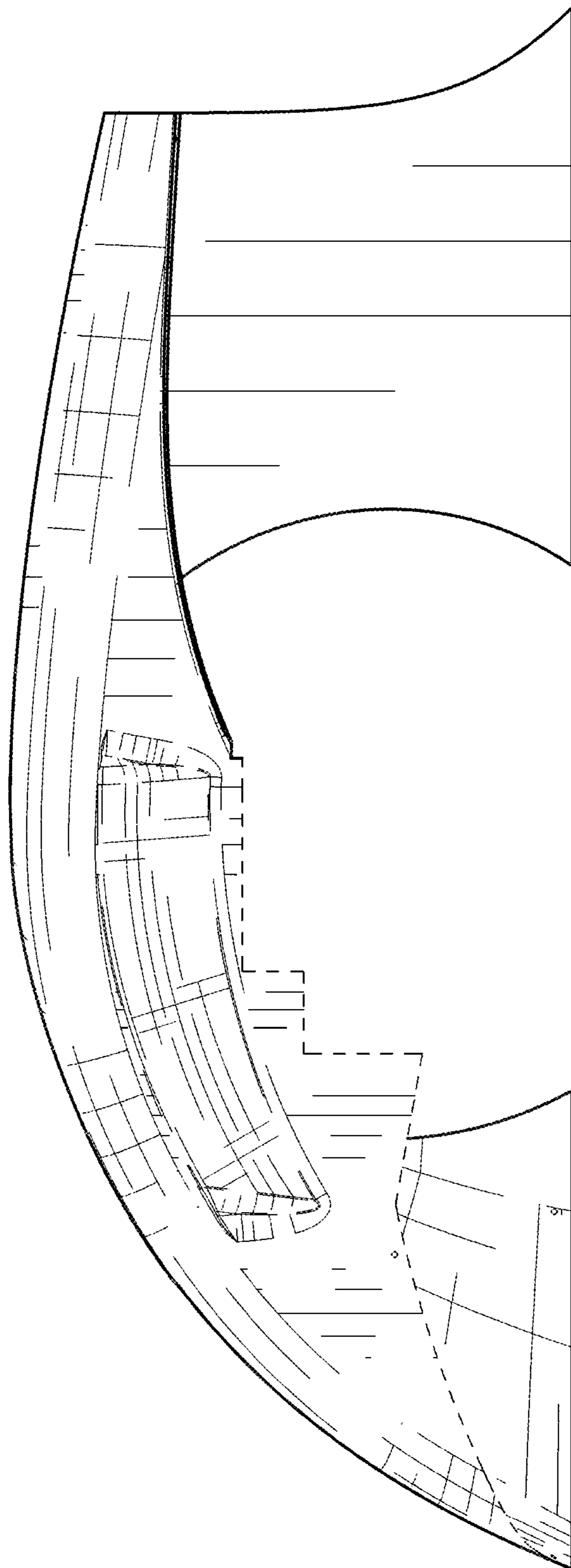

FIG. 4

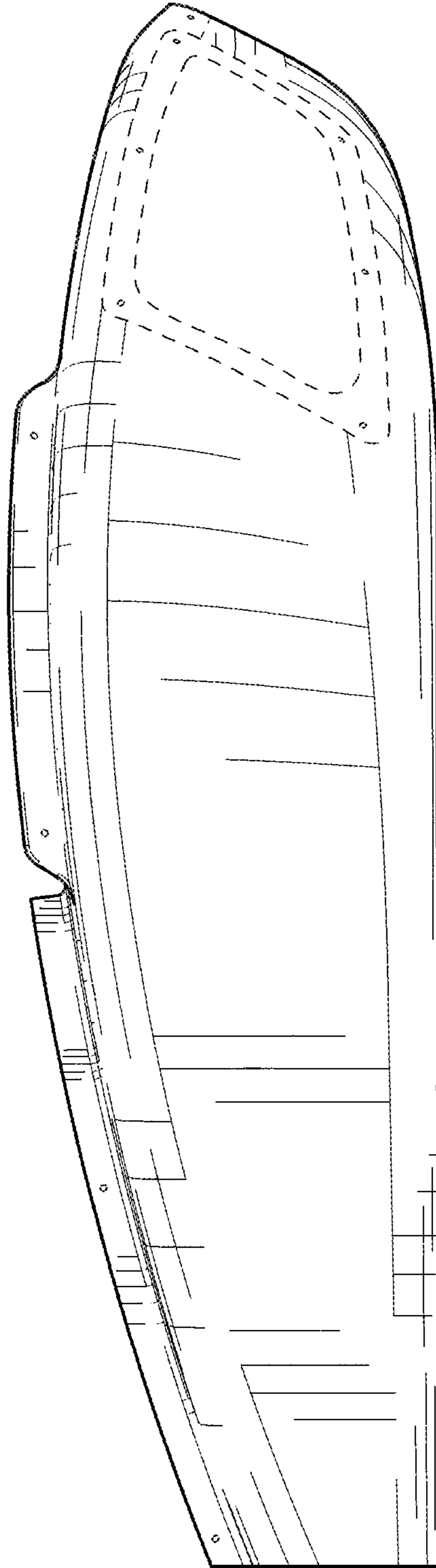

FIG. 5

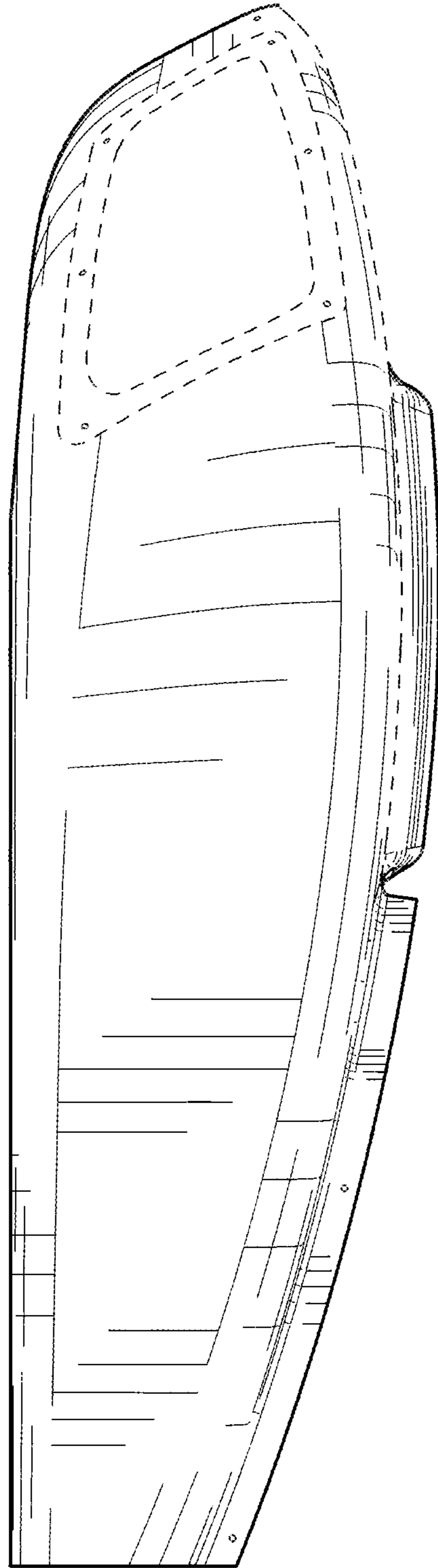

FIG. 6

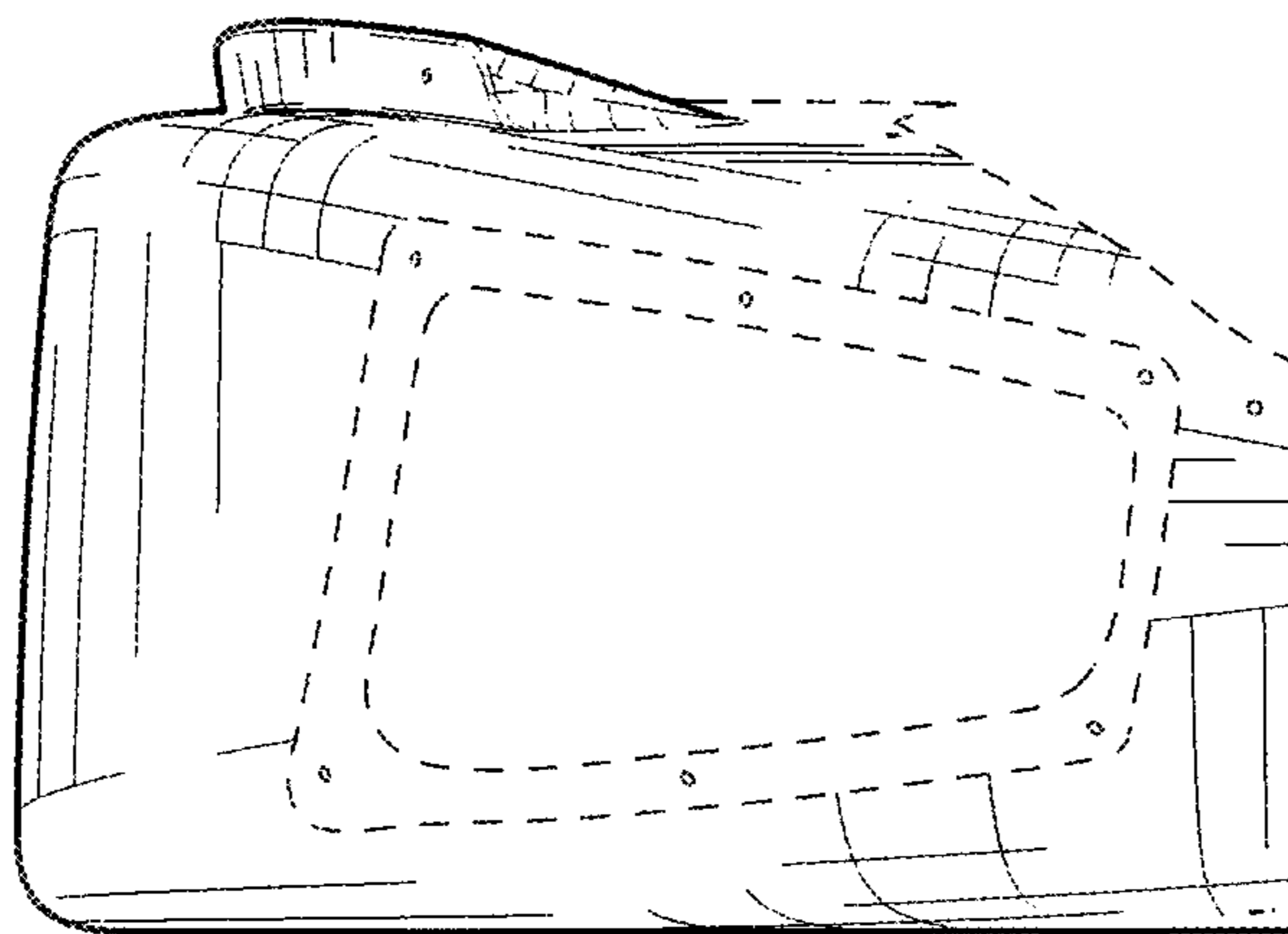

FIG. 7

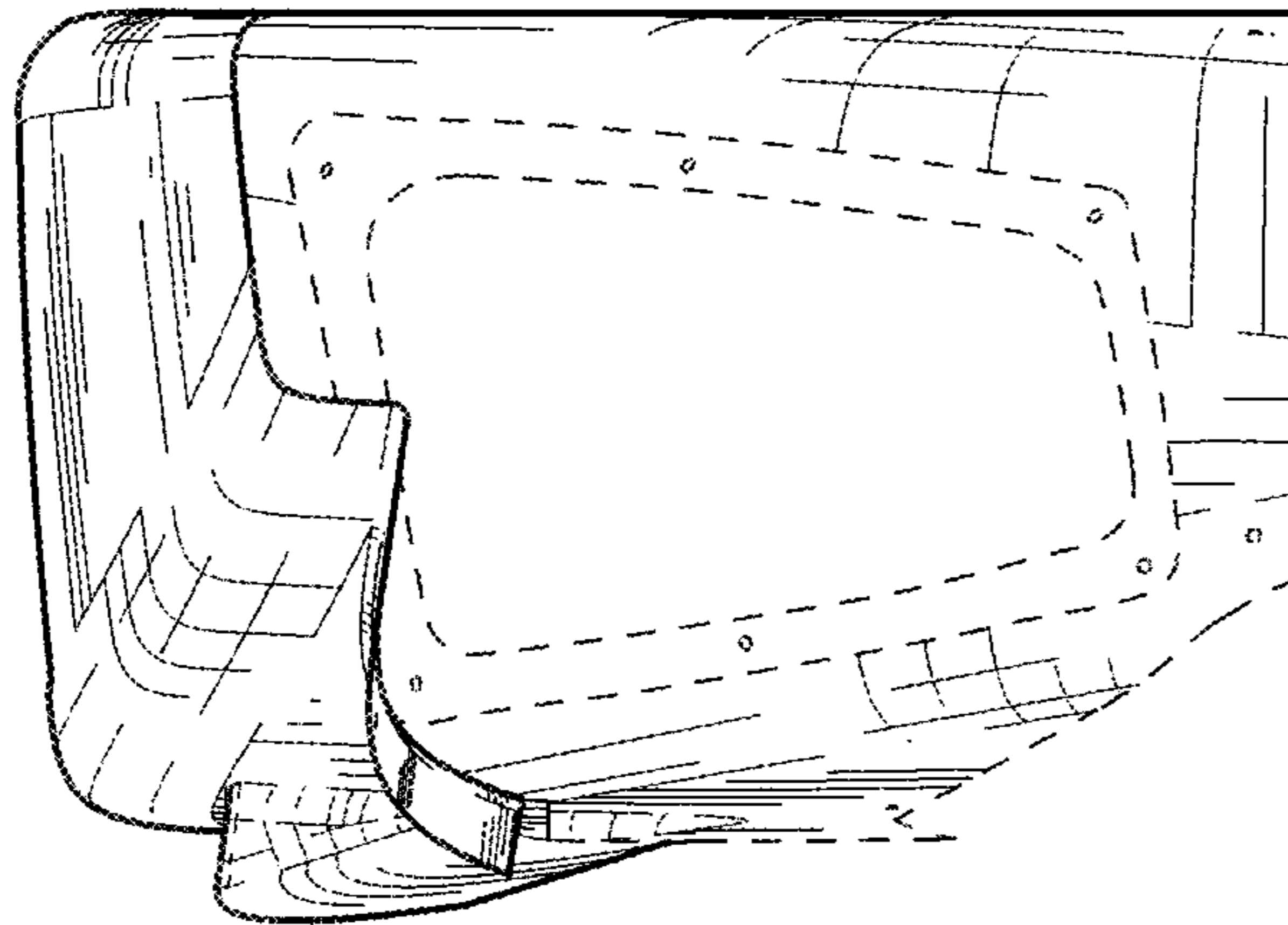

FIG. 8