



US00D777596S

(12) **United States Design Patent**
Calvani

(10) **Patent No.:** **US D777,596 S**

(45) **Date of Patent:** **** Jan. 31, 2017**

(54) **WATCH DIAL**

(71) Applicant: **ROLEX WATCH U.S.A., INC.**, New York, NY (US)

(72) Inventor: **Maria Cristina Calvani**, Cologny (CH)

(73) Assignee: **ROLEX WATCH U.S.A., Inc.**, New York, NY (US)

(**) Term: **15 Years**

(21) Appl. No.: **29/537,431**

(22) Filed: **Aug. 26, 2015**

(30) **Foreign Application Priority Data**

Feb. 26, 2015 (CH) 141310

(51) **LOC (10) Cl.** **10-07**

(52) **U.S. Cl.**
USPC **D10/126**

(58) **Field of Classification Search**
USPC D10/1-39, 122-130, 45; D11/44;
368/20-21, 28, 223
CPC G04B 19/06; G04B 19/10; G04B 19/08;
G04B 19/103; G04B 19/106; G04B
47/042; G04B 45/0076; G04G 9/087
See application file for complete search history.

(56) **References Cited**

U.S. PATENT DOCUMENTS

D356,742 S *	3/1995	Chenwu	D10/126
D454,310 S *	3/2002	Dostourian	D10/30
D523,358 S *	6/2006	Lillegard	D10/39
D555,521 S *	11/2007	Gruosi-Scheufele	D10/39
D568,197 S *	5/2008	Wartersian	D10/126
D688,580 S *	8/2013	Delhotal	D10/124
D701,134 S *	3/2014	Cerrato	D10/126
D710,730 S *	8/2014	Delhotal	D10/124
D710,731 S *	8/2014	Calvani	D10/126

D718,648 S *	12/2014	Calvani	D10/126
D720,638 S *	1/2015	Rogers	D10/125
D722,901 S *	2/2015	Cerrato	D10/126
D723,963 S *	3/2015	Gueit	D10/126
D728,403 S *	5/2015	Calvani	D10/126
D743,829 S *	11/2015	Meylan	D10/126
D746,713 S *	1/2016	Cerrato	D10/126
D747,994 S *	1/2016	Stegmann	D10/125
D753,007 S *	4/2016	Muller	D10/126
2011/0032802 A1 *	2/2011	Muller	G04B 19/23 368/22
2012/0243379 A1 *	9/2012	Balli	G04G 21/00 368/10
2013/0064045 A1 *	3/2013	Essery	H04W 88/02 368/47
2014/0064039 A1 *	3/2014	Jones	G04G 9/087 368/14

* cited by examiner

Primary Examiner — Rosemary K Tarcza

Assistant Examiner — James Thorn, Jr.

(74) *Attorney, Agent, or Firm* — Sughrue Mion, PLLC

(57) **CLAIM**

The ornamental design for a watch dial, as shown and described.

DESCRIPTION

FIG. 1 is a perspective view of the watch dial according to my new design;

FIG. 2 is a front view thereof;

FIG. 3 is a rear view thereof;

FIG. 4 is a left side view thereof;

FIG. 5 is a right side view thereof;

FIG. 6 is a top view thereof; and,

FIG. 7 is a bottom view thereof.

The broken lines shown in the drawings are included for the purpose of illustrating environmental structure and form no part of the claimed design.

1 Claim, 5 Drawing Sheets

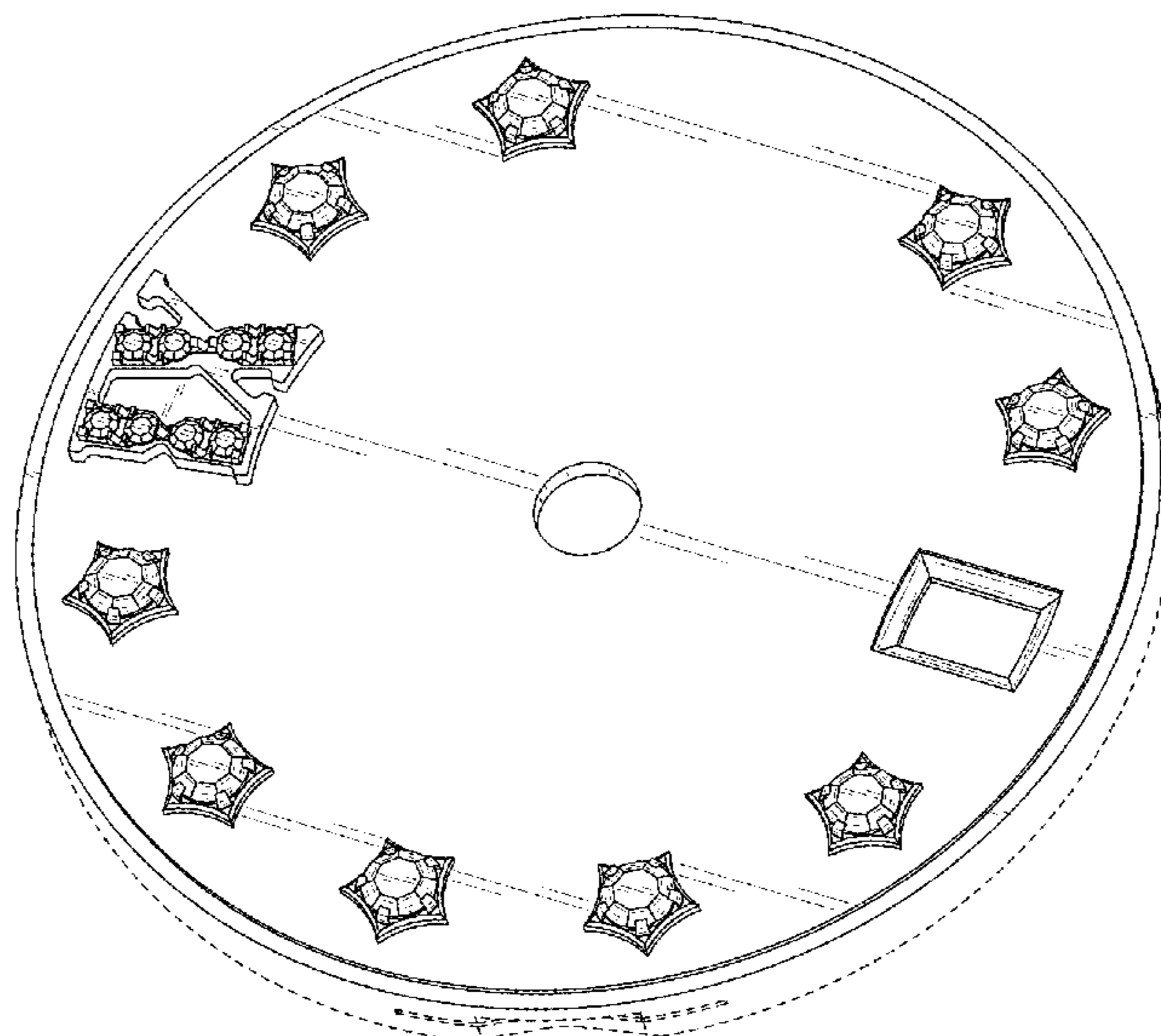

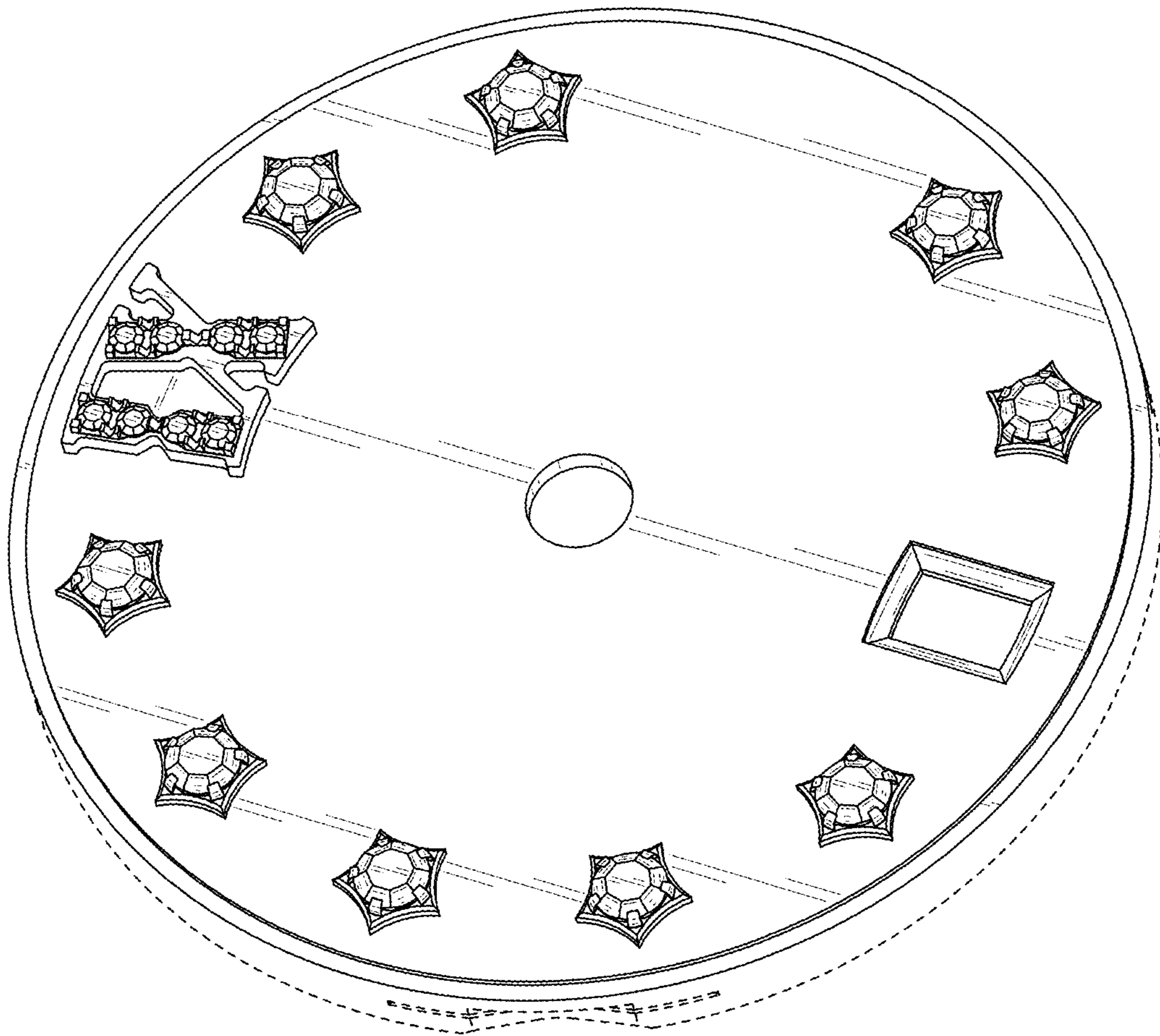

FIG. 1

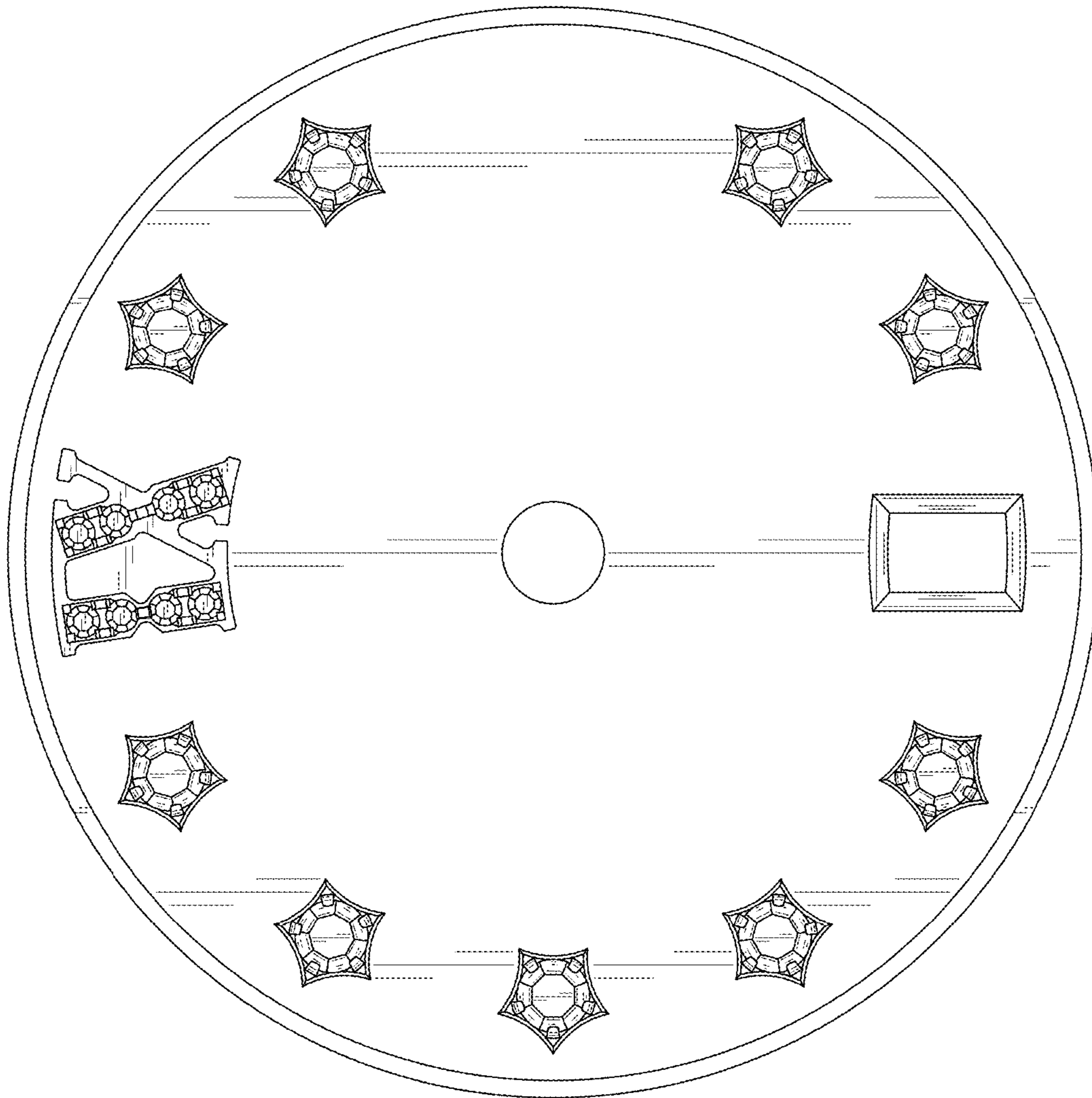

FIG. 2

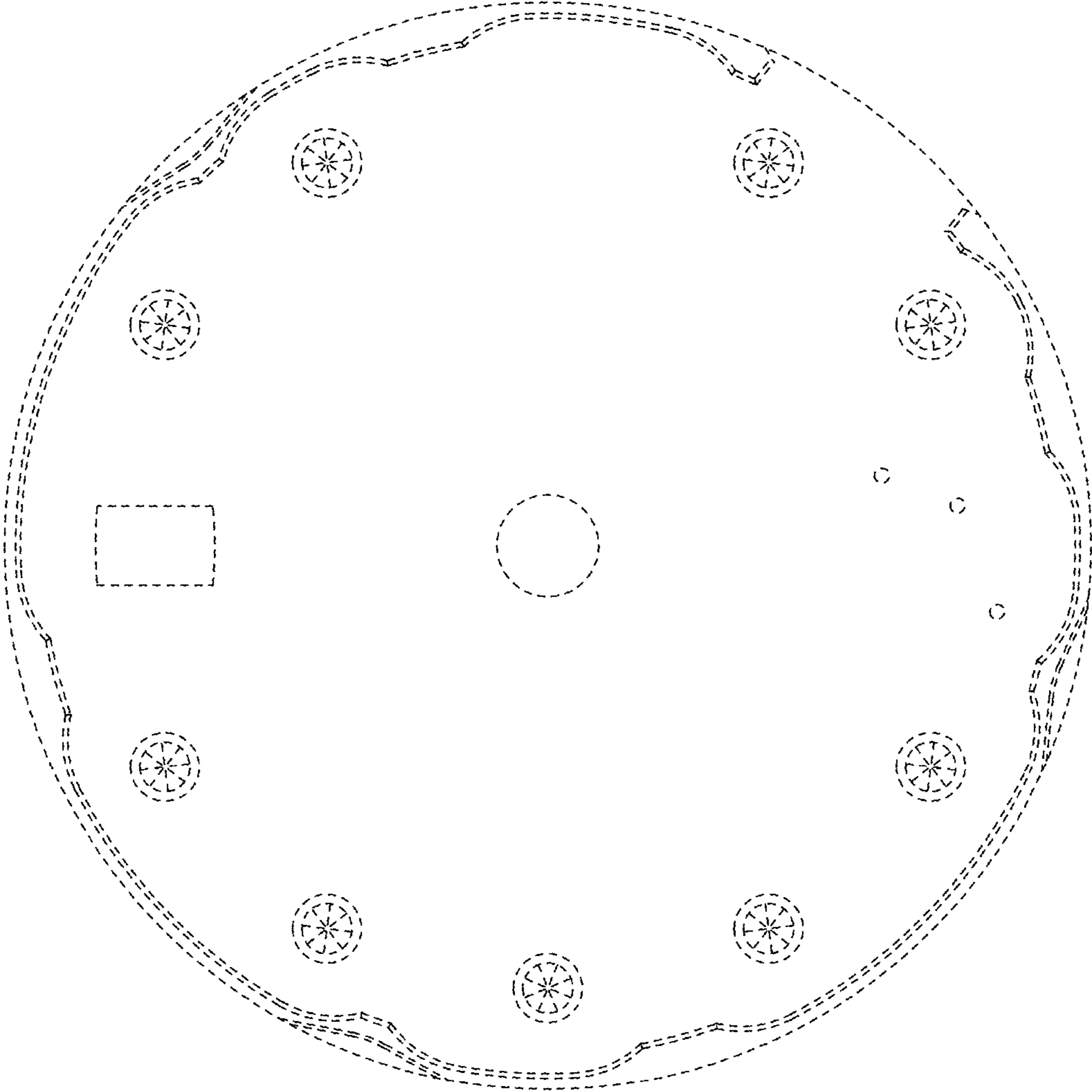

FIG. 3

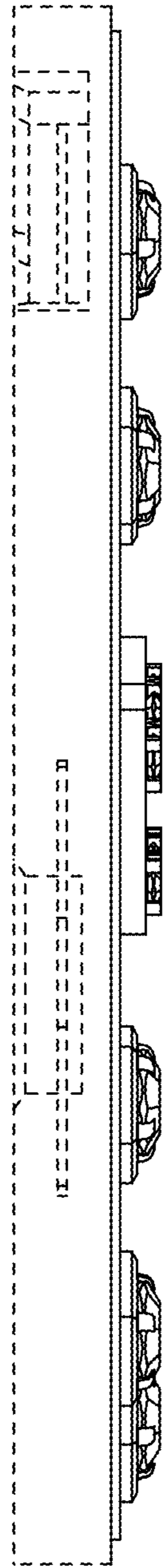

FIG. 4

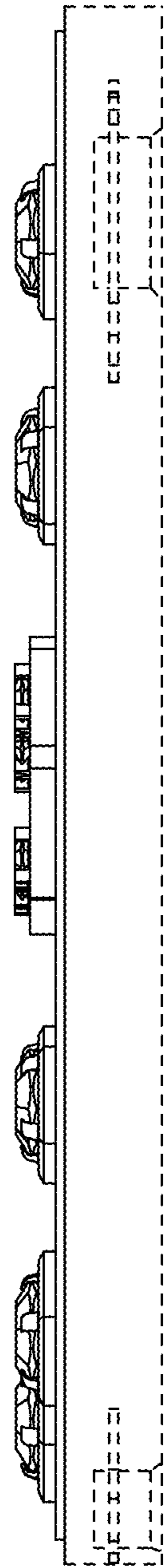

FIG. 5

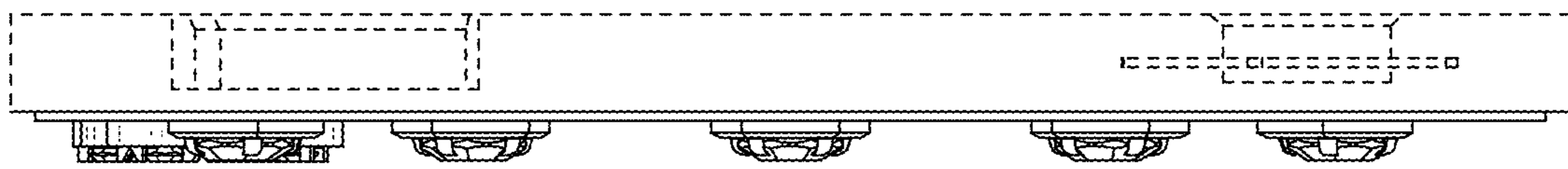

FIG. 6

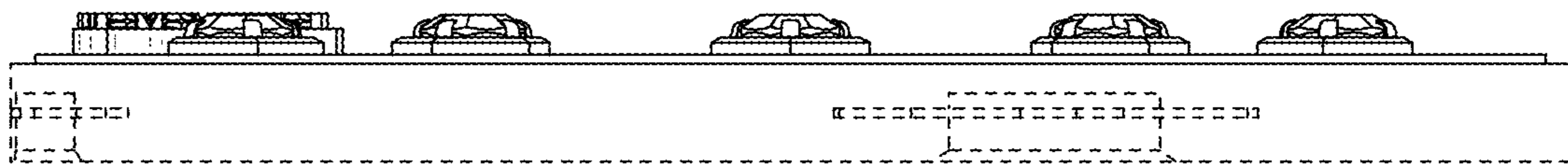

FIG. 7