



US00D777568S

(12) **United States Design Patent** (10) **Patent No.:** **US D777,568 S**
Forbes et al. (45) **Date of Patent:** **** Jan. 31, 2017**

(54) **ORNAMENT ATTACHMENT CLIP**

- (71) Applicant: **TARGET BRANDS, INC.**,
Minneapolis, MN (US)
- (72) Inventors: **Kathryn D. Forbes**, Minnetonka, MN
(US); **Monica R. Rush**, Minneapolis,
MN (US)
- (73) Assignee: **Target Brands, Inc.**, Minneapolis, MN
(US)
- (**) Term: **15 Years**
- (21) Appl. No.: **29/529,757**
- (22) Filed: **Jun. 10, 2015**

Related U.S. Application Data

- (63) Continuation of application No. 29/460,102, filed on
Jul. 8, 2013, now Pat. No. Des. 736,075.
- (51) **LOC (10) Cl.** **08-08**
- (52) **U.S. Cl.**
USPC **D8/396; D8/394**
- (58) **Field of Classification Search**
USPC D8/394, 396
(Continued)

(56) **References Cited**

U.S. PATENT DOCUMENTS

- 2,053,139 A 9/1936 Donovan et al.
 - 2,063,924 A 12/1936 Hanko
- (Continued)

FOREIGN PATENT DOCUMENTS

DE 3239082 A1 4/1984

OTHER PUBLICATIONS

“Candle Clip-On Ornaments,” printed from <http://store.gianis.com/gm501r.html> available at least as early as Sep. 14, 2011 (1 page).
(Continued)

Primary Examiner — Holly Baynham
(74) *Attorney, Agent, or Firm* — JoAnn M. Seaton;
Griffiths & Seaton PLLC

(57) **CLAIM**
The ornamental design for an ornament attachment clip, as shown and described.

DESCRIPTION

FIG. 1 is a front, perspective view of an ornament attachment clip showing our new design in a closed position; FIG. 2 is a front view thereof; FIG. 3 is a rear view thereof; FIG. 4 is a right side view thereof; FIG. 5 is a left side view thereof; FIG. 6 is a top view thereof; and FIG. 7 is a bottom view thereof. FIG. 8 is a front, perspective view of the ornament attachment clip of FIG. 1 with additional environmental subject matter illustrated in broken lines. FIG. 9 is a front, perspective view of the ornament attachment clip of FIG. 1 in an open position; FIG. 10 is a front view thereof; FIG. 11 is a rear view thereof; FIG. 12 is a right side view thereof; FIG. 13 is a left side view thereof; FIG. 14 is a top view thereof; and, FIG. 15 is a bottom view thereof. The features shown in broken lines are portions of the ornament attachment clip or environmental subject matter to the ornament attachment clip forming no part of the claimed design. The features shown in long dash-short dash bolded broken lines indicate the bounds of the claimed design and otherwise form no part of the claimed design.

1 Claim, 15 Drawing Sheets

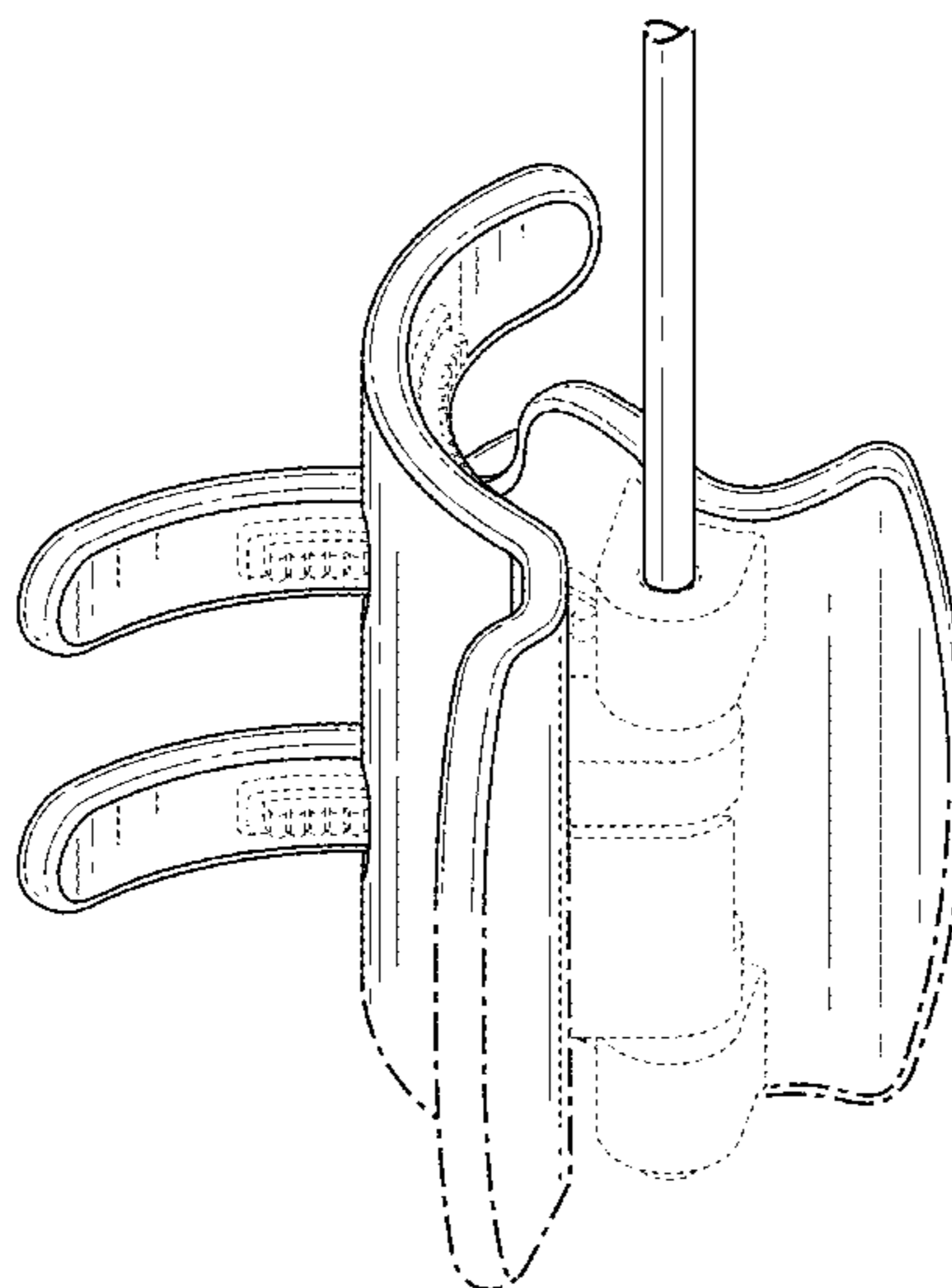

(58) **Field of Classification Search**
 CPC A45D 8/20; A45D 8/24; A45D 8/30
 See application file for complete search history.

2007/0031635 A1 2/2007 Shepardson
 2010/0096526 A1 4/2010 Richardson
 2011/0114807 A1 5/2011 Richardson

(56) **References Cited**

U.S. PATENT DOCUMENTS

2,521,394	A	9/1950	Minners	
2,599,303	A	3/1952	Ward	
3,386,070	A	5/1968	Jansson et al.	
5,549,268	A	8/1996	Hopwood	
5,975,092	A	11/1999	Tsai	
5,988,184	A	11/1999	Shu	
7,175,145	B2	2/2007	Simpson	
7,299,808	B2 *	11/2007	Lau	A45D 8/20 132/277
7,419,277	B2	9/2008	Von Ronn et al.	
7,419,283	B2	9/2008	Von Ronn et al.	
7,493,903	B2	2/2009	Rogers et al.	
7,717,388	B2	5/2010	Rizzo	
7,992,579	B2	8/2011	Longoria et al.	
8,109,279	B2	2/2012	Chudzik et al.	
8,186,364	B2	5/2012	Silva	
8,276,598	B1	10/2012	Shepard et al.	
8,863,761	B2	10/2014	Wang	
9,049,914	B2 *	6/2015	Sze	A45D 8/26
D736,075	S *	8/2015	Forbes	D8/396
9,232,841	B1 *	1/2016	Hsu	A45D 8/20
9,445,656	B2 *	9/2016	Hsu	A45D 8/20
2007/0029222	A1	2/2007	Shepardson	

OTHER PUBLICATIONS

Photograph of Hair Clip, (1 page).
 "What is it with Boys Being Obsessed with Hair Clips?," printed from <http://sheenaspace.wordpress.com/2012/05/01/what-is-it-with-boys-being-obsessed-with-hair-clips/> published May 1, 2012 (2 pages).
 "Club Medium Claw Clips," printed from www.goody.com/Products/Hair_Accessories/Classics_Medium_Claw.Clips, (1 page).
 "Holiday Hair," printed from www.styleblueprint.com/health-and-beauty/holiday-hair/ posted on Dec. 8, 2011 (7 pages).
 Office Action from Canadian Patent Application No. 153,489, mailed Aug. 14, 2014 (2 pages).
 Office Action from Canadian Patent Application No. 2,855,846, mailed Sep. 22, 2014 (4 pages).
 GKI Bethlehem Lighting Reflections Novelty Christmas Tree Topper with Morphing LED and Mounting Arm, Bethlehem Star. GKI Bethlehem Lighting. Amazon.com, May 3, 2011 (oldest review date Jan. 7, 2009) [retrieved on Sep. 16, 2014]. Retrieved from the internet: <<http://www.amazon.com/GKI-Bethlehem-Lighting-Reflections-Christmas/dp/B0014XUTMG>> (6 pages).
 "Club Pack of 24 Red and Gold Glass Candle Clip-On Christmas Ornaments 5.5," printed from <http://shop.christmascentral.com/items/item.aspx?itemid=10836187> available at least as early as Sep. 14, 2011 (2 pages).

* cited by examiner

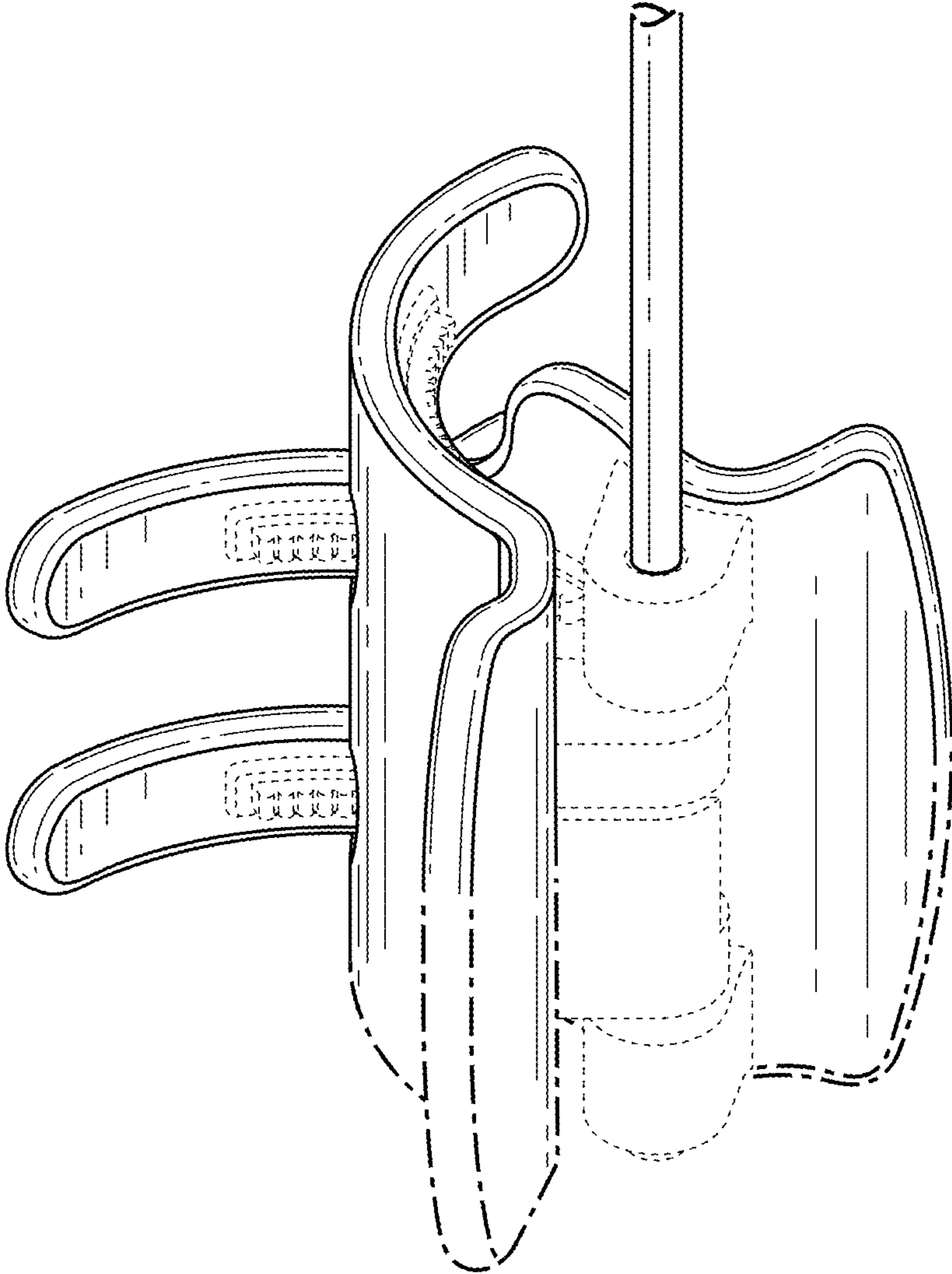

FIG. 1

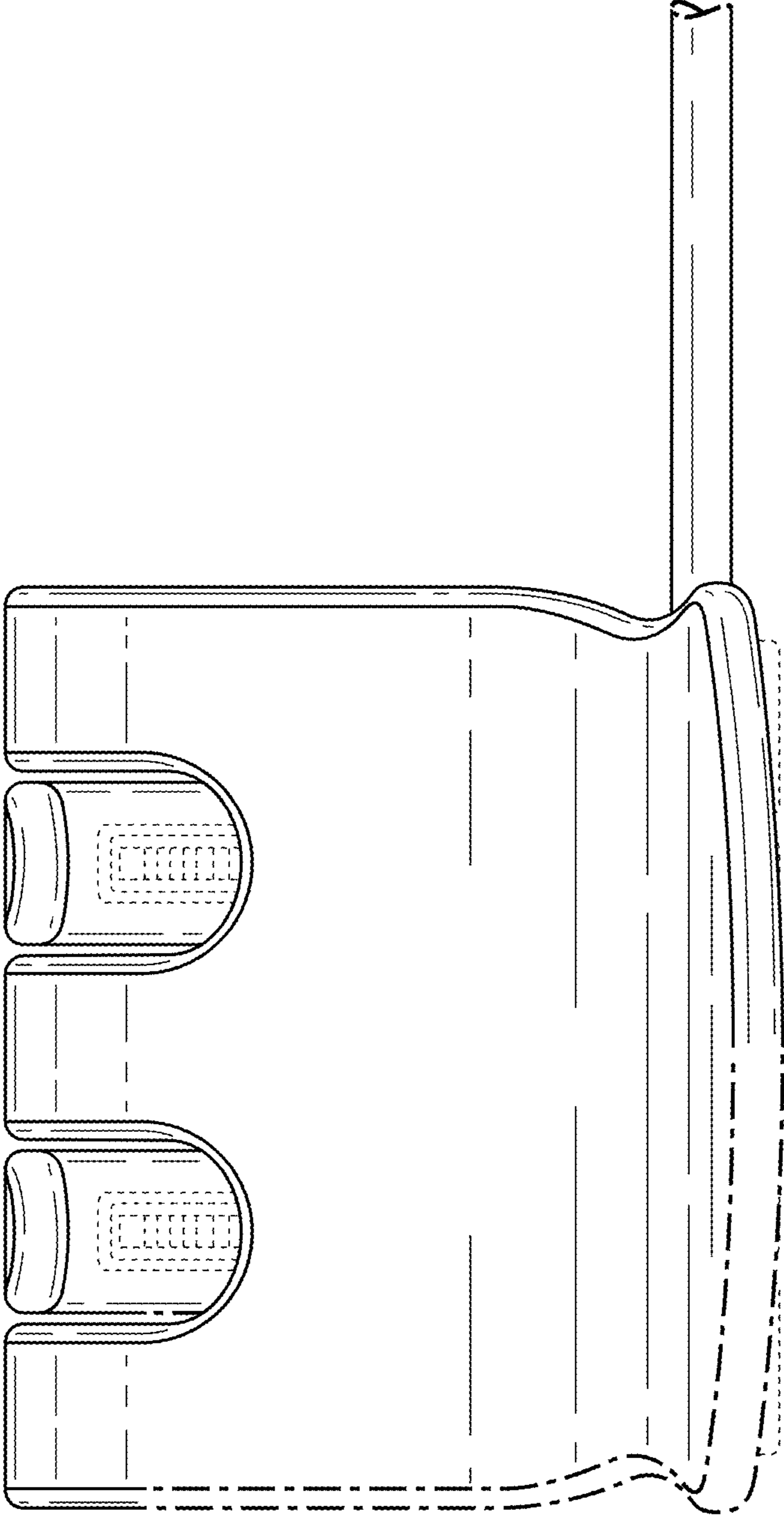

FIG. 2

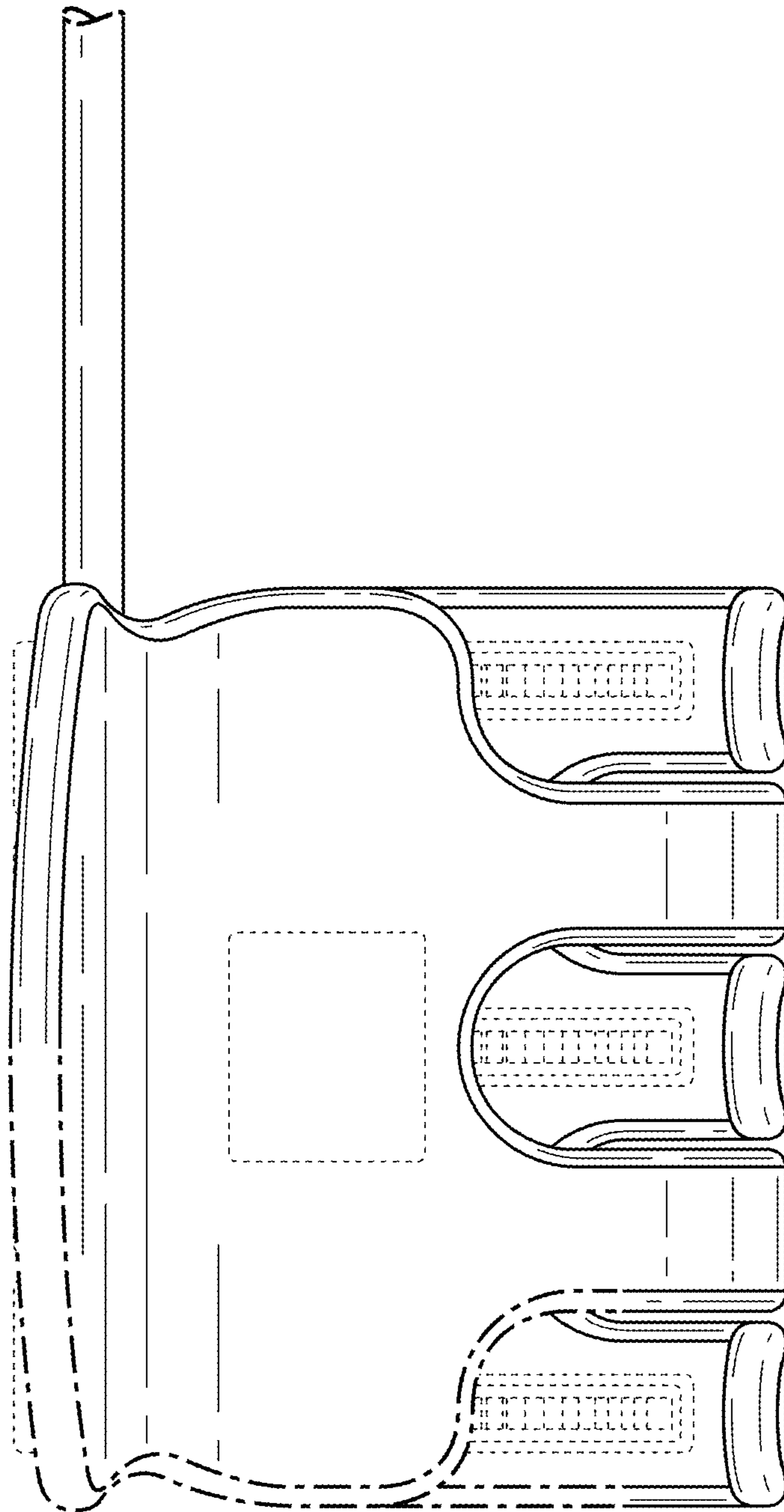

FIG. 3

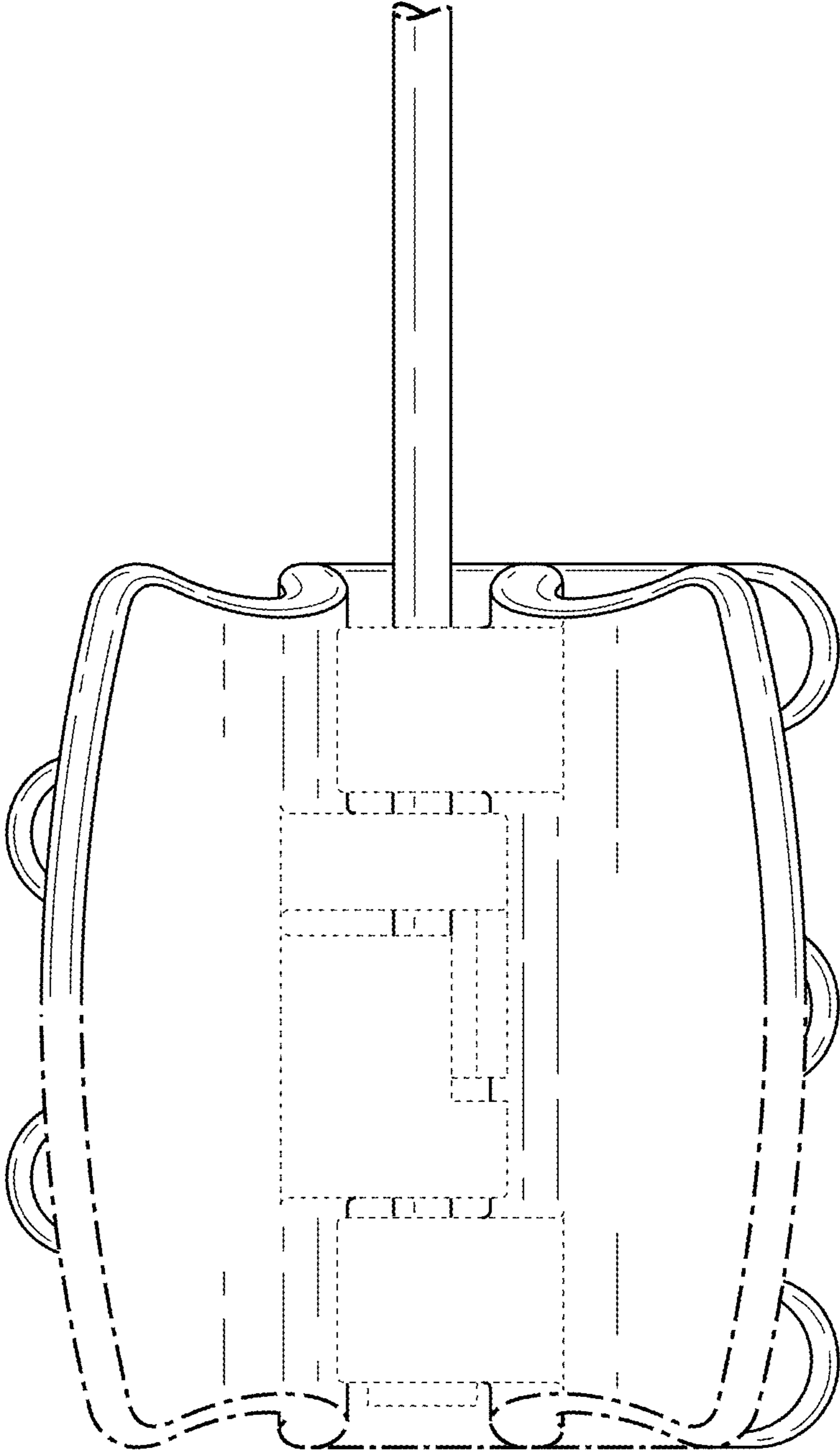

FIG. 4

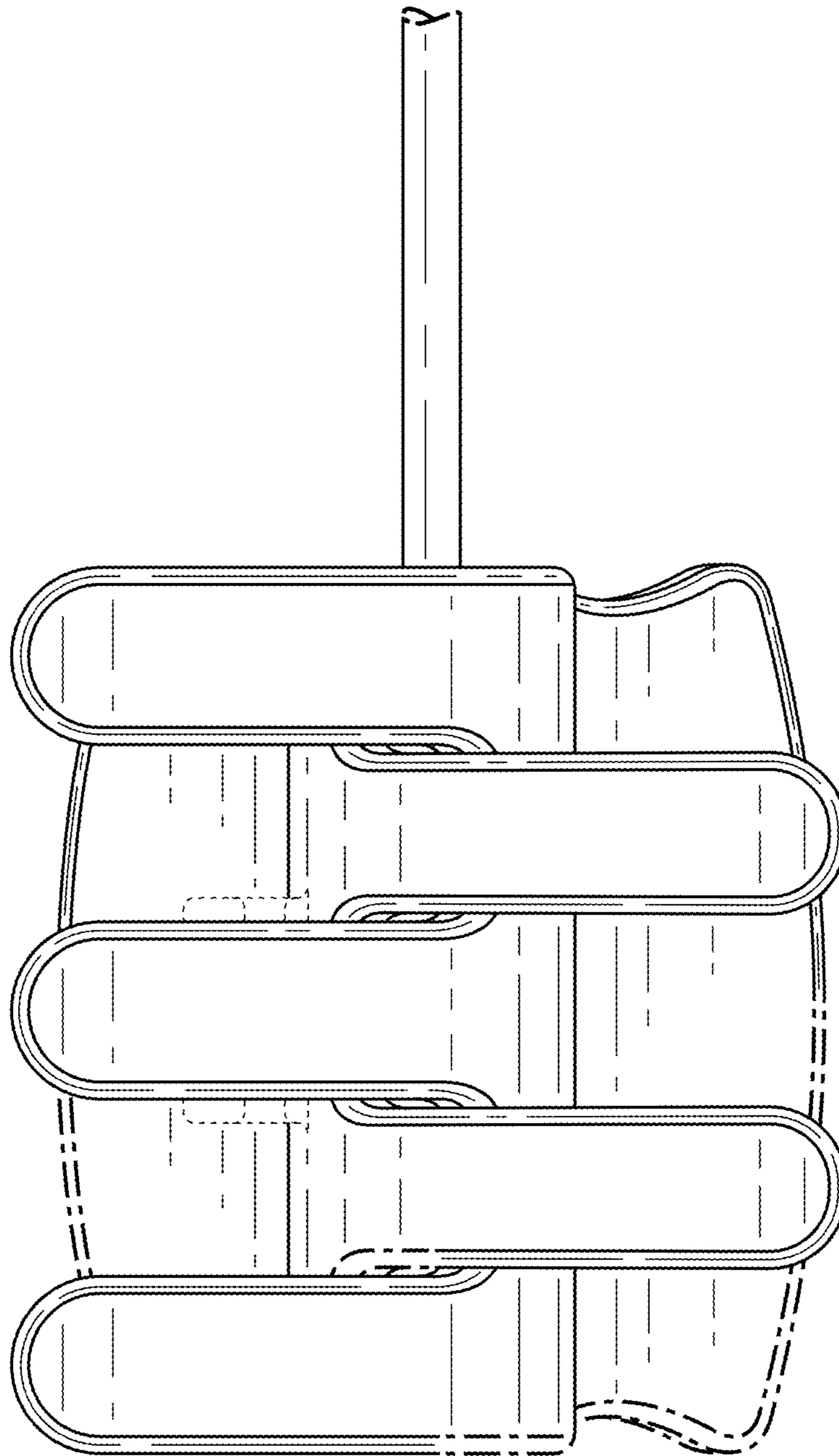

FIG. 5

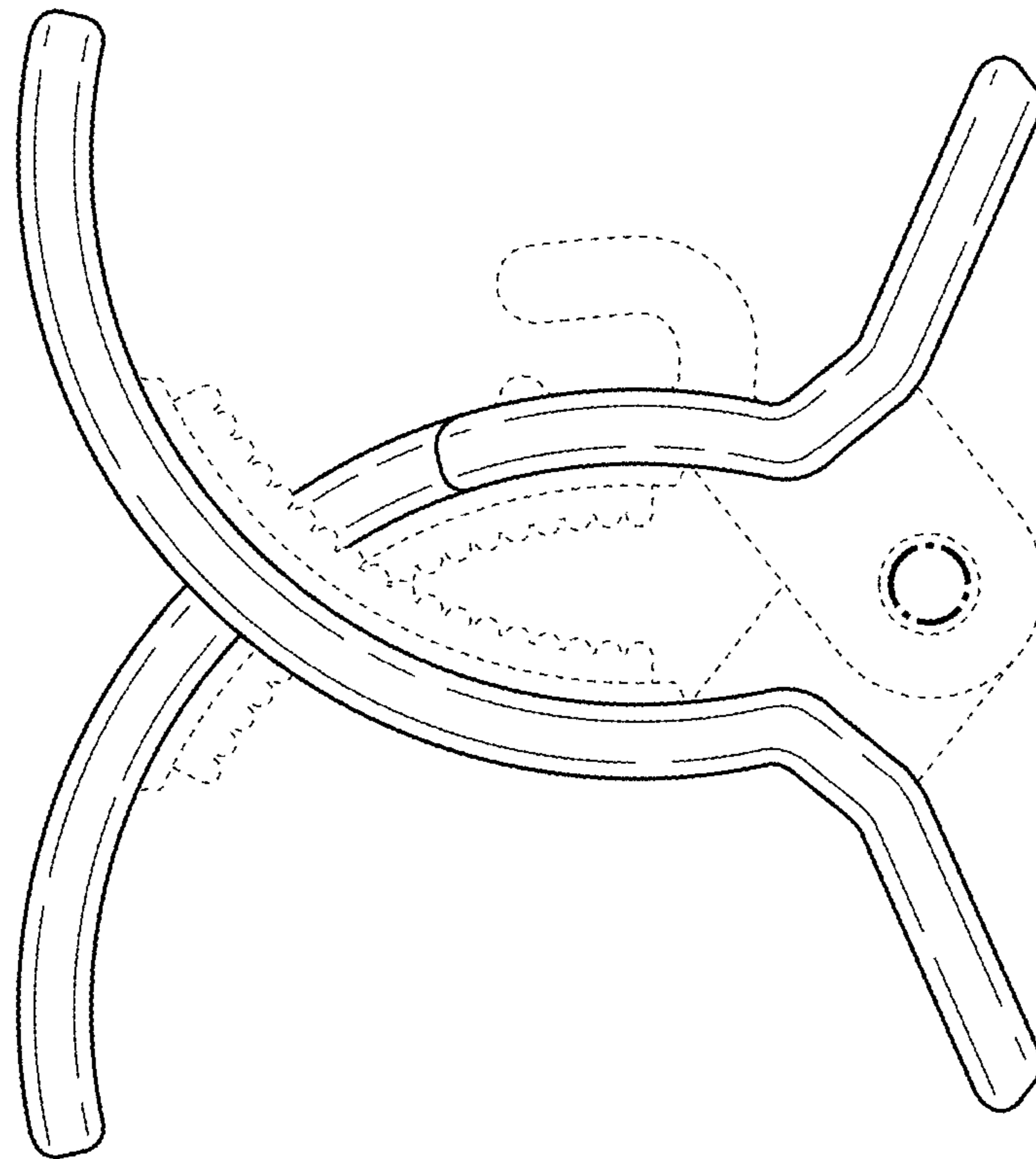

FIG. 6

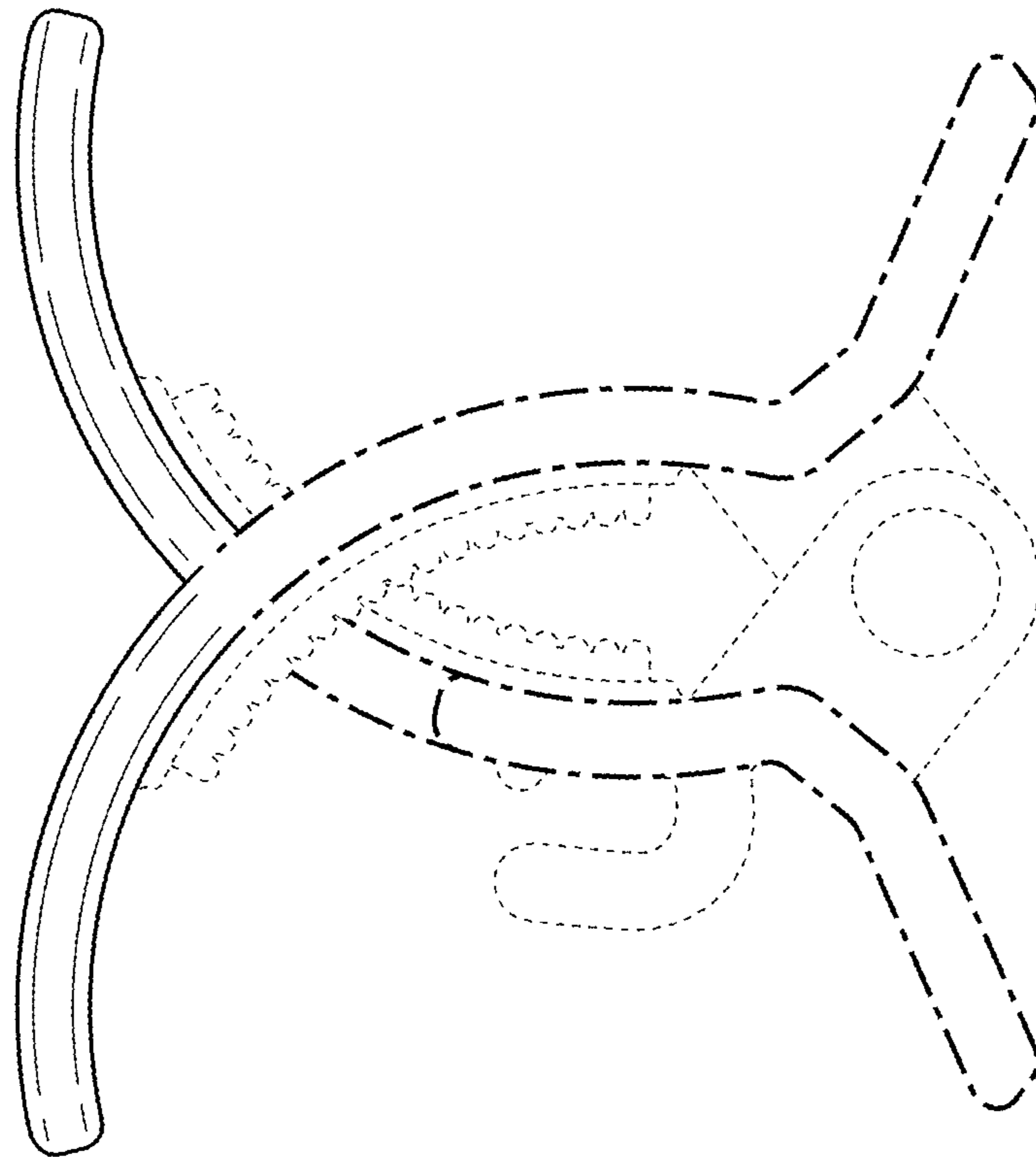

FIG. 7

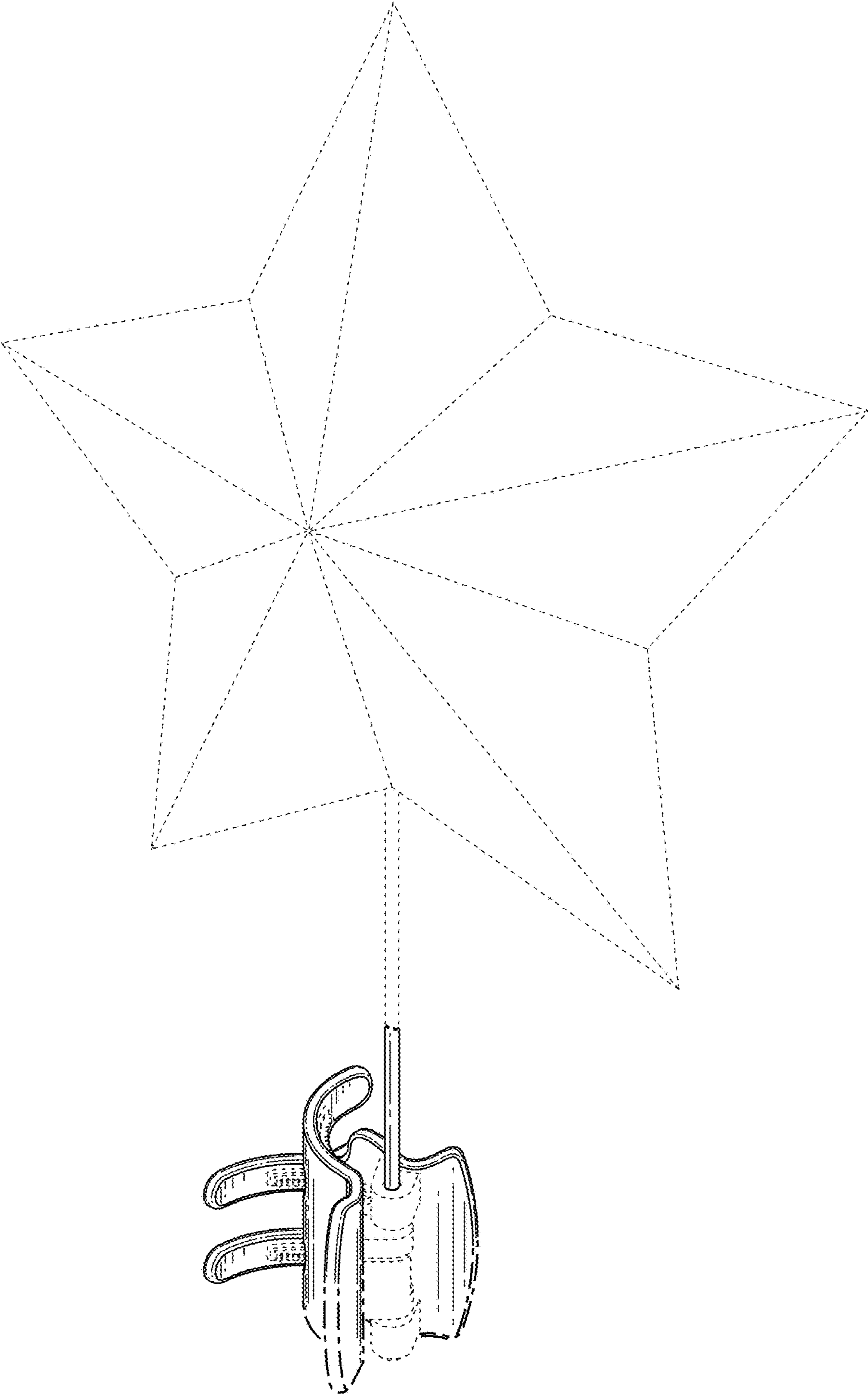

FIG. 8

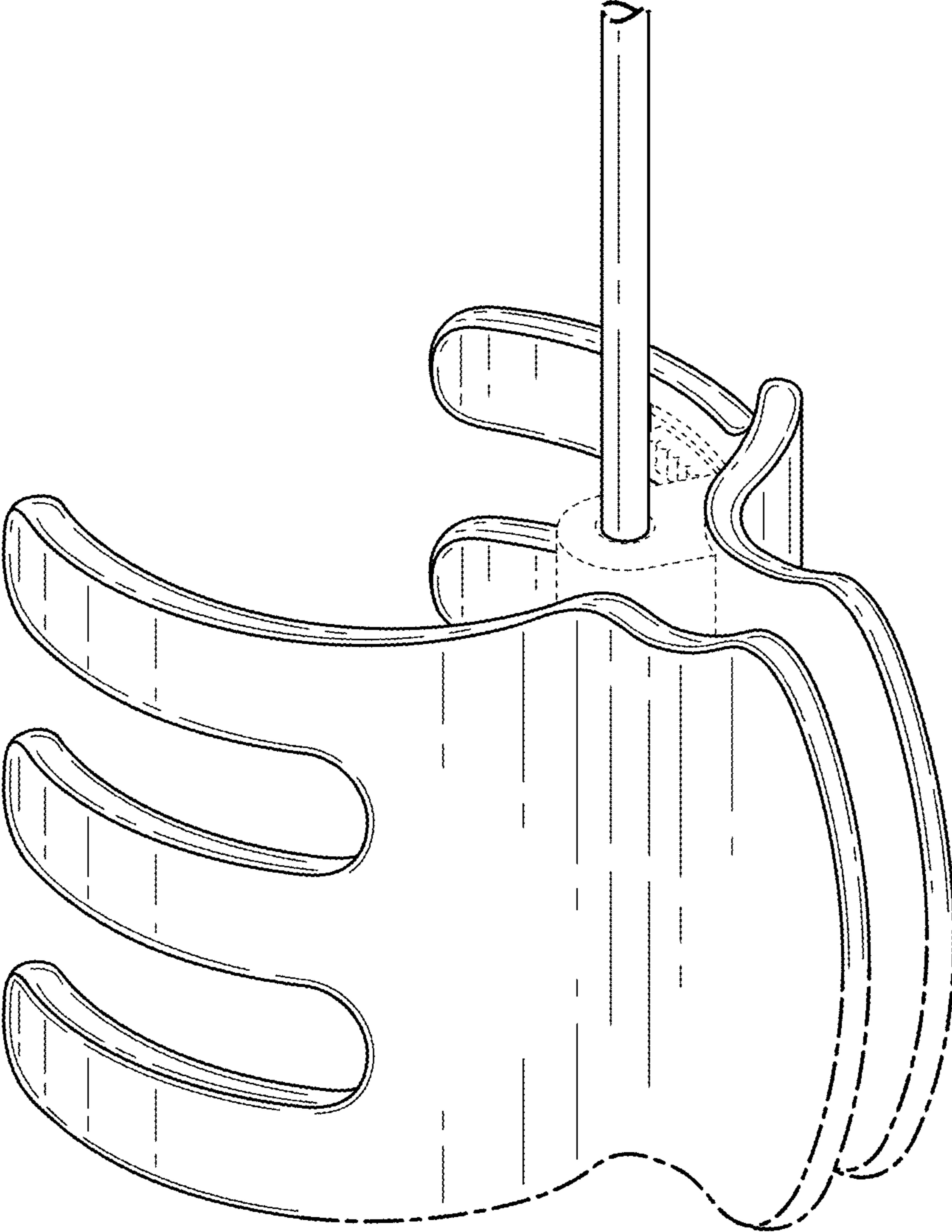

FIG. 9

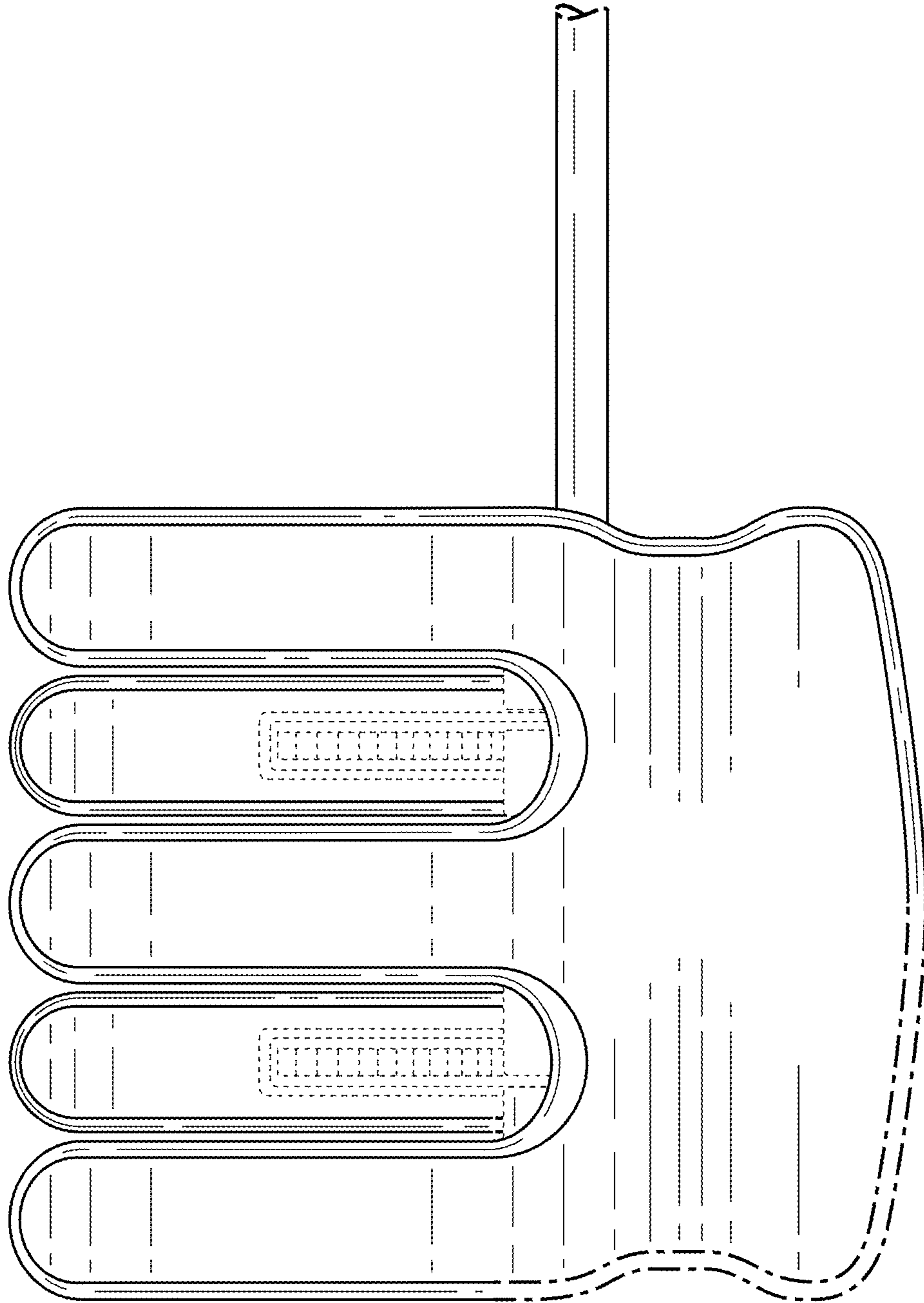

FIG. 10

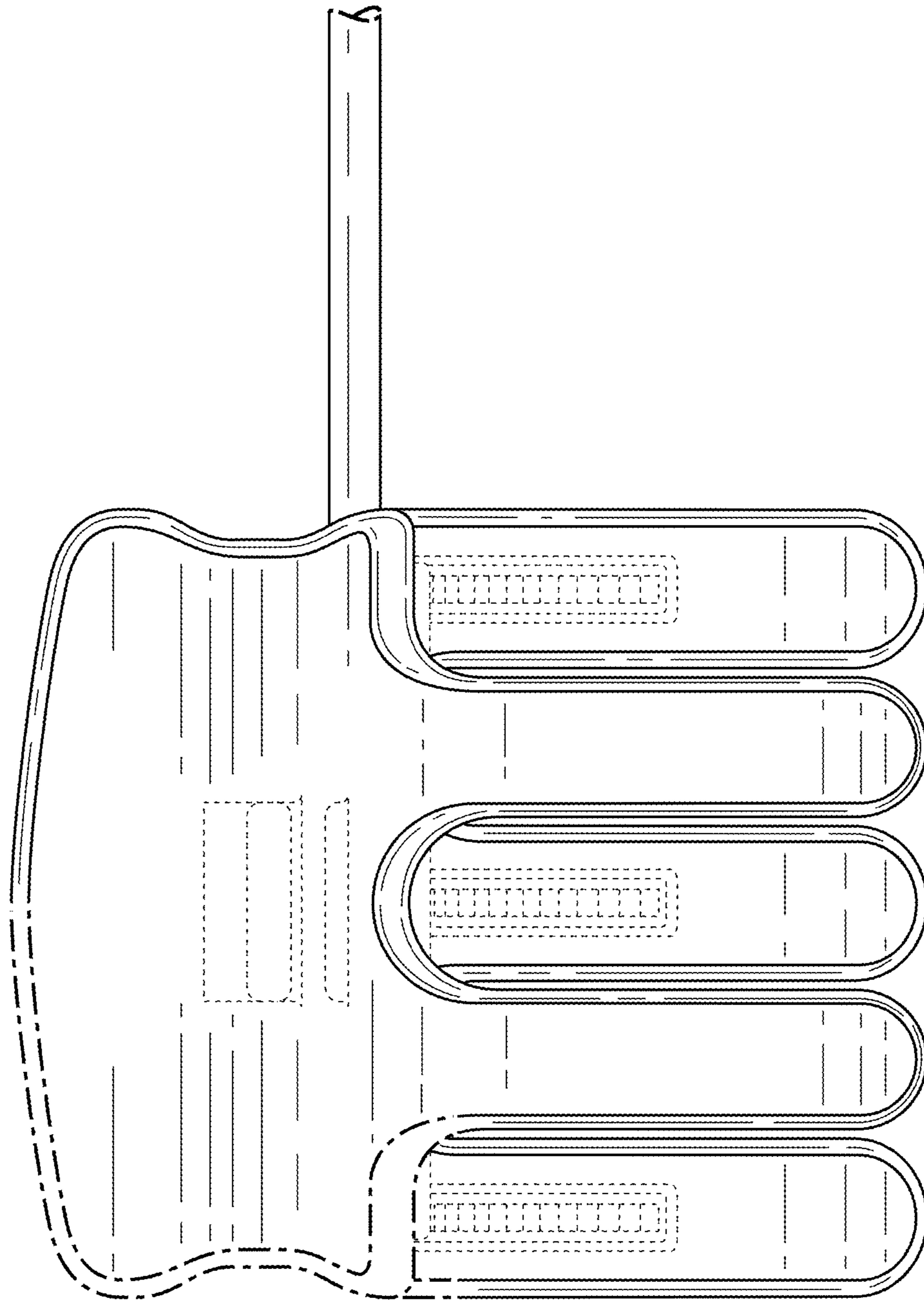

FIG. 11

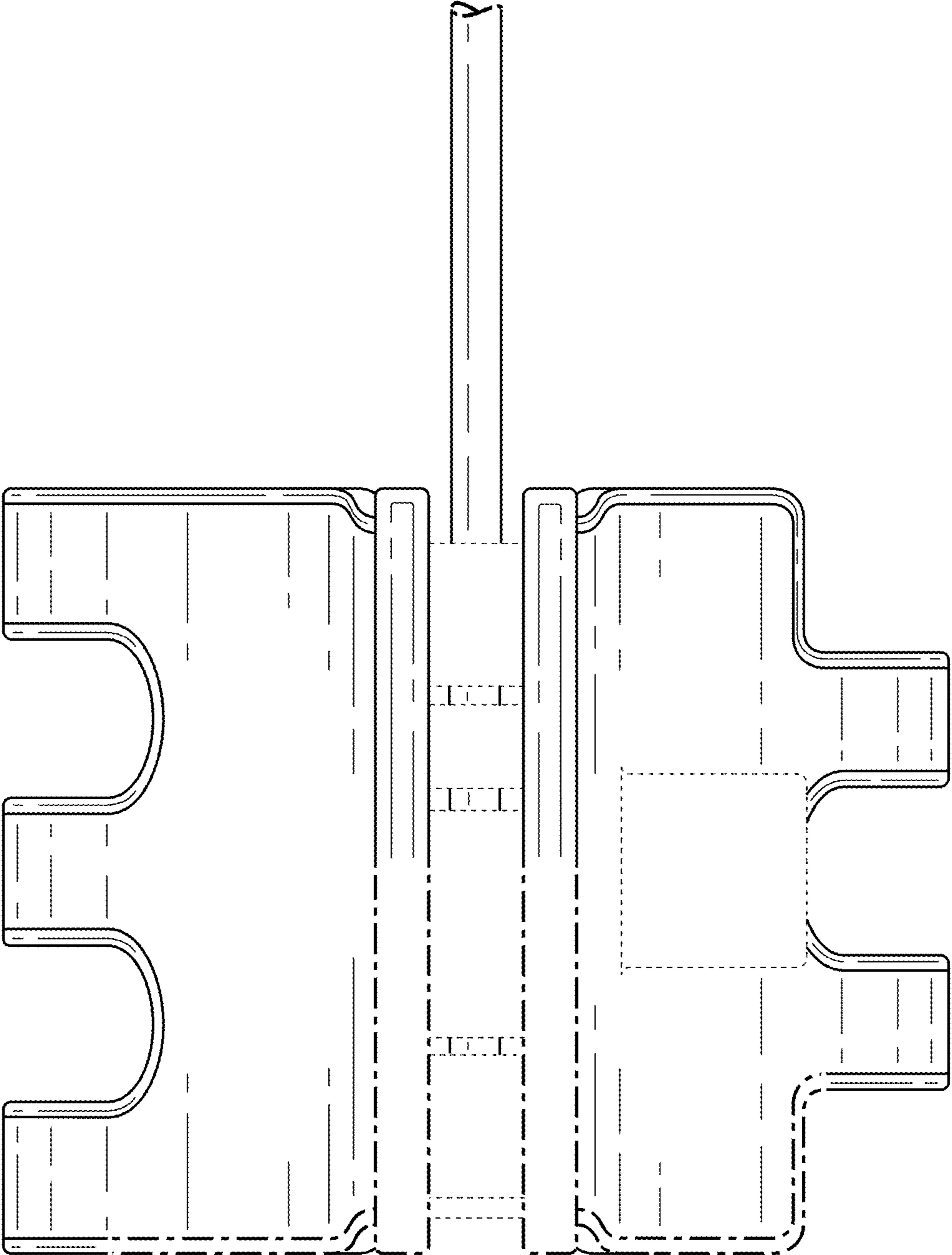

FIG. 12

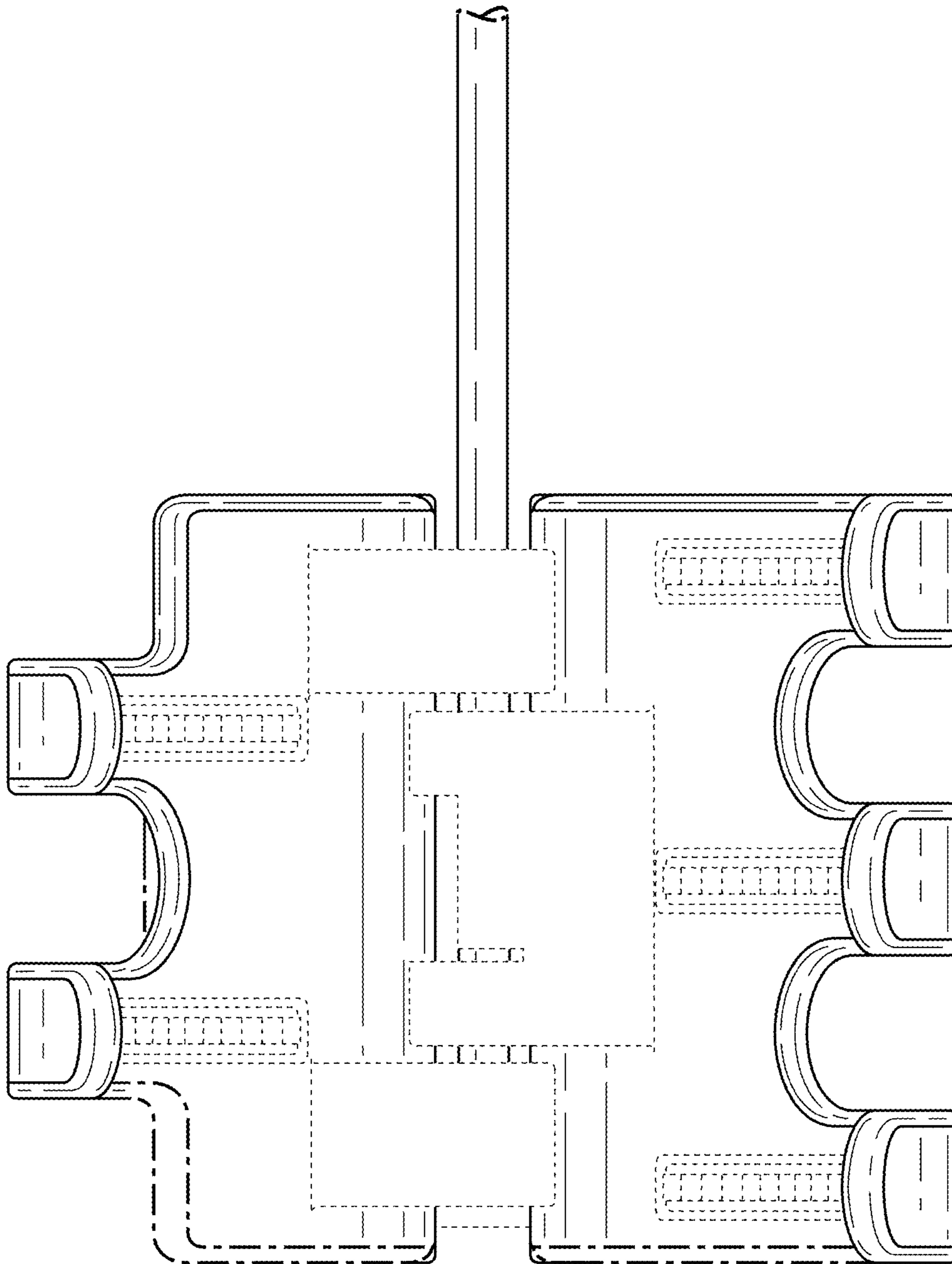

FIG. 13

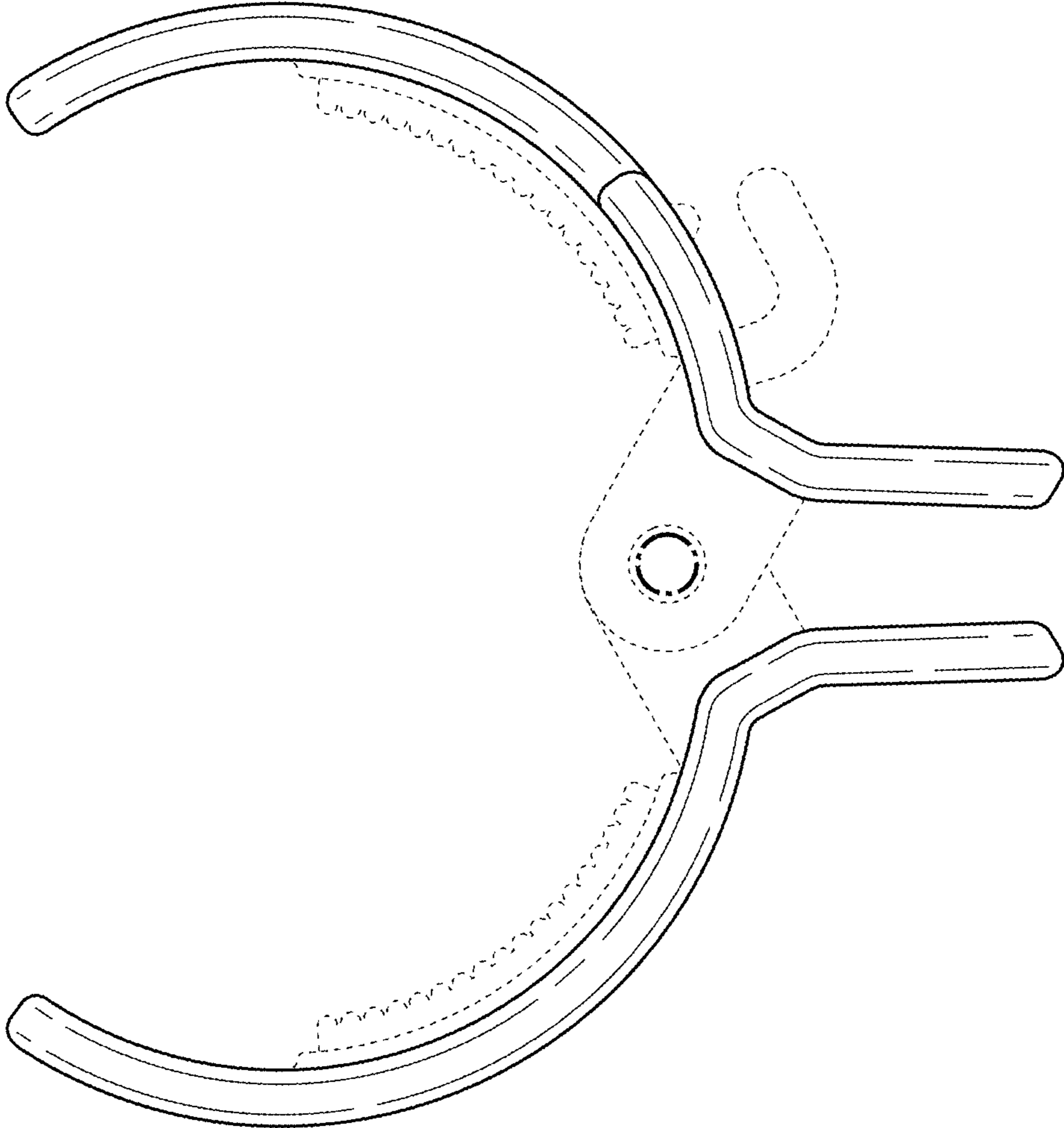

FIG. 14

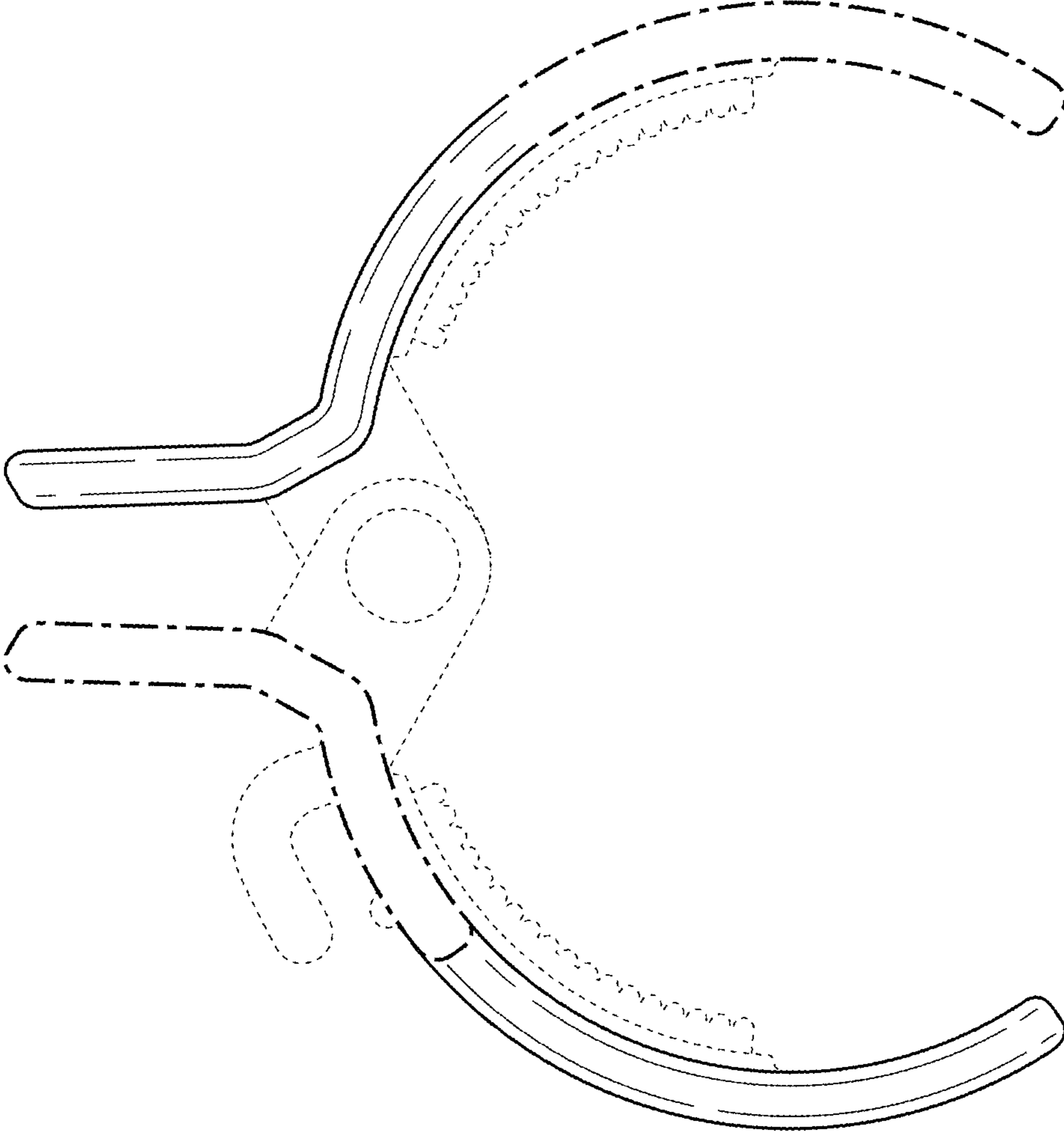

FIG. 15