



US00D777522S

(12) **United States Design Patent**
Vazin

(10) **Patent No.:** **US D777,522 S**

(45) **Date of Patent:** **** *Jan. 31, 2017**

(54) **AVOCADO BOWL**

(71) Applicant: **Moe Vazin**, Riverside, CA (US)

(72) Inventor: **Moe Vazin**, Riverside, CA (US)

(73) Assignee: **American Made Plastic Inc.**,
Riverside, CA (US)

(*) Notice: This patent is subject to a terminal disclaimer.

(**) Term: **14 Years**

(21) Appl. No.: **29/492,476**

(22) Filed: **May 30, 2014**

(51) **LOC (10) Cl.** **07-01**

(52) **U.S. Cl.**
USPC **D7/559; D7/558; D7/503**

(58) **Field of Classification Search**
USPC D7/558, 559, 538, 539, 566, 567, 582,
D7/583, 628, 629, 503; D9/645, 644;
220/574, 575
CPC A21B 3/13; A47J 27/04; A47J 27/05;
A47J 36/02
See application file for complete search history.

(56) **References Cited**

U.S. PATENT DOCUMENTS

D24,184 S *	4/1895	Berry	D7/539
D43,041 S *	9/1912	Haley	D7/558
D70,865 S *	8/1926	Taudte	D7/538
D163,531 S *	6/1951	McCarron	D7/325
D165,821 S *	2/1952	Brahm	D7/538
D168,092 S *	11/1952	Hedu	D11/153
D198,057 S *	4/1964	Swett	D7/629
D375,258 S *	11/1996	Weder	D9/414
D383,671 S *	9/1997	Phillips	D7/629
D390,104 S *	2/1998	Owen	D7/628
6,431,389 B1 *	8/2002	Jerstroem	A47J 36/02 220/574
D469,320 S *	1/2003	Pettaweebuncha	D7/629
D547,115 S *	7/2007	Bouveret	D7/392.1

D582,718 S *	12/2008	Chandler	D7/360
D618,512 S *	6/2010	Kimmel	D7/554.2
D653,916 S *	2/2012	Ablo	D7/629
D656,366 S *	3/2012	Abrams	D7/628
D683,596 S *	6/2013	Ellerstorfer	D7/629
D706,131 S *	6/2014	Brooks	D9/428
D710,146 S *	8/2014	Carlson	D7/391
D723,874 S *	3/2015	Marques	D7/558

* cited by examiner

Primary Examiner — Marianne Pandozzi
(74) *Attorney, Agent, or Firm* — Smyrski Law Group,
A.P.C.

(57) **CLAIM**

The ornamental design of avocado bowl, as shown and described.

DESCRIPTION

FIG. 1 is a perspective view of an avocado bowl showing a first embodiment of our new design;
FIG. 2 is a front view thereof;
FIG. 3 is a side view thereof;
FIG. 4 is a rear view thereof;
FIG. 5 is a top plan view thereof;
FIG. 6 is a bottom plan view thereof;
FIG. 7 is a perspective view of an avocado bowl showing a second embodiment of the new design;
FIG. 8 is a front view thereof;
FIG. 9 is a side view thereof;
FIG. 10 is a rear view thereof;
FIG. 11 is a top plan view thereof;
FIG. 12 is a bottom plan view thereof;
FIG. 13 is a perspective view of an avocado bowl showing a third embodiment of our new design;
FIG. 14 is a front view thereof;
FIG. 15 is a side view thereof;
FIG. 16 is a rear view thereof;
FIG. 17 is a top plan view thereof; and,
FIG. 18 is a bottom plan view thereof.

1 Claim, 18 Drawing Sheets

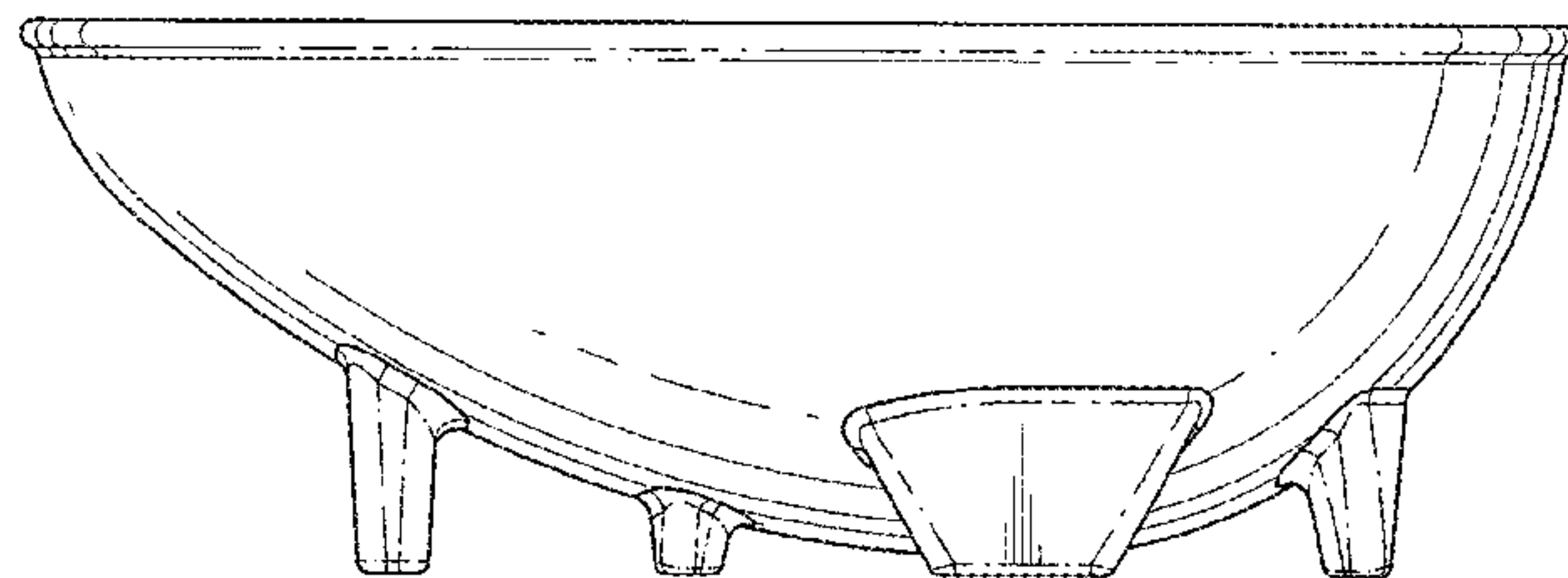
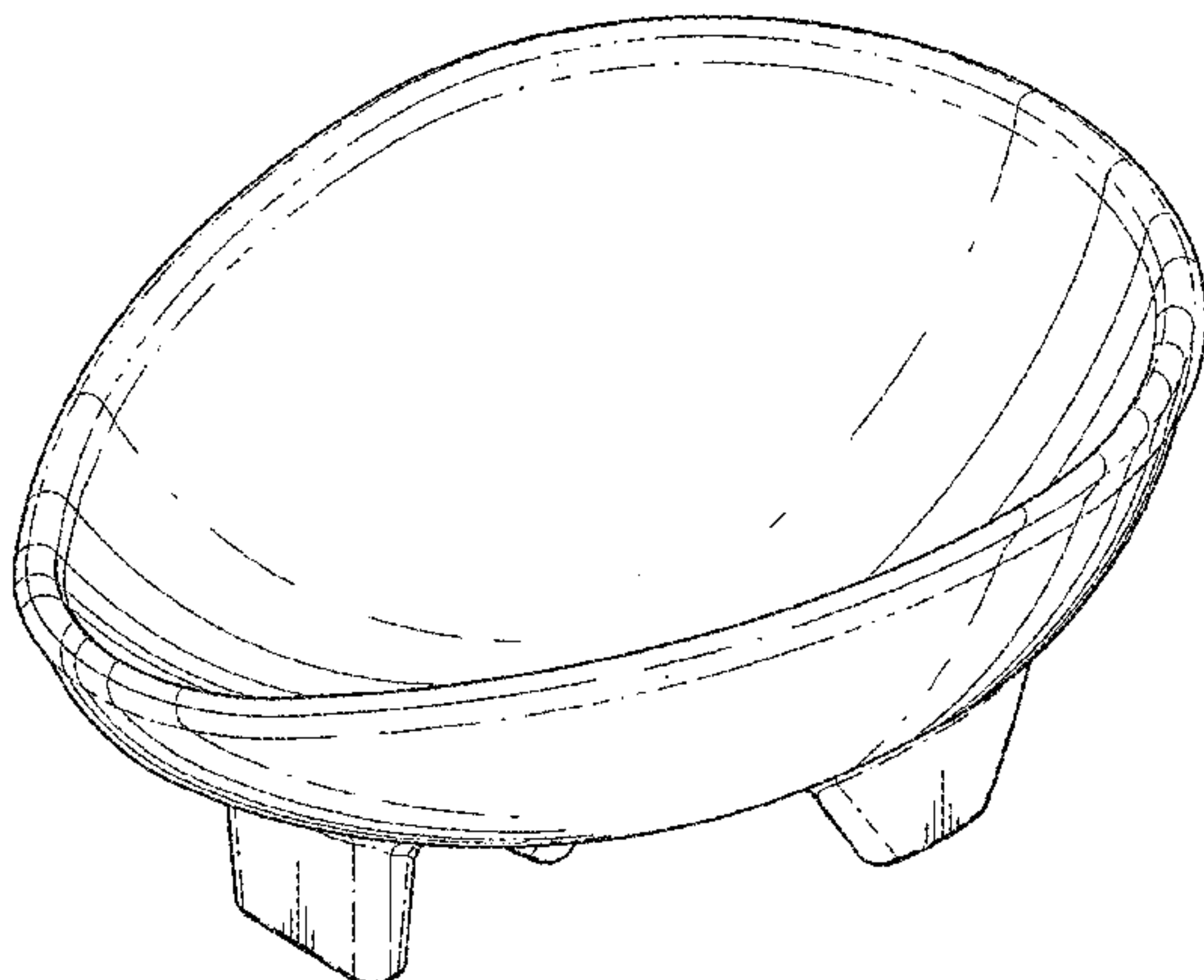

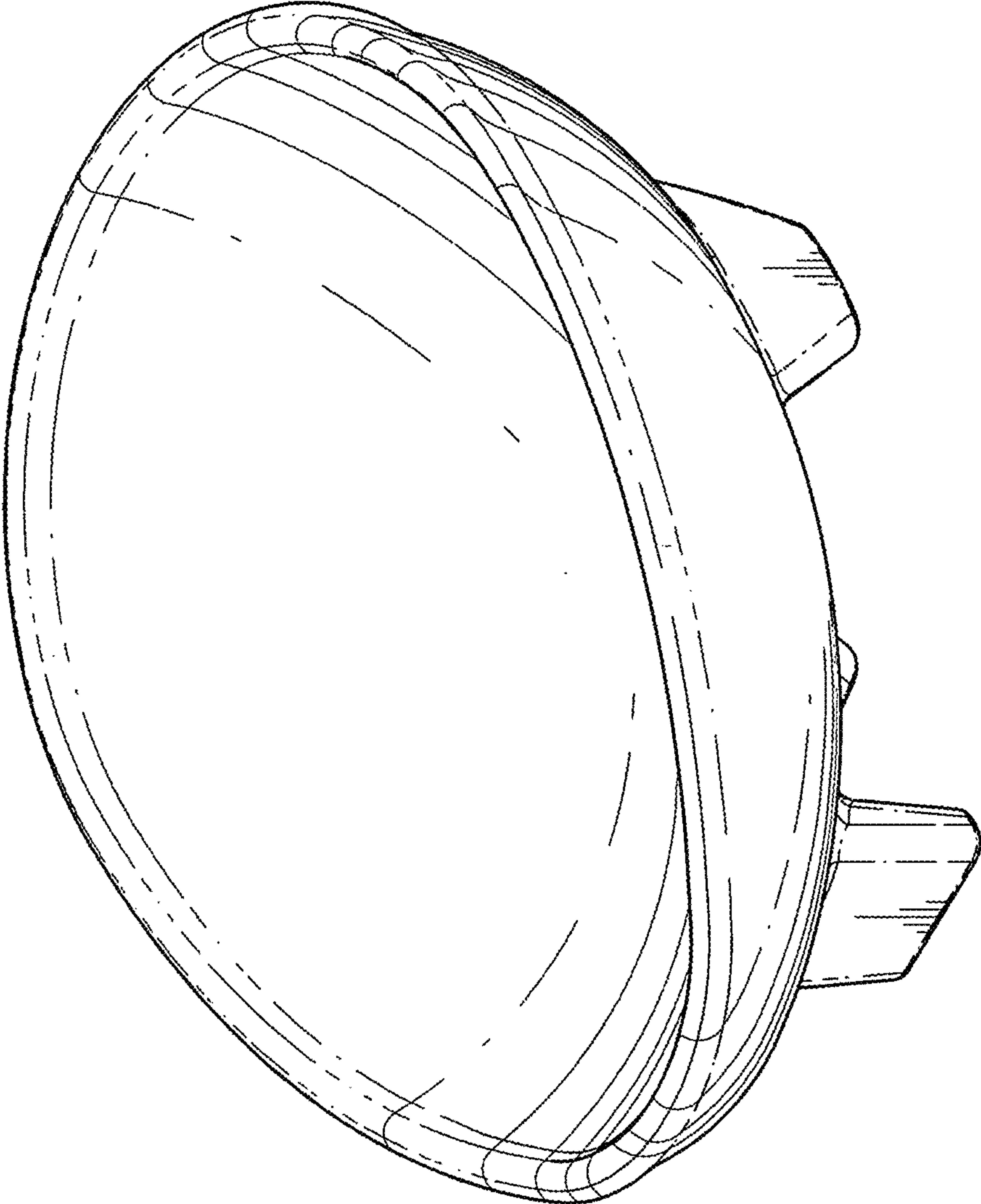

FIG. 1

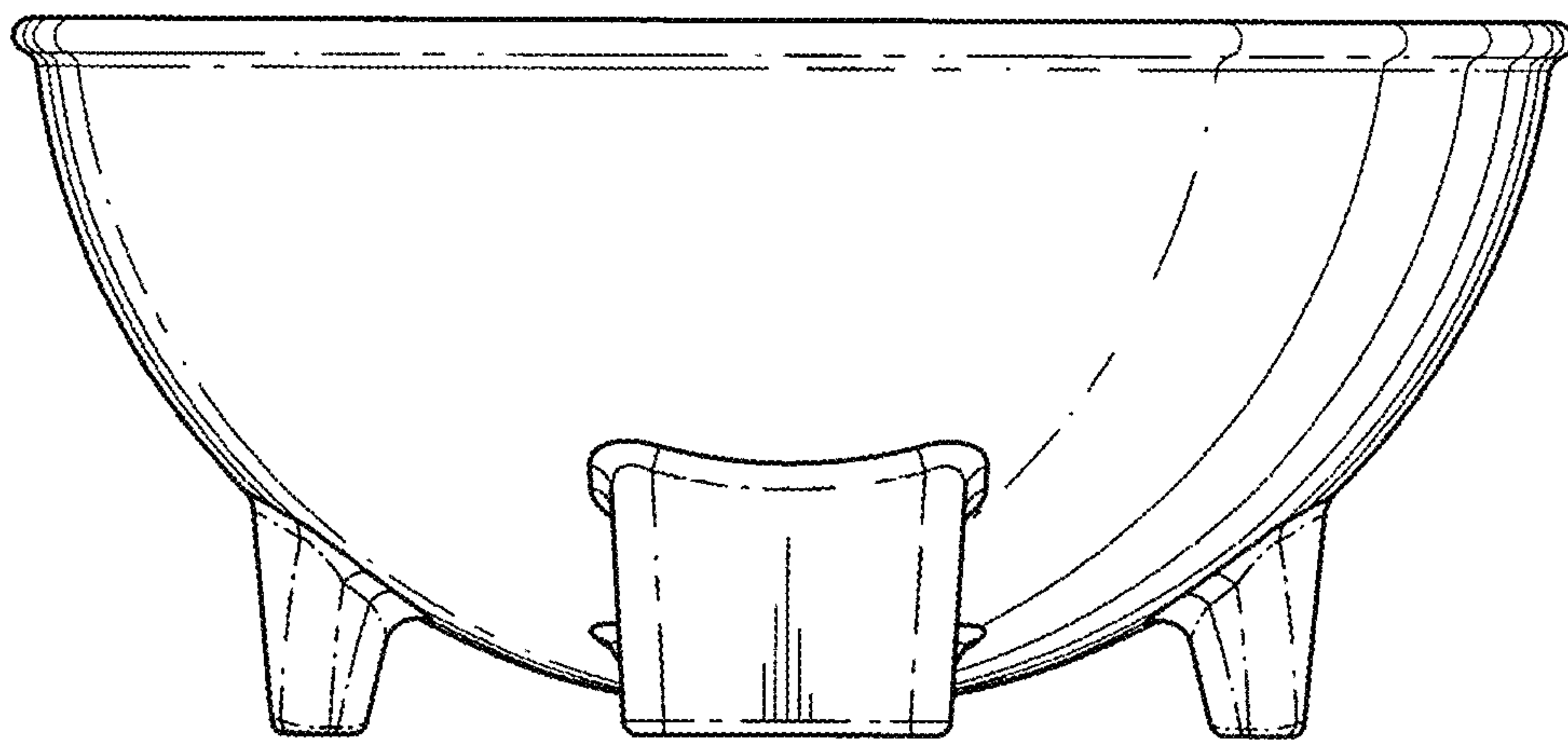

FIG. 2

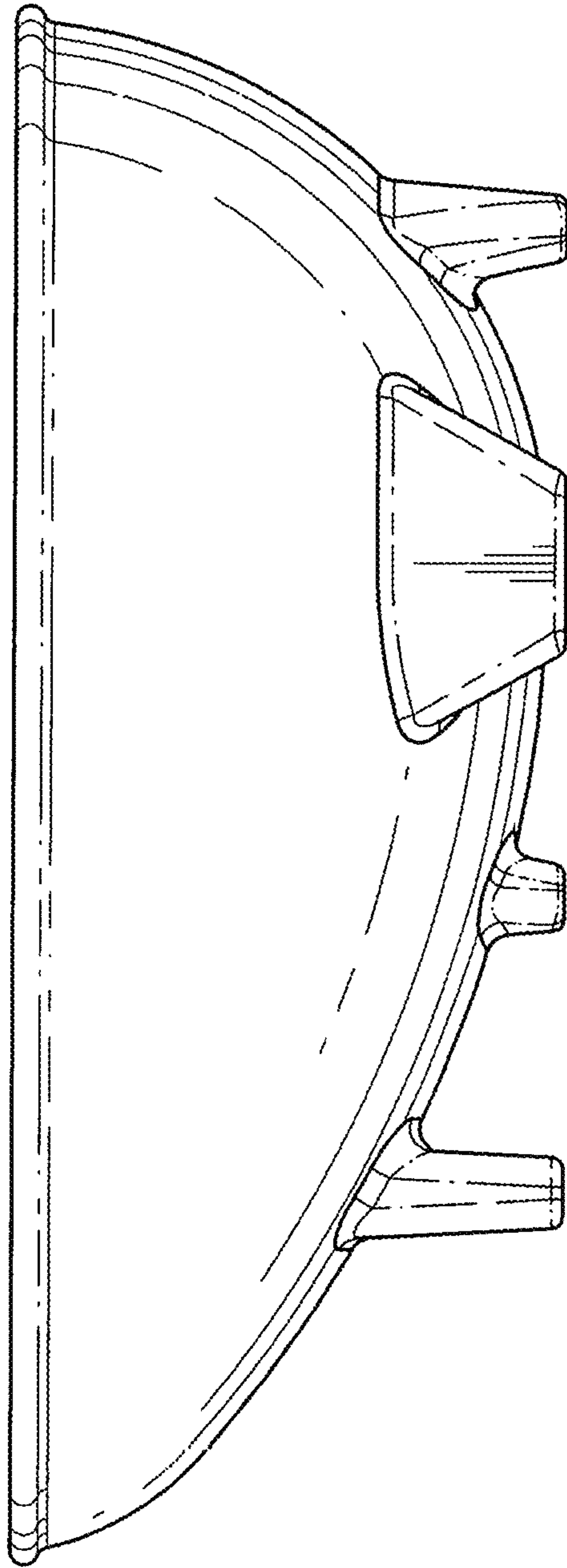

FIG. 3

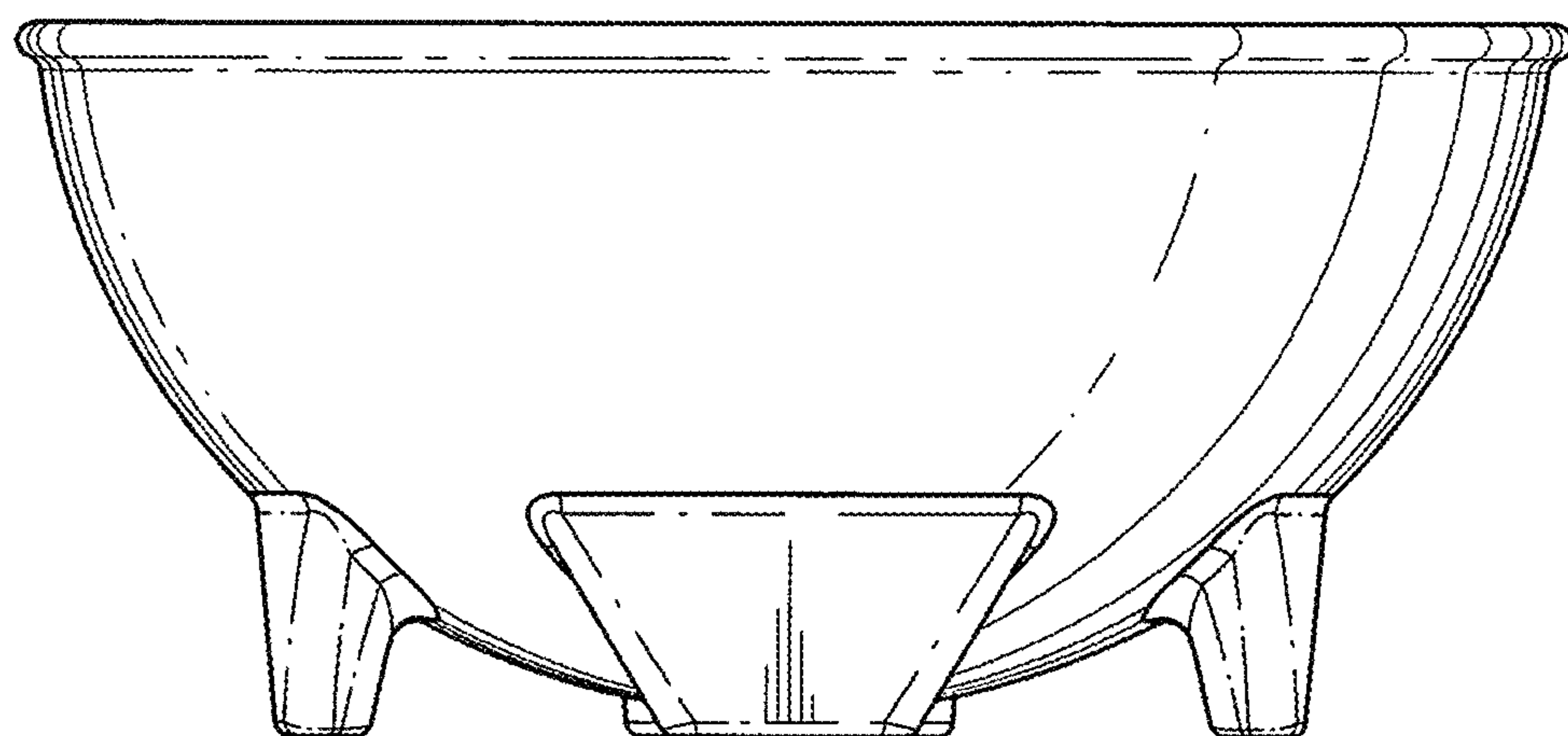

FIG. 4

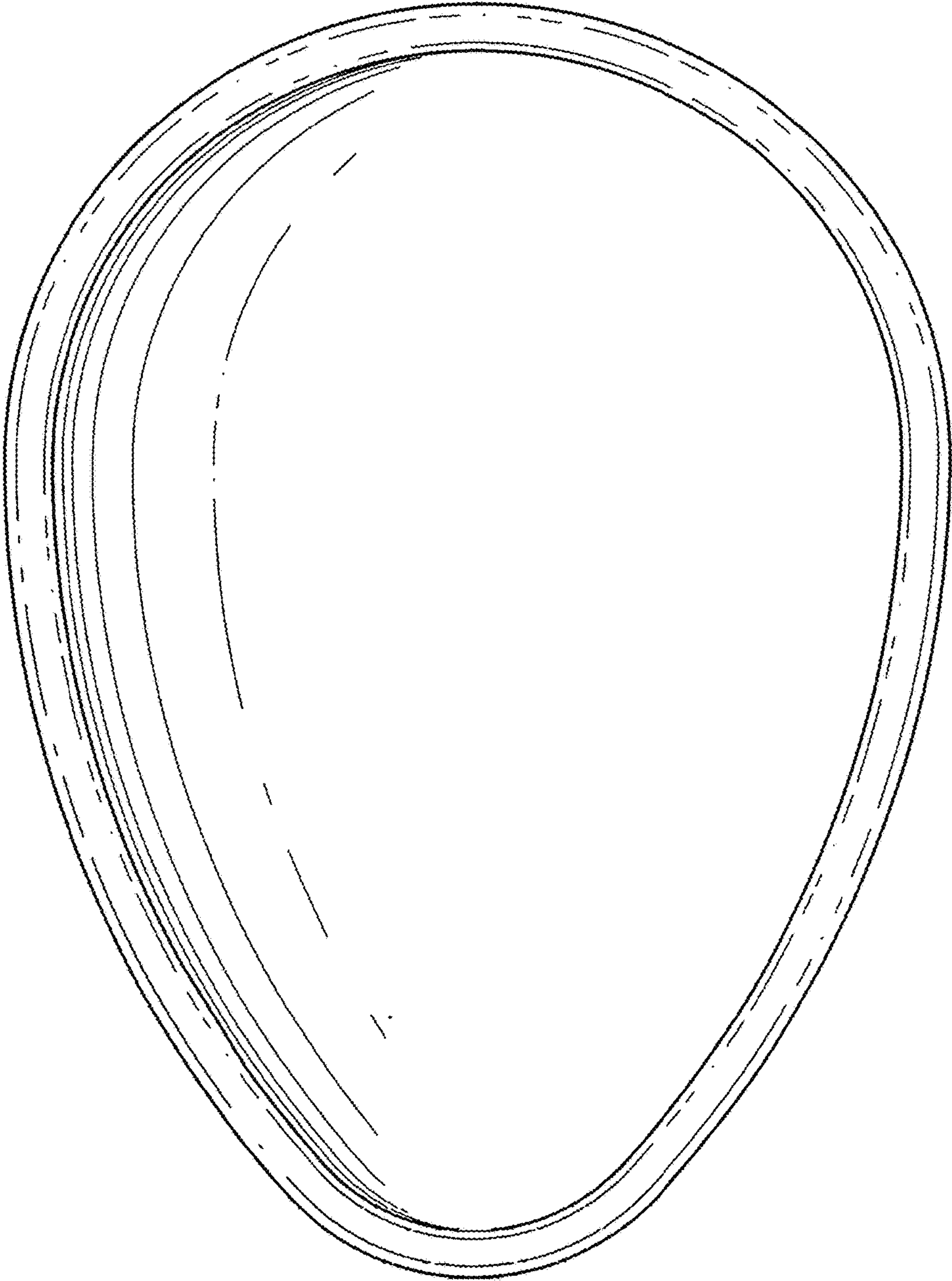

FIG. 5

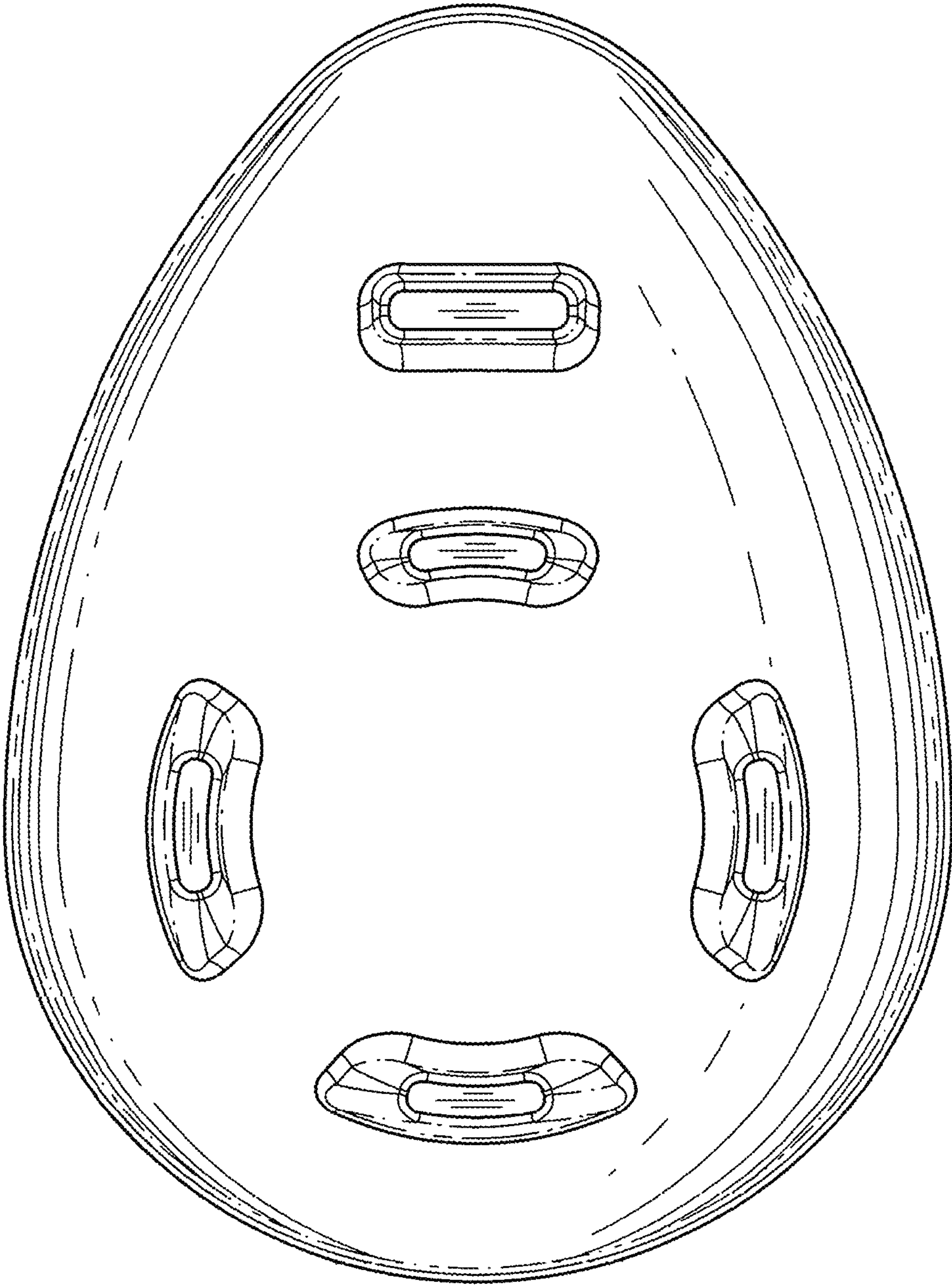

FIG. 6

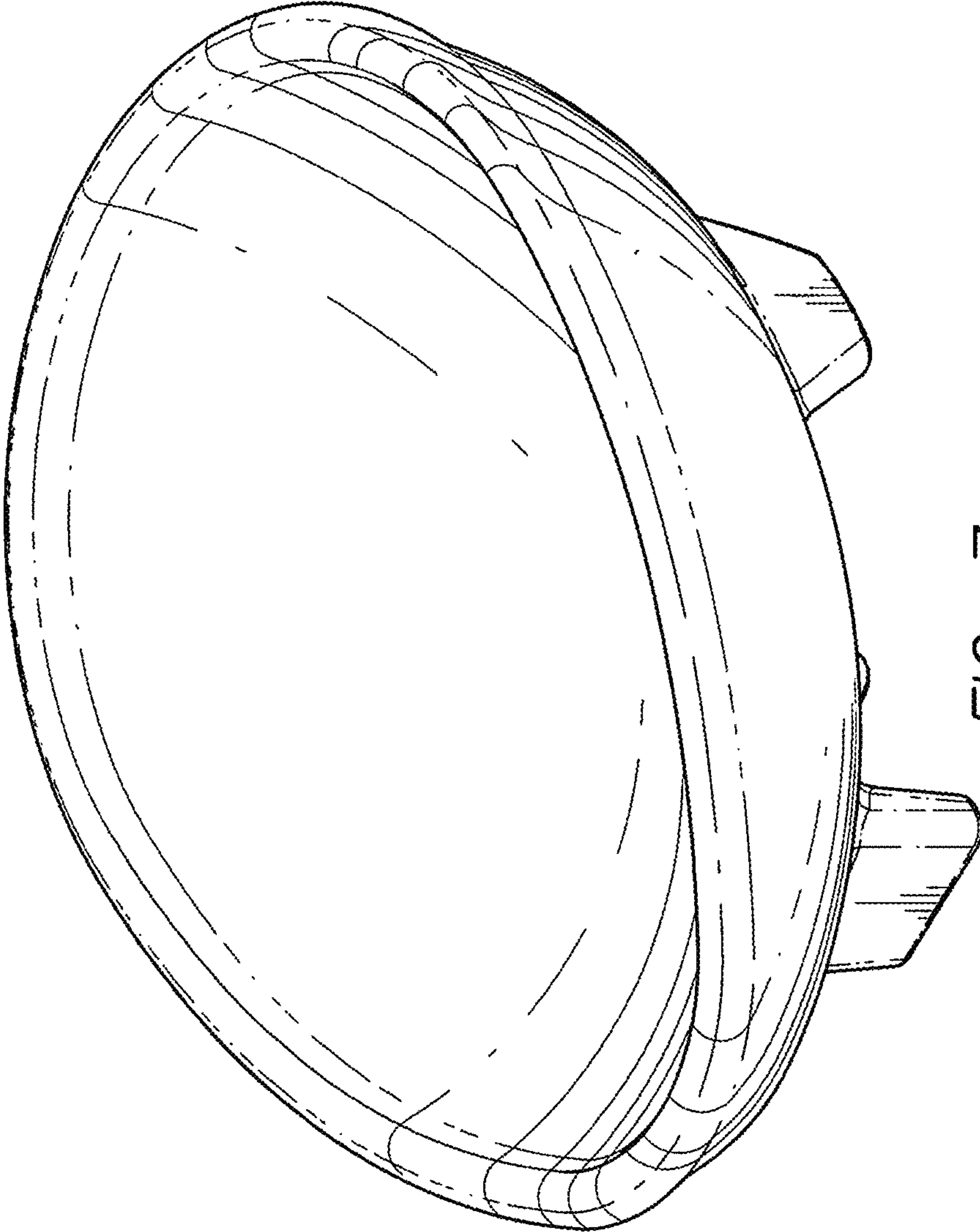

FIG. 7

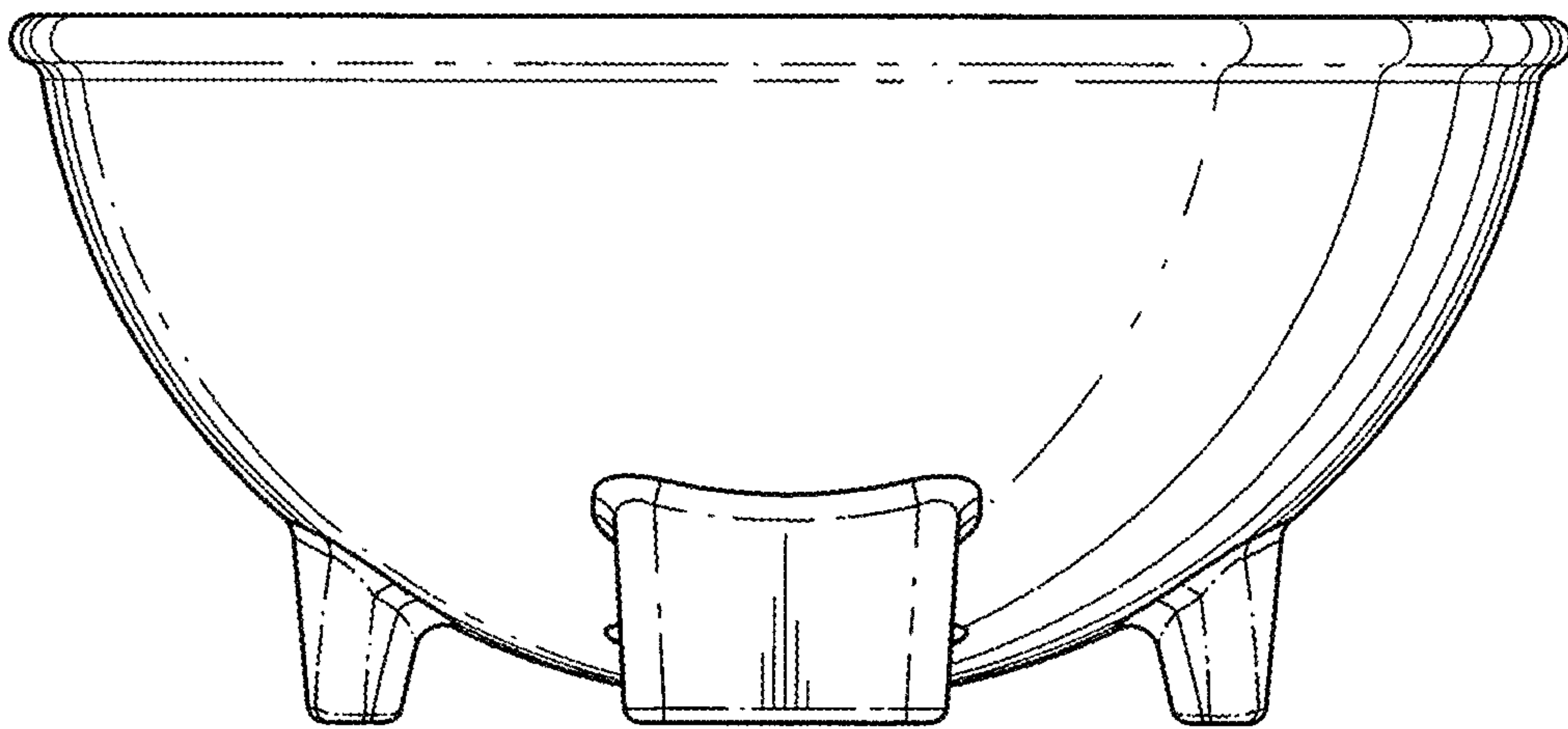

FIG. 8

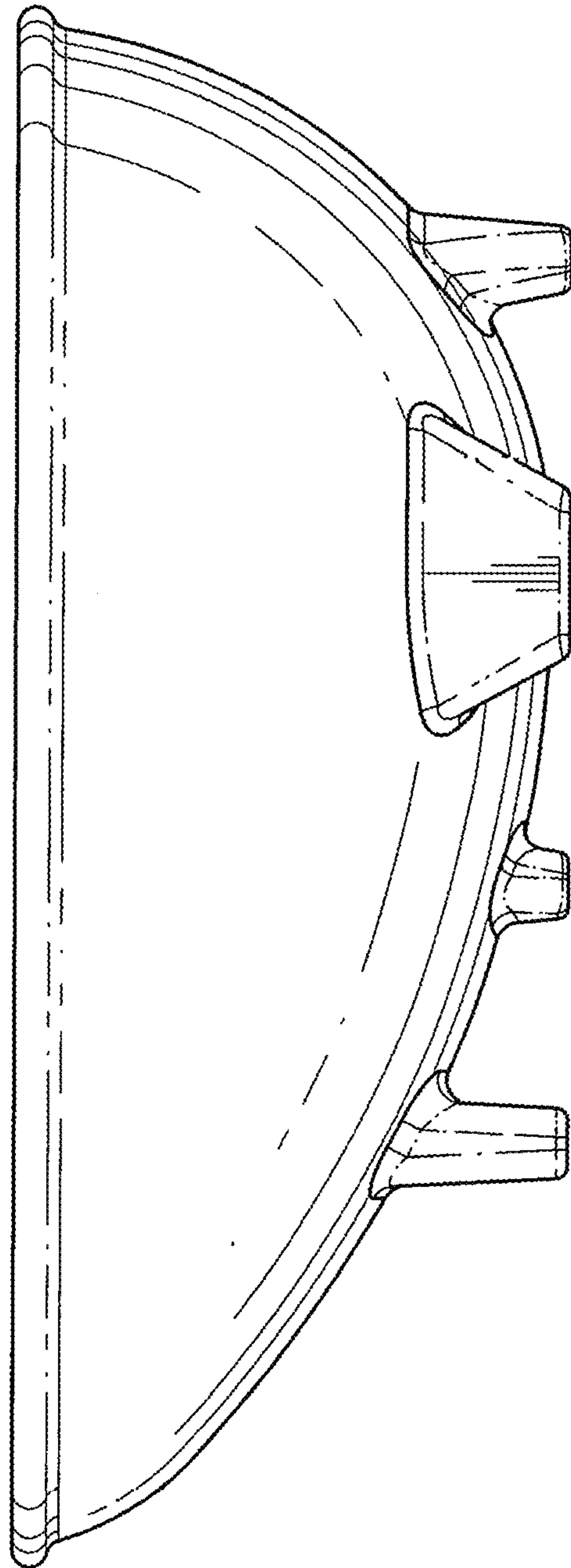

FIG. 9

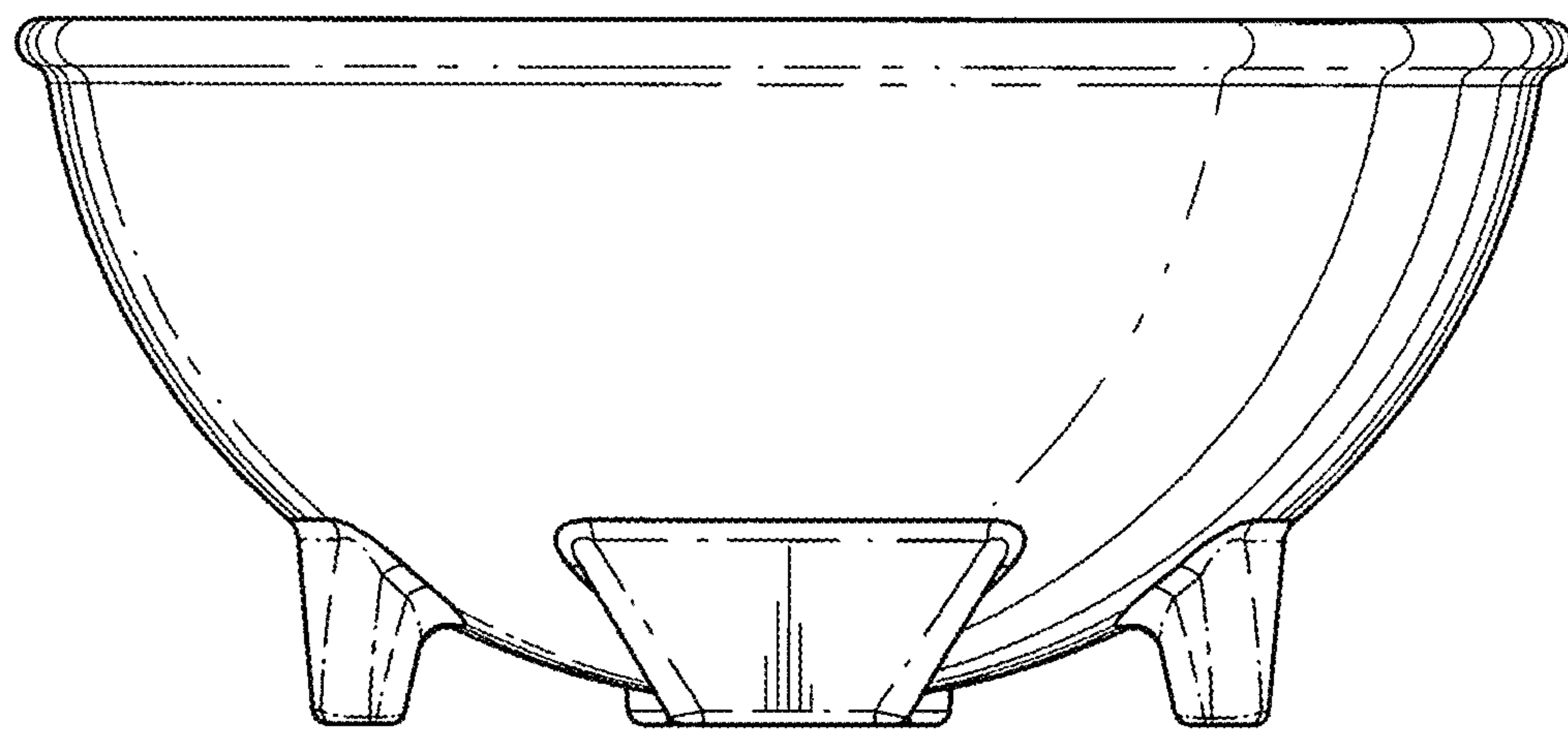

FIG. 10

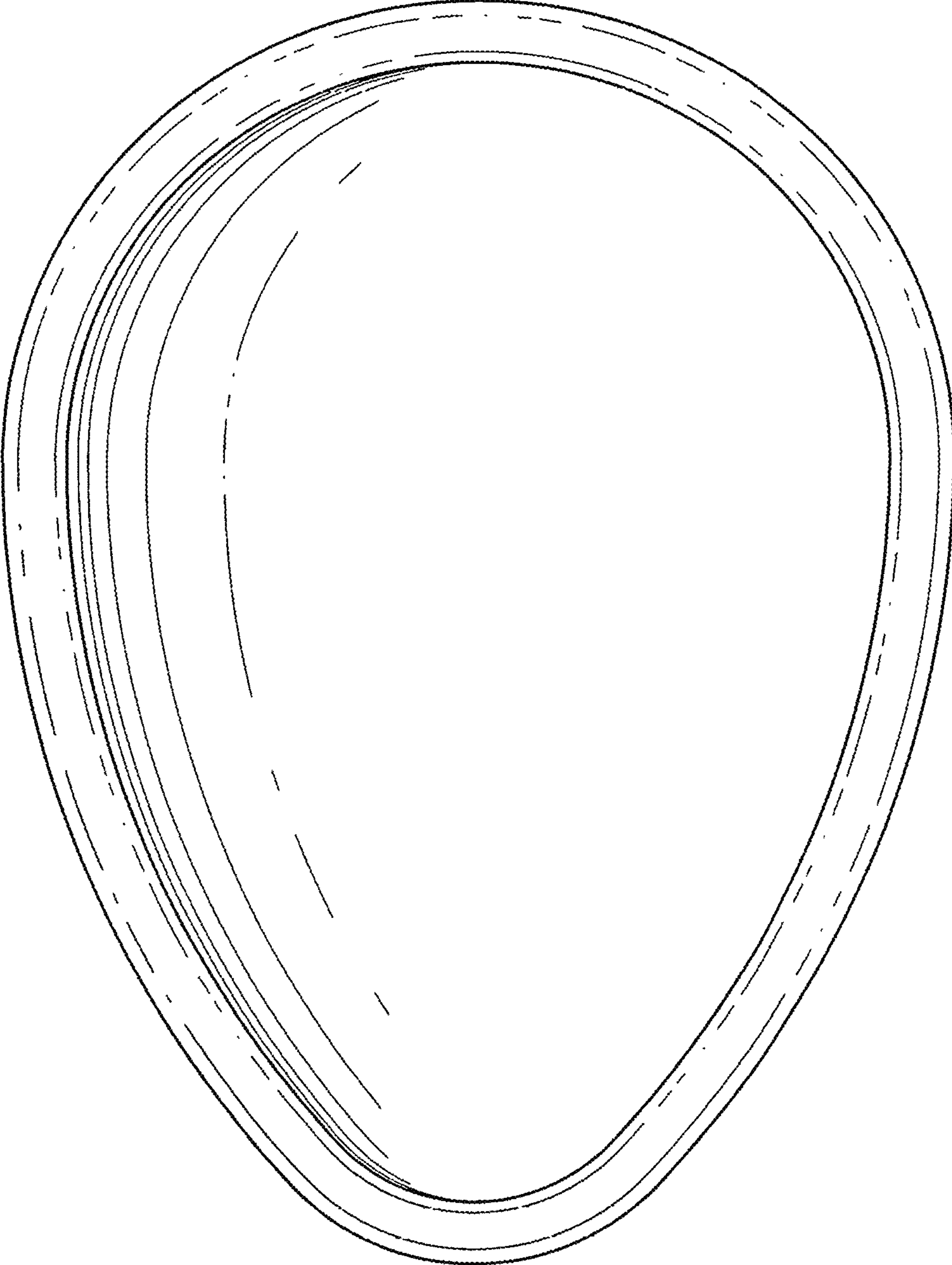

FIG. 11

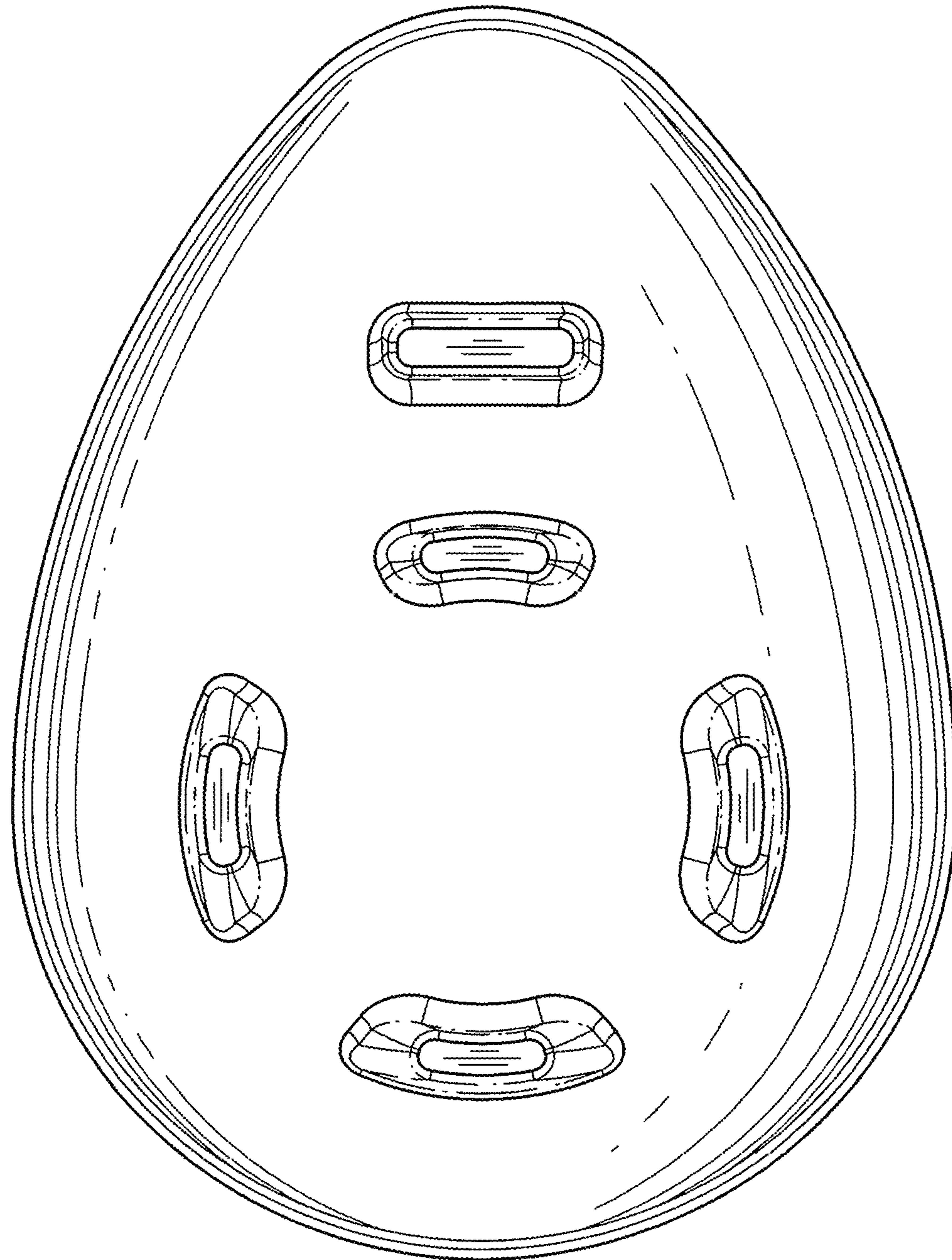

FIG. 12

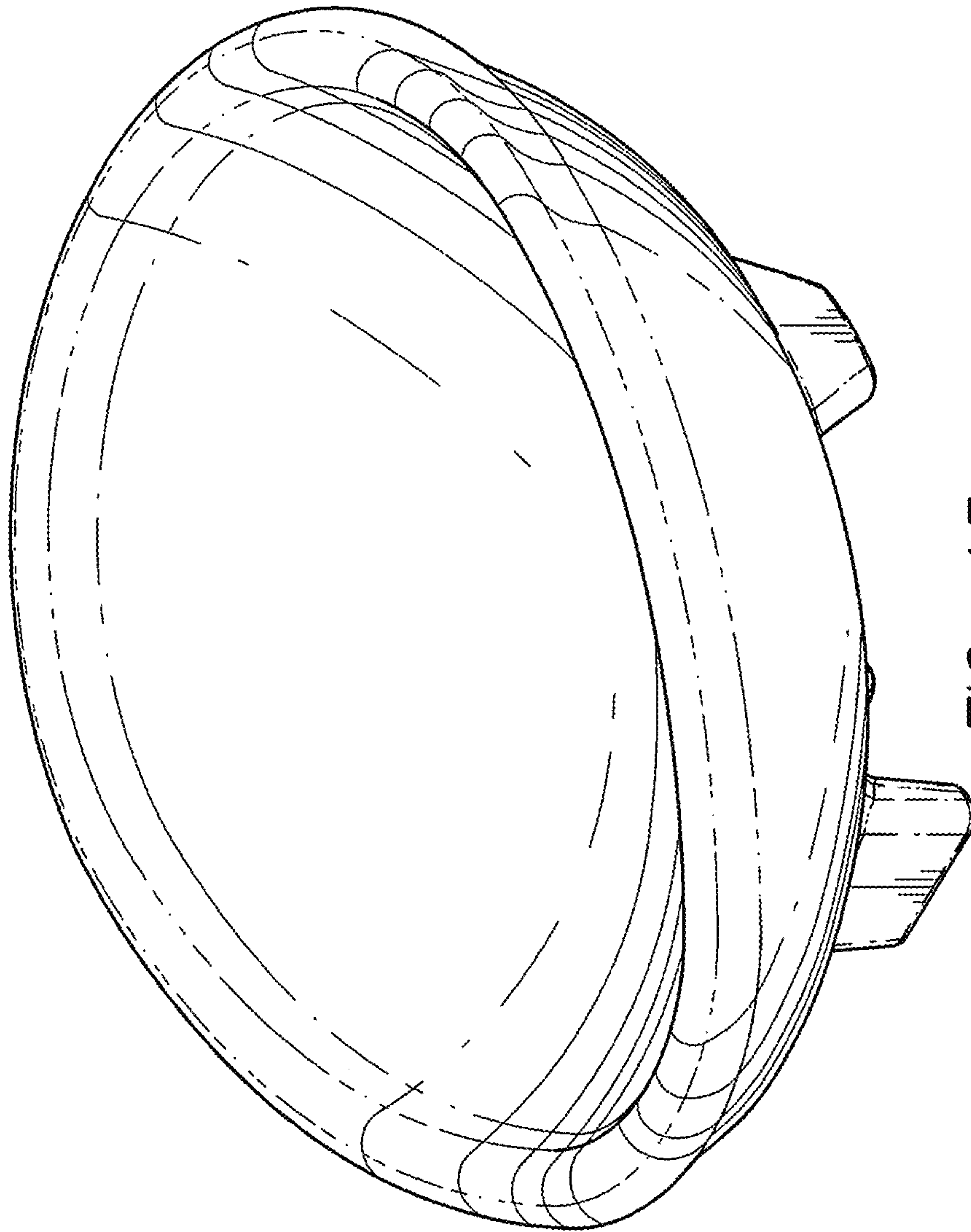

FIG. 13

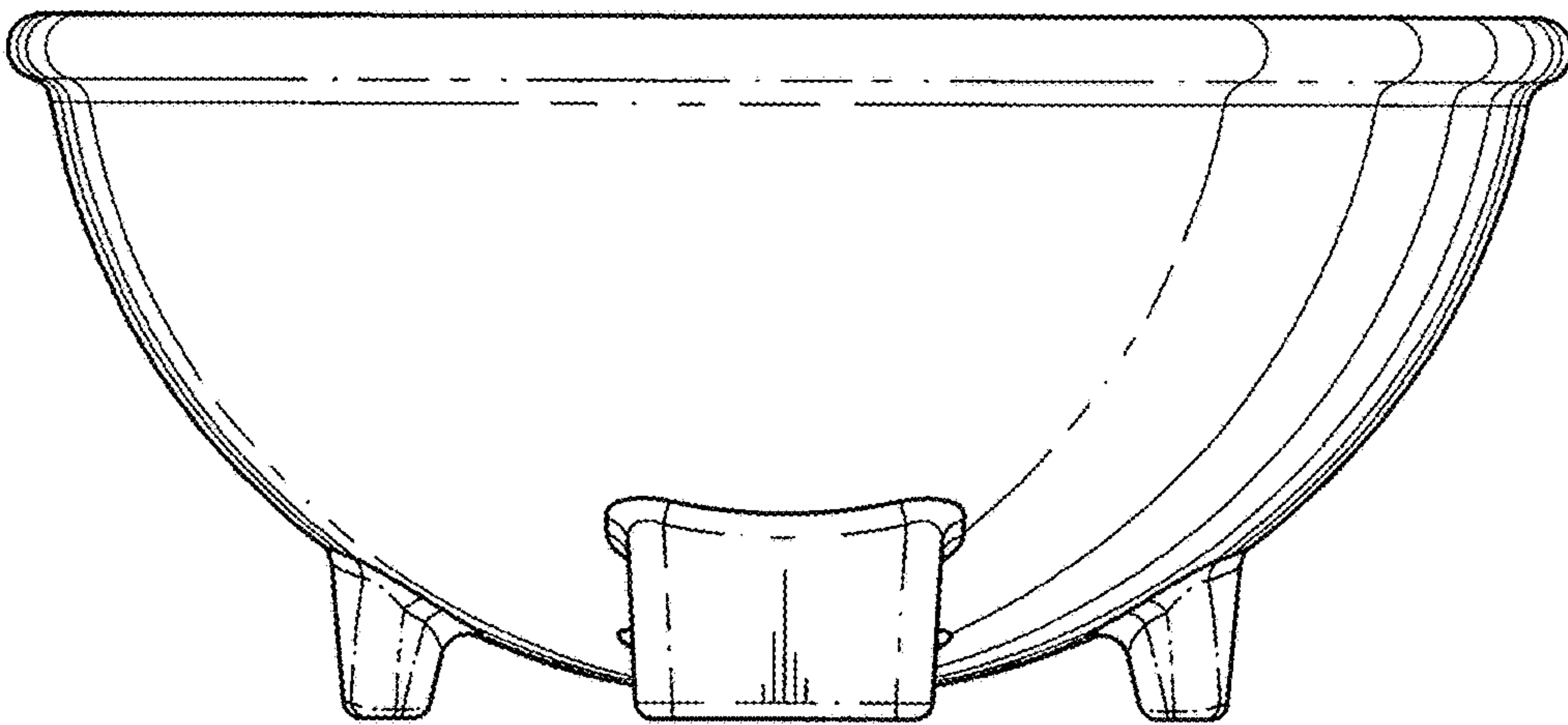

FIG. 14

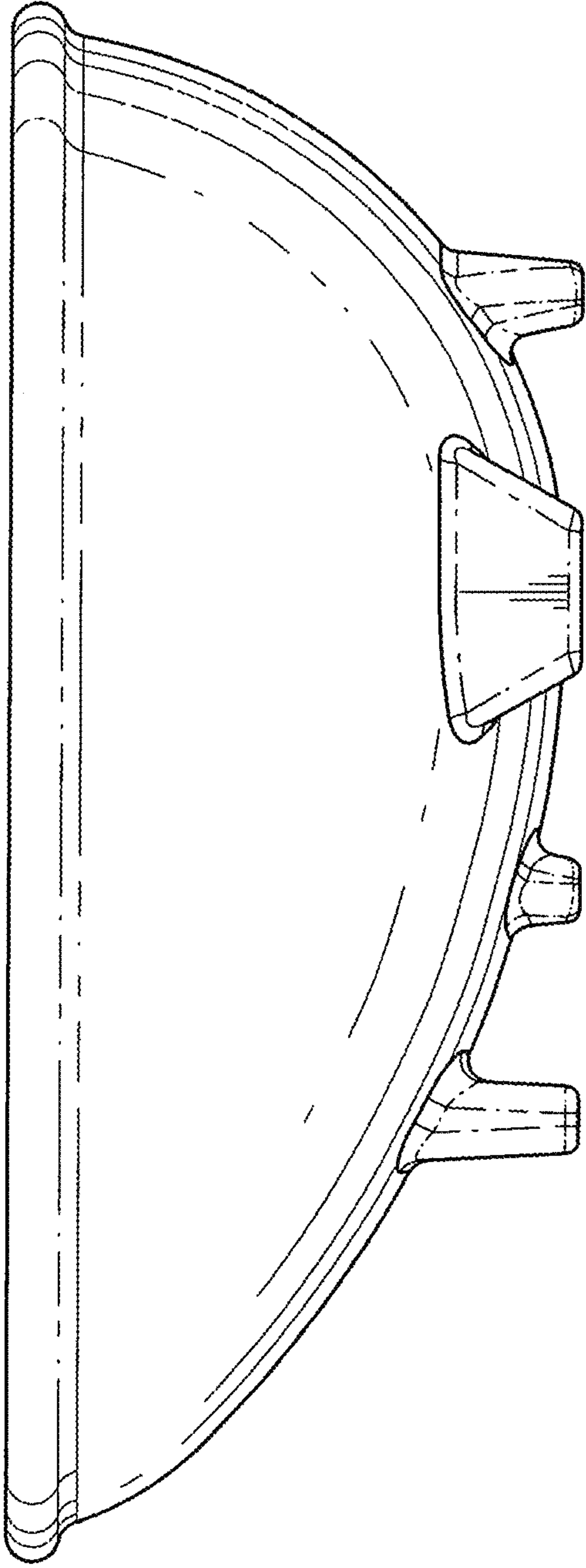

FIG. 15

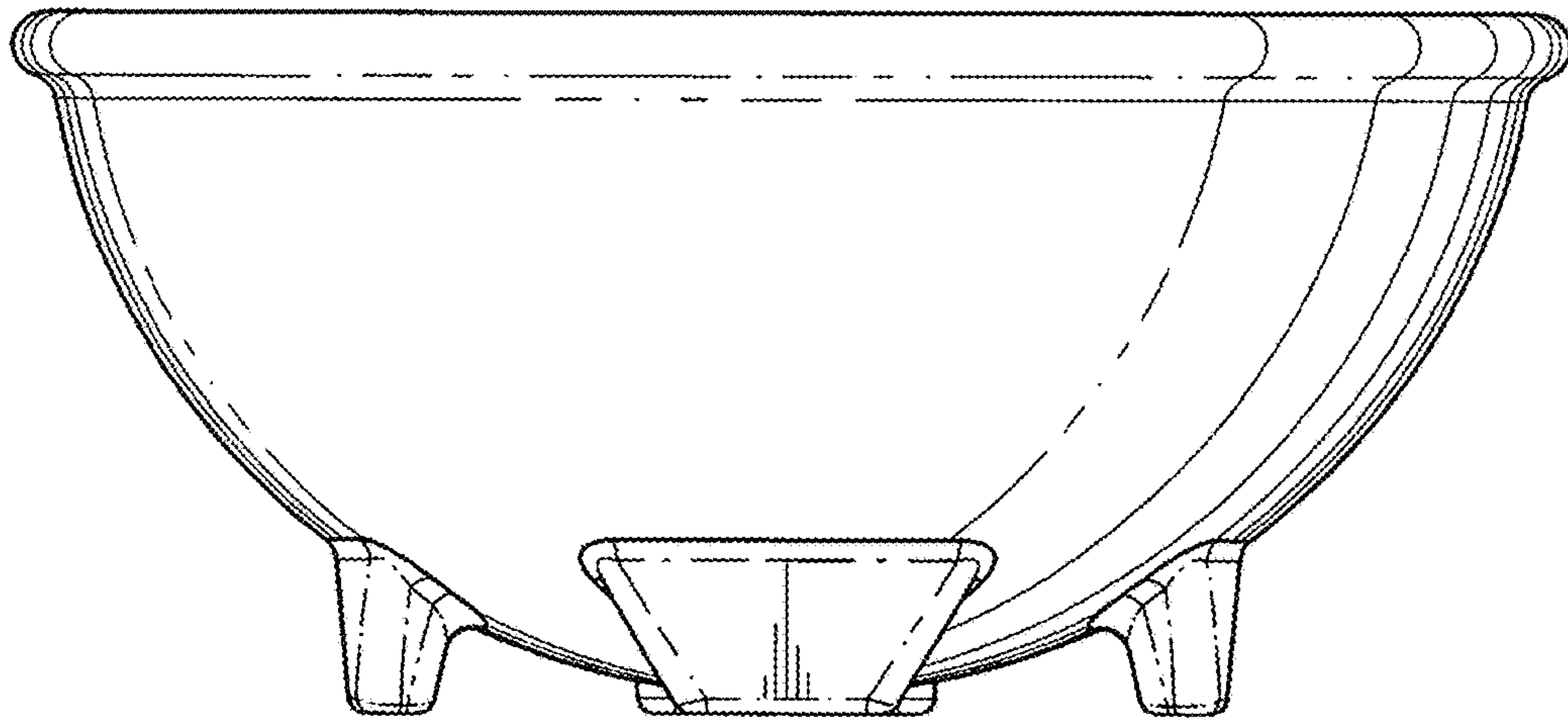

FIG. 16

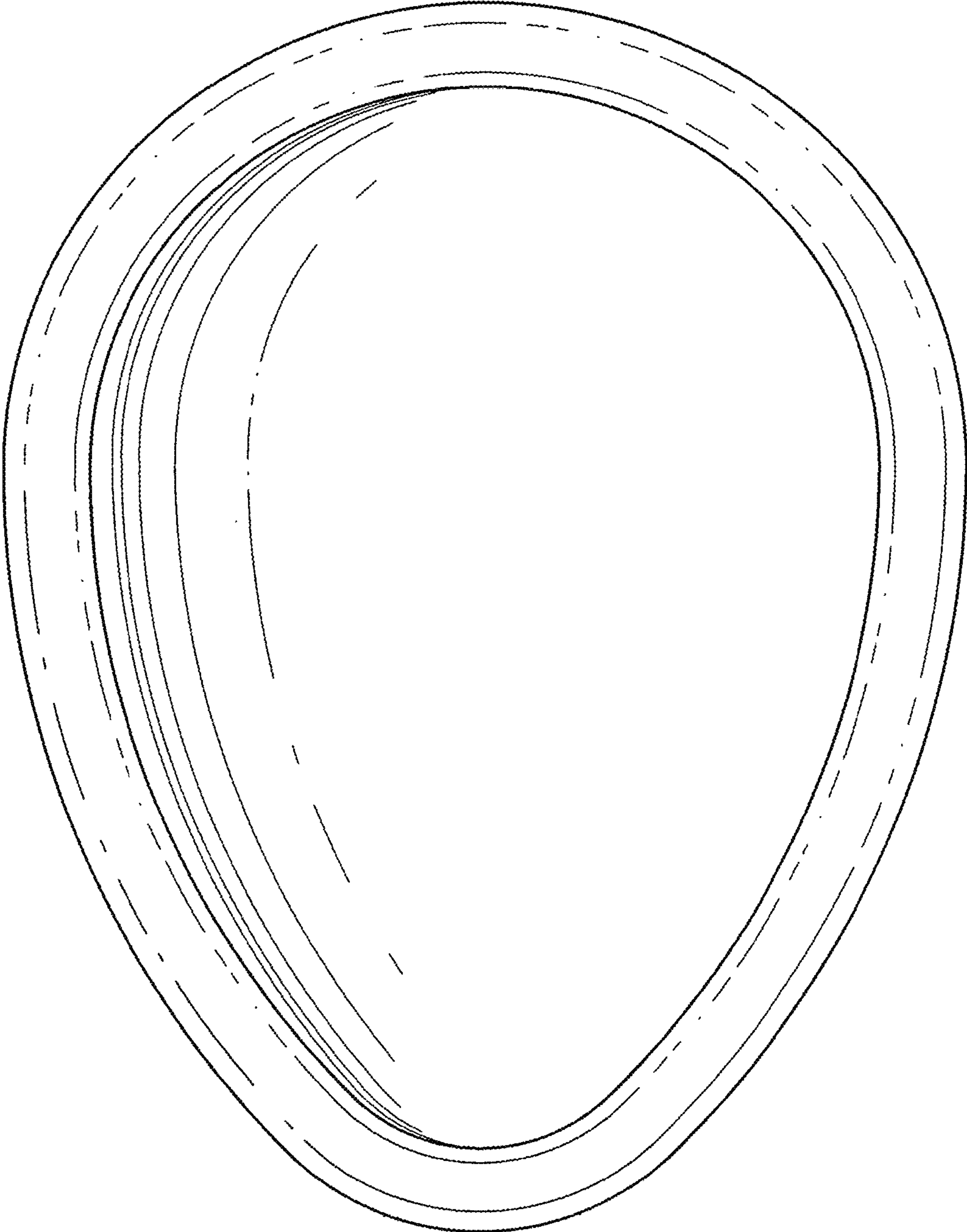

FIG. 17

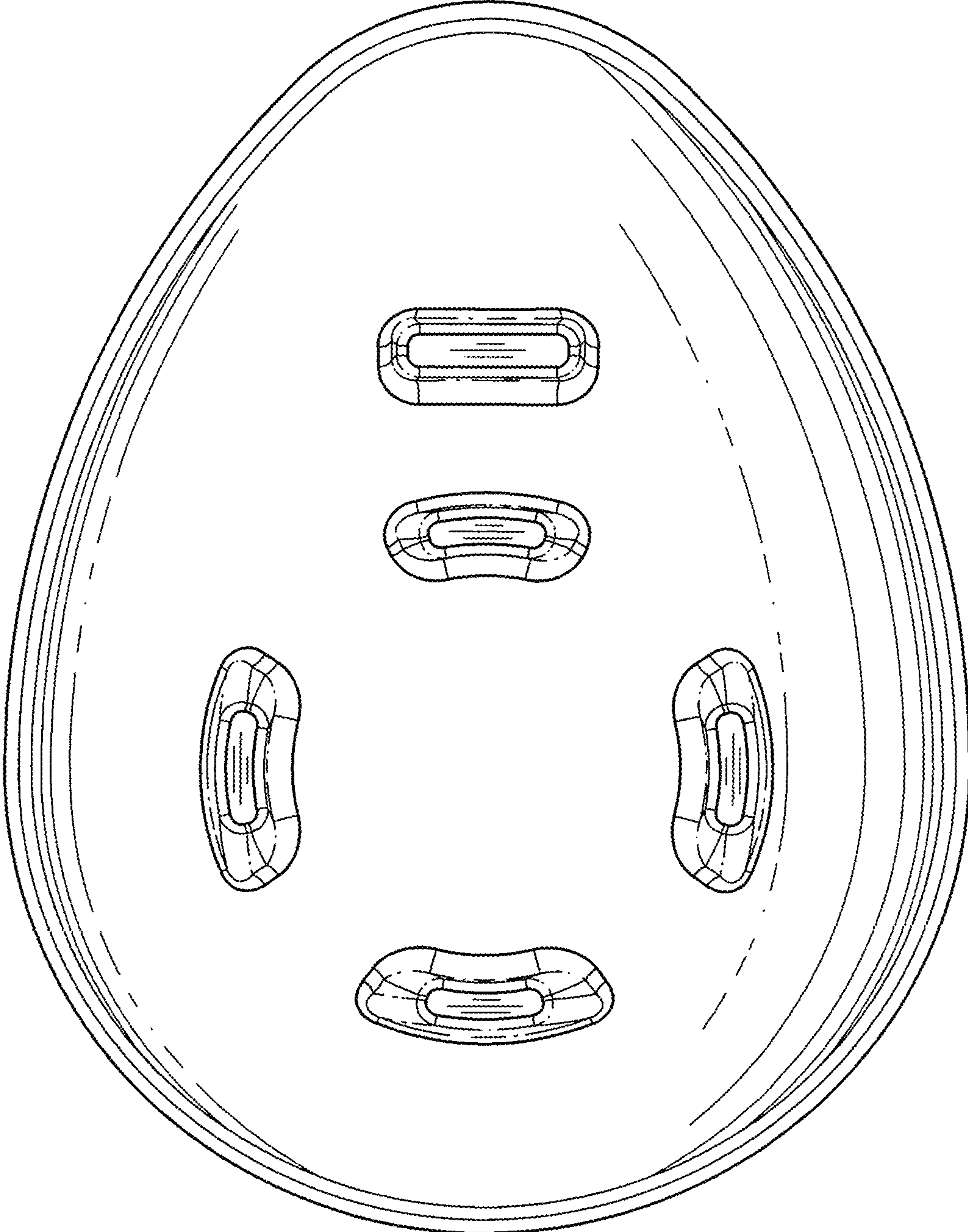

FIG. 18