



US00D777421S

(12) **United States Design Patent**
Grote

(10) **Patent No.:** **US D777,421 S**
(45) **Date of Patent:** **** Jan. 31, 2017**

(54) **WALLET STYLE PORTABLE ELECTRONIC
DEVICE CASE**

(71) Applicant: **Griffin Technology, Inc.**, Nashville, TN
(US)

(72) Inventor: **Paul S. Grote**, Old Hickory, TN (US)

(73) Assignee: **Griffin Technology, Inc.**, Nashville, TN
(US)

(**) Term: **15 Years**

(21) Appl. No.: **29/534,622**

(22) Filed: **Jul. 30, 2015**

(51) **LOC (10) Cl.** **03-01**

(52) **U.S. Cl.**
USPC **D3/218; D14/250**

(58) **Field of Classification Search**
USPC D14/250, 341-347, 130, 138 C, 138 G,
D14/138 R, 138 AA, 147, 203.1, 203.3,
D14/203.7, 204.4; D3/218, 226, 227,
D3/247-251, 900

(Continued)

(56) **References Cited**

U.S. PATENT DOCUMENTS

2,755,837 A * 7/1956 Kosek A45C 3/02
190/901

D582,405 S * 12/2008 Andre D3/299

(Continued)

Primary Examiner — Freda S Nunn

(74) *Attorney, Agent, or Firm* — Hornkohl Intellectual
Property Law, PLLC; Jason L. Hornkohl

(57) **CLAIM**

The ornamental design for a wallet style portable electronic device case, as shown and described.

DESCRIPTION

FIG. 1 is a front perspective view of the new design for a wallet style portable electronic device case with the case in the open position;

FIG. 2 is a back perspective view of the wallet style portable electronic device case with the case in the open position;

FIG. 3 is a front view of the wallet style portable electronic device case with the case in the open position;

FIG. 4 is a top view of the wallet style portable electronic device case with the case in the open position;

FIG. 5 is a bottom view of the wallet style portable electronic device case with the case in the open position;

FIG. 6 is a left side view of the wallet style portable electronic device case with the case in the open position;

FIG. 7 is a right side view of the wallet style portable electronic device case with the case in the open position;

FIG. 8 is a back view of the wallet style portable electronic device case with the case in the open position;

FIG. 9 is a front perspective view of the new design for a wallet style portable electronic device case with the case in the closed position;

FIG. 10 is a back perspective view of the wallet style portable electronic device case with the case in the closed position;

FIG. 11 is a front view of the wallet style portable electronic device case with the case in the closed position;

FIG. 12 is a top view of the wallet style portable electronic device case with the case in the closed position;

FIG. 13 is a bottom view of the wallet style portable electronic device case with the case in the closed position;

FIG. 14 is a left side view of the wallet style portable electronic device case with the case in the closed position;

FIG. 15 is a right side view of the wallet style portable electronic device case with the case in the closed position;

and,

FIG. 16 is a back view of the wallet style portable electronic device case with the case in the closed position.

Broken lines shown in the drawings represent environment only and form no part of the claimed design.

1 Claim, 8 Drawing Sheets

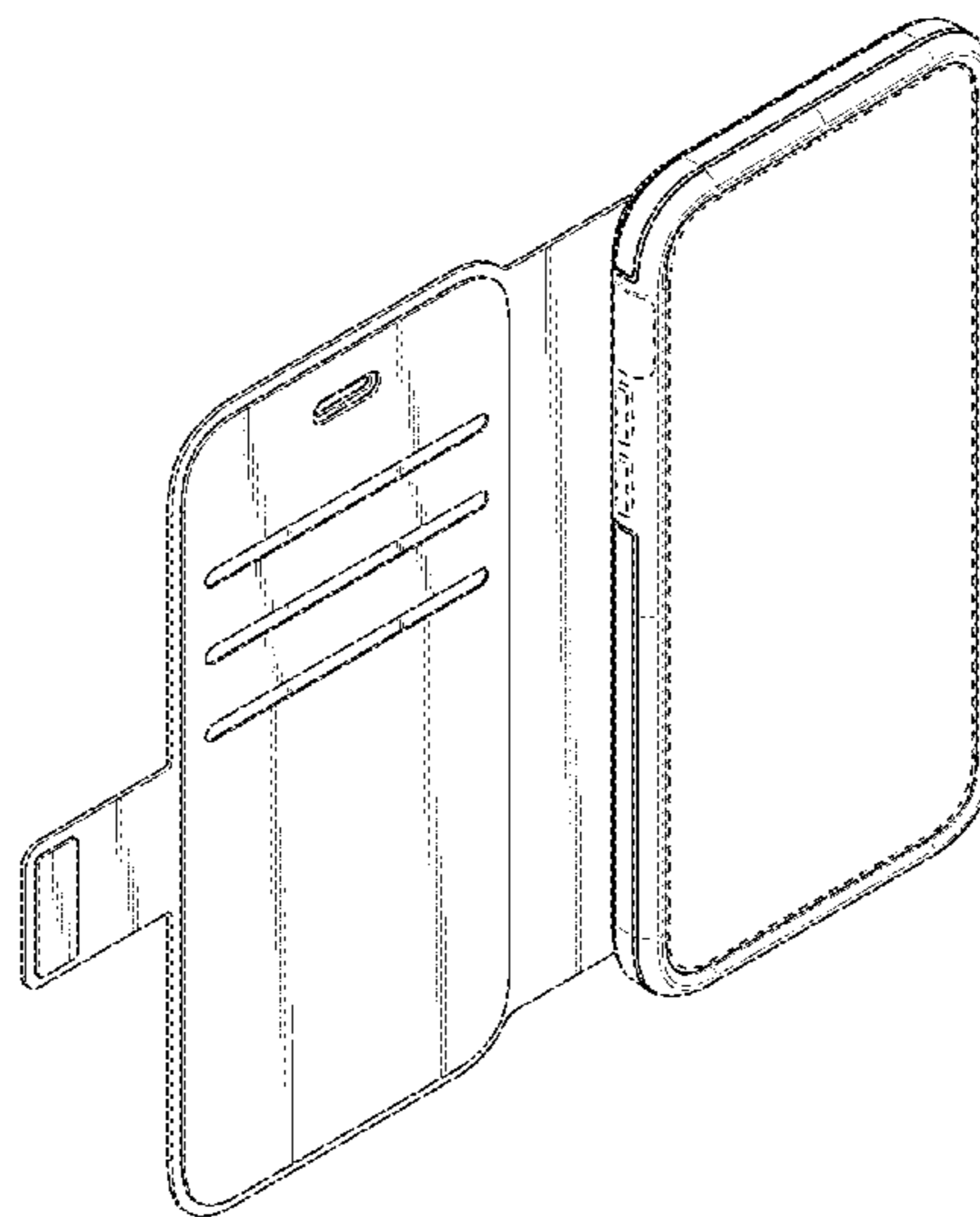

(58) **Field of Classification Search**

CPC A45C 1/06; A45C 11/00; A45C 2011/002;
A45C 3/02; A45F 2200/0525; A45F
2200/0516; A45F 5/02; G06F
1/165; G06F 1/1613; G06F 1/1624; G06F
1/1626; G06F 3/0485; G06F
3/0488; G06F 1/1632; G06F
1/1607; G06F 1/1628; G06F
1/1656; H04B 1/3888; H04B 1/00; H04B
1/3883; H04M 1/0202; H04M
1/0283; H04M 1/185; H04M 1/00; H04M
1/0214; H04M 1/035; H04M 1/04; H01M
10/46; H01M 2/1022; H05K
5/0217; H05K 5/03; H05K 7/00; H05K
5/0086; B29C 45/1676; H02J 7/00; H04Q
7/32; B65D 85/00; B65D 19/00; G03B
17/02

See application file for complete search history.

(56) **References Cited**

U.S. PATENT DOCUMENTS

D624,304 S *	9/2010	Danze	D3/201
D705,534 S *	5/2014	Manjerico	D3/218
D710,838 S *	8/2014	Song	D14/250
D716,286 S *	10/2014	Ahn	D14/250
D723,038 S *	2/2015	Kim	D14/440
2011/0290687 A1 *	12/2011	Han	A45C 3/02 206/320
2015/0155903 A1 *	6/2015	Jang	H04B 1/3888 455/575.8

* cited by examiner

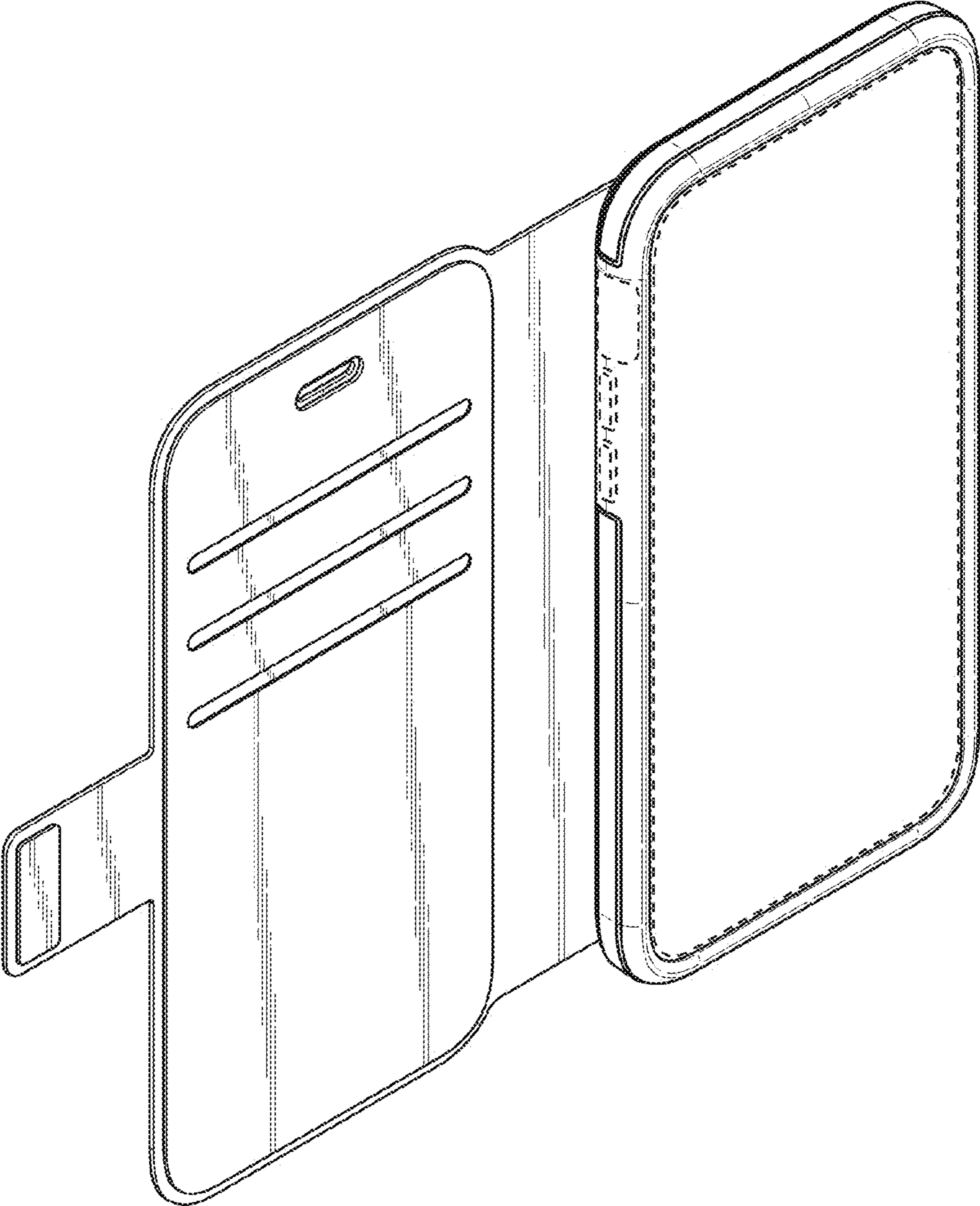

FIG. 1

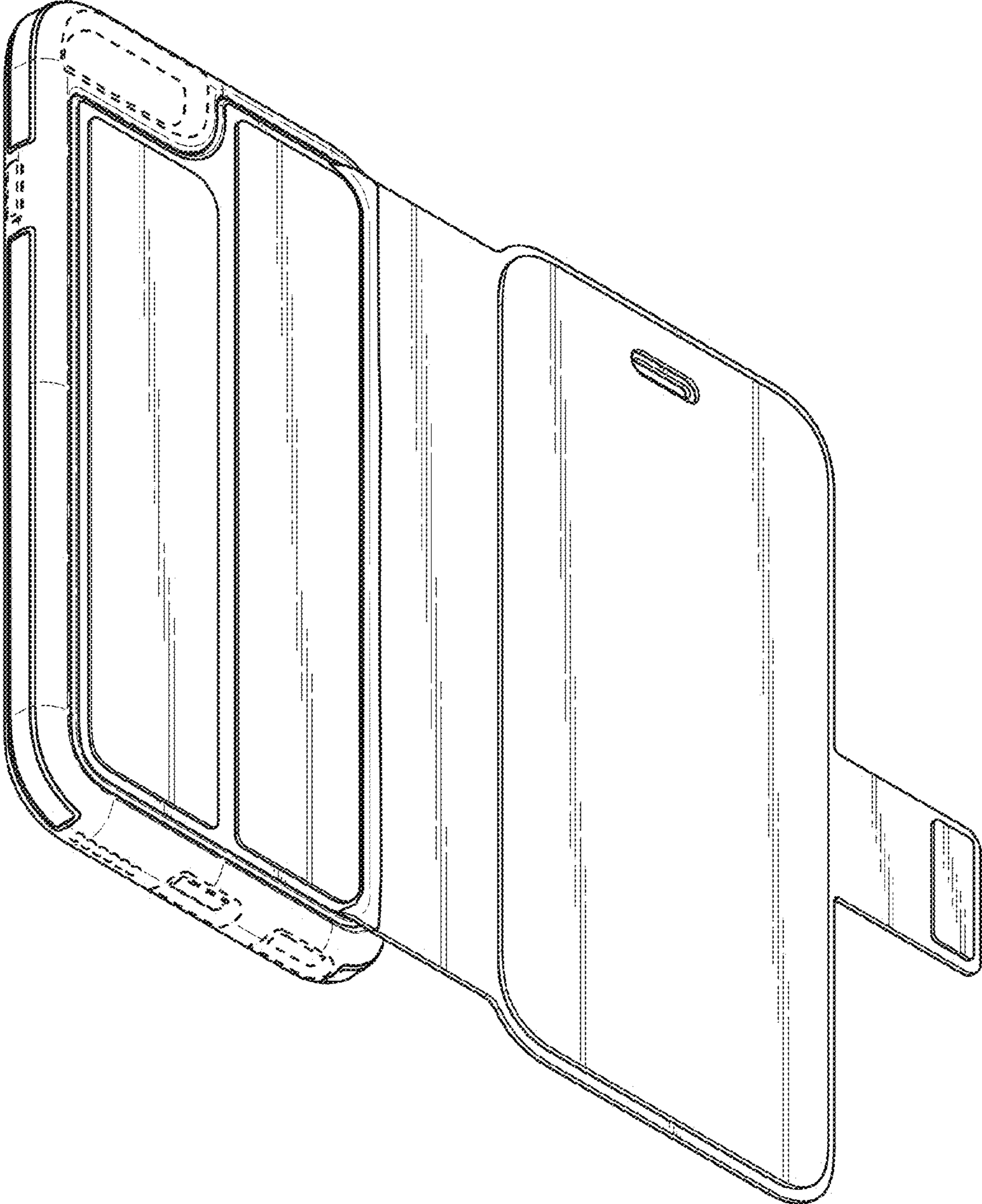

FIG. 2

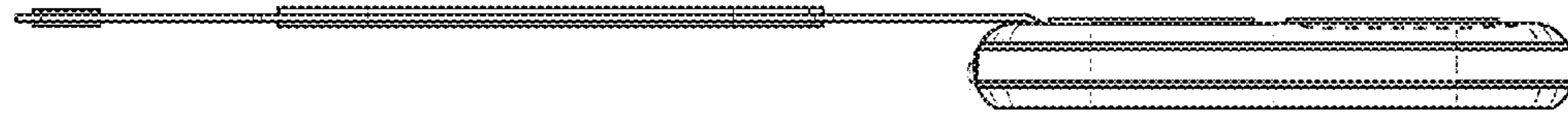

FIG. 4

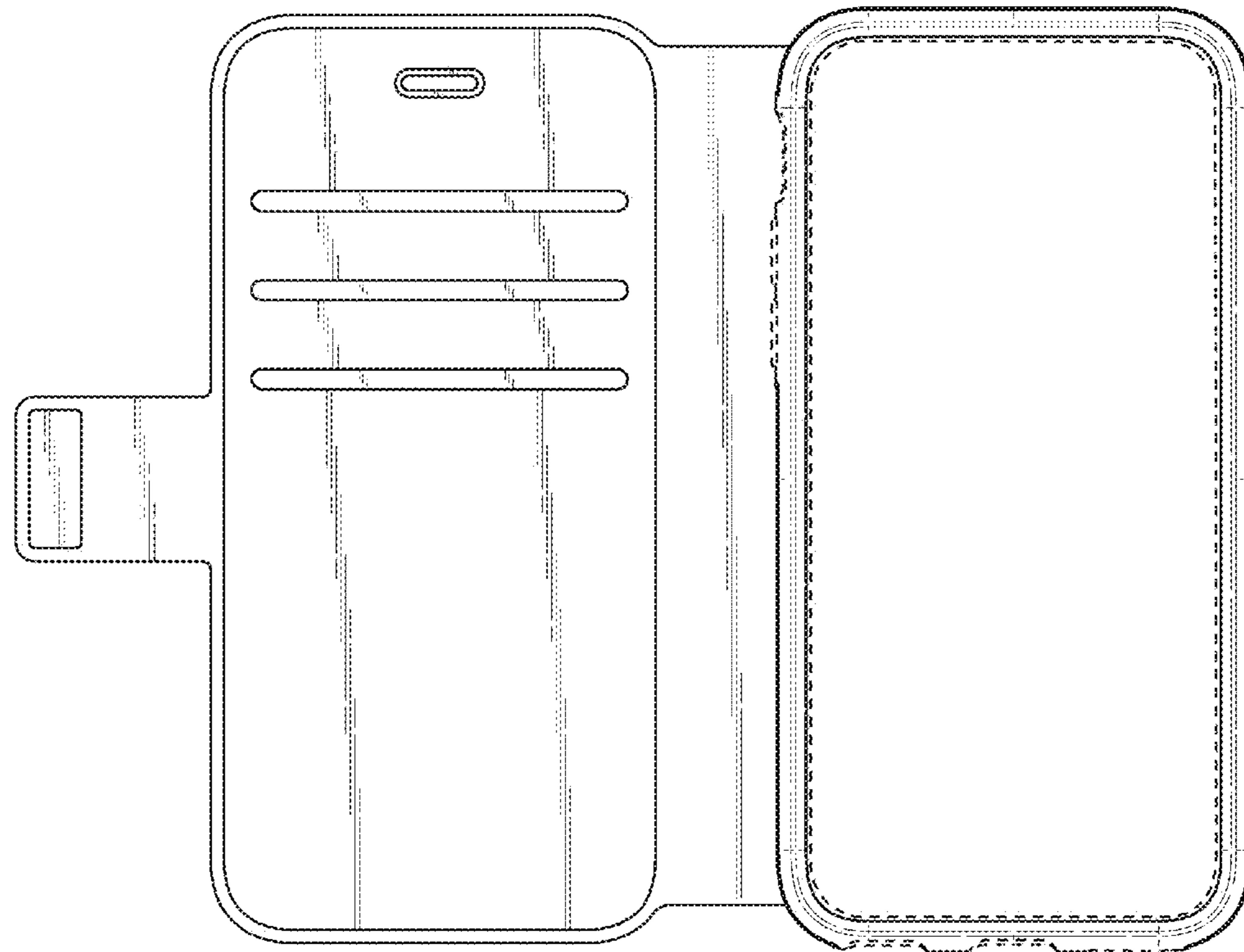

FIG. 3



FIG. 5

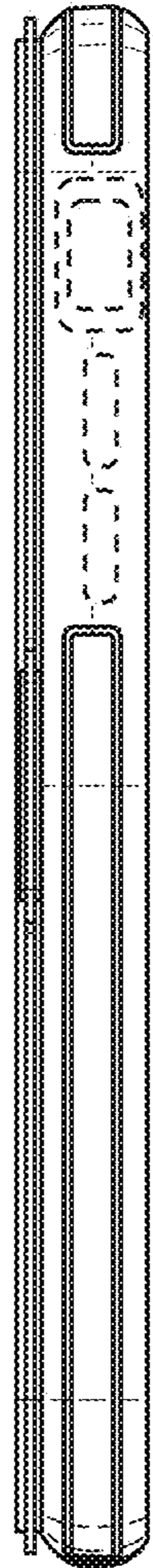

FIG. 6

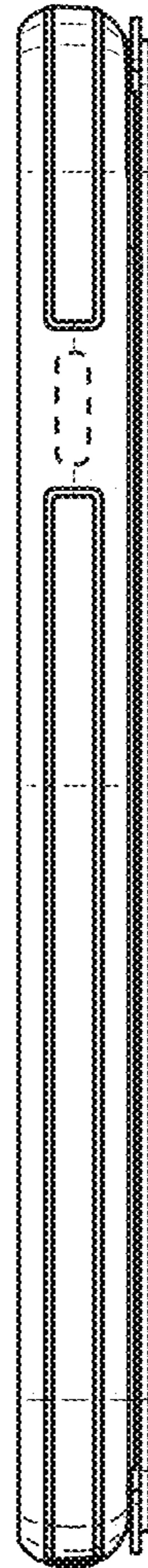

FIG. 7

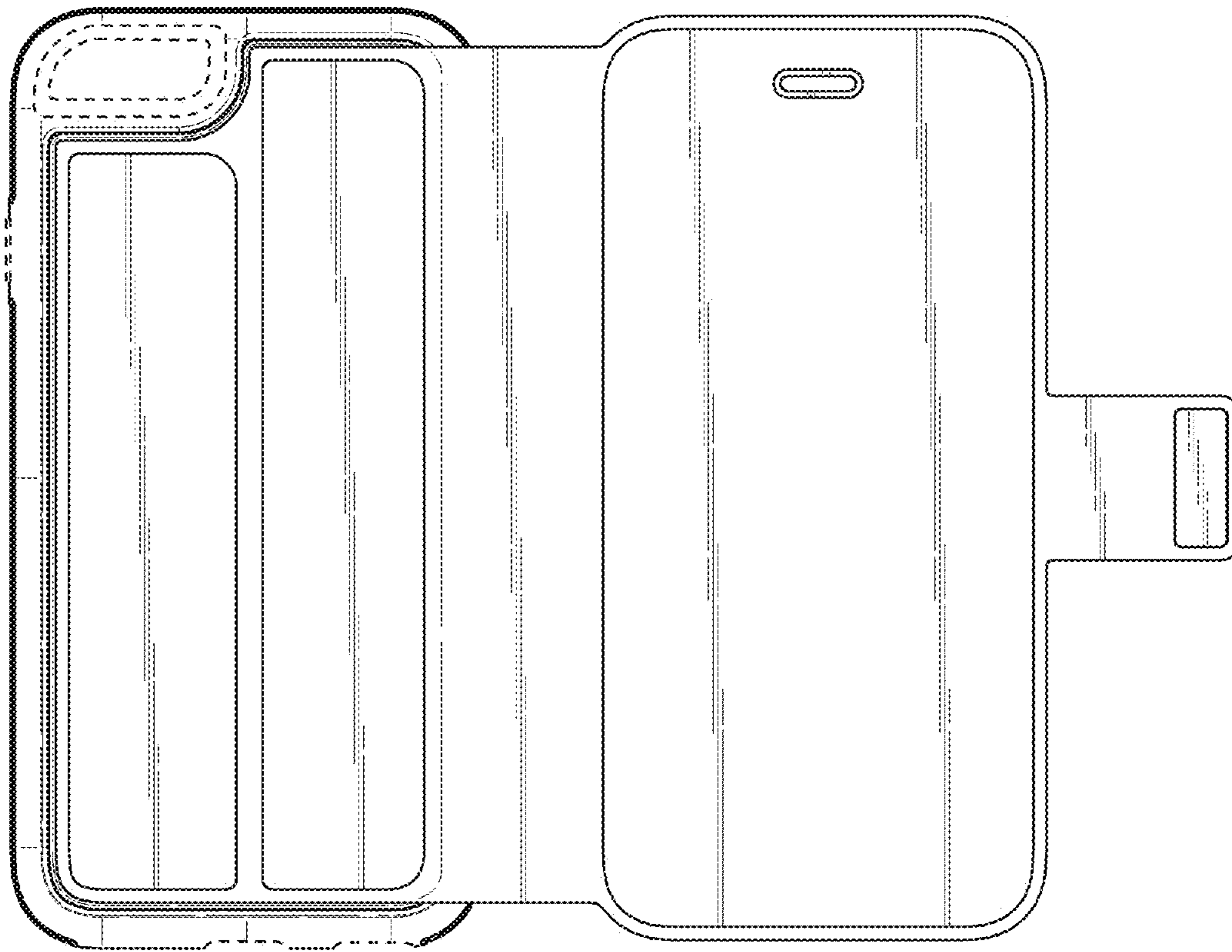

FIG. 8

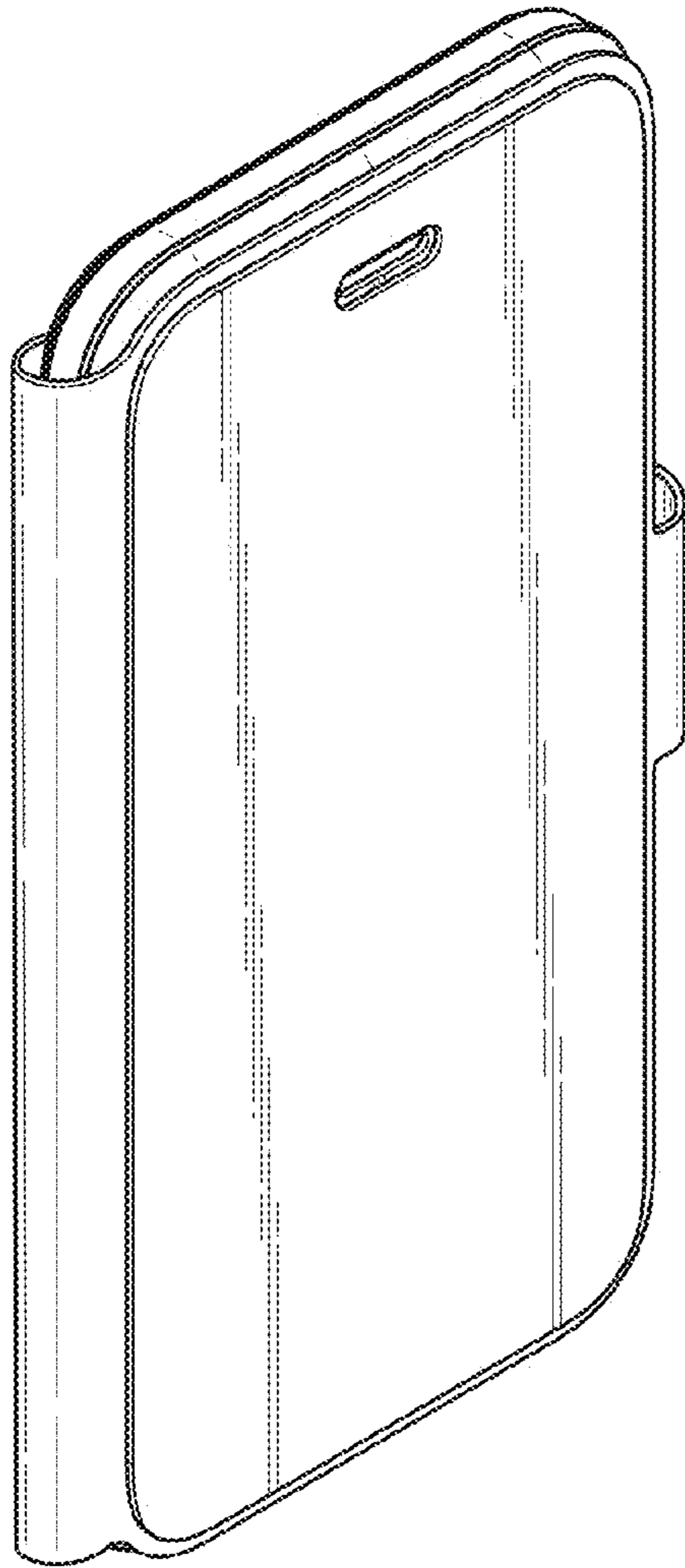

FIG. 9

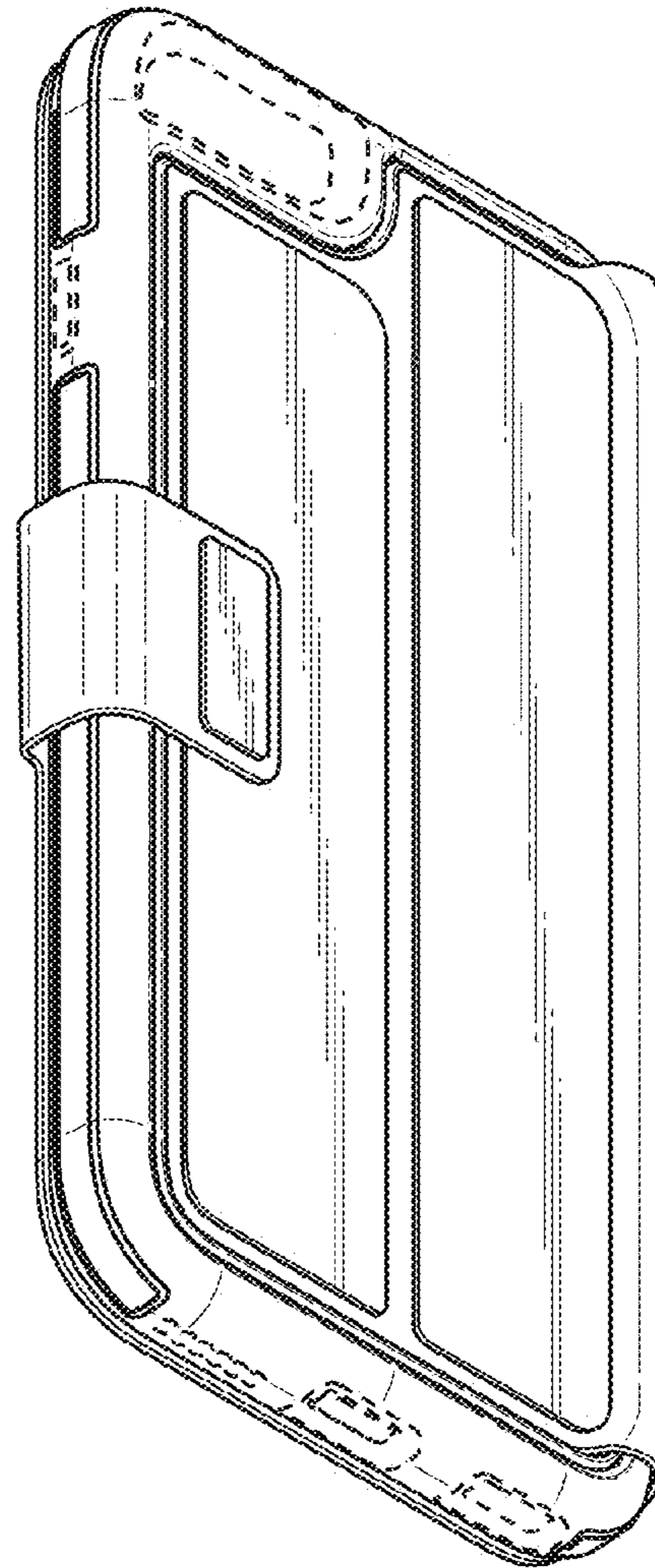

FIG. 10

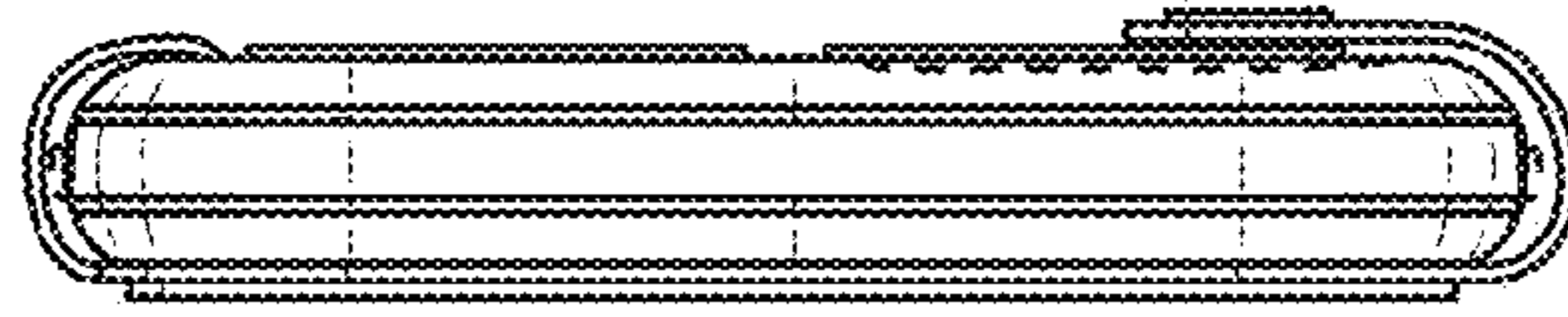

FIG. 12

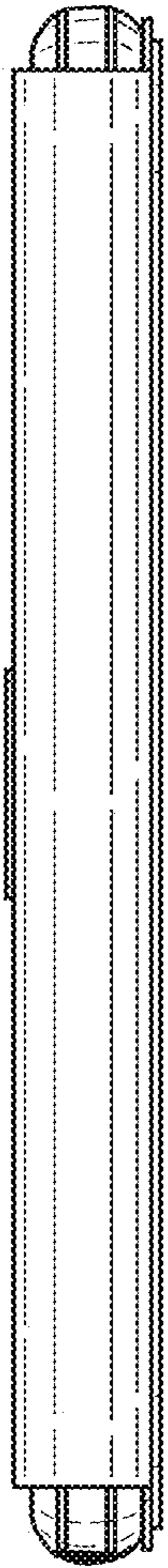

FIG. 14

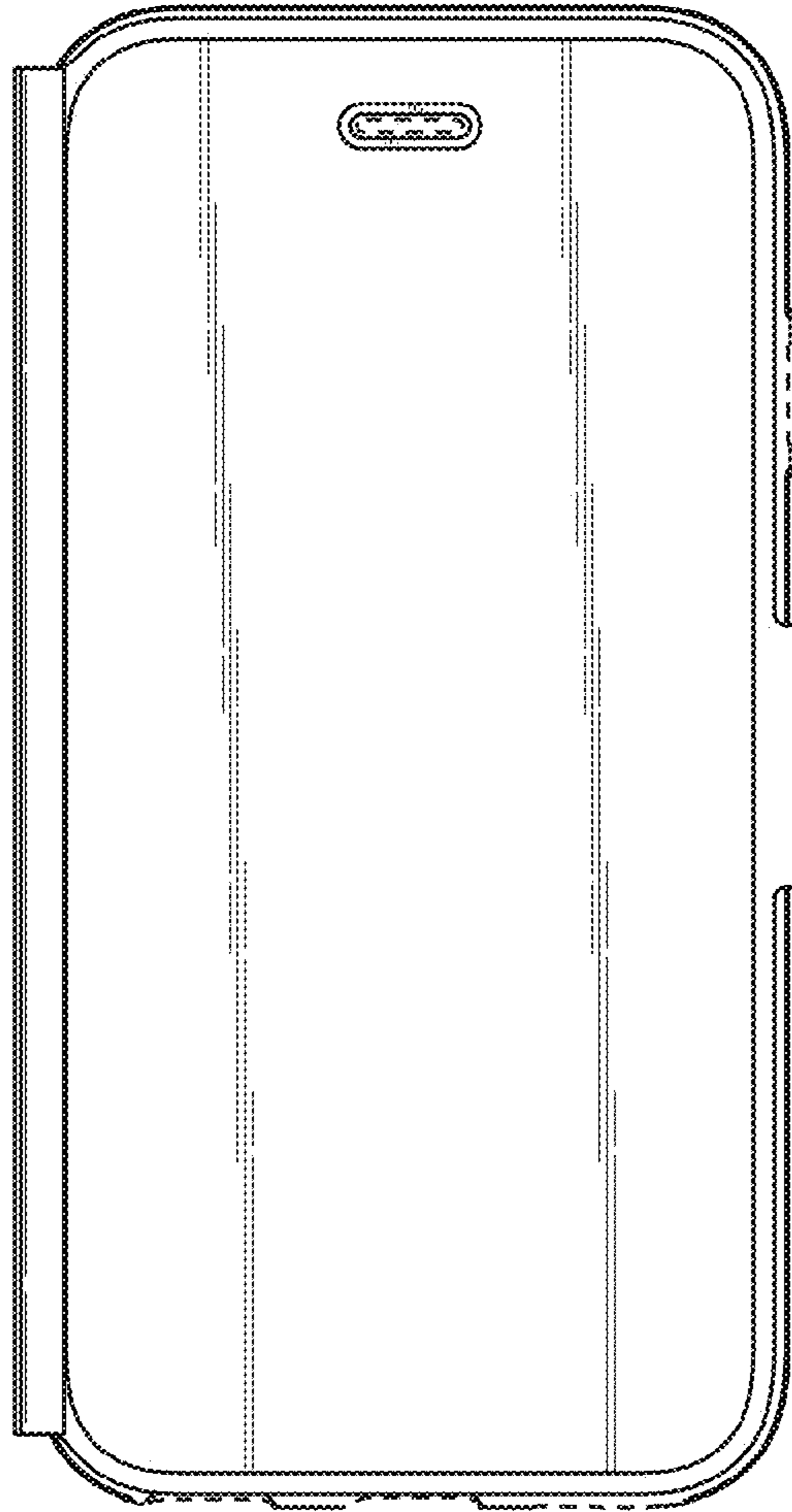

FIG. 11

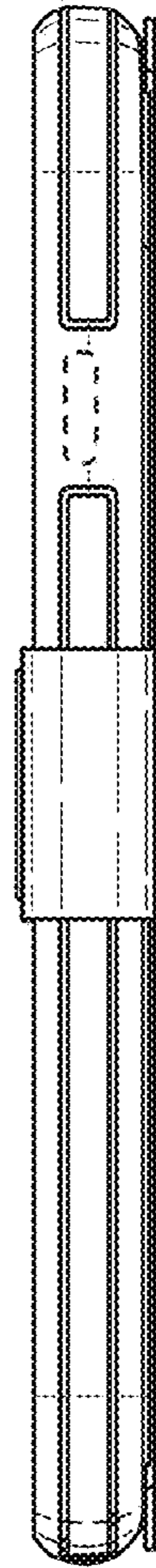

FIG. 15



FIG. 13

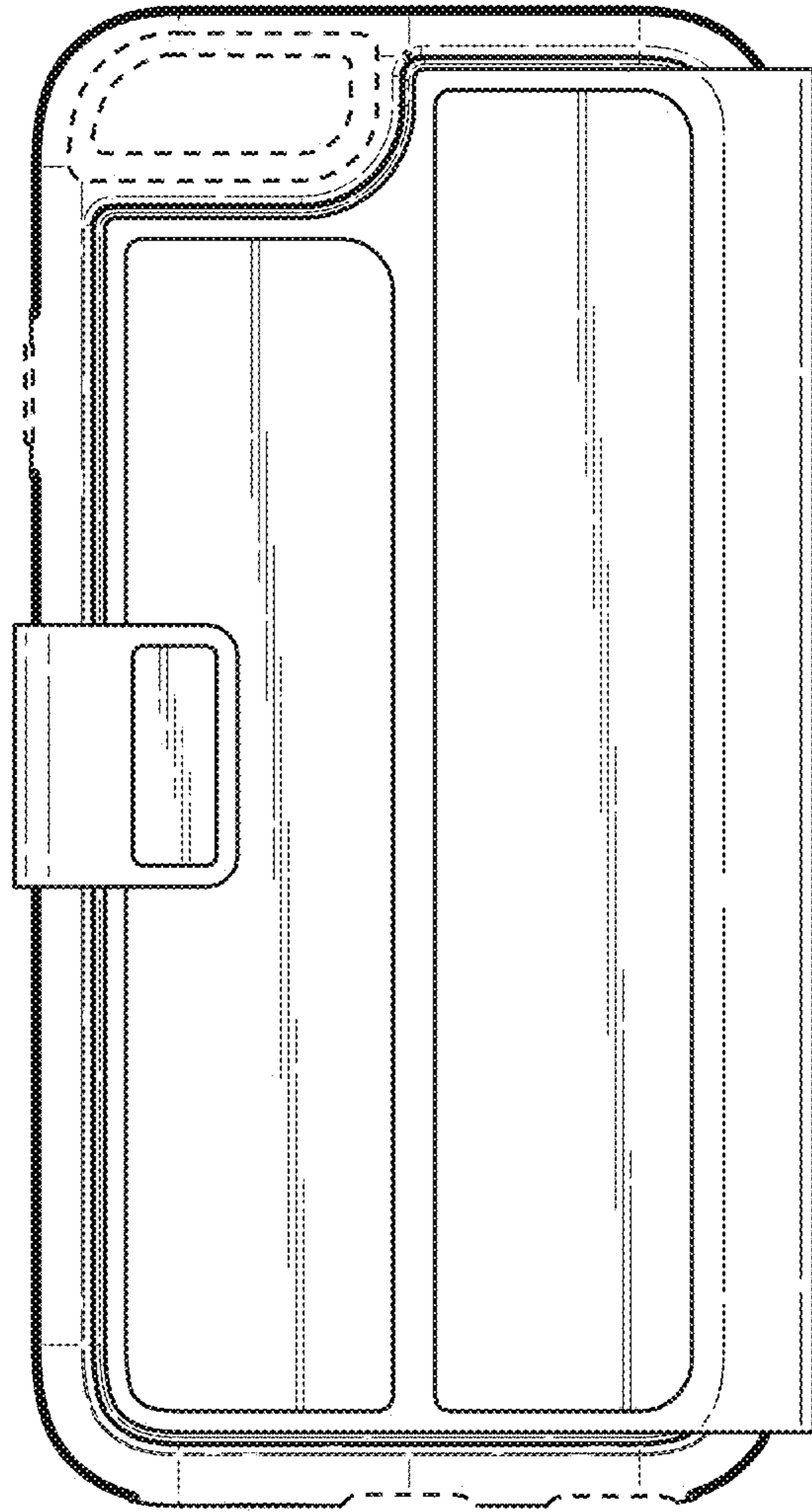

FIG. 16