



US00D777378S

(12) **United States Design Patent**  
**Tien**

(10) **Patent No.:** **US D777,378 S**

(45) **Date of Patent:** **\*\* Jan. 24, 2017**

- (54) **PLATE CARRIER**
- (71) Applicant: **Spencer Tien**, Irwindale, CA (US)
- (72) Inventor: **Spencer Tien**, Irwindale, CA (US)
- (\*\*) Term: **15 Years**
- (21) Appl. No.: **29/551,889**
- (22) Filed: **Jan. 18, 2016**
- (51) **LOC (10) Cl.** ..... **29-02**
- (52) **U.S. Cl.**  
USPC ..... **D29/101.4**
- (58) **Field of Classification Search**  
USPC ... D29/100, 101.1–101.4, 122, 124; D2/626,  
D2/628, 629; D3/215, 218, 219, 221,  
D3/226, 322, 327; D24/190; 359/362,  
359/519; 182/3, 4, 5, 6, 9, 133; 2/300,  
2/310, 311; D10/111; 224/259, 576, 603,  
224/606, 623, 627, 647; D21/683;  
D30/152; 119/770; 297/485  
CPC ..... A45F 5/00  
See application file for complete search history.

- 7,424,748 B1 \* 9/2008 McDunn ..... F41H 5/013  
2/102
- 7,490,358 B1 \* 2/2009 Beck ..... A41D 13/0531  
2/102
- 7,526,842 B2 \* 5/2009 Wemmer ..... A41D 27/20  
24/3.7
- D611,681 S \* 3/2010 Pettingill ..... D2/839
- D631,611 S \* 1/2011 Sattler ..... D29/101.4
- 9,173,473 B2 \* 11/2015 Gleason ..... A45F 3/047

\* cited by examiner

*Primary Examiner* — Randall Gholson

(74) *Attorney, Agent, or Firm* — Clement Cheng

(57) **CLAIM**

The ornamental design for a plate carrier, as shown and described.

**DESCRIPTION**

FIG. 1 is a perspective view.

FIG. 2 is a front view.

FIG. 3 is a rear view.

FIG. 4 is a left side view.

FIG. 5 is a right side view.

FIG. 6 is a top view; and,

FIG. 7 is a bottom view.

The broken lines shown in the drawings show unclaimed subject matter only and form no part of the claimed design.

(56) **References Cited**

**U.S. PATENT DOCUMENTS**

- D402,788 S \* 12/1998 Blankenship, Jr. .... D2/829
- 6,185,738 B1 \* 2/2001 Sidebottom ..... F41H 1/02  
2/102

**1 Claim, 6 Drawing Sheets**

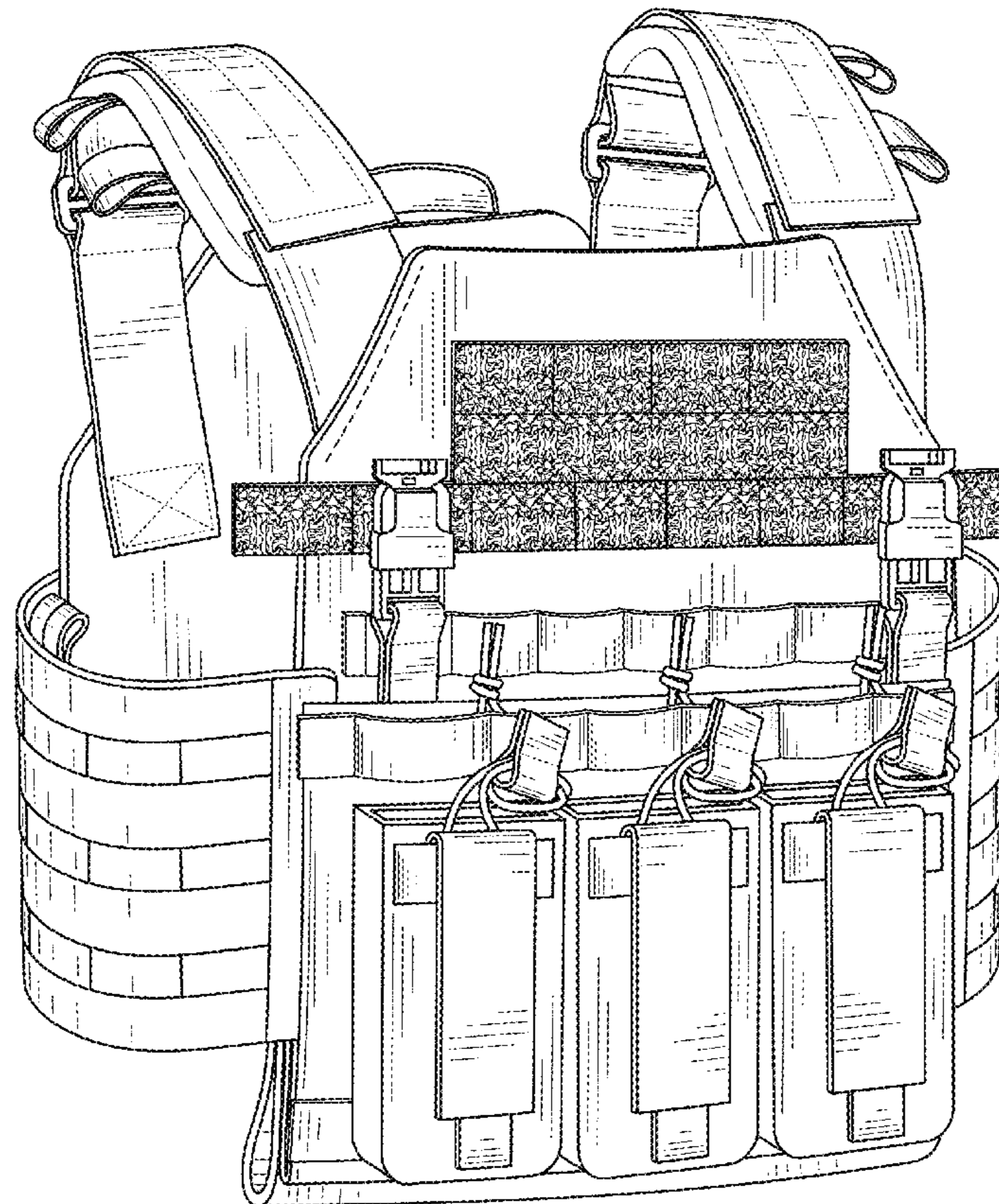

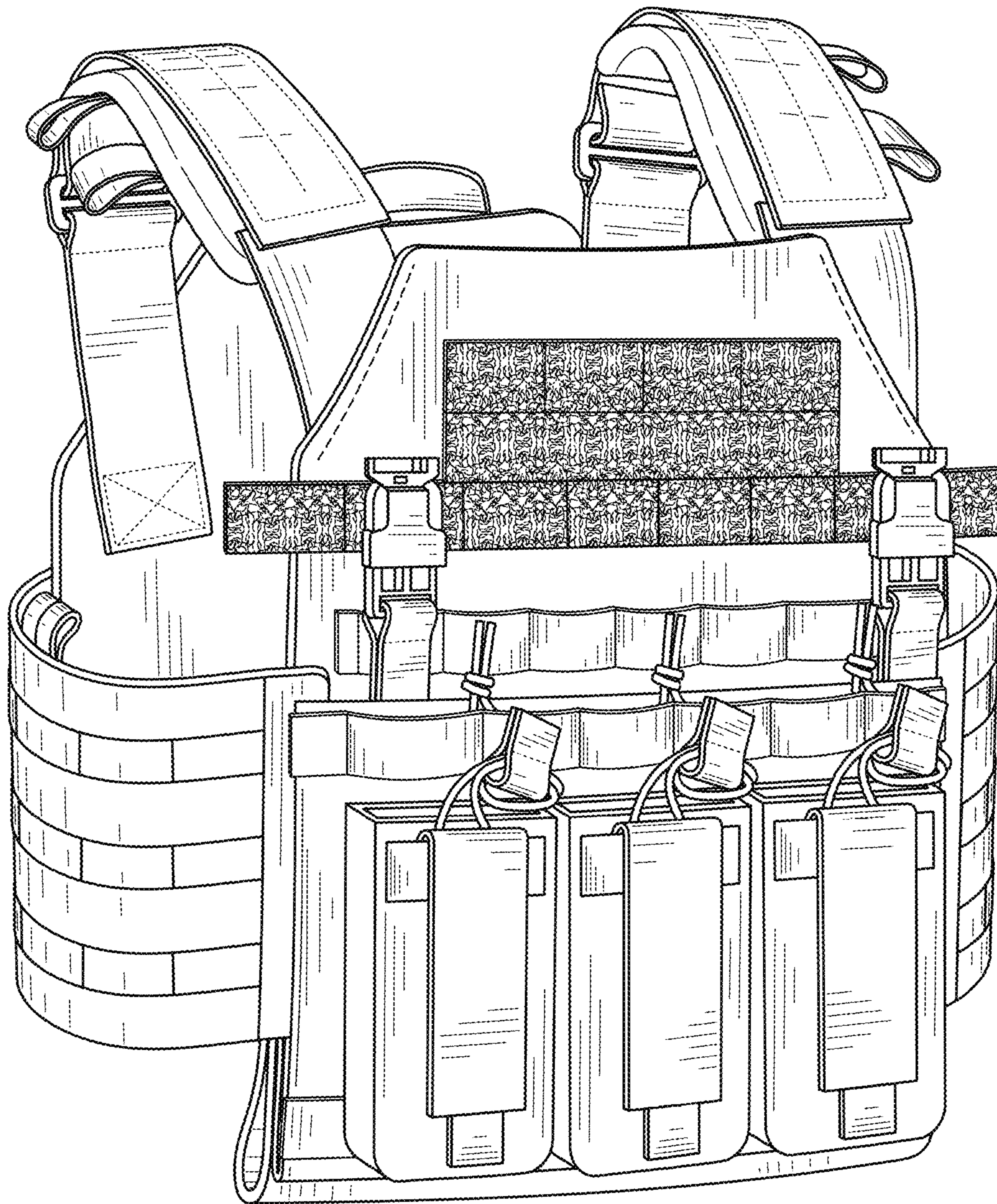

FIG. 1

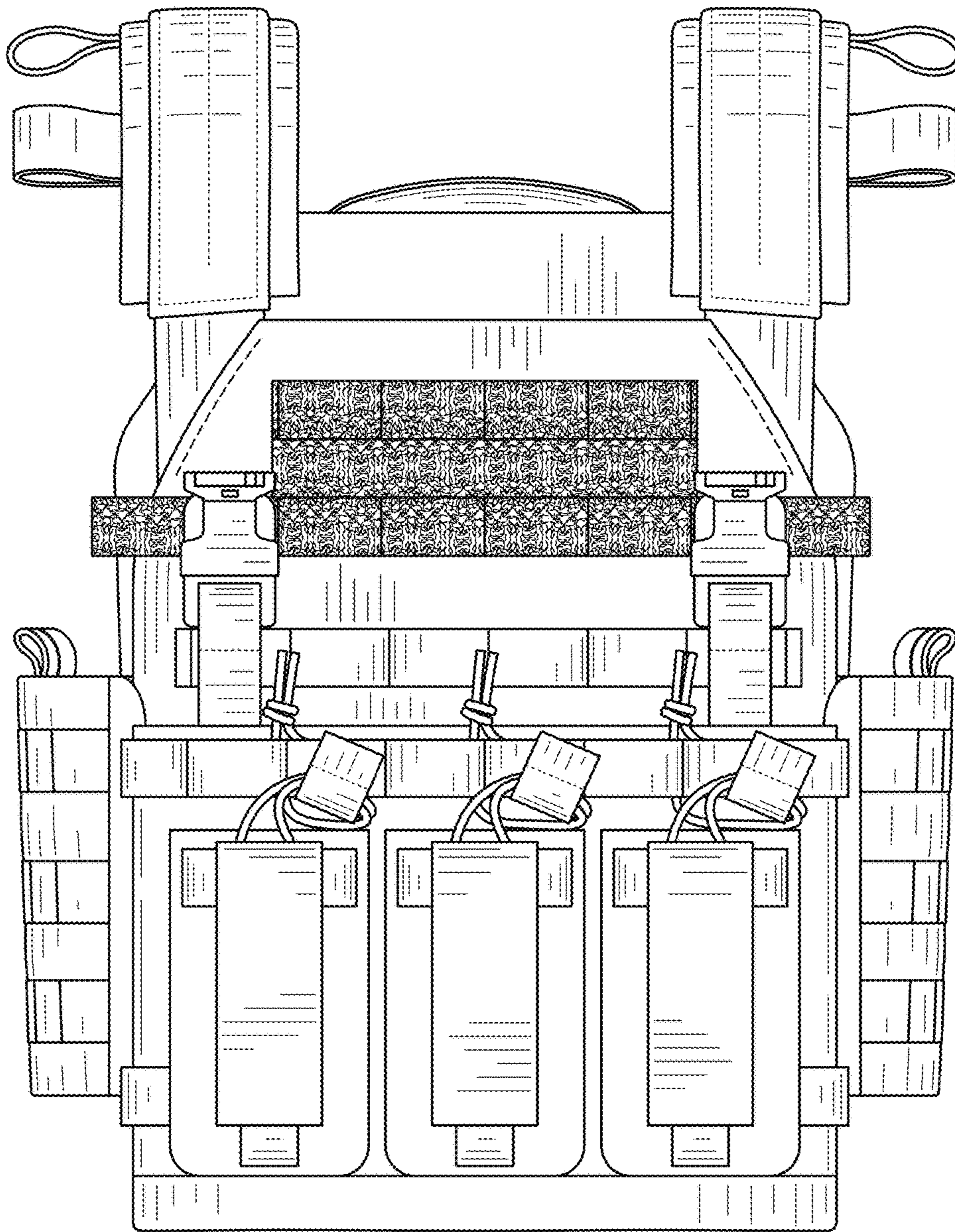

FIG. 2

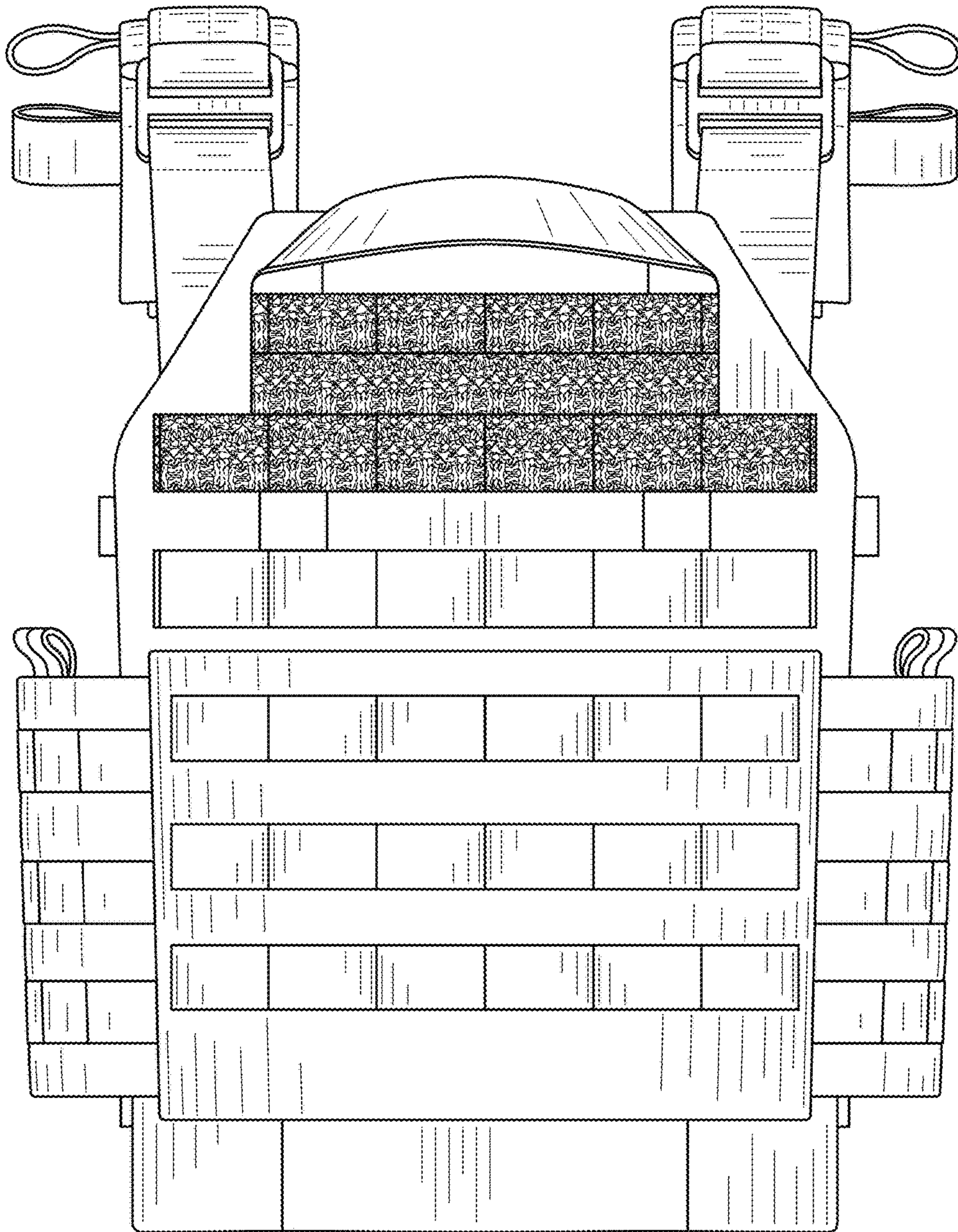

FIG. 3

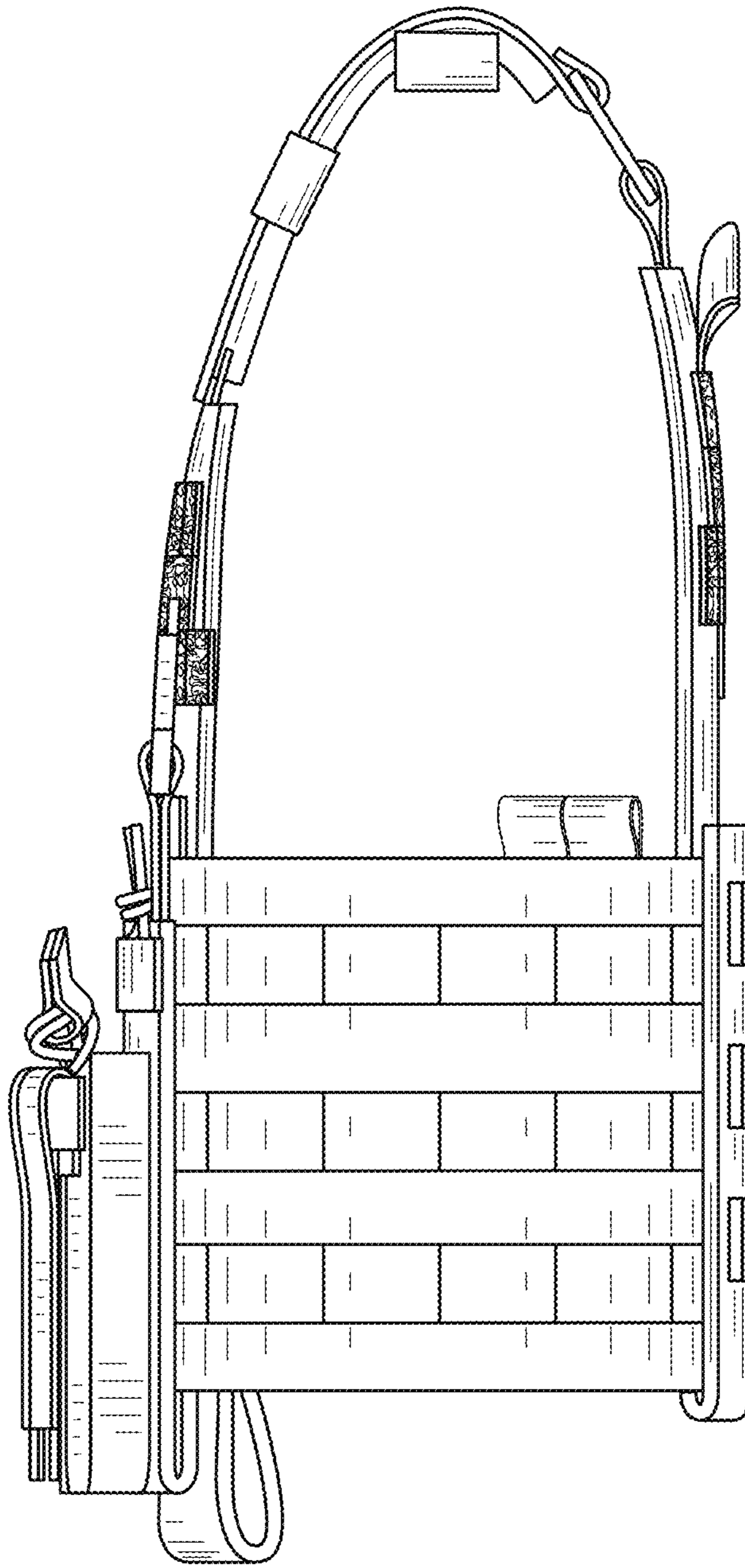

FIG. 4

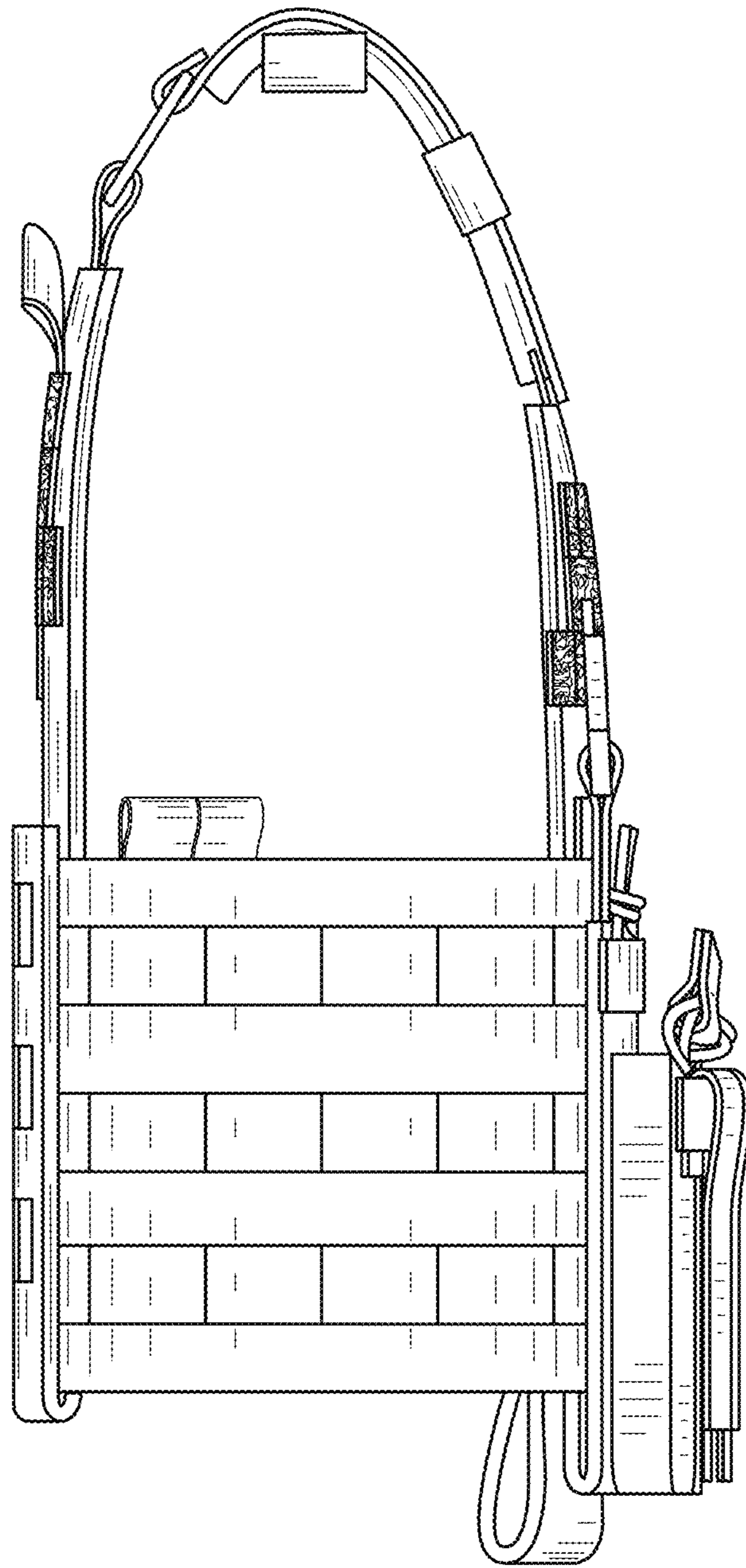

FIG. 5

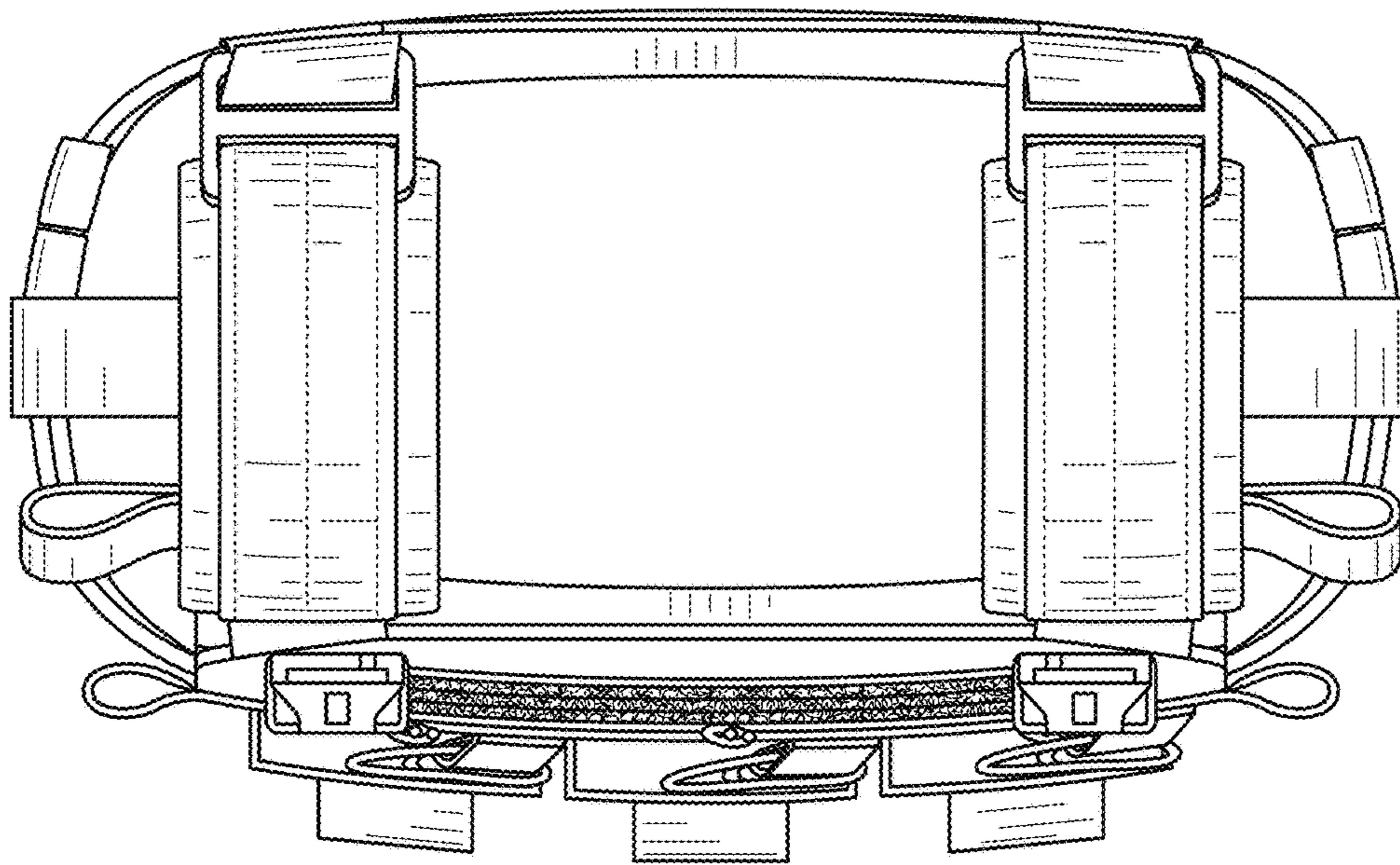

FIG. 6

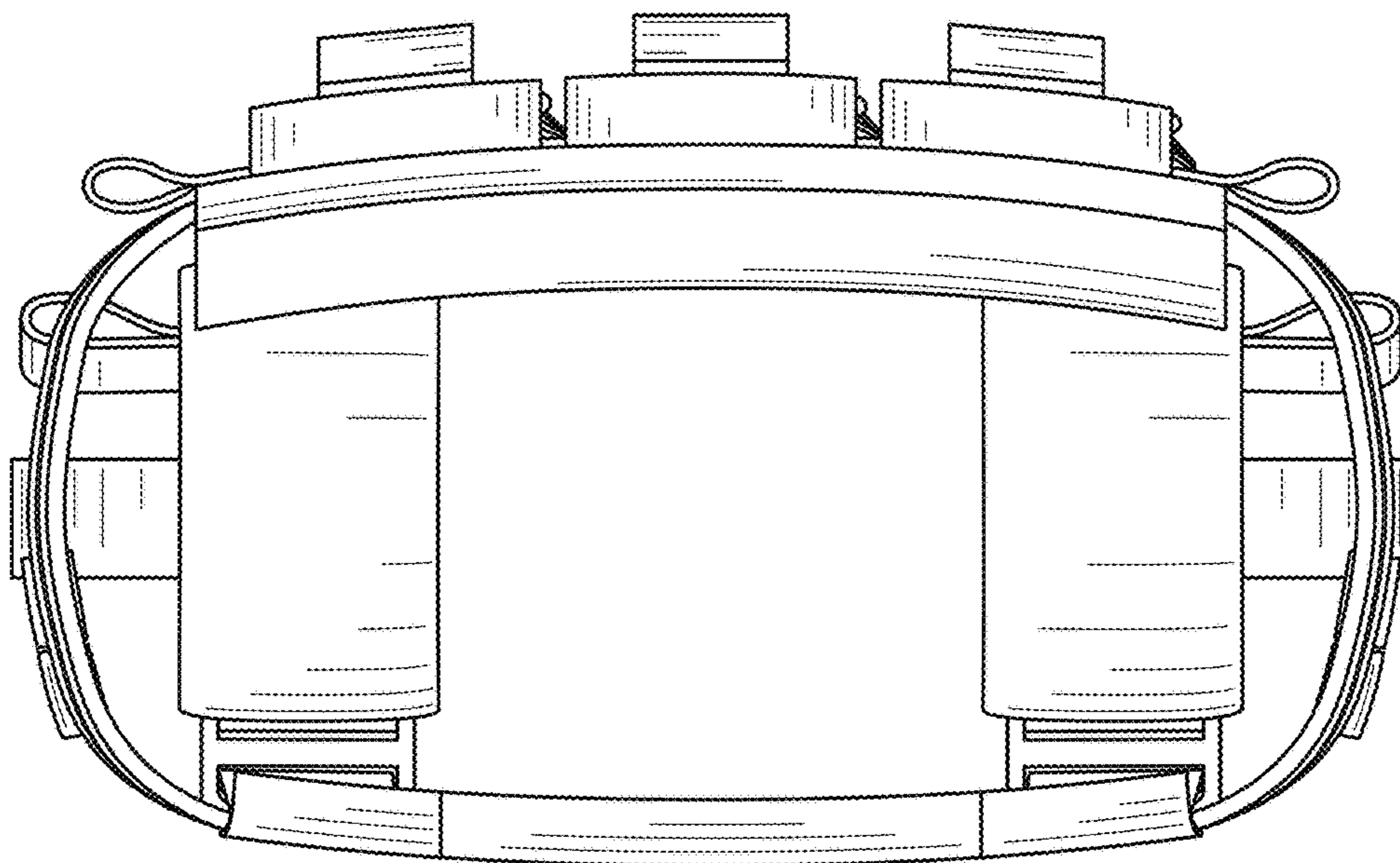

FIG. 7