



US00D777158S

(12) **United States Design Patent**
Lee et al.

(10) **Patent No.:** **US D777,158 S**
(45) **Date of Patent:** **** Jan. 24, 2017**

- (54) **COVER FOR AN ELECTRONIC COMMUNICATIONS DEVICE**
- (71) Applicant: **Samsung Electronics Co., Ltd.**, Suwon-si (KR)
- (72) Inventors: **Ji Young Lee**, Seoul (KR); **Hyok Su Choi**, Seoul (KR); **Young Wha Oh**, Seoul (KR); **Hye Jin Bang**, Seongnam-si (KR)
- (73) Assignee: **SAMSUNG ELECTRONICS CO., LTD.**, Suwon-si (KR)

D657,354 S *	4/2012	Kim	D14/250
D674,799 S *	1/2013	Kim	D14/440
D685,799 S *	7/2013	Canizares	D14/440
D685,800 S *	7/2013	Canizares	D14/440
D685,801 S *	7/2013	Canizares	D14/440
D685,802 S *	7/2013	Canizares	D14/440
D694,741 S *	12/2013	Kim	D14/250
D702,673 S *	4/2014	Murchison	D14/250
D704,691 S *	5/2014	Kim	D14/250
D705,207 S *	5/2014	Kim	D14/250
D705,783 S *	5/2014	Weng	D14/440
D707,218 S *	6/2014	YoonYoung	D14/250
D710,838 S *	8/2014	Song	D14/250

(Continued)

(**) Term: **14 Years**

Primary Examiner — Carla Jobe Wright

(21) Appl. No.: **29/522,152**

(74) *Attorney, Agent, or Firm* — McAndrews Held & Malloy, Ltd.

(22) Filed: **Mar. 27, 2015**

(57) **CLAIM**

(30) **Foreign Application Priority Data**

The ornamental design for a cover for an electronic communications device, as shown and described.

Feb. 16, 2015 (KR) 30-2015-0008455

(51) **LOC (10) Cl.** **14-03**

DESCRIPTION

(52) **U.S. Cl.**
USPC **D14/250**

(58) **Field of Classification Search**
USPC D14/238.1, 440, 203.3–203.7, 217, 240, D14/248, 251–253, 447, 496, 250; D3/201, 218, 247, 269, 273, 301, 303; D13/103, 107–108, 119
CPC ... H04B 1/3888; A45C 1/06; A45C 2011/002; A45C 11/00; A45C 13/02; H04M 1/0202; H04M 1/0283; A45F 2200/0516; A45F 2005/026; A45F 2200/0525
See application file for complete search history.

FIG. 1 is a top left front perspective view of a cover for an electronic communications device showing our new design; FIG. 2 is a front view thereof; FIG. 3 is a rear view thereof; FIG. 4 is a left-side elevation view thereof; FIG. 5 is a right-side elevation view thereof; FIG. 6 is a top plan view thereof; FIG. 7 is a bottom plan view thereof; and, FIG. 8 is a top left front perspective view thereof, showing the cover for an electronic communications device in an open position.

(56) **References Cited**

The broken lines in the drawing figures depict portions of the cover for an electronic communications device that form no part of the claimed design. The broken lines and unshaded areas bounded by broken lines form no part of the claimed design.

U.S. PATENT DOCUMENTS

D641,348 S *	7/2011	Kim	D14/250
D652,829 S *	1/2012	Kim	D14/250

1 Claim, 6 Drawing Sheets

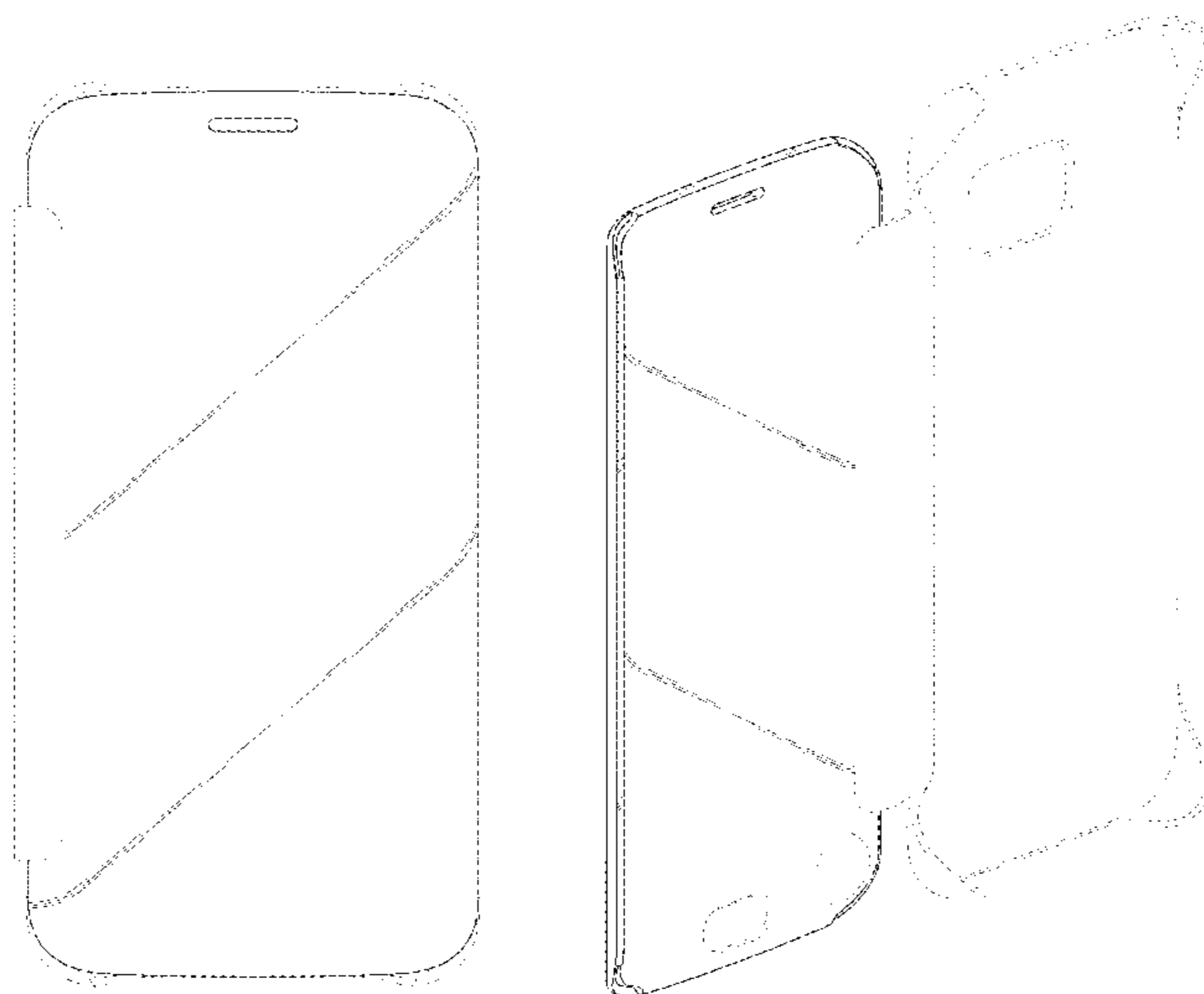

(56)

References Cited

U.S. PATENT DOCUMENTS

D711,861 S *	8/2014	Mei	D14/250
D712,393 S *	9/2014	Kim	D14/250
D714,053 S *	9/2014	Yoo	D3/269
D714,280 S *	9/2014	Ahn	D14/250
D714,550 S *	10/2014	Yoo	D3/269
D716,286 S *	10/2014	Ahn	D14/250
D723,020 S *	2/2015	Kim	D14/250
D728,552 S *	5/2015	Kim	D14/250
D762,630 S *	8/2016	Shin	D14/250
2012/0085679 A1 *	4/2012	Kim	A45C 3/001 206/736
2015/0024812 A1 *	1/2015	Xie	H04B 1/3888 455/575.8

* cited by examiner

FIG. 1

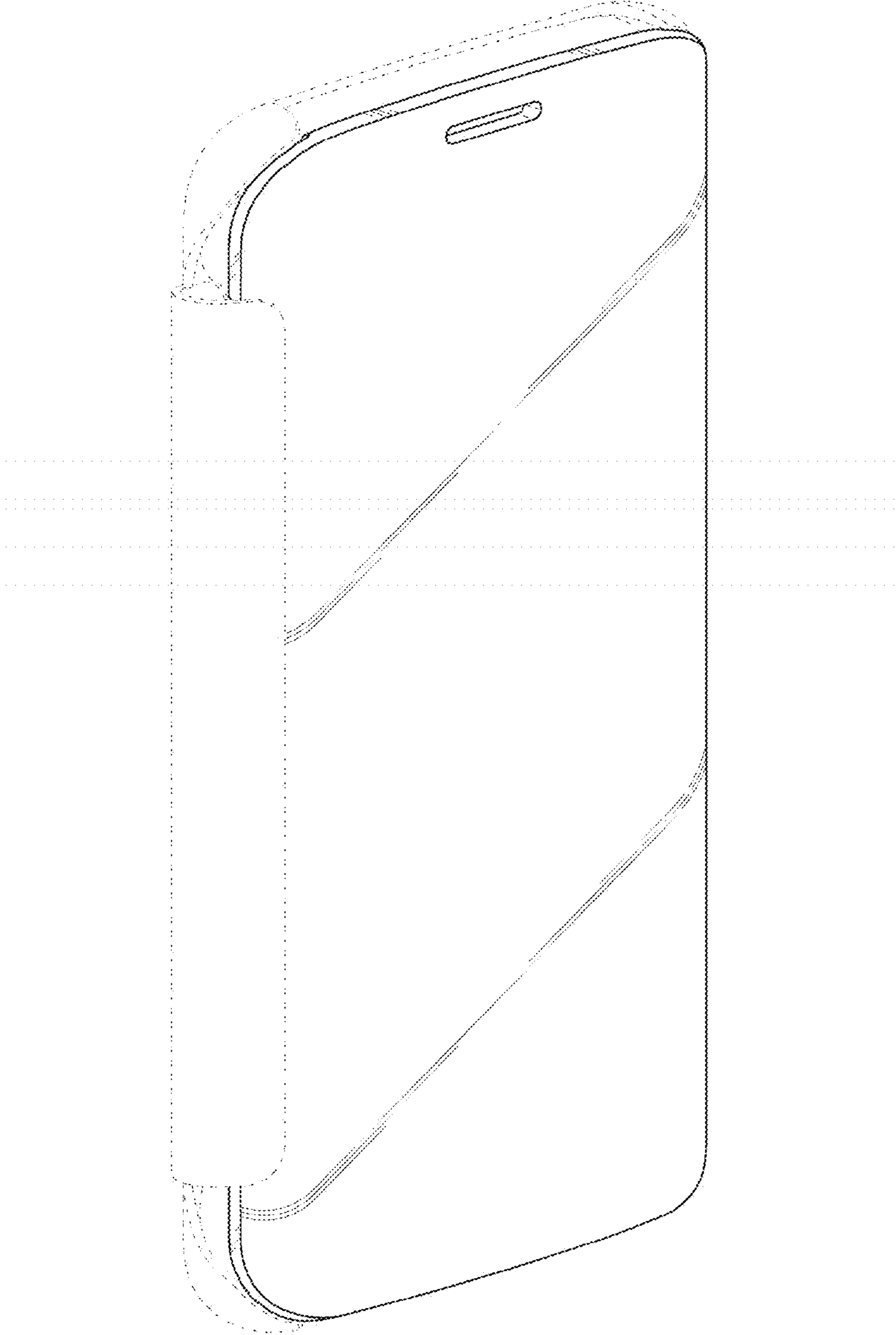

FIG.2

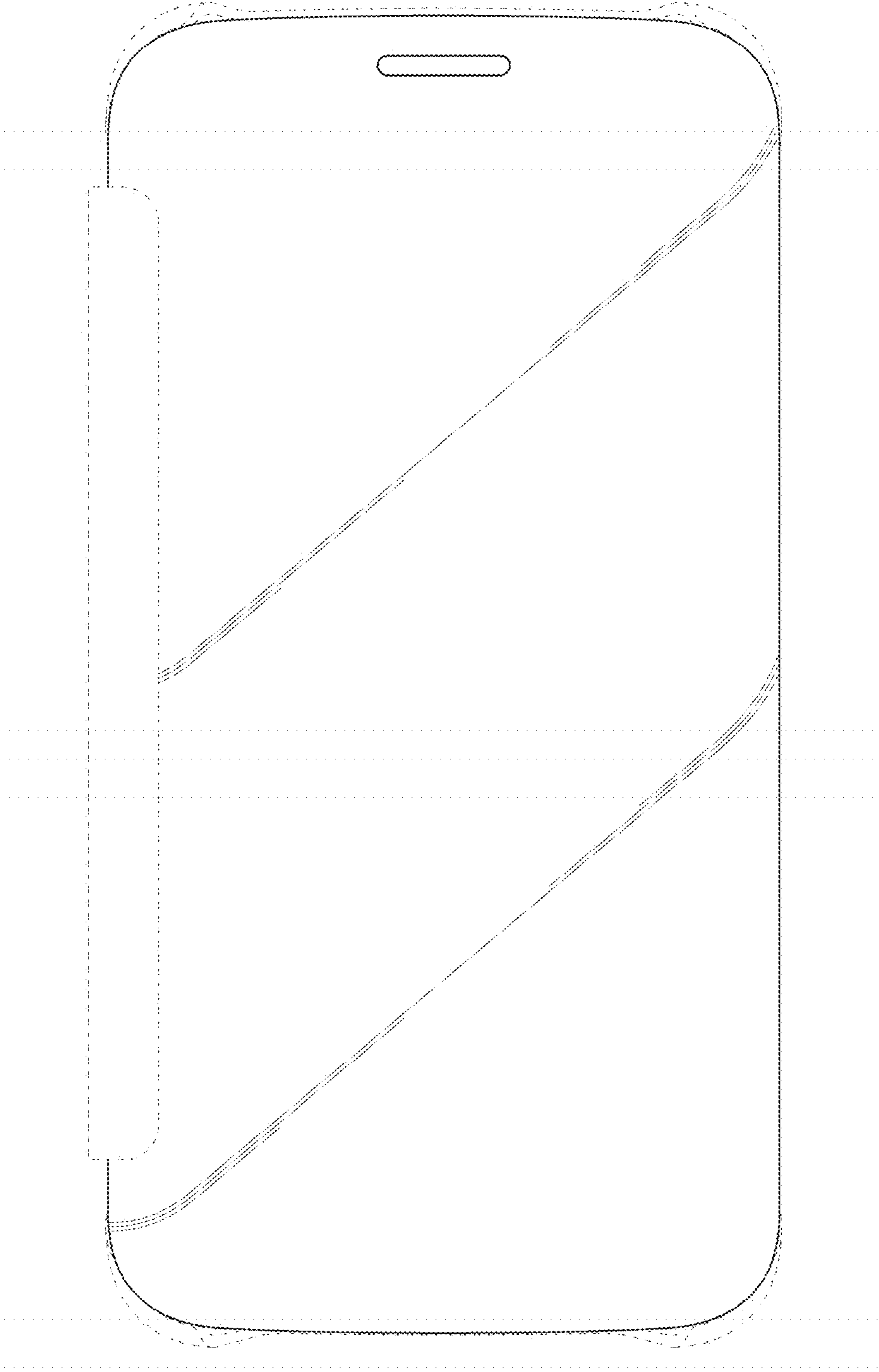

FIG.3

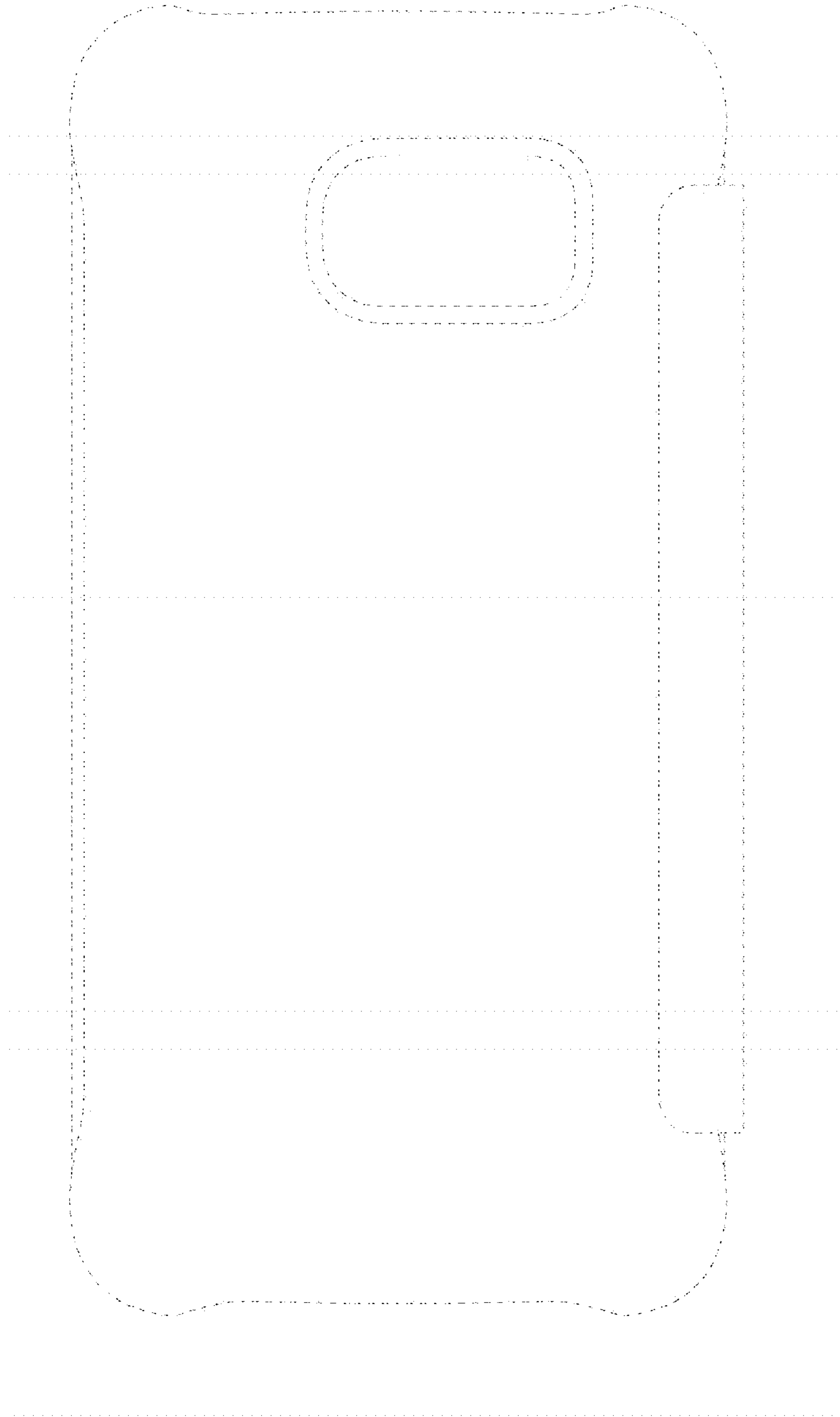

FIG.4

FIG.5

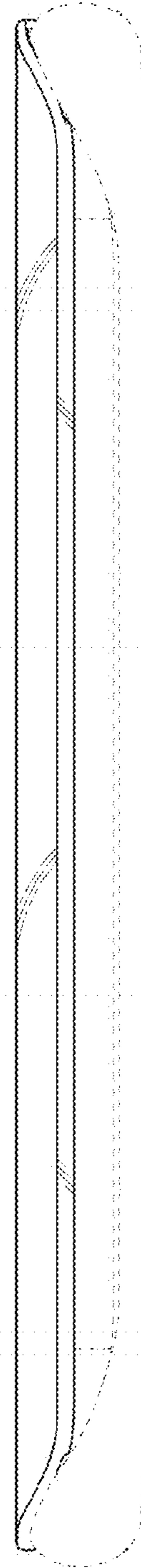
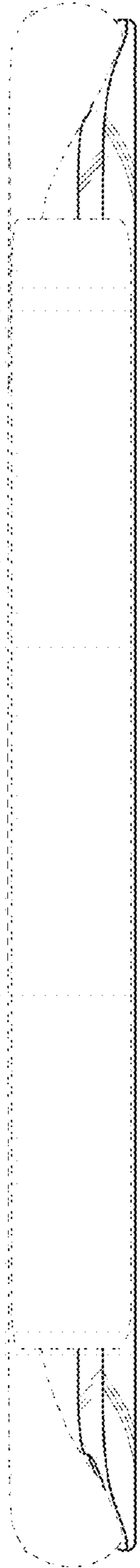

FIG.6

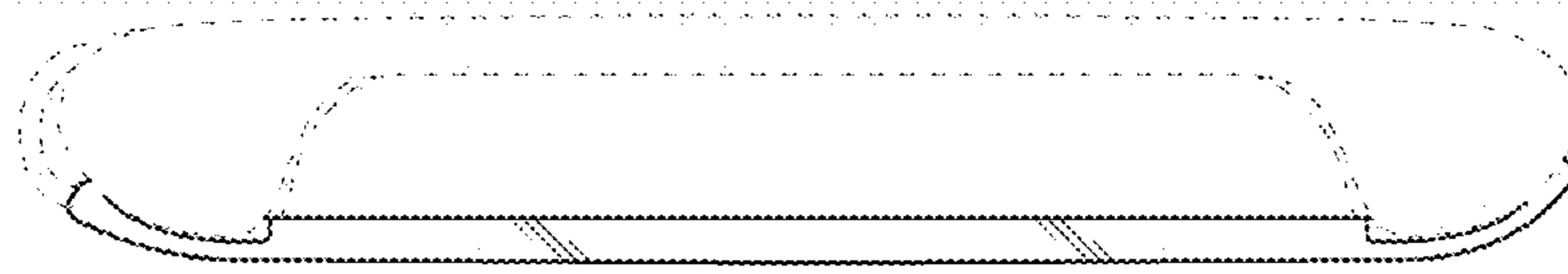

FIG.7

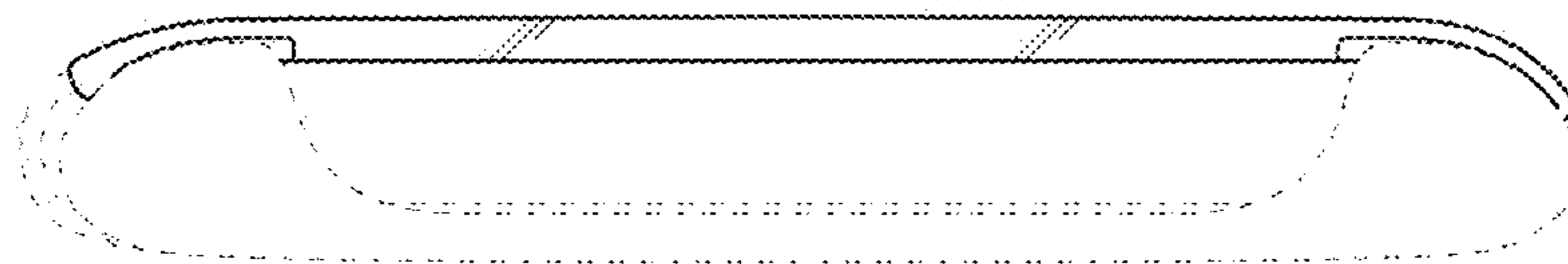

FIG.8

