



US00D777154S

(12) **United States Design Patent**
McGowan et al.

(10) **Patent No.:** **US D777,154 S**
(45) **Date of Patent:** **** Jan. 24, 2017**

(54) **ERGONOMIC CASE WITH ACCESSORY FOR A MOBILE COMMUNICATION DEVICE**

(71) Applicant: **Ambulant, Inc.**, San Rafael, CA (US)

(72) Inventors: **Joseph Cole McGowan**, San Rafael, CA (US); **Harry William McGowan, III**, Chico, CA (US)

(73) Assignee: **AMBULANT, INC.**, San Rafael, CA (US)

(**) Term: **14 Years**

(21) Appl. No.: **29/512,587**

(22) Filed: **Dec. 19, 2014**

(51) **LOC (10) Cl.** **14-03**

(52) **U.S. Cl.**

USPC **D14/250**

(58) **Field of Classification Search**

USPC D14/250, 341, 486, 252, 248, 217, 251, D14/496, 253, 138 AD, 138 R, 138 AA, D14/202, 138 AC; D3/218, 203.2, 201, D3/269; 427/207.1; D13/108, 103; 446/72; 455/559, 575.8, 556.1, 575.1, 455/90.3, 128, 550.1, 556.2; 439/39, 660; 361/679.56, 679.3, 679.55, 679.57, 361/679.46; 312/223.1, 351.1; 248/689, 248/351, 465; 206/320, 37, 45.24, 316.2, 206/701, 811, 522, 587; 364/328.1; 29/428; 345/173; 220/212, 560, 622, 692, 220/782, 784, 788, 628; 292/294, 301, 292/DIG. 47; 224/191

CPC H04B 1/3888; A45C 2011/002; G06F 1/1626; H04M 1/0283

See application file for complete search history.

(56) **References Cited**

U.S. PATENT DOCUMENTS

D619,987 S * 7/2010 Scherf D14/138 AC
D647,085 S * 10/2011 Chung D14/250
D663,294 S * 7/2012 Buxton D14/250

8,560,031 B2 * 10/2013 Barnett F16M 11/10
455/550.1
D711,866 S * 8/2014 Kawata D14/250
D719,951 S * 12/2014 Fenton D14/253
2011/0084081 A1 * 4/2011 Chung A45C 11/00
220/628

(Continued)

OTHER PUBLICATIONS

Wingo Case by Wingo dated Apr. 18, 2014. Found online [Mar. 31, 2016] https://www.facebook.com/wingocase/photos/pb.428637713857720.-2207520000.1459427791./647259375328885/?type=3&theater.*

Primary Examiner — Robert M Spear

Assistant Examiner — Ryan Harvey

(74) *Attorney, Agent, or Firm* — Maschoff Brennan

(57) **CLAIM**

The ornamental design for an ergonomic case with accessory for a mobile communication device, as shown and described.

DESCRIPTION

FIG. 1 is a perspective view of an ergonomic case with accessory for a mobile communication device showing the design in an open configuration of use.

FIG. 2 is a perspective view thereof.

FIG. 3 is a top view thereof.

FIG. 4 is a bottom view thereof.

FIG. 5 is a side thereof.

FIG. 6 is a side view thereof.

FIG. 7 is a side view thereof.

FIG. 8 is a side view thereof.

FIG. 9 is a perspective view thereof, shown in a closed configuration.

FIG. 10 is a perspective view thereof.

FIG. 11 is a top view thereof.

FIG. 12 is a bottom view thereof.

FIG. 13 is a side view thereof.

FIG. 14 is a side view thereof.

FIG. 15 is a side view thereof; and,

FIG. 16 is a side view thereof.

(Continued)

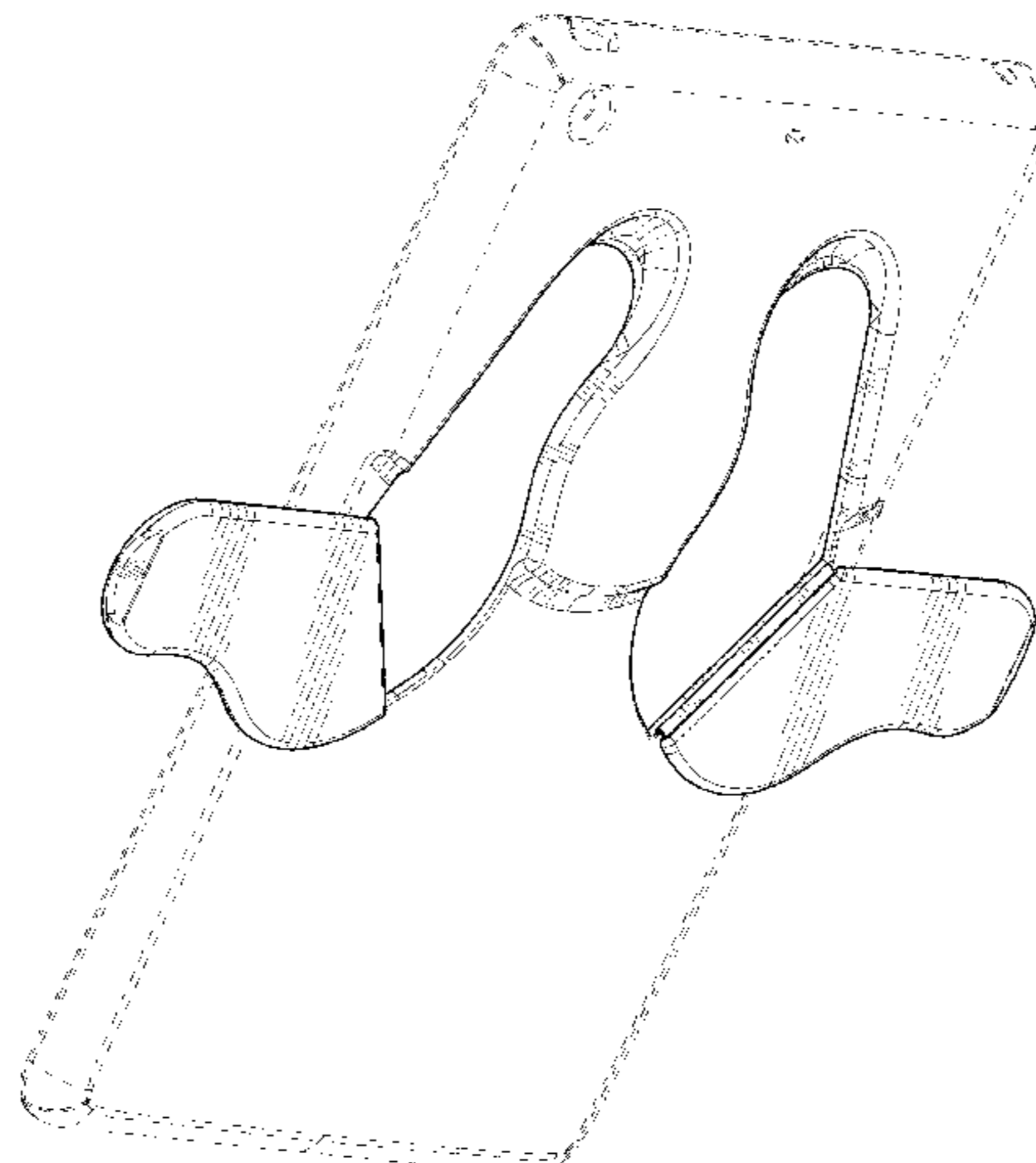

The broken lines illustrate portions of the article that form no part of the claimed design. The claims are not directed to a surface between a solid line and a dashed line.

1 Claim, 12 Drawing Sheets

(56) **References Cited**

U.S. PATENT DOCUMENTS

2014/0124388 A1* 5/2014 McGowan G06F 1/1626
206/37
2015/0175309 A1* 6/2015 McGowan B65D 25/2882
224/191

* cited by examiner

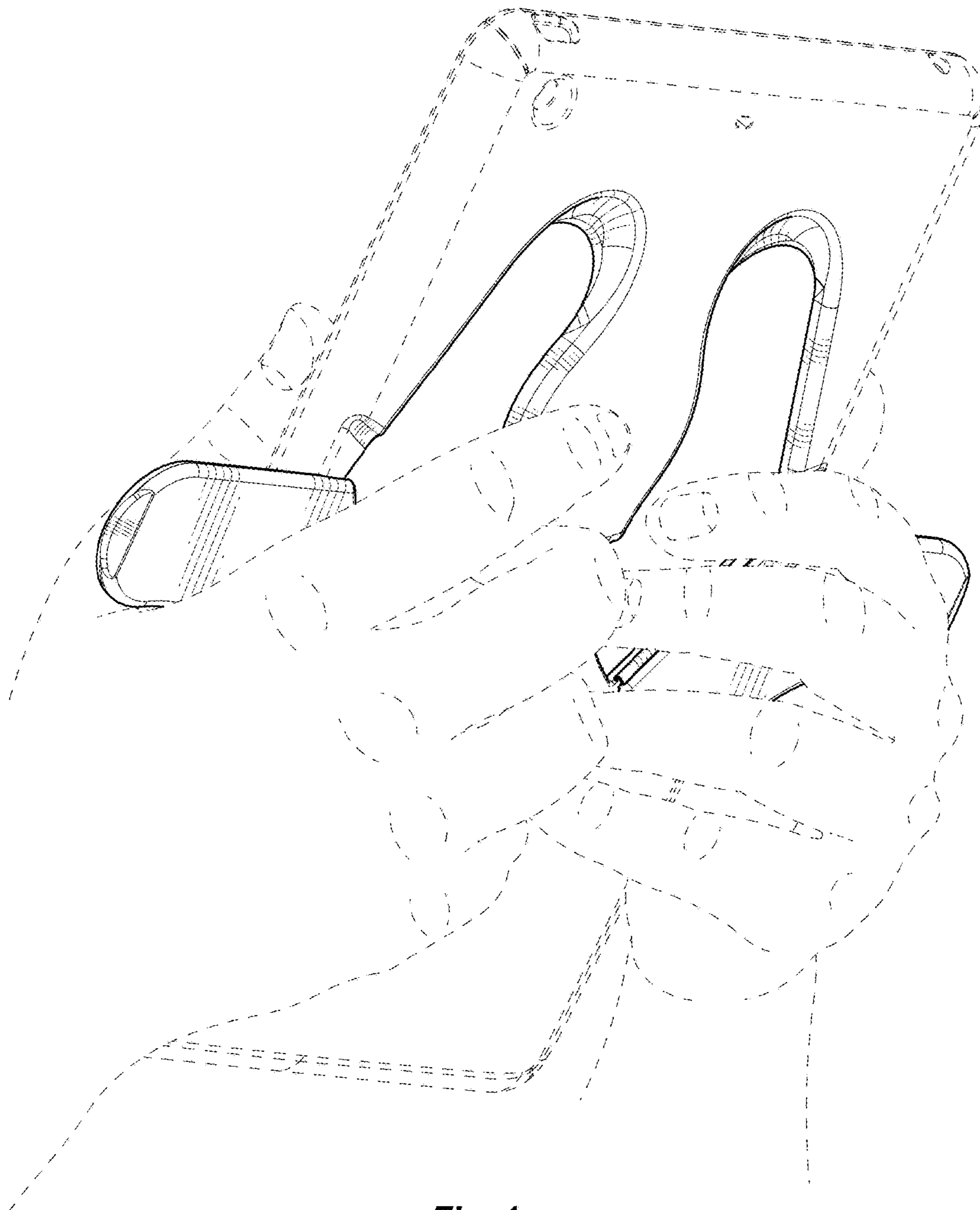

Fig. 1

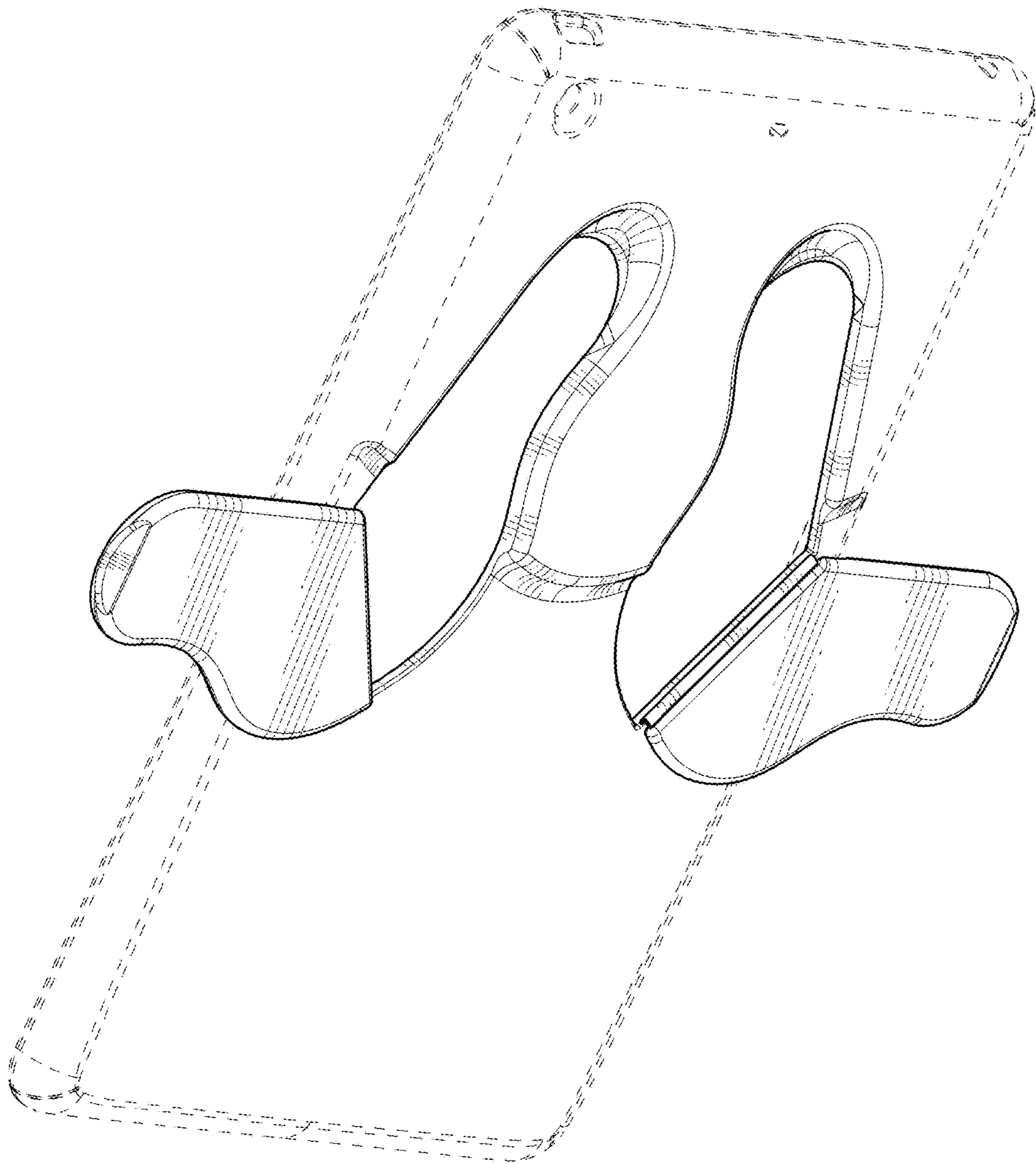

Fig. 2

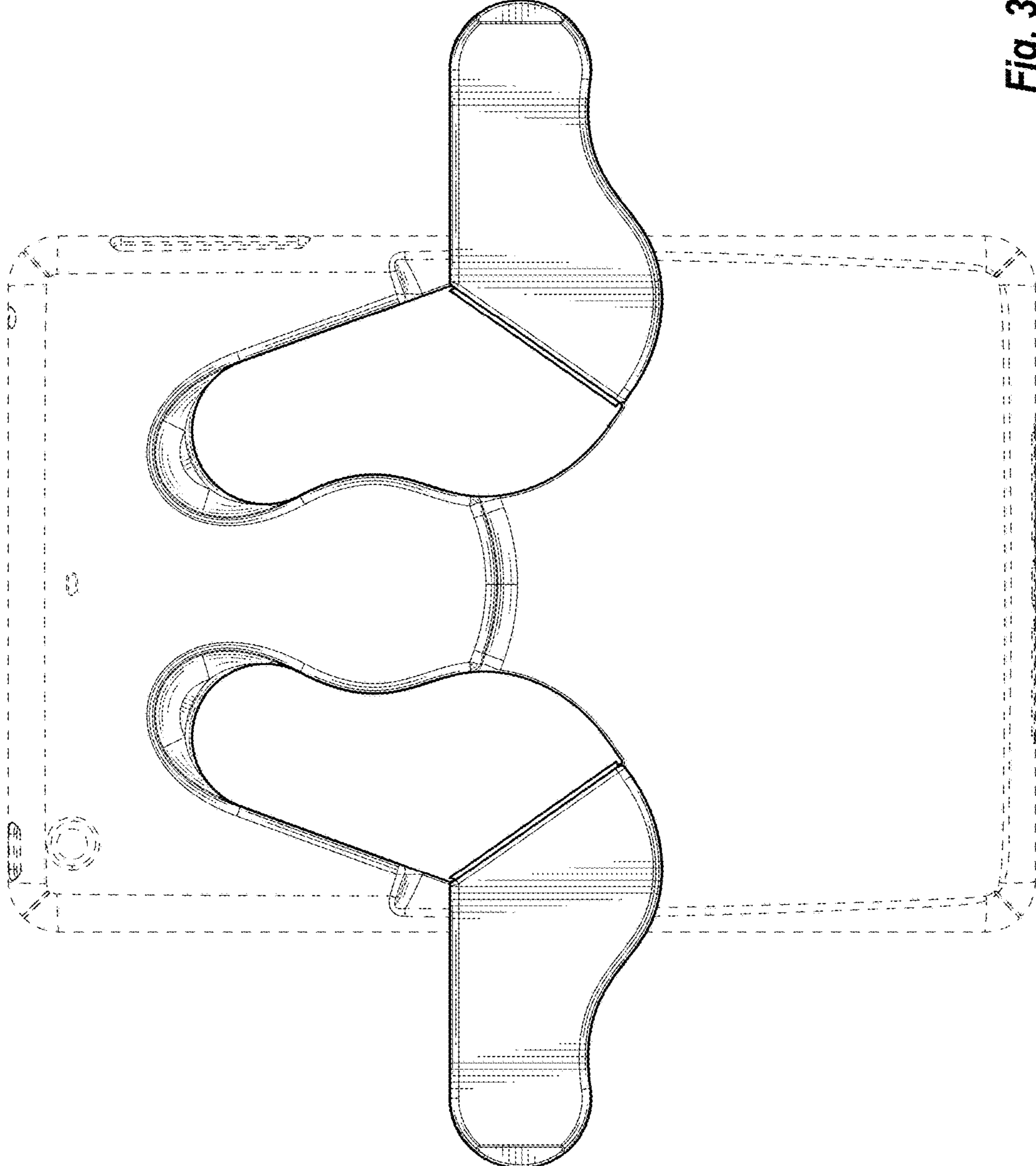

Fig. 3

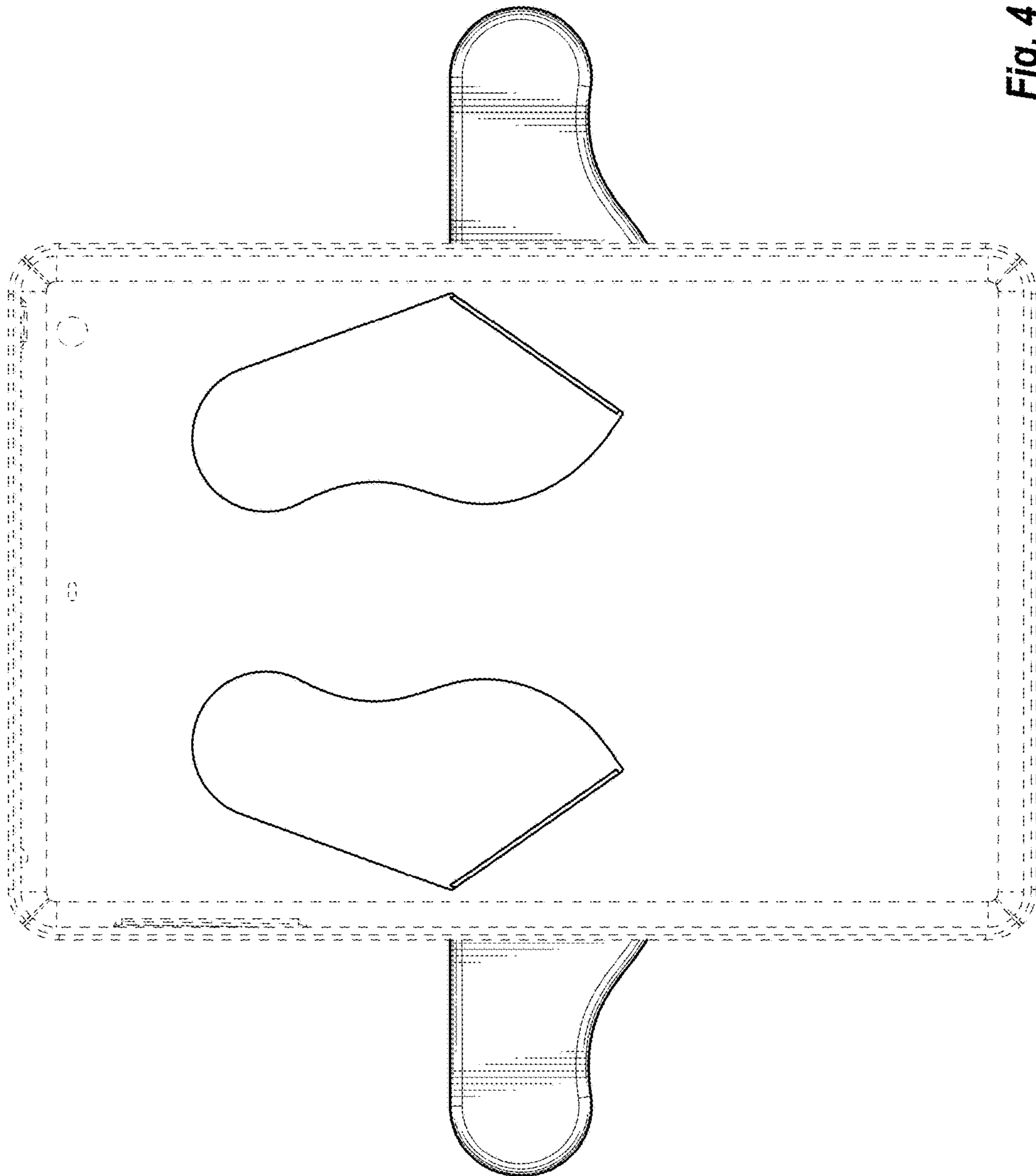

Fig. 4

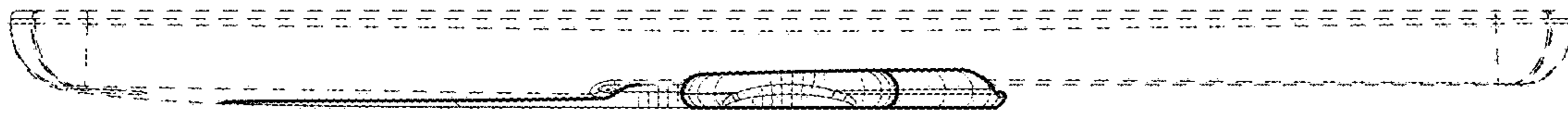

Fig. 6

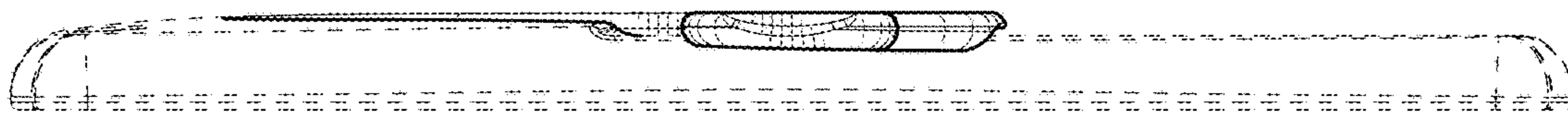

Fig. 5

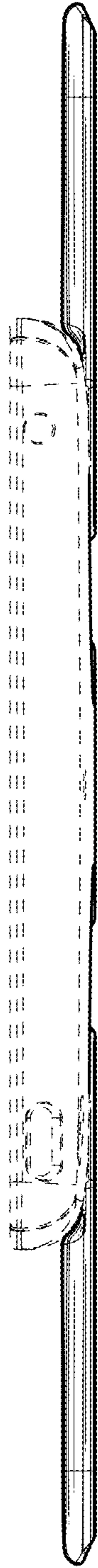

Fig. 7

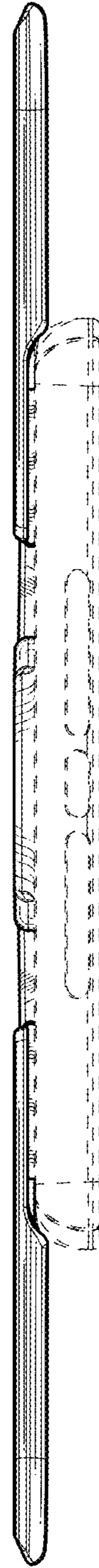

Fig. 8

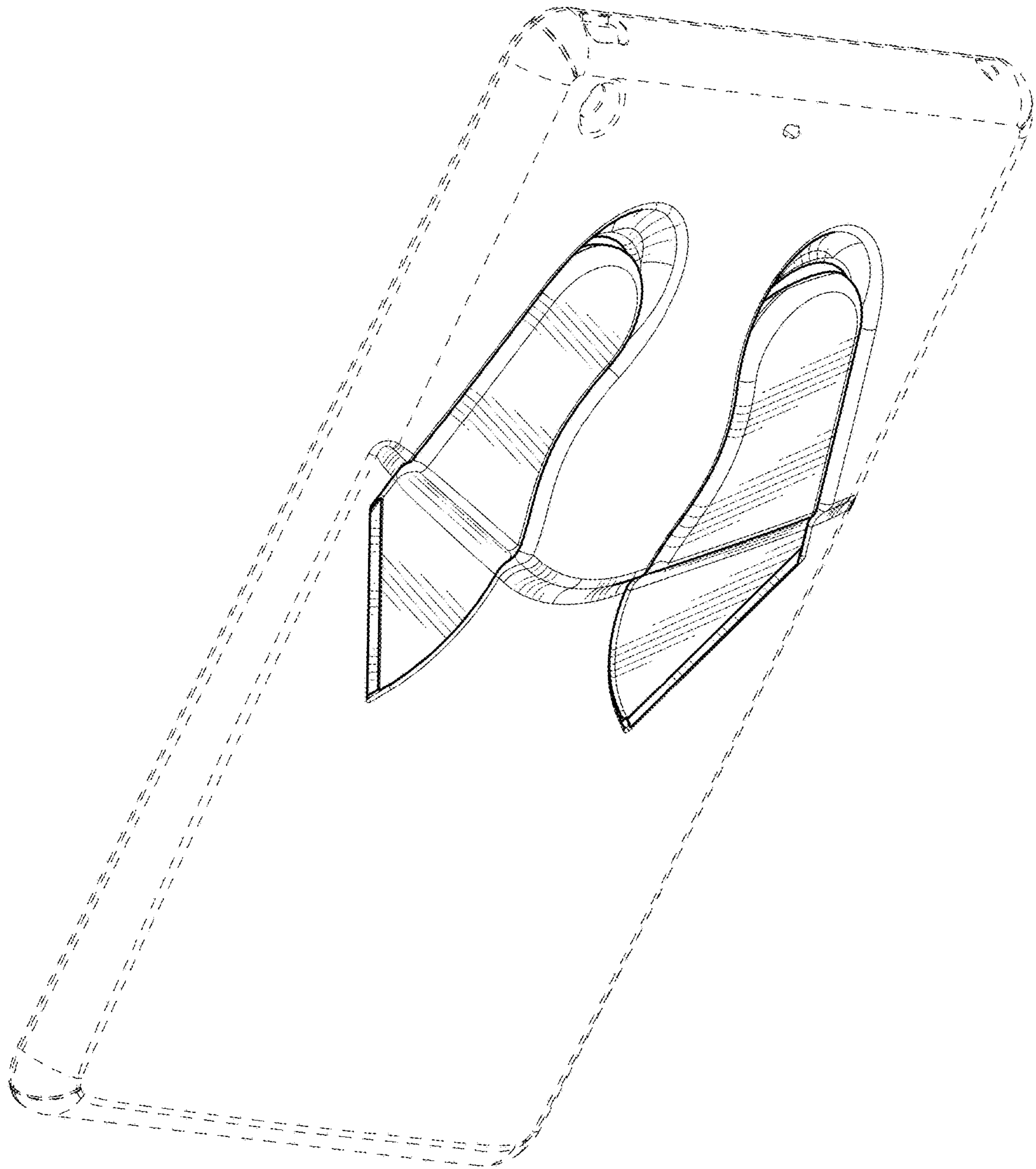

Fig. 9

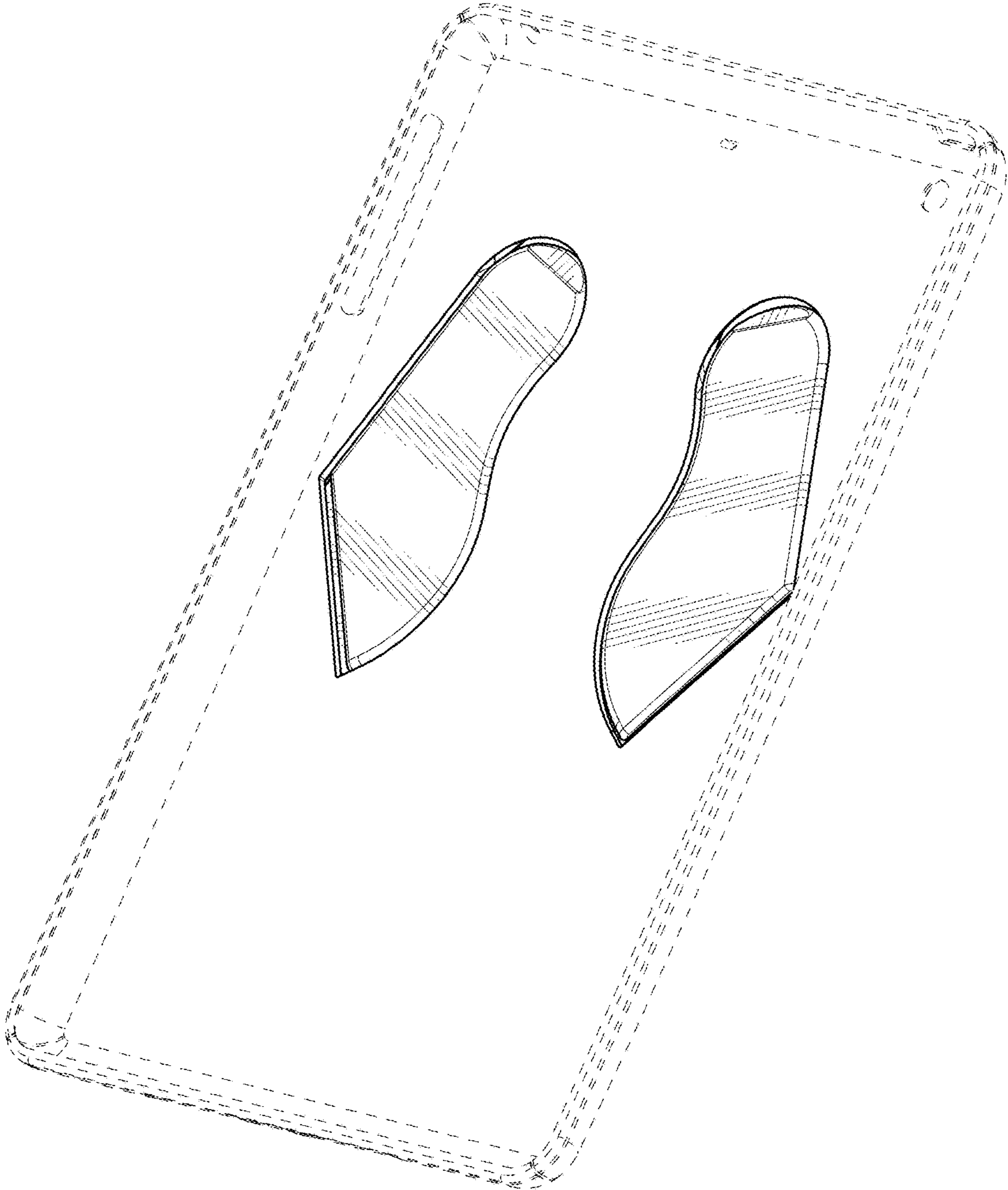

Fig. 10

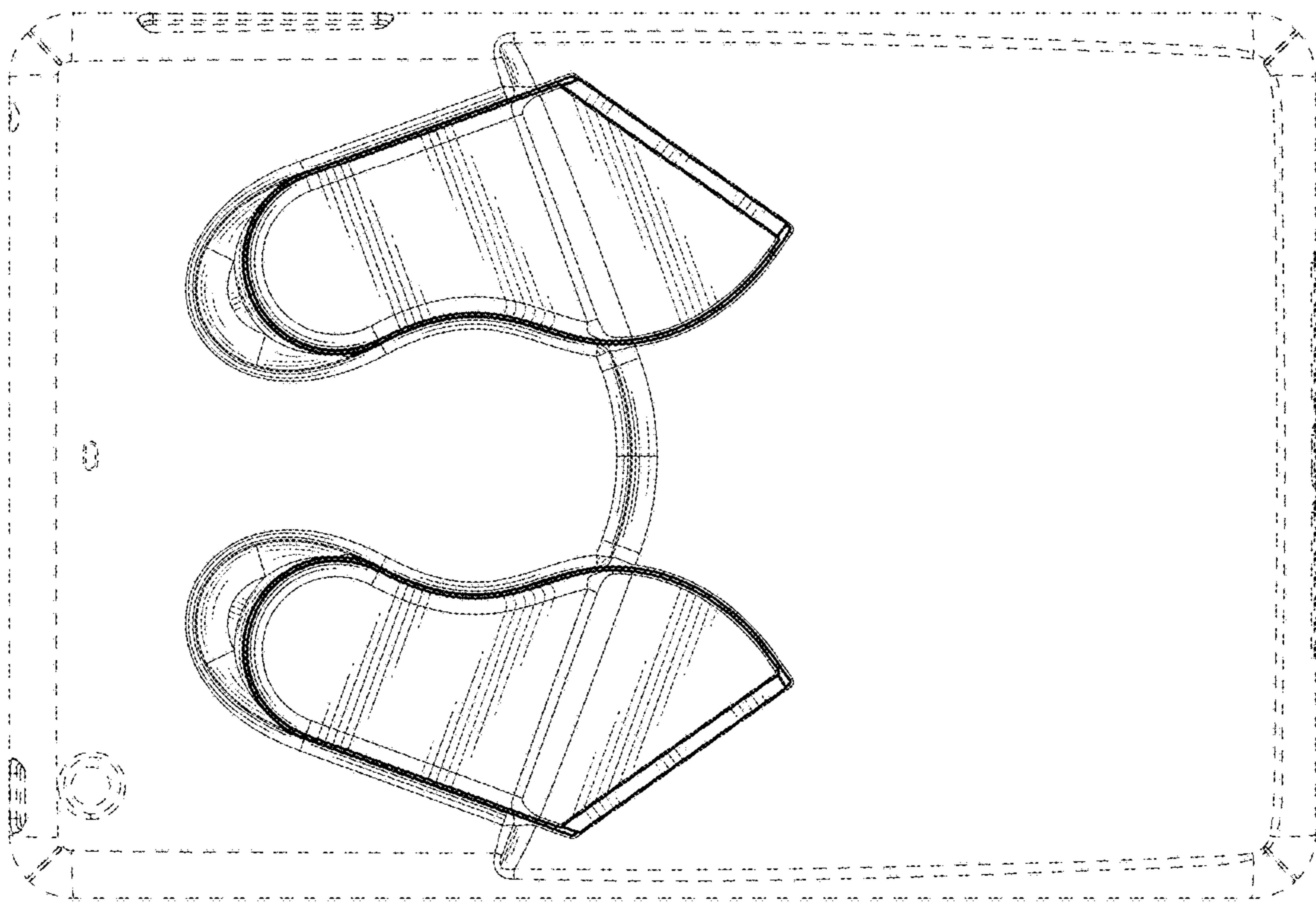

Fig. 11

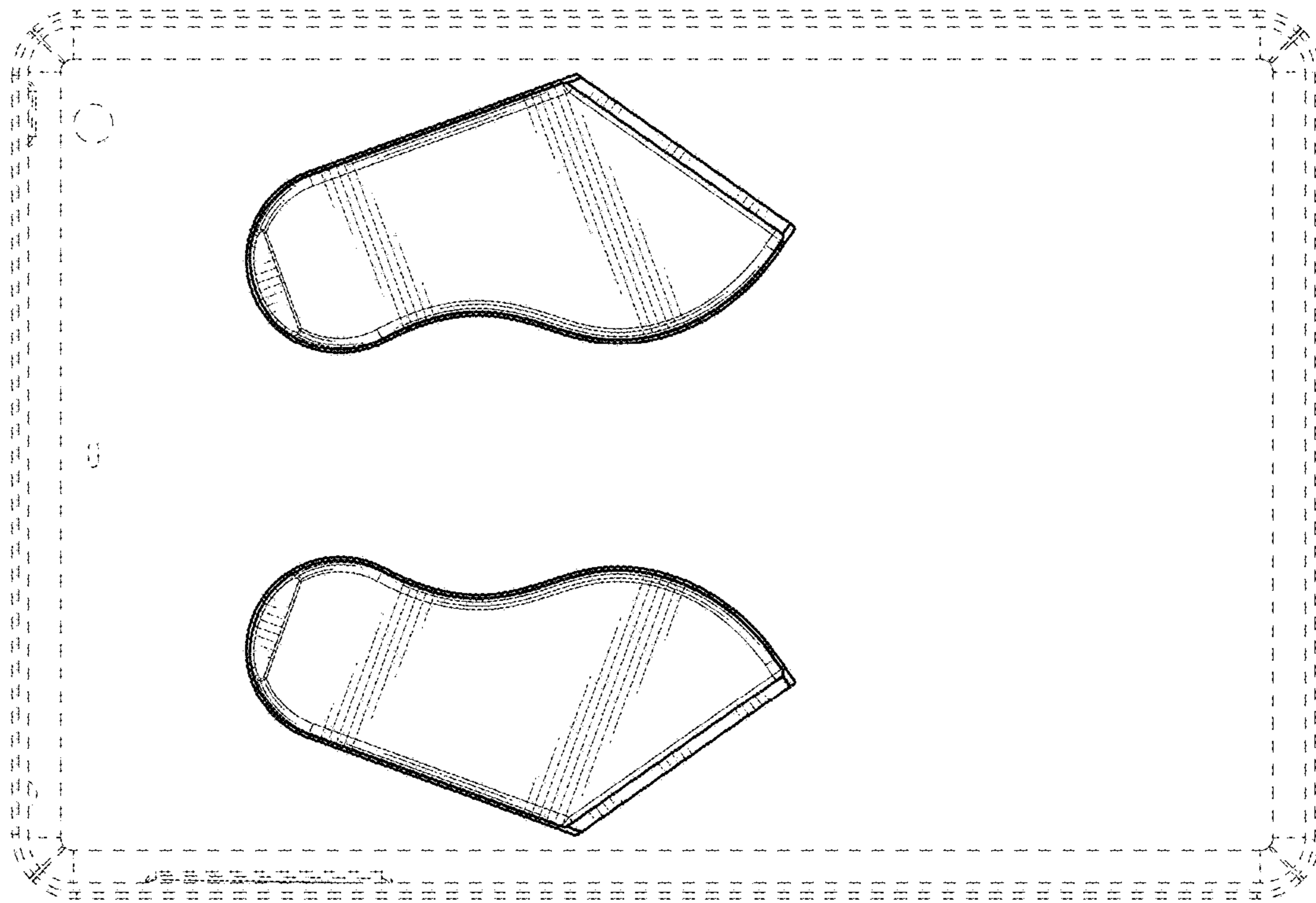

Fig. 12

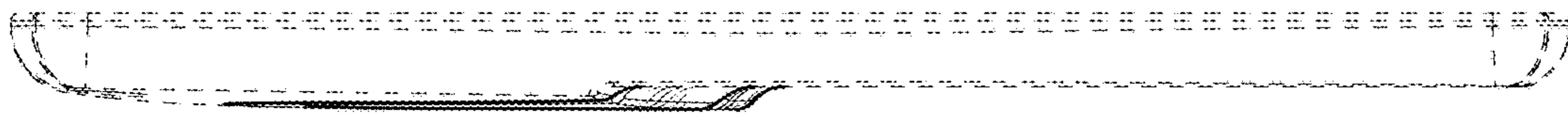

Fig. 14

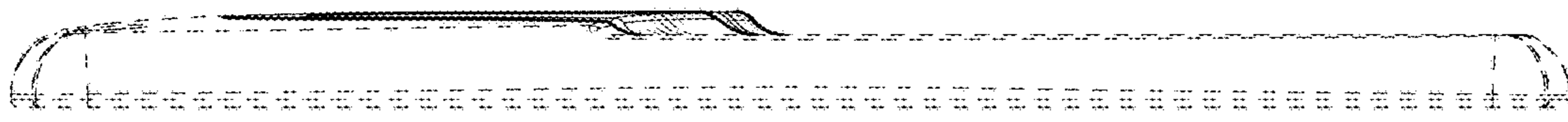

Fig. 13



Fig. 15

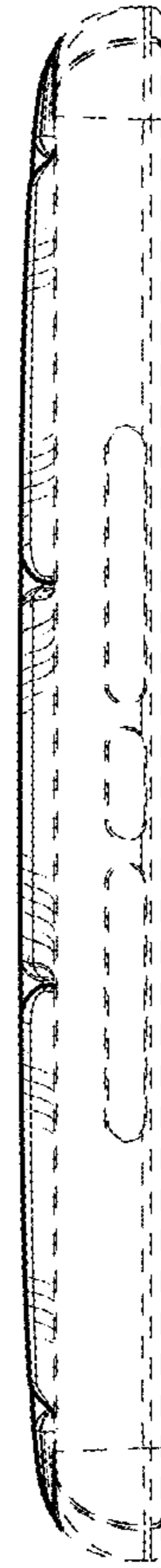

Fig. 16