



US00D777135S

(12) **United States Design Patent**
Jang et al.

(10) **Patent No.:** **US D777,135 S**
(45) **Date of Patent:** **** Jan. 24, 2017**

- (54) **TELEPHONE**
- (71) Applicant: **Samsung Electronics Co., Ltd.**,
Suwon-si, Gyeonggi-do (KR)
- (72) Inventors: **Moonjung Jang**, Gunpo-si (KR); **Jihe Kwak**, Seoul (KR); **Soyoon Jeon Jeon**,
Guri-si (KR)
- (73) Assignee: **SAMSUNG ELECTRONICS CO., LTD.**,
Suwon-si, Gyeonggi-Do (KR)
- (**) Term: **15 Years**
- (21) Appl. No.: **29/531,573**
- (22) Filed: **Jun. 26, 2015**
- (30) **Foreign Application Priority Data**

Jan. 20, 2015 (KR) 30-2015-0002820

- (51) **LOC (10) Cl.** **14-03**
- (52) **U.S. Cl.**
USPC **D14/149; D14/151**
- (58) **Field of Classification Search**
USPC D14/140, 140.1, 140.7, 140.8, 141.2,
D14/142, 147, 148, 149, 151, 150, 158,
D14/159, 188, 217, 240, 243, 247, 248,
D14/251, 299, 329; D21/517; D18/1, 7;
D10/104.1; 455/557, 575, 575.1, 575.2,
455/575.3, 575.4, 74.1; 710/303;
379/88.17, 90.01, 93.17, 387.01, 388.02,
379/419-420.04, 428.01-428.04,
379/434-436, 440, 446-447,
379/454-455, 93.23
CPC H04M 1/00; H04M 1/003; H04M 1/02;
H04M 1/03; H04M 1/04; H04M 1/0202;
H04M 1/0297; H04M 1/20; H04M 1/21;
H04M 1/22; H04M 1/23; H04M 1/233;
H04M 1/236
See application file for complete search history.

(56) **References Cited**
U.S. PATENT DOCUMENTS

D279,005 S * 5/1985 Genaro D14/248
D280,324 S * 8/1985 Endt D14/151

D282,841 S * 3/1986 Inaba D14/151
4,675,903 A * 6/1987 Gulezian H04M 1/03
379/429
D293,103 S * 12/1987 Gauffin D14/151
D294,500 S * 3/1988 Drakulovic 379/433.01
D295,514 S * 5/1988 Inaba D14/151
D298,939 S * 12/1988 Morikawa D14/151
D299,647 S * 1/1989 Davies D14/248
D300,926 S * 5/1989 Morikawa D14/151
D301,031 S * 5/1989 Sasaki D14/151
D301,339 S * 5/1989 Gauffin D14/151
D303,390 S * 9/1989 Ohta D14/142
D318,276 S * 7/1991 Fuqua D14/151
D321,873 S * 11/1991 Ando D14/151
D321,874 S * 11/1991 Ando D14/151
D321,875 S * 11/1991 Ando D14/151
D323,164 S * 1/1992 Myoga D14/138 R
D351,165 S * 10/1994 Hillenmayer D14/151
D364,622 S * 11/1995 Hillenmayer D14/151

(Continued)

Primary Examiner — Susan Bennett Hattan
Assistant Examiner — Marie Fast Horse
(74) *Attorney, Agent, or Firm* — Ladas & Parry LLP

(57) **CLAIM**

We claim the ornamental design for a telephone, as shown and described.

DESCRIPTION

FIG. 1 is the front perspective view of a telephone showing our new design;
FIG. 2 is the front view thereof;
FIG. 3 is the rear view thereof;
FIG. 4 is the left-side view thereof;
FIG. 5 is the right-side view thereof;
FIG. 6 is the top plan view thereof; and,
FIG. 7 is the bottom plan view thereof.
The broken line consisting of unevenly sized dashes defines the boundary of the claim, which extends to the boundary but does not include the boundary; while all other broken lines in the drawing depict portions of the telephone that form no part of the claim.

1 Claim, 7 Drawing Sheets

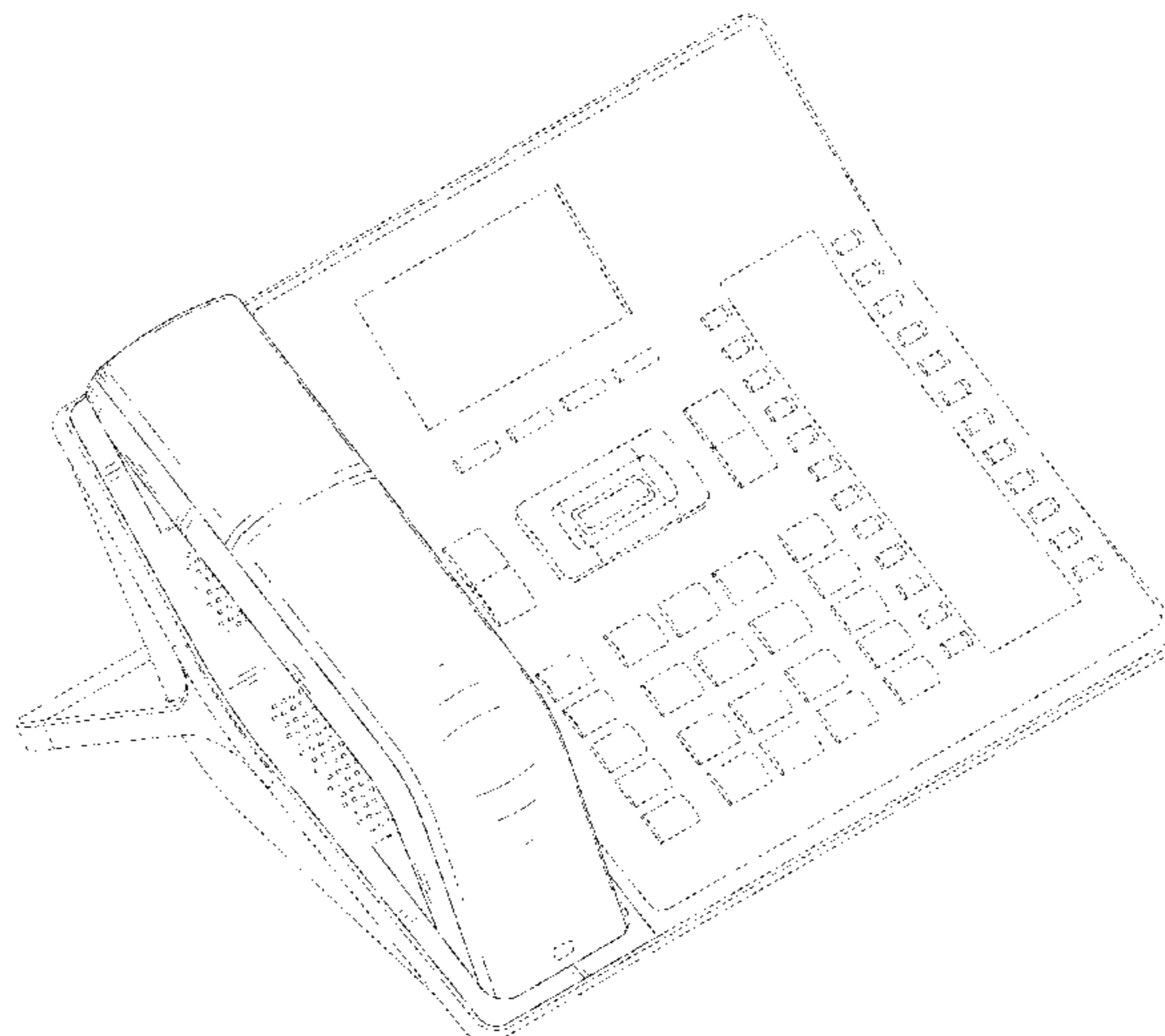

(56)

References Cited

U.S. PATENT DOCUMENTS

D374,667	S *	10/1996	Elkins	D14/151
D375,095	S *	10/1996	Hillenmayer	D14/151
D381,981	S *	8/1997	Johansson	D14/151
D405,447	S *	2/1999	Landry	D14/151
D412,171	S *	7/1999	Girardi	D14/151
D464,035	S *	10/2002	Nam	D14/151
D470,830	S *	2/2003	Weidinger	D14/151
D499,712	S *	12/2004	Abe	D14/151
D536,328	S *	2/2007	Chou	D14/151
D551,203	S *	9/2007	Abe	D14/151
D552,071	S *	10/2007	Park	D14/151
D558,181	S *	12/2007	Takada	D14/142
D558,730	S *	1/2008	Nakashima	D14/151
D575,262	S *	8/2008	Brown	D14/151
D575,263	S *	8/2008	Brown	D14/151
D582,886	S *	12/2008	Woo	D14/151
D723,502	S *	3/2015	Chun	D14/130
D739,372	S *	9/2015	Ferriell	D14/142
D739,373	S *	9/2015	Hillenmayer	D14/144
D750,591	S *	3/2016	Katori	D14/149
2003/0059005	A1 *	3/2003	Meyerson	H04L 12/58 379/88.17
2005/0069126	A1 *	3/2005	Xue	H04M 1/12 379/454
2006/0058003	A1 *	3/2006	Lee	H04M 1/2535 455/403
2009/0283655	A1 *	11/2009	Fukuda	F16M 11/10 248/454
2010/0322410	A1 *	12/2010	Lin	H04M 1/0295 379/428.03

* cited by examiner

FIG. 1

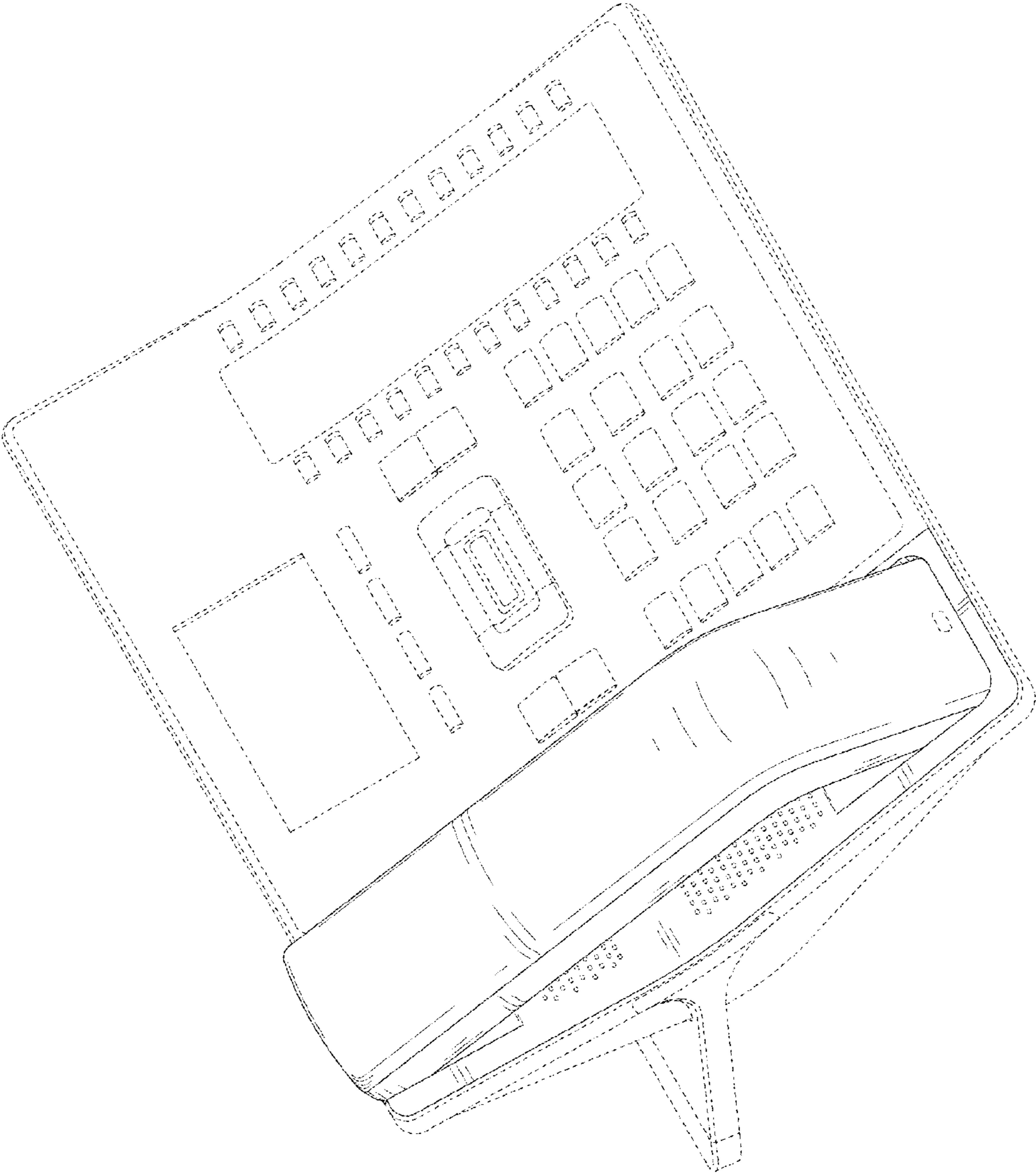

FIG. 2

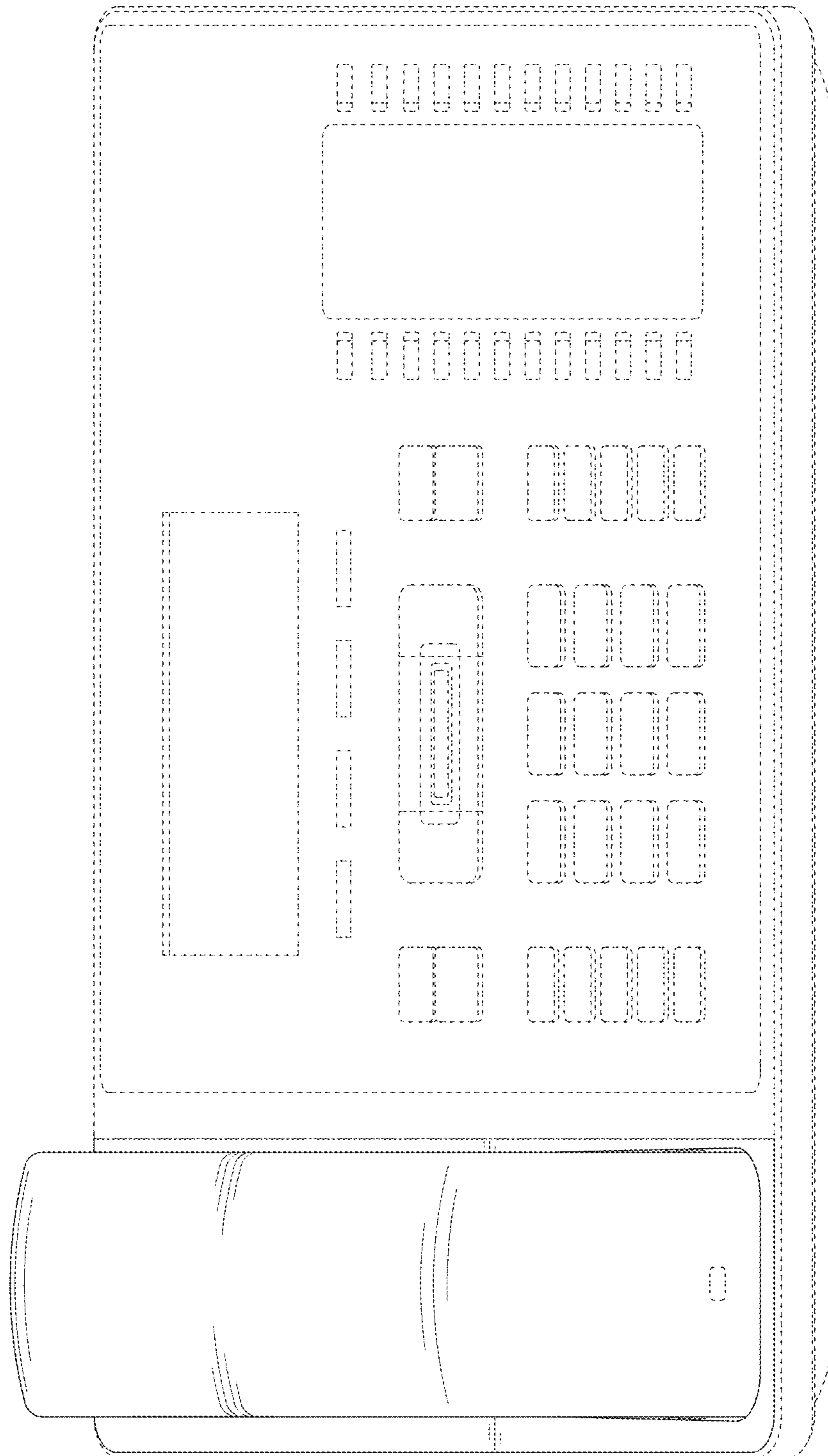

FIG. 3

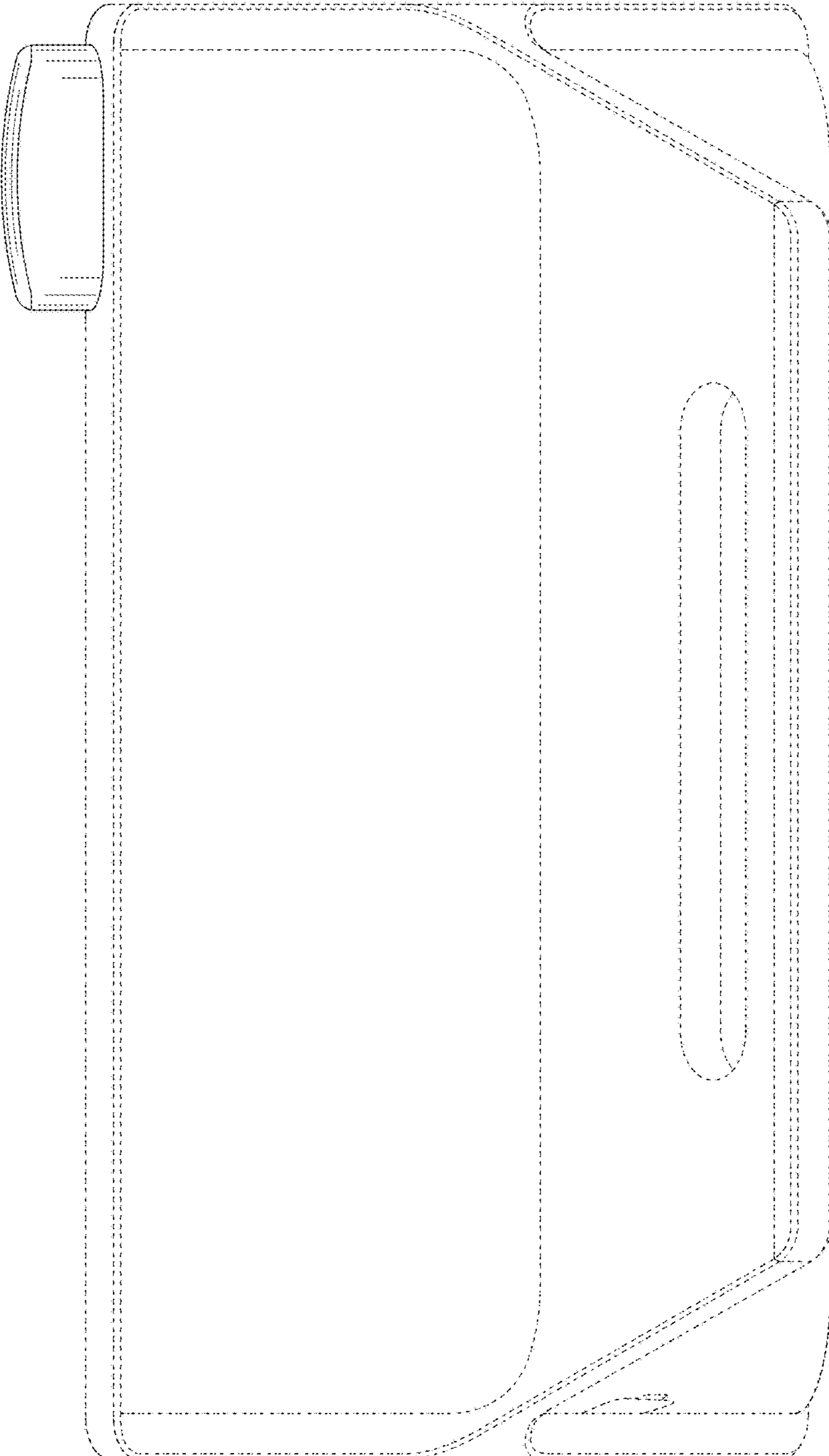

FIG. 4

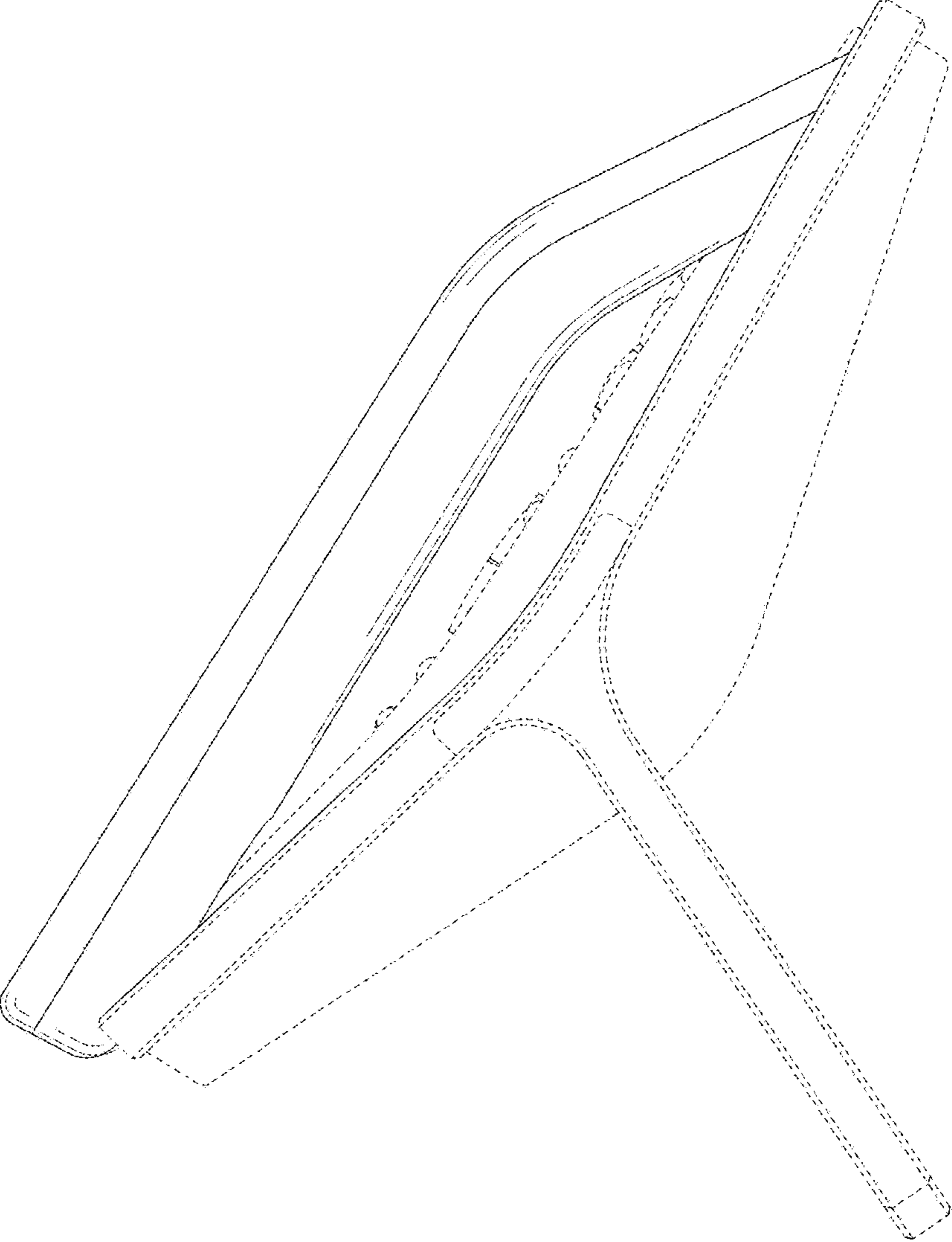

FIG. 5

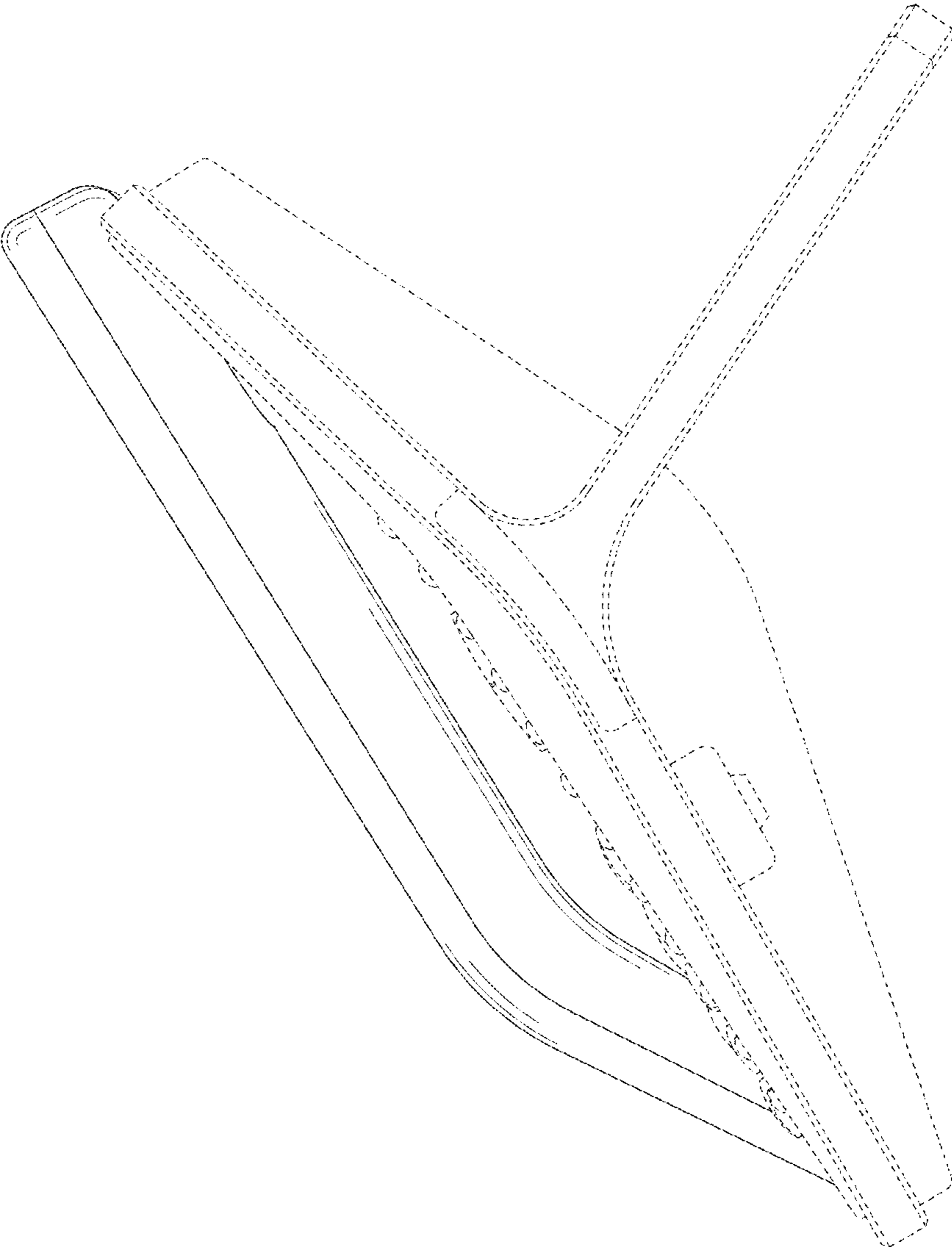

FIG. 6

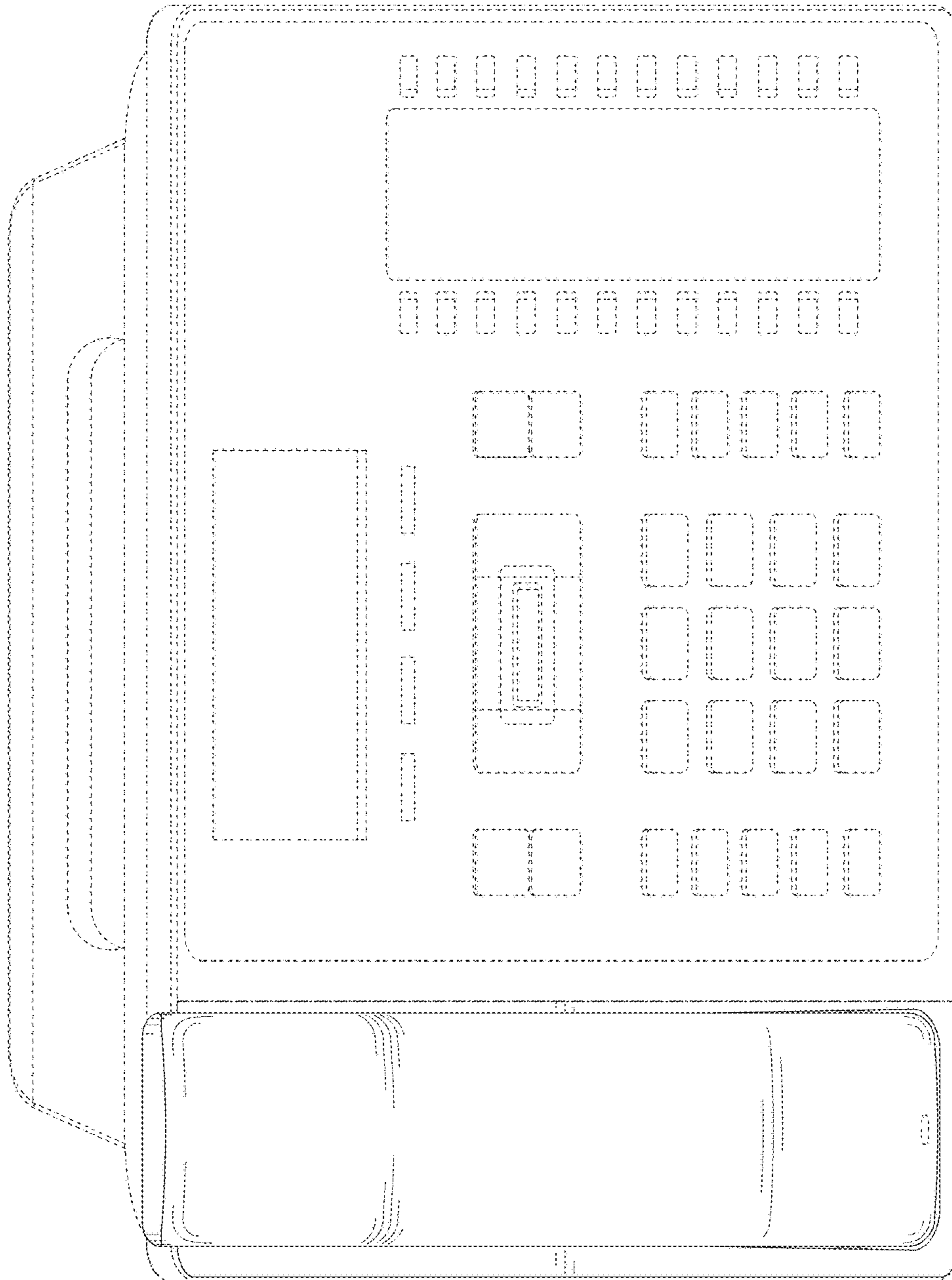

FIG. 7

