



US00D777126S

(12) **United States Design Patent**
Odryna et al.

(10) **Patent No.:** **US D777,126 S**

(45) **Date of Patent:** **** Jan. 24, 2017**

(54) **SET TOP BOX**

D650,394 S * 12/2011 Seoc D14/496
D692,849 S * 11/2013 Choi D14/188
D699,694 S * 2/2014 Son D14/125

(71) Applicant: **Layer3 TV, Inc.**, Denver, CO (US)

* cited by examiner

(72) Inventors: **Vic Odryna**, Boston, MA (US); **Eric Kuhn**, Los Angeles, CA (US); **Jeffrey Binder**, Denver, CO (US); **Dave Fellows**, Boston, MA (US); **Andre De Salis**, Pasadena, CA (US); **Eduardo Salazar**, Reseda, CA (US); **John Schoenbeck**, Calabasas, CA (US); **Timothy R. Swiss**, Carlsbad, CA (US)

Primary Examiner — Randall Gholson

(74) *Attorney, Agent, or Firm* — Brownstein Hyatt Farber Schreck, LLP

(73) Assignee: **LAYER3 TV, INC.**, Denver, CO (US)

(57) **CLAIM**

(**) Term: **15 Years**

The ornamental design for a set top box, as shown and described.

(21) Appl. No.: **29/533,075**

(22) Filed: **Jul. 14, 2015**

DESCRIPTION

(51) **LOC (10) Cl.** **14-03**

(52) **U.S. Cl.**
USPC **D14/125**

(58) **Field of Classification Search**
USPC D14/125, 357–358, 496, 188, 242, 432;
D13/184; 348/10, 460, 706, 731;
340/825.03; 455/6.1, 6.2; 312/223.1, 7.2
CPC H04N 21/00; H04N 21/20; H04N 21/40
See application file for complete search history.

FIG. 1 is a front right side perspective view of a set top box showing our new design;
FIG. 2 is a front view thereof;
FIG. 3 is a right side view thereof;
FIG. 4 is a top view thereof;
FIG. 5 is a rear view thereof;
FIG. 6 is a bottom view thereof; and,
FIG. 7 is a left side view thereof.

(56) **References Cited**

U.S. PATENT DOCUMENTS

D513,617 S * 1/2006 Tierney D14/496
D525,968 S * 8/2006 Peng D14/300
D526,648 S * 8/2006 Andre D14/314
D601,583 S * 10/2009 Andre D14/496

The broken lines depict portions of the set top box that form no part of the claimed design.

1 Claim, 7 Drawing Sheets

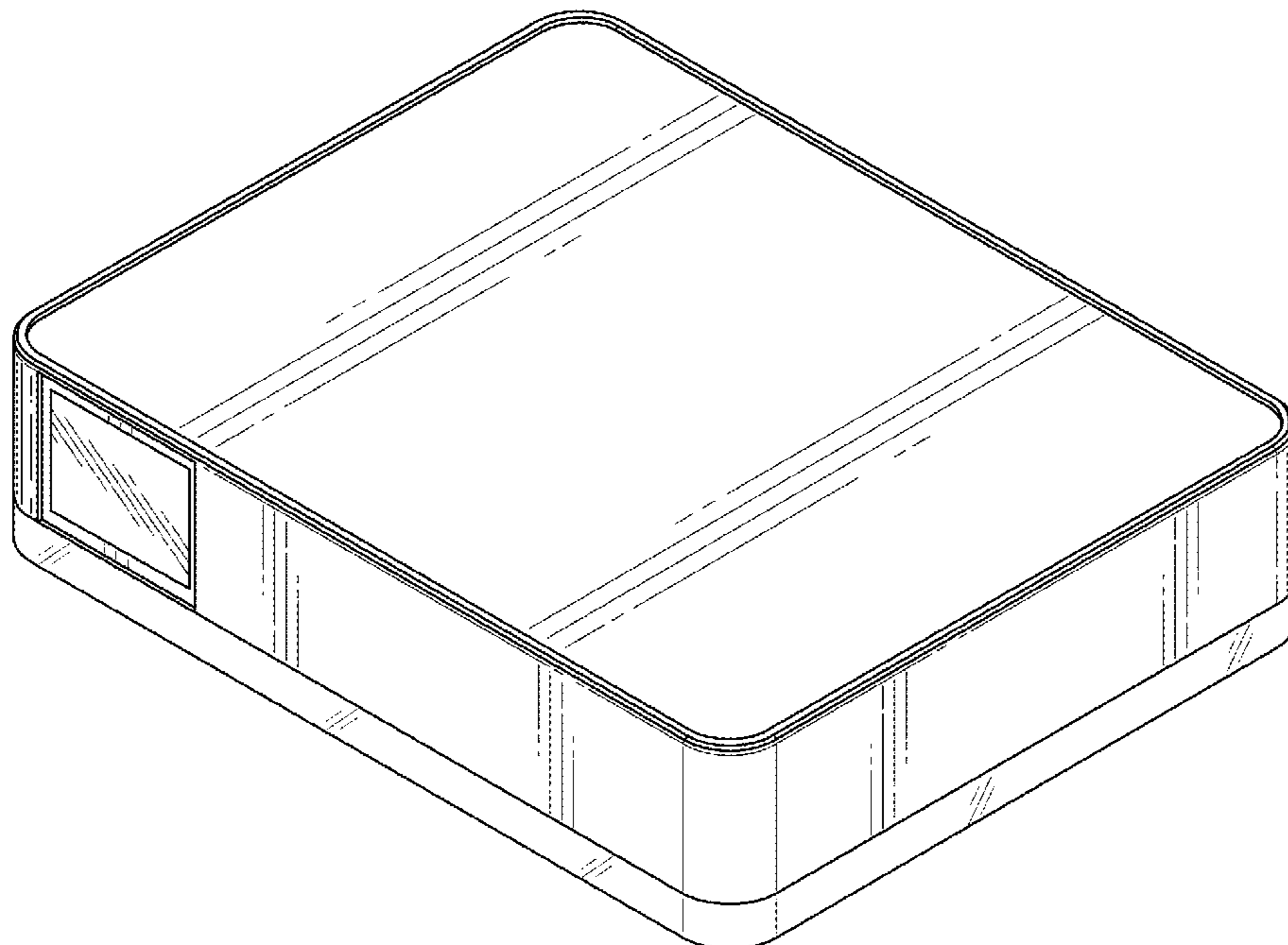

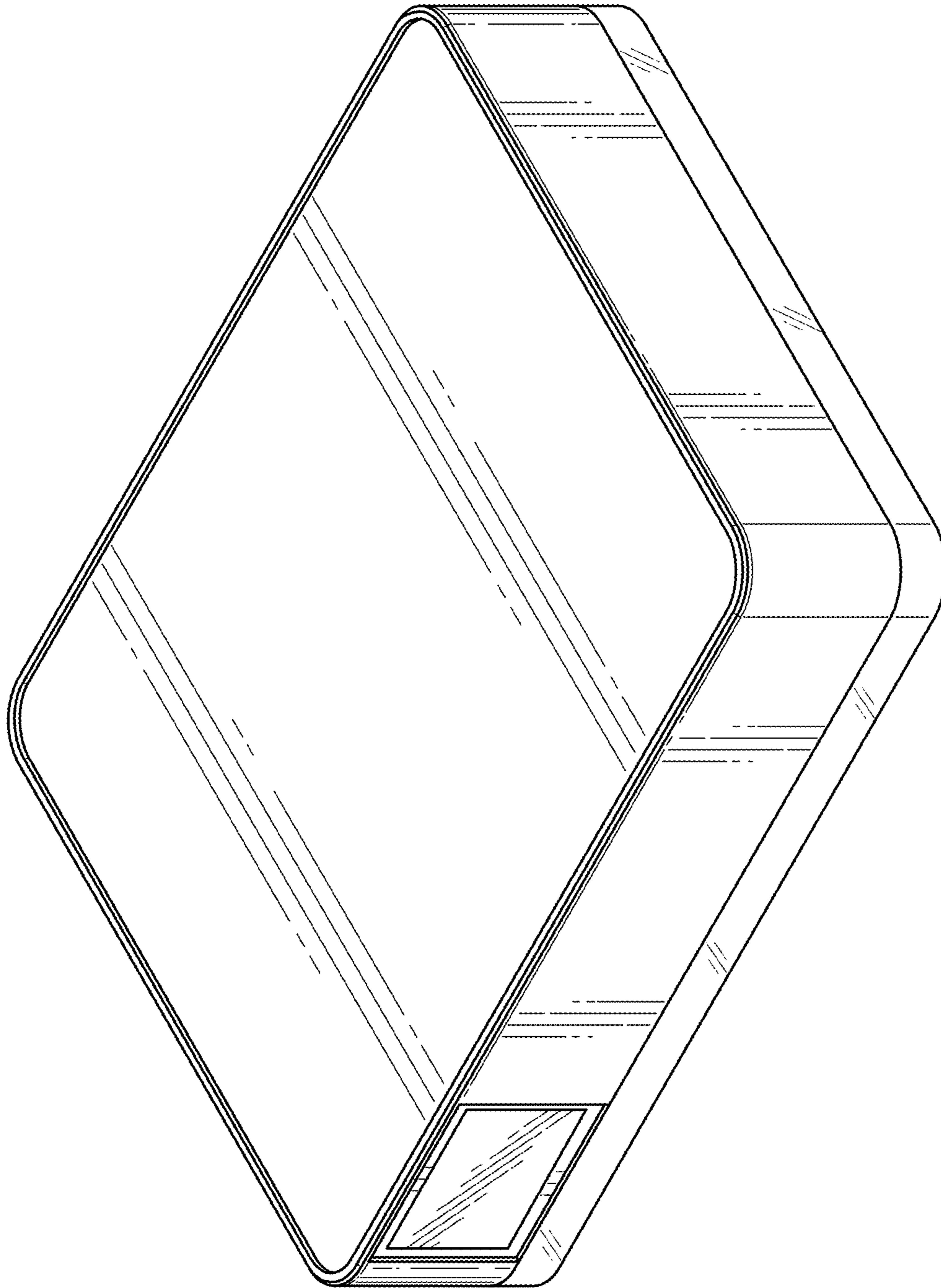

FIG. 1

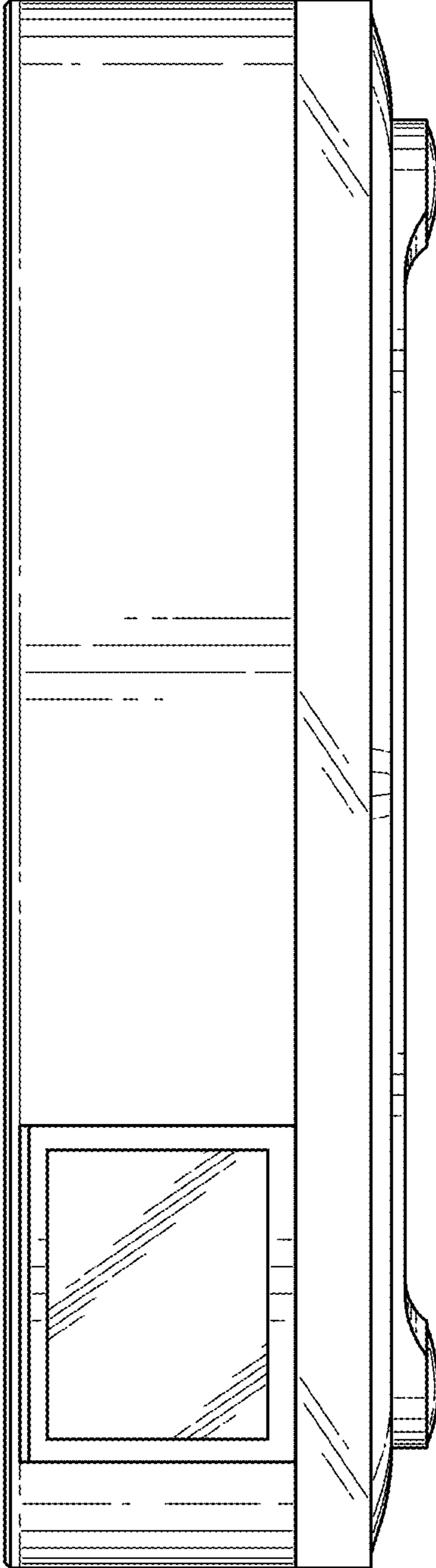

FIG. 2

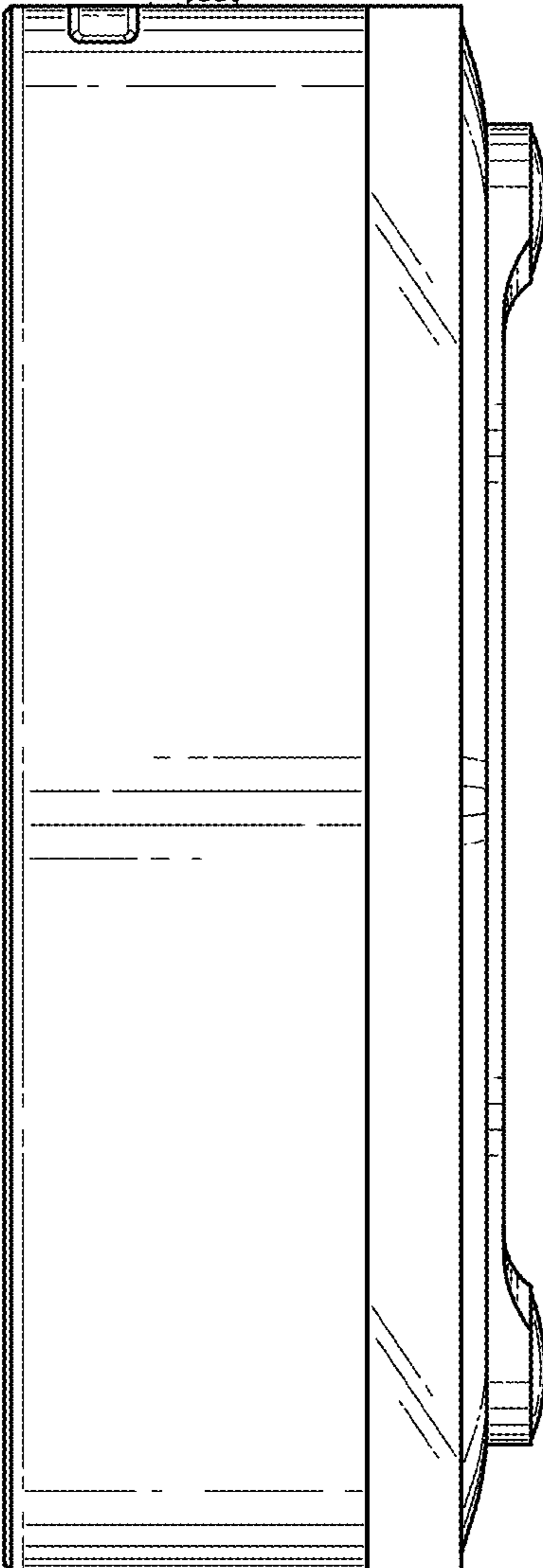

FIG. 3

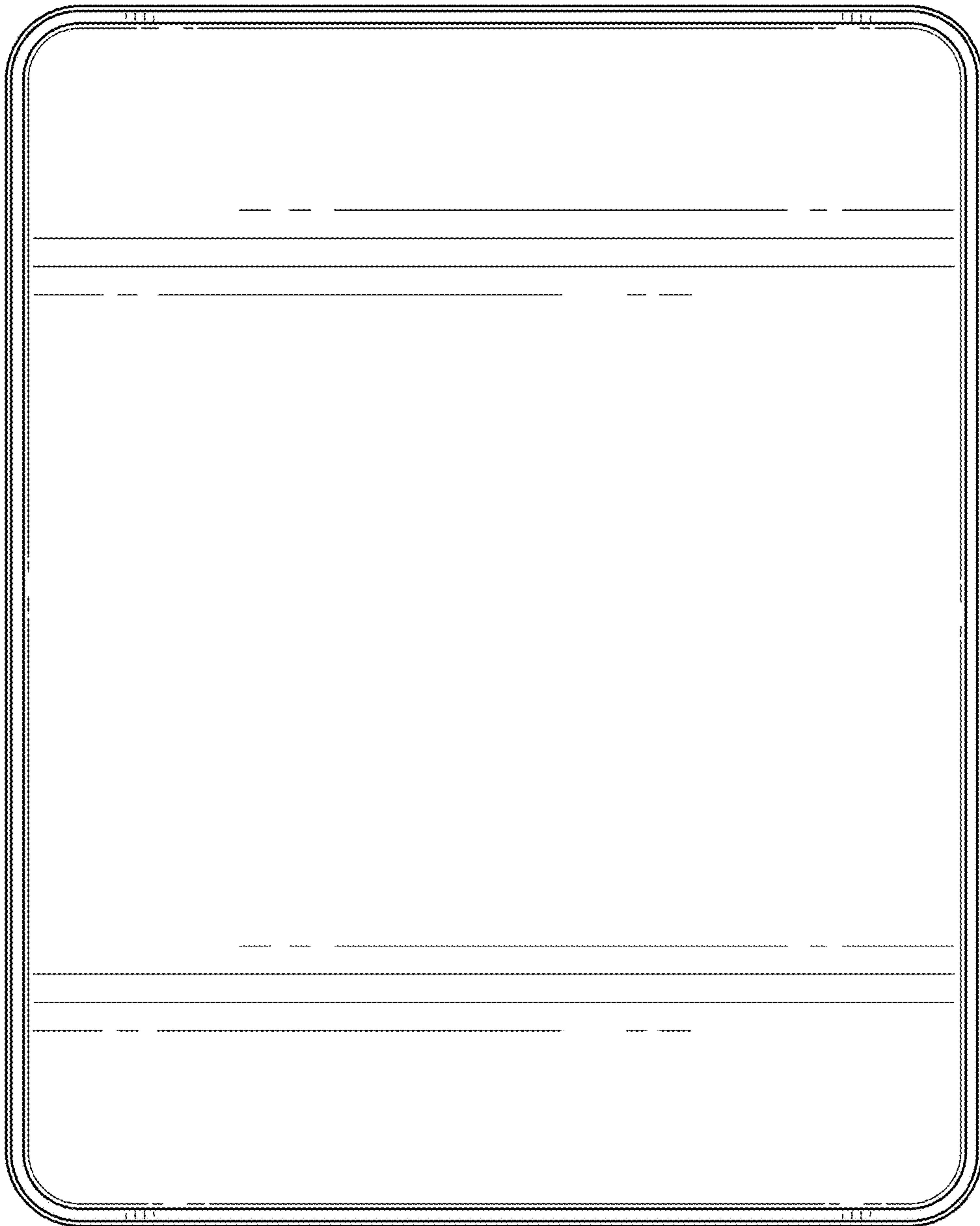

FIG. 4

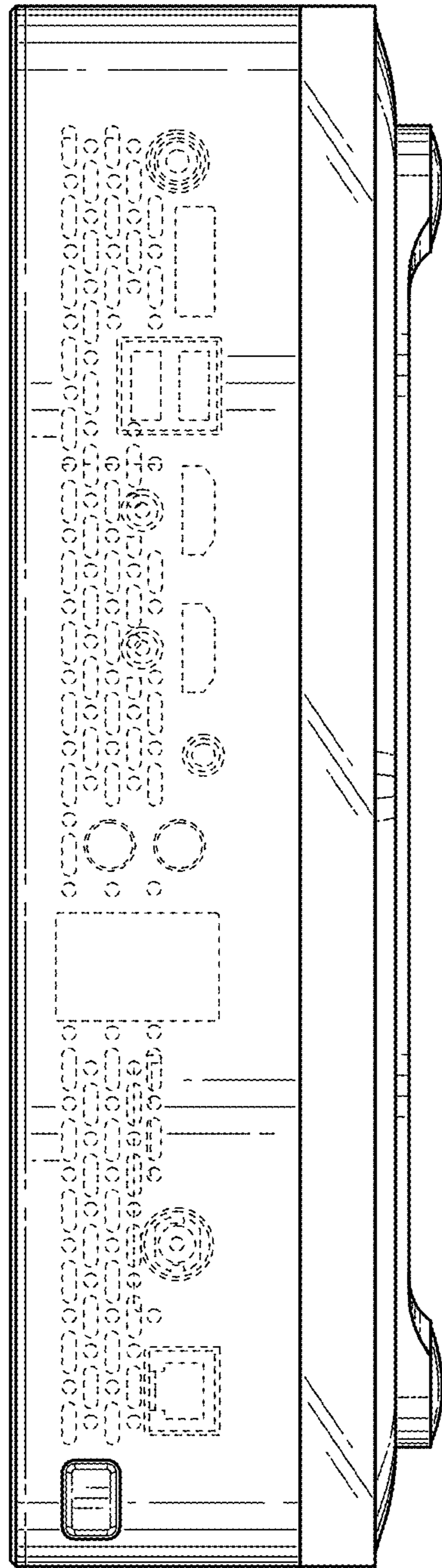

FIG. 5

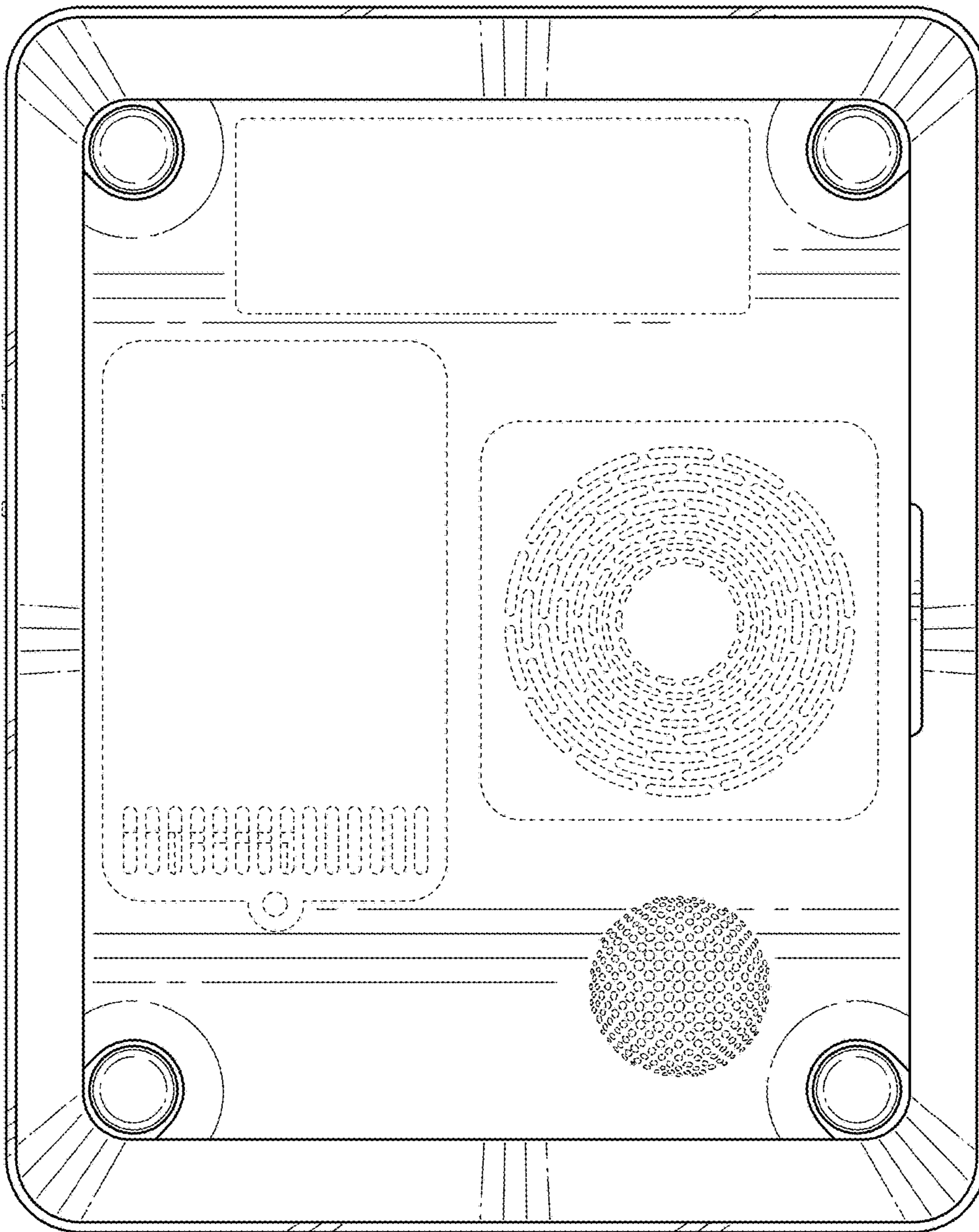

FIG. 6

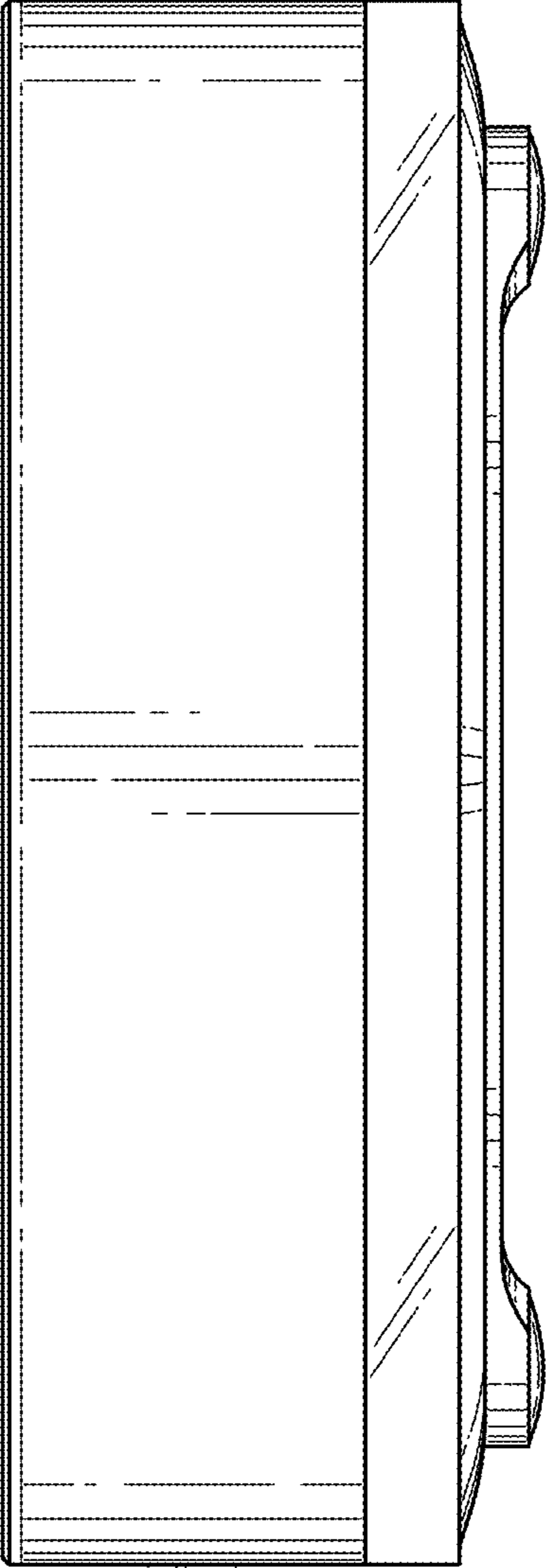

FIG. 7