



US00D777102S

(12) **United States Design Patent** (10) **Patent No.:** **US D777,102 S**
Zeine (45) **Date of Patent:** **** Jan. 24, 2017**

(54) **WIRELESS CHARGER**

(71) Applicant: **Ossia, Inc.**, Redmond, WA (US)

(72) Inventor: **Hatem Zeine**, Bellevue, WA (US)

(73) Assignee: **Ossia Inc.**, Bellevue, WA (US)

(**) Term: **14 Years**

(21) Appl. No.: **29/522,708**

(22) Filed: **Apr. 1, 2015**

(51) **LOC (10) Cl.** **13-02**

(52) **U.S. Cl.**
USPC **D13/108**

(58) **Field of Classification Search**

USPC D13/107-110, 118-119, 184; D14/251,
D14/253, 432, 434

CPC Y02E 60/12; Y02T 90/14; Y02T 90/122;
Y02T 90/128; Y02T 90/163; H02J 7/025;
H02J 7/0042; H02J 7/0044; H02J 7/0045;
H02J 7/0003; H01F 38/14; H01R
13/6675; H01M 2/1022; H01M 2/1055;
H01M 10/44; H01M 10/46; H01M
10/425; B60L 11/182

See application file for complete search history.

(56) **References Cited**

U.S. PATENT DOCUMENTS

D568,669 S * 5/2008 Kizilbayir D7/328
D590,837 S 4/2009 Dawson et al.

(Continued)

OTHER PUBLICATIONS

cm10 CircleBattery: new charging animation, posted at youtube.
com, posting date Oct. 26, 2012, © 2016 YouTube, LLC, [online],

[site visited Mar. 9, 2016]. Available from Internet, <URL: <https://www.youtube.com/watch?v=nztroKnBDPs>>.

(Continued)

Primary Examiner — Rosemary K Tarcza

Assistant Examiner — Nathaniel D Buckner

(74) *Attorney, Agent, or Firm* — Perkins Coie LLP

(57) **CLAIM**

The ornamental design for the wireless charger, as shown and described.

DESCRIPTION

FIG. 1 is a front perspective view of a wireless charger of a first embodiment of the present application; FIG. 2 is a front elevation view of the first embodiment; FIG. 3 is a back elevation view of the first embodiment; FIG. 4 is a right elevation of the first embodiment; FIG. 5 is a left elevation of the first embodiment; FIG. 6 is a top plan view of the first embodiment; FIG. 7 is a bottom plan view of the first embodiment; FIG. 8 is a front perspective view of a wireless charger of a second embodiment of the present application; FIG. 9 is a front elevation view of the second embodiment; FIG. 10 is a back elevation view of the second embodiment; FIG. 11 is a right elevation of the second embodiment; FIG. 12 is a left elevation of the second embodiment; FIG. 13 is a top plan view of the second embodiment; and, FIG. 14 is bottom plan view of the second embodiment. The broken lines in the figures represent portions of the article which form no part of the claim.

1 Claim, 12 Drawing Sheets

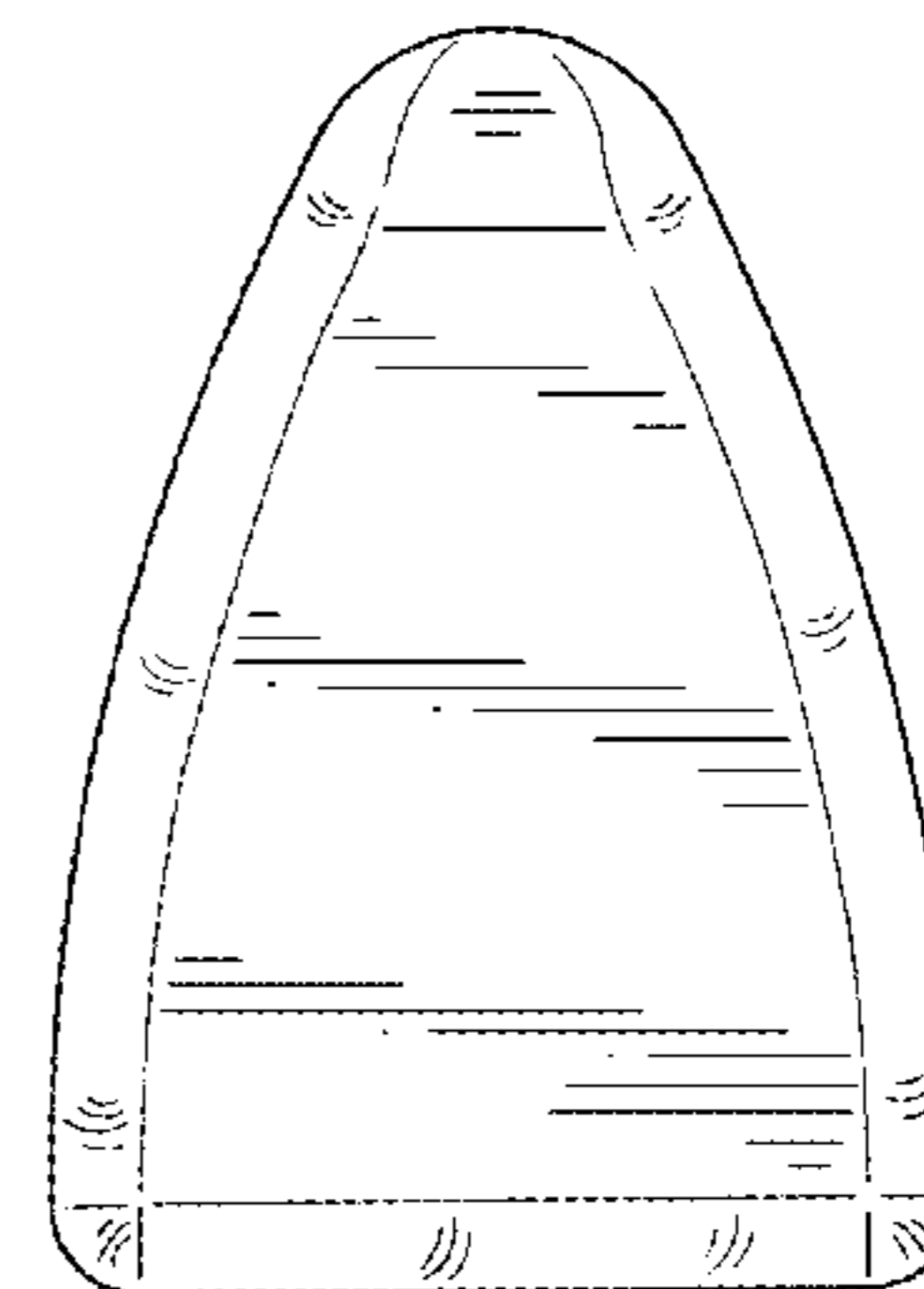
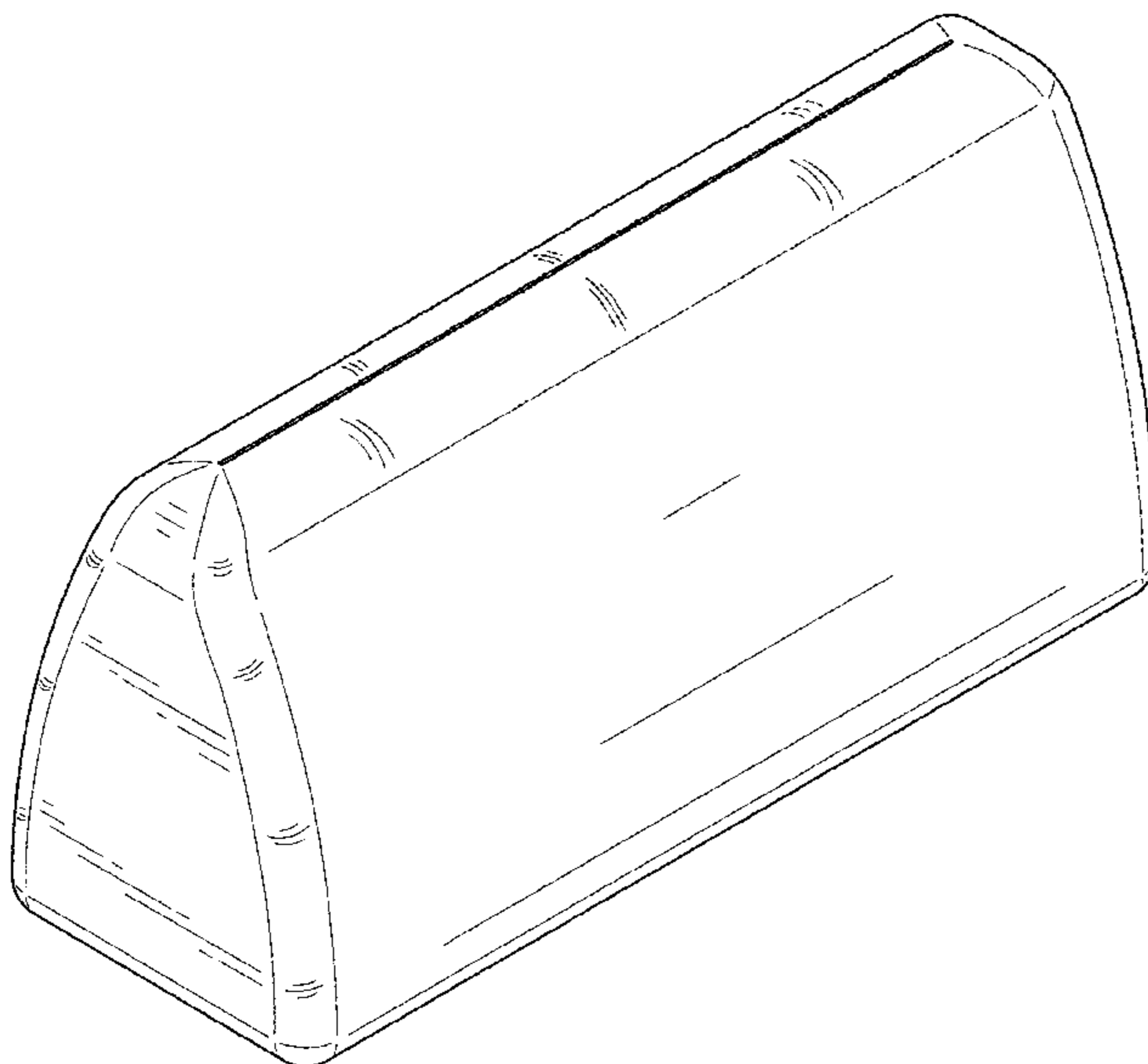

(56)

References Cited

U.S. PATENT DOCUMENTS

D606,089 S 12/2009 Lal et al.
 D614,127 S * 4/2010 Kingston D13/107
 D644,661 S 9/2011 Gardner et al.
 D650,327 S * 12/2011 Kingston D13/107
 D650,738 S * 12/2011 Leung D13/107
 D667,450 S 9/2012 Eby et al.
 D669,497 S 10/2012 Lee et al.
 D670,243 S * 11/2012 McGuire D13/110
 D676,457 S 2/2013 Frost et al.
 D678,187 S * 3/2013 Huang D13/103
 D680,952 S * 4/2013 Henderson D13/108
 D687,063 S 7/2013 Myung et al.
 D704,632 S * 5/2014 On D13/108
 D709,917 S 7/2014 Faulkner et al.
 D715,219 S * 10/2014 Cepass D13/103
 D722,018 S * 2/2015 Wang D13/103
 D723,054 S 2/2015 Nagaoka
 D727,928 S 4/2015 Allison et al.
 D730,280 S * 5/2015 Koebler D13/107
 D733,646 S * 7/2015 Spillere D13/107
 D735,132 S * 7/2015 Donohue, II D13/108
 D737,203 S * 8/2015 Shin D13/110
 D741,901 S 10/2015 Gardner et al.
 D743,333 S * 11/2015 Nomi D13/108
 D744,535 S 12/2015 Shin et al.
 D746,093 S * 12/2015 Bazzicalupo D7/330
 D746,327 S 12/2015 Varga et al.

D746,823 S * 1/2016 Lai D14/434
 D747,265 S * 1/2016 Marini D13/107
 D749,509 S * 2/2016 Blau D13/108
 2006/0224489 A1 10/2006 Pantelis et al.

OTHER PUBLICATIONS

Cota by Ossia hopes to charge your phone wirelessly, no contact required, posted at engadget.com, posting date Sep. 9, 2013, © 2016 AOL Inc, [online], [site visited Mar. 4, 2016]. Available from Internet, <URL: <http://www.engadget.com/2013/09/09/cota-by-ossia-wireless-power/>>.

Geeks on Site: "How to change what the power button does," posted at 877geekonsite.com, posting date Aug. 25, 2011, © 2012, [online], [site visited Mar. 4, 2016]. Available from Internet, <URL: <http://www.877geekonsite.com/computer-repair-blog/computer-repair/how-to-change-what-the-power-button-does/>>.

Photoshop. PSD Files: power button, posted at deviantart.com, posting date not given, © 2016 DeviantArt, [online], [site visited Mar. 4, 2016]. Available from Internet, <URL: <http://www.deviantart.com/browse/all/resources/applications/psd?q=power+button>>.

Printer power button Free Photo , posted at freepik.com, posting date not given, © 2010-2016 Graphic Resources LLC, [online], [site visited Mar. 4, 2016]. Available from Internet, <URL: http://www.freepik.com/free-photo/printer-power-button_631427.htm>.

* cited by examiner

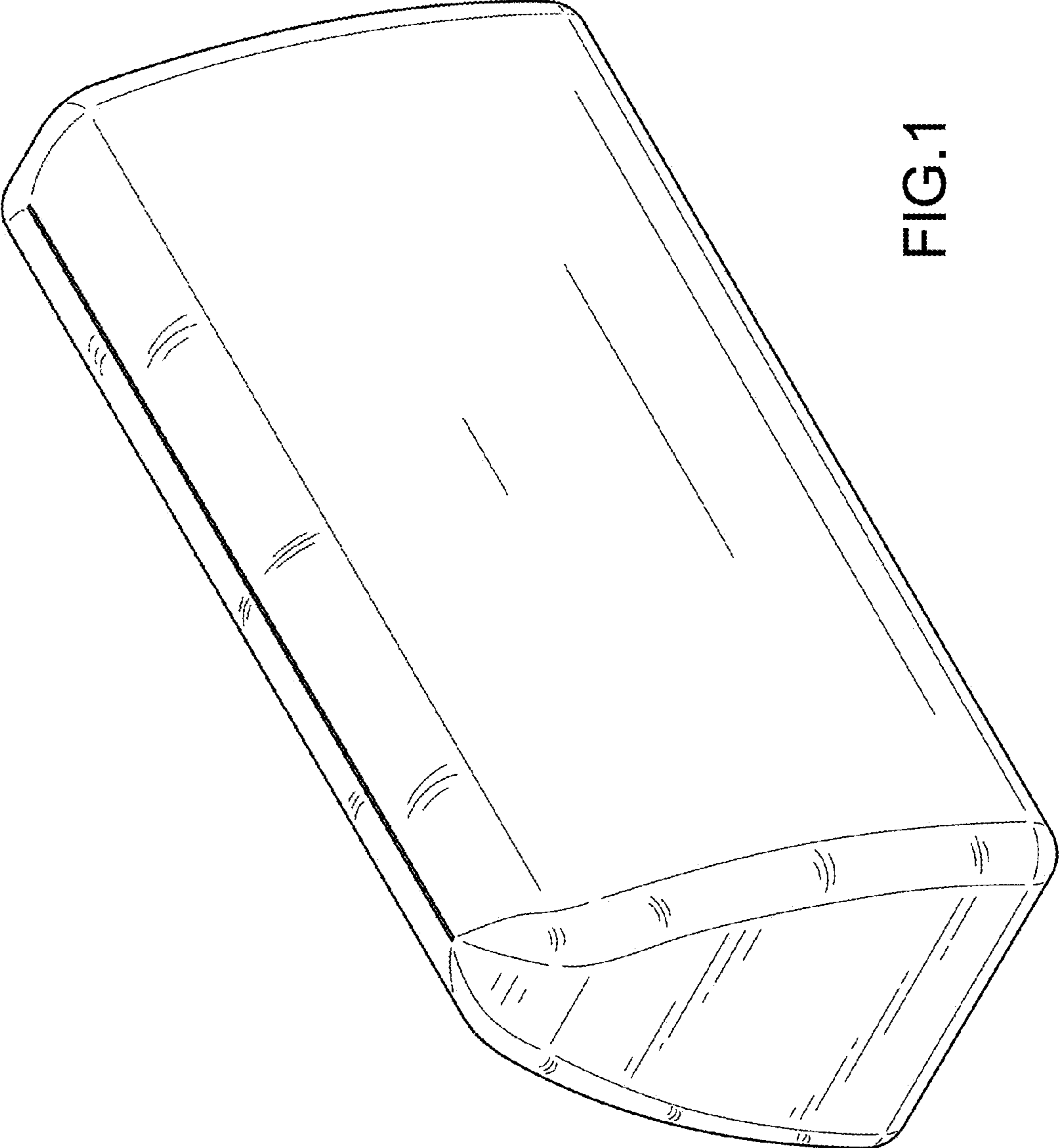

FIG. 1

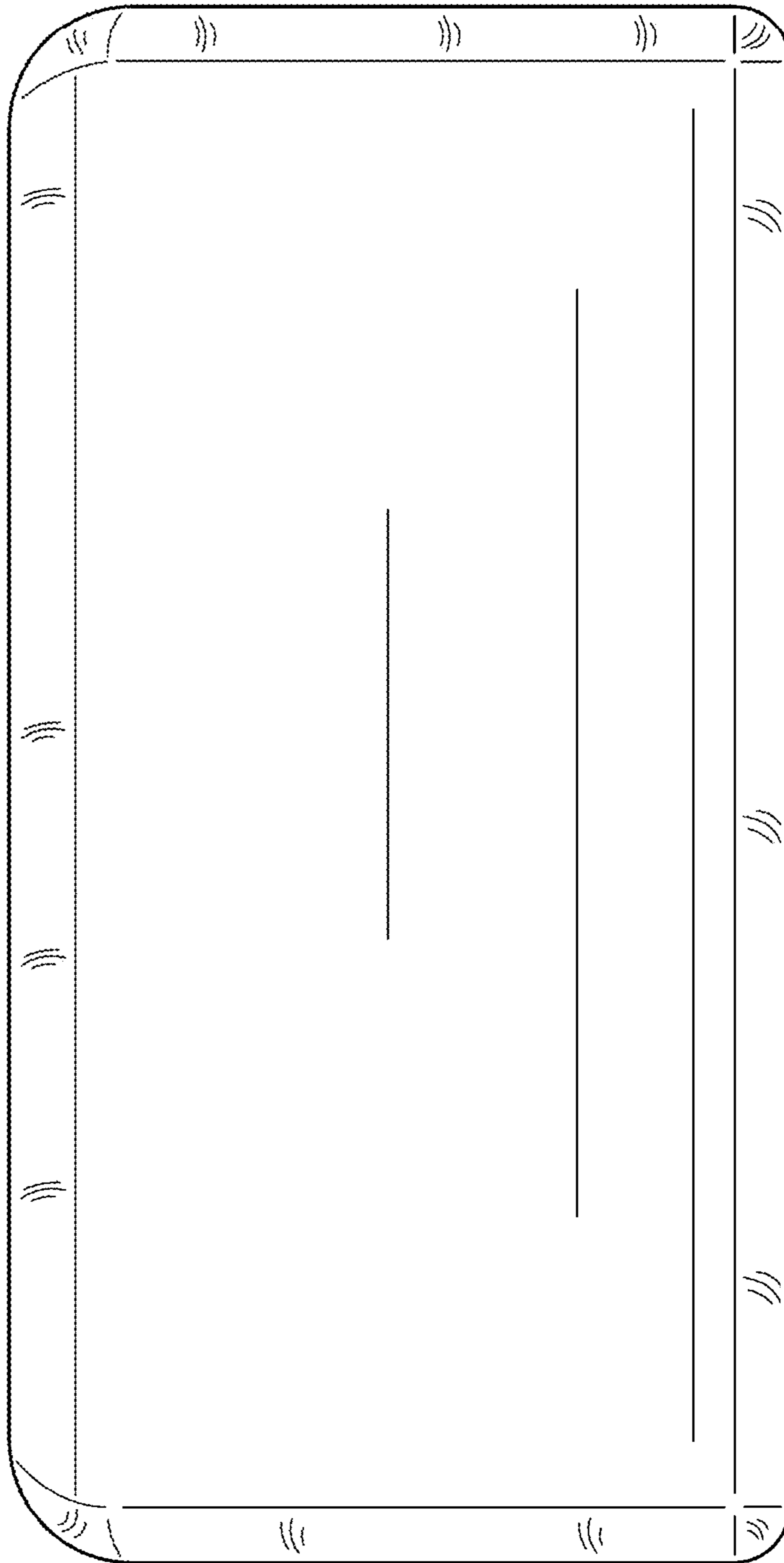

FIG. 2

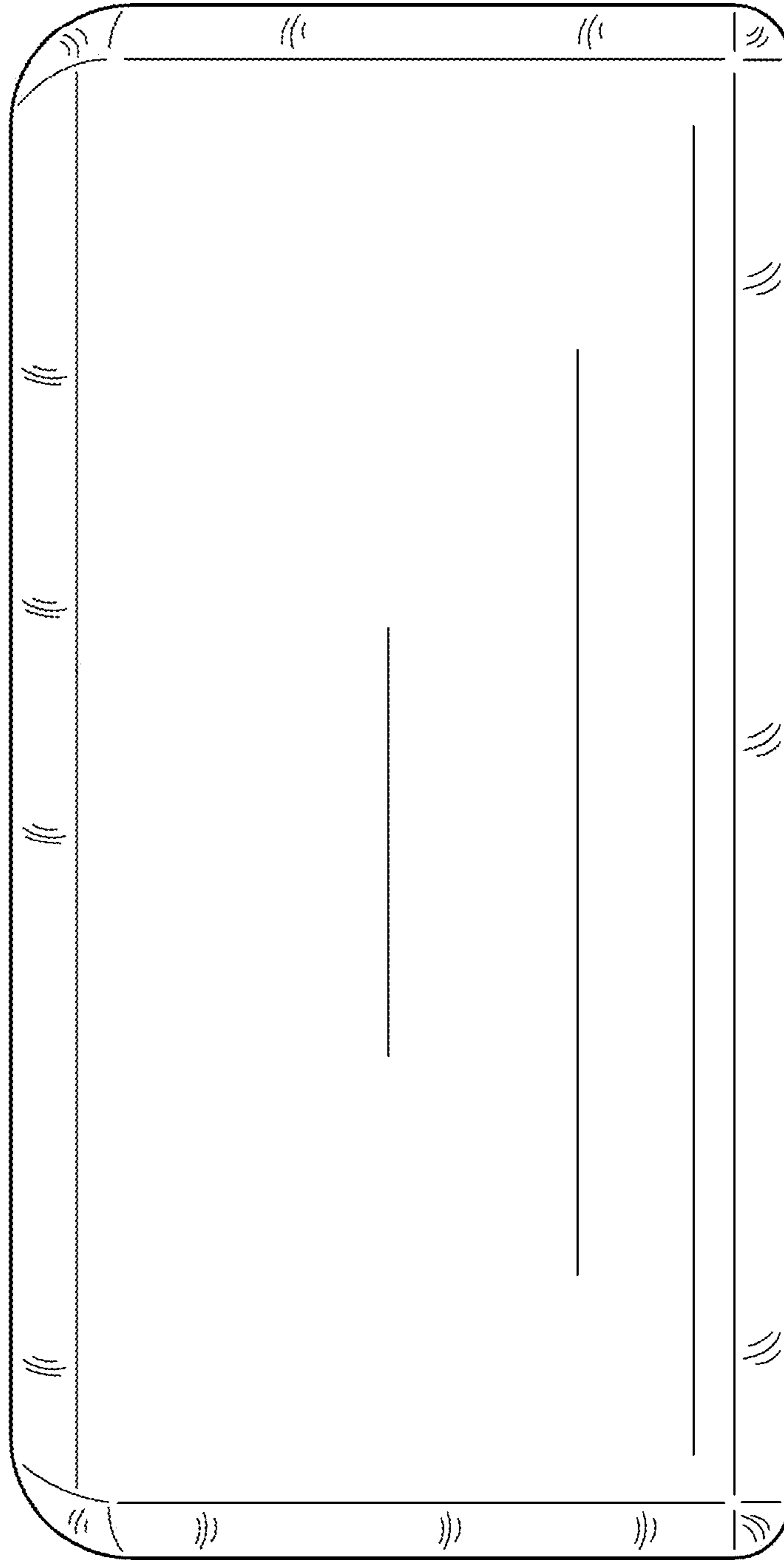

FIG. 3

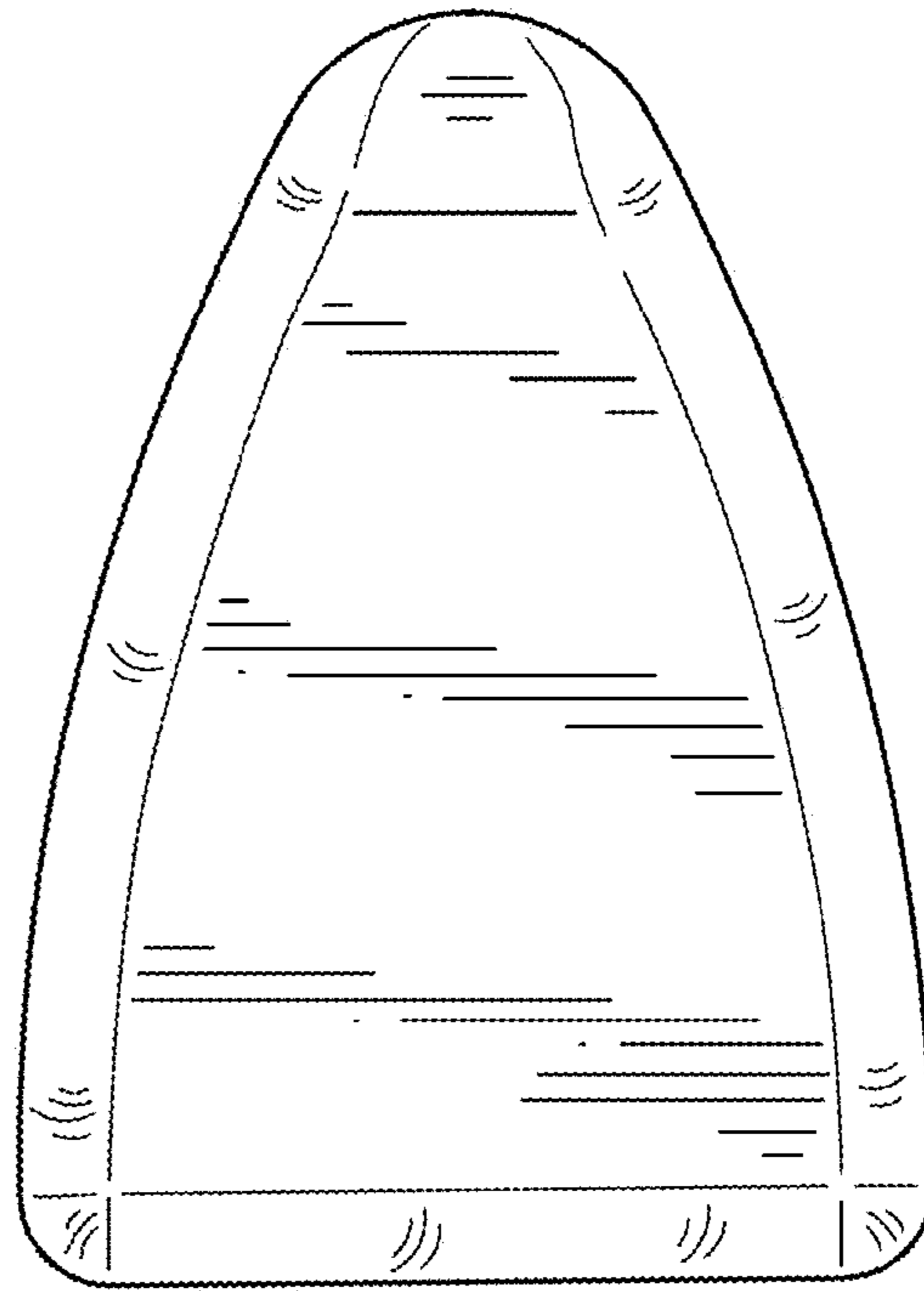

FIG. 4

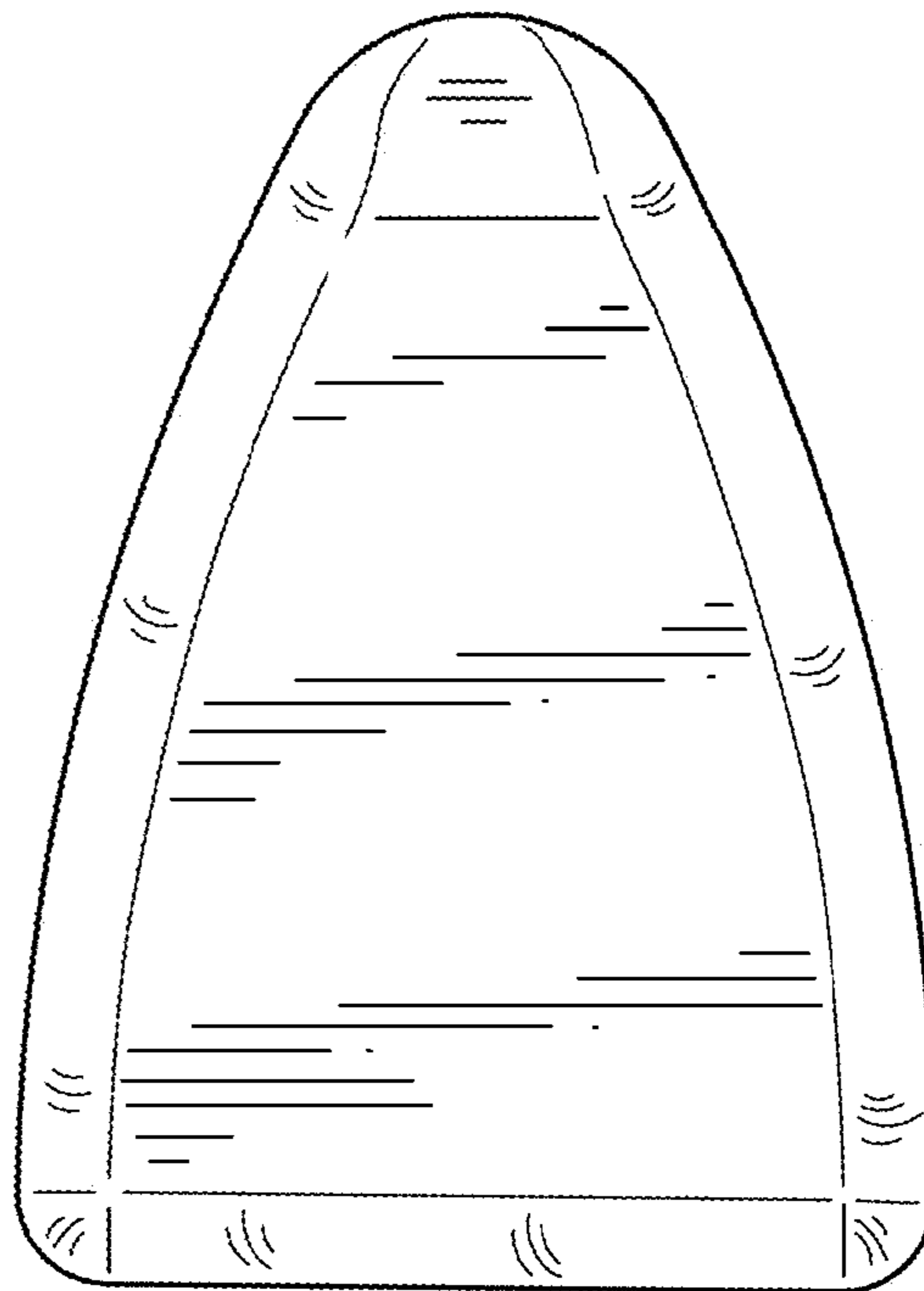

FIG. 5

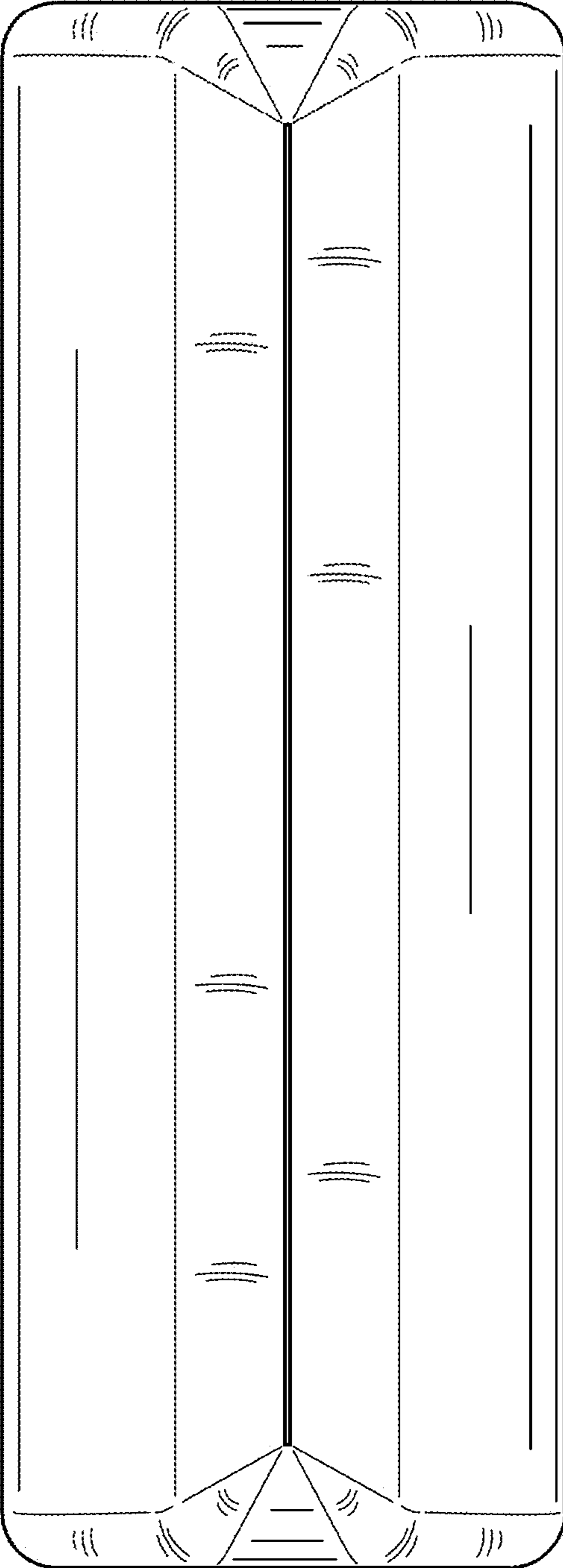

FIG. 6

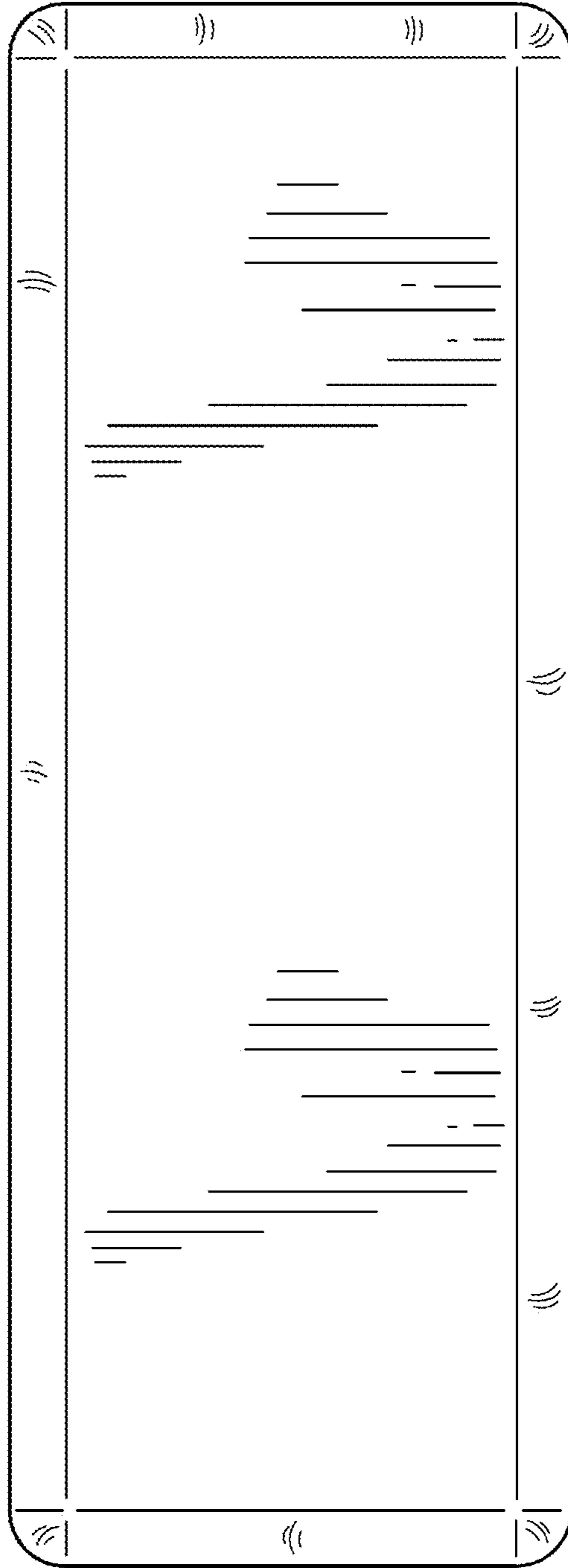

FIG. 7

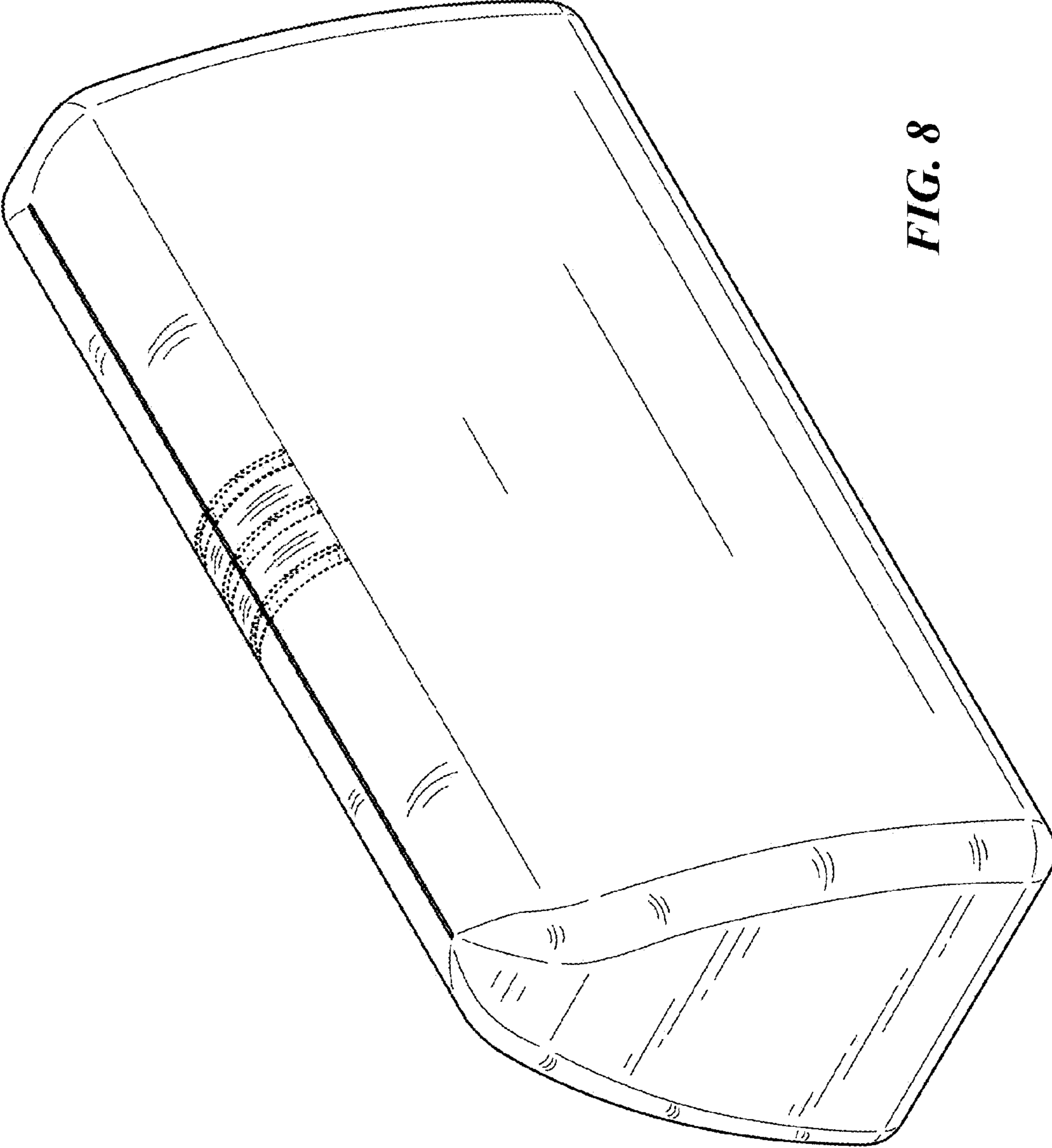

FIG. 8

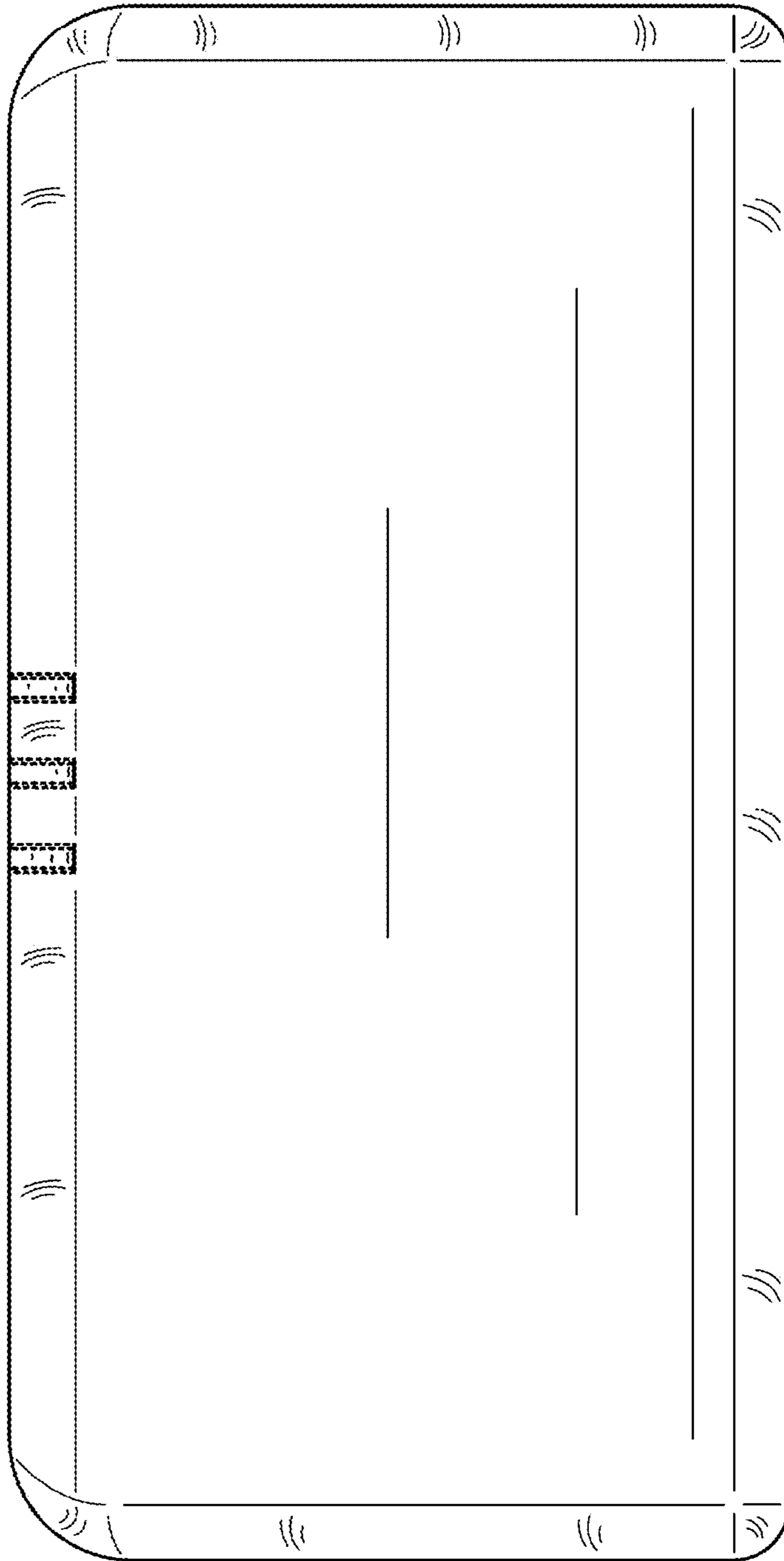

FIG. 9

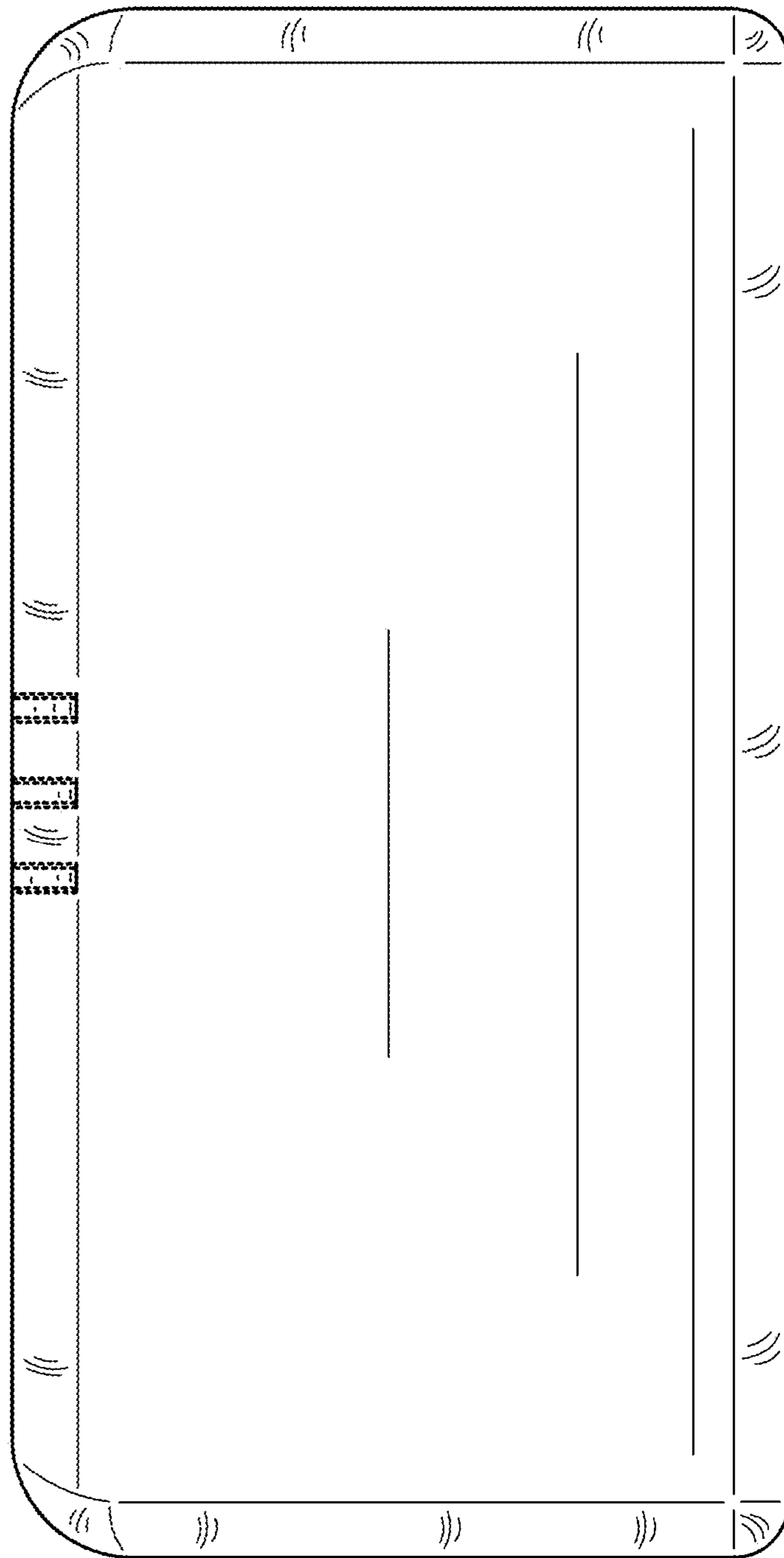

FIG. 10

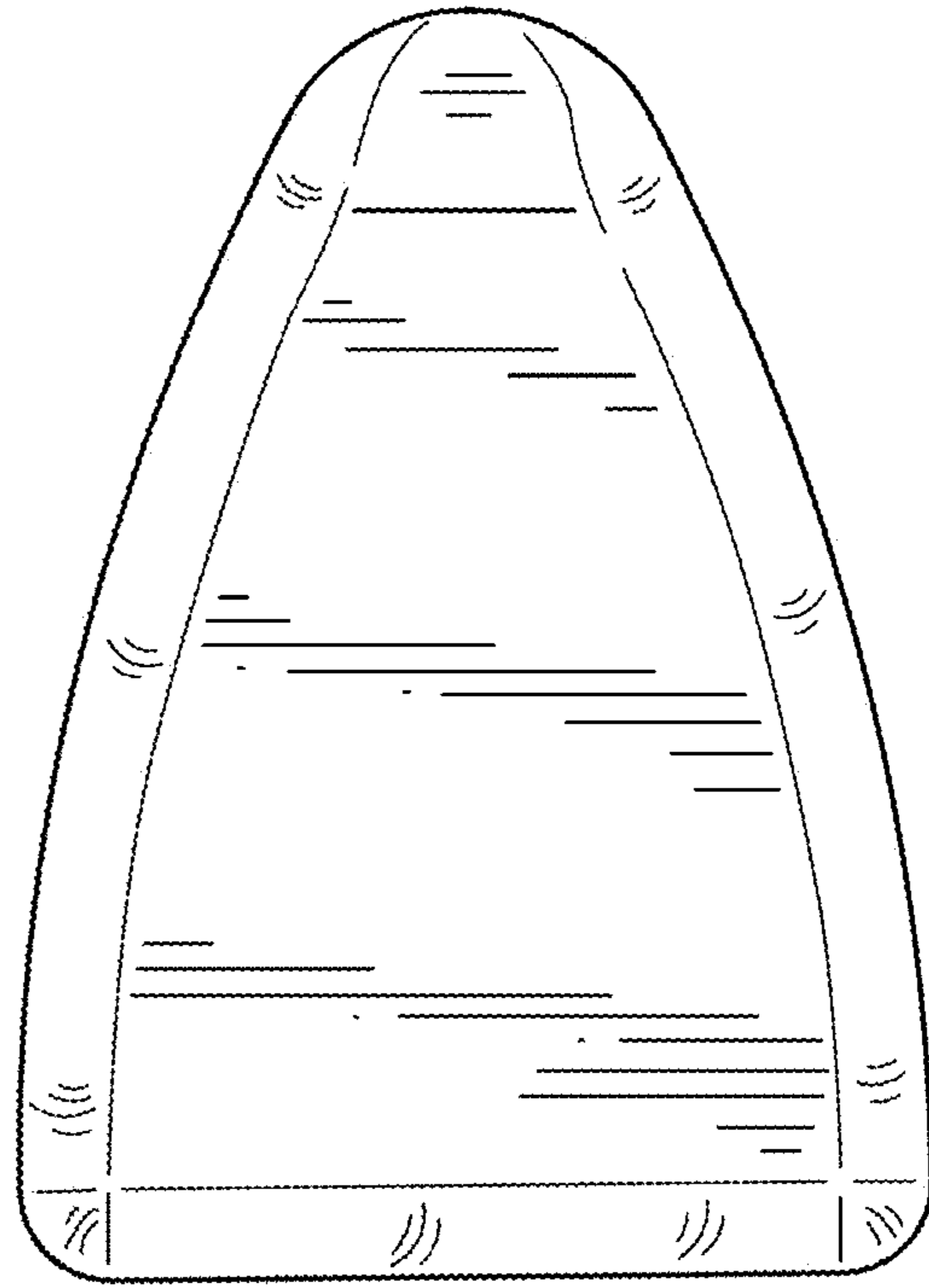

FIG. 11

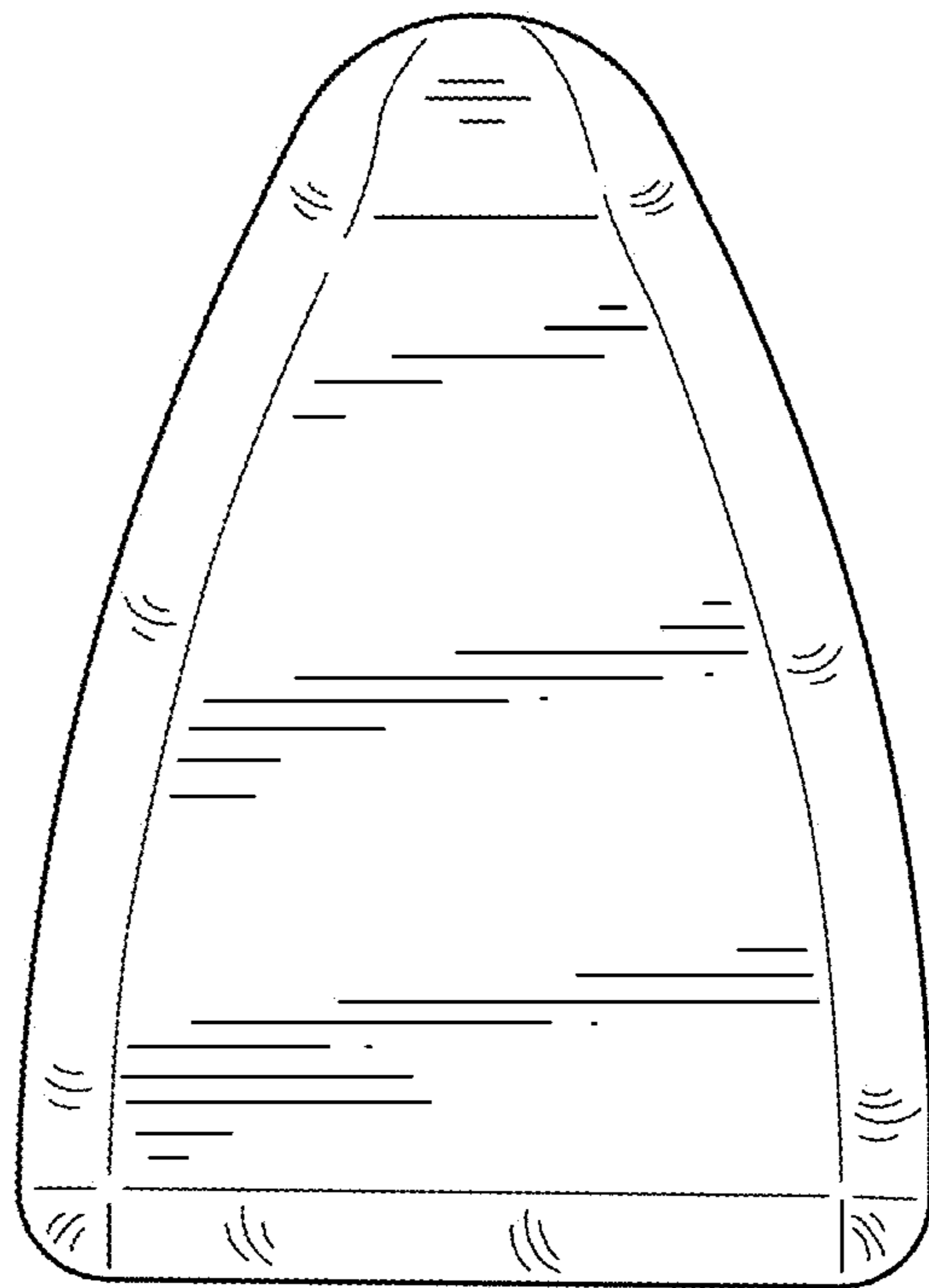

FIG. 12

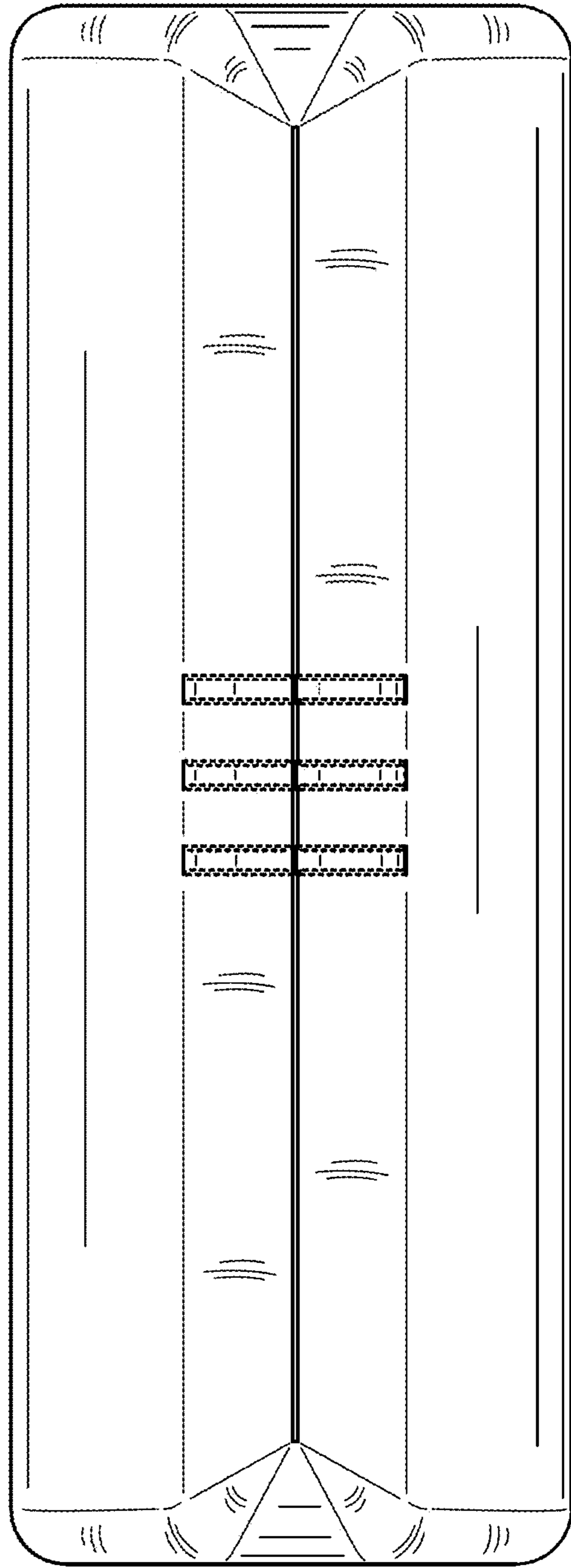

FIG. 13

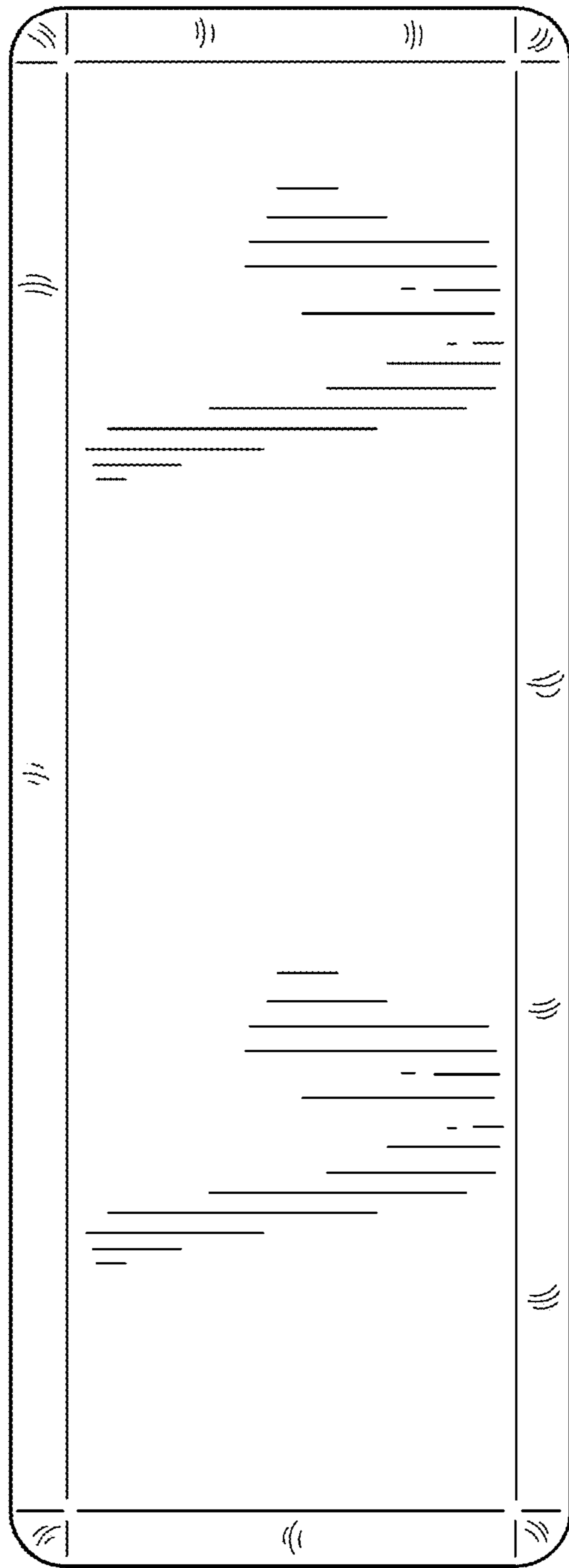

FIG. 14