



US00D777051S

(12) **United States Design Patent** (10) **Patent No.:** **US D777,051 S**
Cotsman (45) **Date of Patent:** **** Jan. 24, 2017**

(54) **SIGNALING FLARE**
 (71) Applicant: **Adam Cotsman**, Ottawa (CA)
 (72) Inventor: **Adam Cotsman**, Ottawa (CA)
 (**) Term: **14 Years**

6,371,625 B2 * 4/2002 Campman 362/102
 D521,168 S * 5/2006 Waters D10/114.1
 D574,741 S * 8/2008 Gadsden D10/114.9
 D625,861 S * 10/2010 Bertken D10/114.9
 D626,671 S * 11/2010 Bertken D10/114.9
 D740,149 S * 10/2015 Talamo D10/114.9
 2001/0015893 A1 * 8/2001 Campman F21L 4/02
 362/184

(21) Appl. No.: **29/497,720**
 (22) Filed: **Jul. 28, 2014**

* cited by examiner

Primary Examiner — George D Kirschbaum
 (74) *Attorney, Agent, or Firm* — Greer, Burns & Crain, Ltd.

(30) **Foreign Application Priority Data**

Jan. 28, 2014 (CA) 154806

(51) **LOC (10) Cl.** **10-05**
 (52) **U.S. Cl.**
 USPC **D10/114.9**

(57) **CLAIM**

The ornamental design for a signaling flare, as shown and described.

(58) **Field of Classification Search**
 USPC D10/114.9, 114.1; D26/41, 37
 CPC F21L 4/02
 See application file for complete search history.

DESCRIPTION

FIG. 1 is a first perspective view of the signaling flare according to a first variant;
 FIG. 2 is a second perspective view of the signaling flare according to the first variant of FIG. 1;
 FIG. 3 is a left side view of the signaling flare according to the first variant of FIG. 1;
 FIG. 4 is a right side view of the signaling flare according to the first variant of FIG. 1;
 FIG. 5 is a top view of the signaling flare according to the first variant of FIG. 1;
 FIG. 6 is a bottom view of the signaling flare according to the first variant of FIG. 1;
 FIG. 7 is a front view of the signaling flare according to the first variant of FIG. 1; and,
 FIG. 8 is a rear view of the signaling flare according to the first variant of FIG. 1.

(56) **References Cited**

U.S. PATENT DOCUMENTS

D274,317 S * 6/1984 Nelson D10/114.9
 5,079,679 A * 1/1992 Chin-Fa F21L 4/02
 362/102
 5,081,568 A * 1/1992 Dong F21L 4/02
 340/321
 D325,002 S * 3/1992 Brau D10/114.9
 5,622,423 A * 4/1997 Lee F21L 4/02
 362/102
 D389,420 S * 1/1998 Campman D10/114.9
 6,213,623 B1 * 4/2001 Campman F21L 4/02
 362/184
 D448,102 S * 9/2001 Campman D26/41

1 Claim, 5 Drawing Sheets

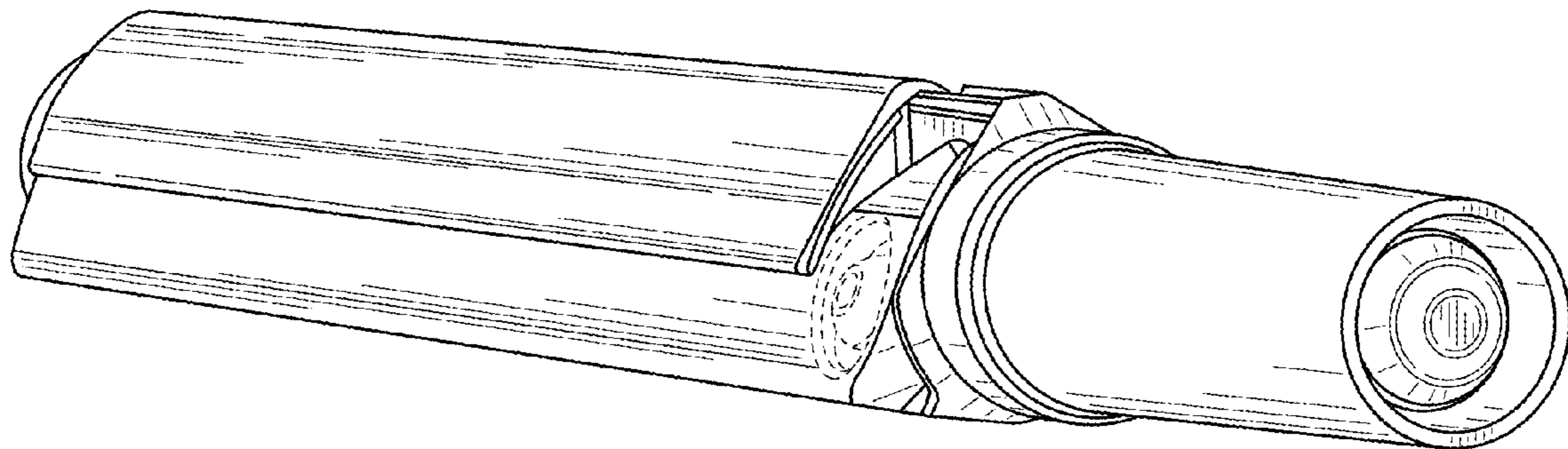

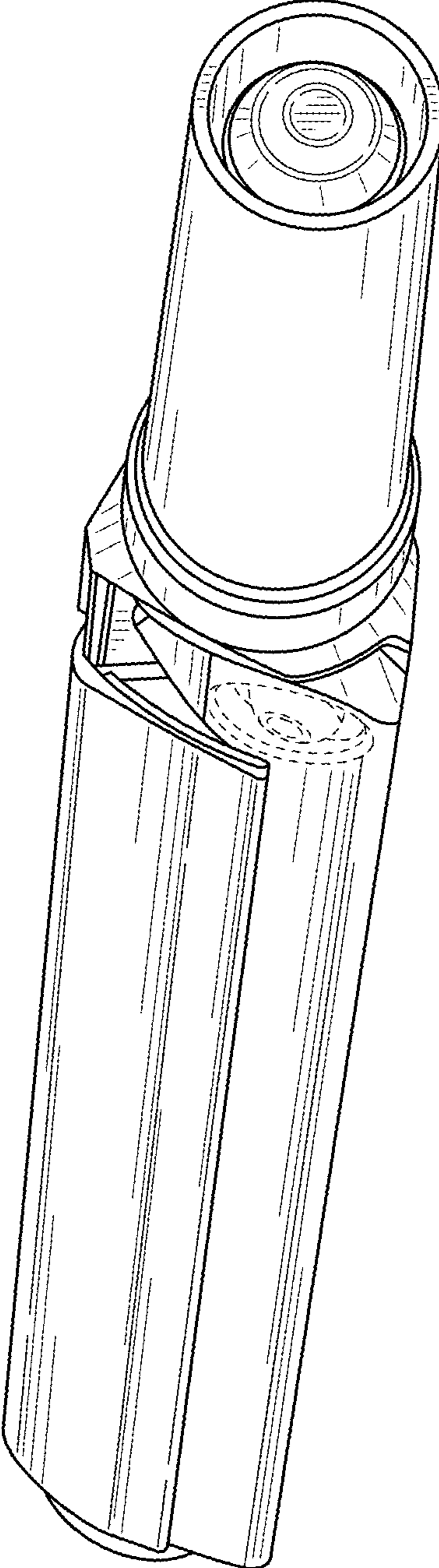

FIG. 1

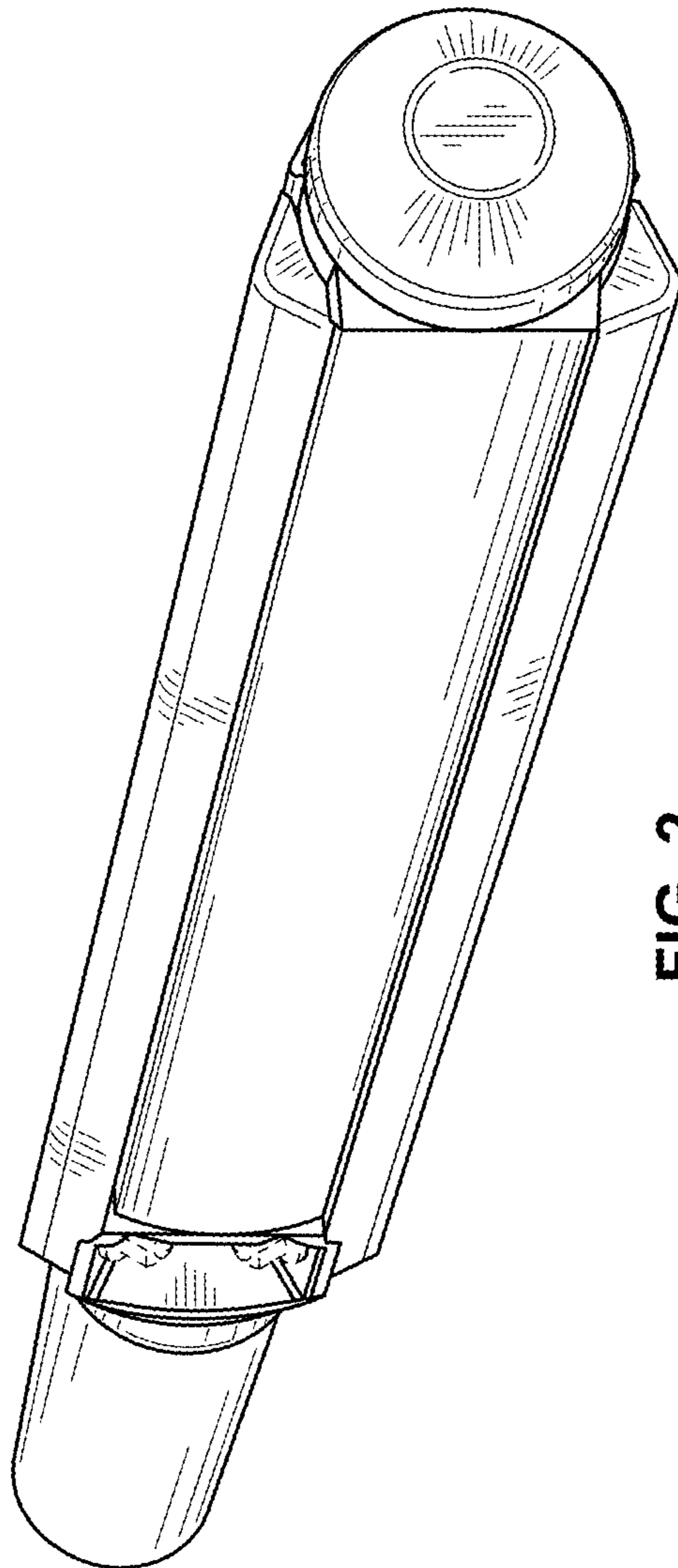

FIG. 2

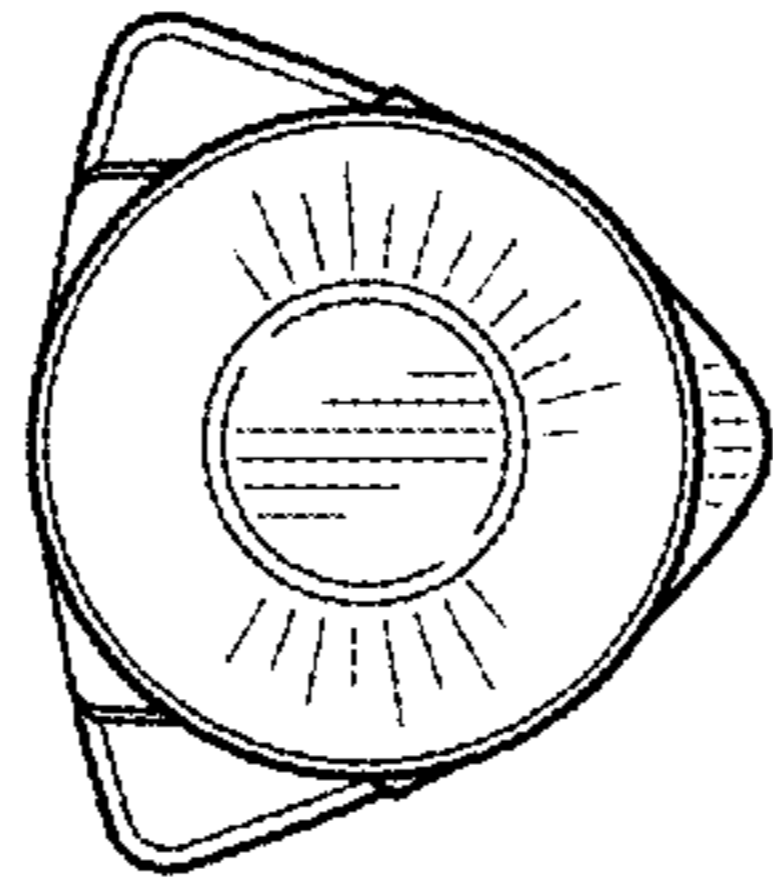

FIG. 4

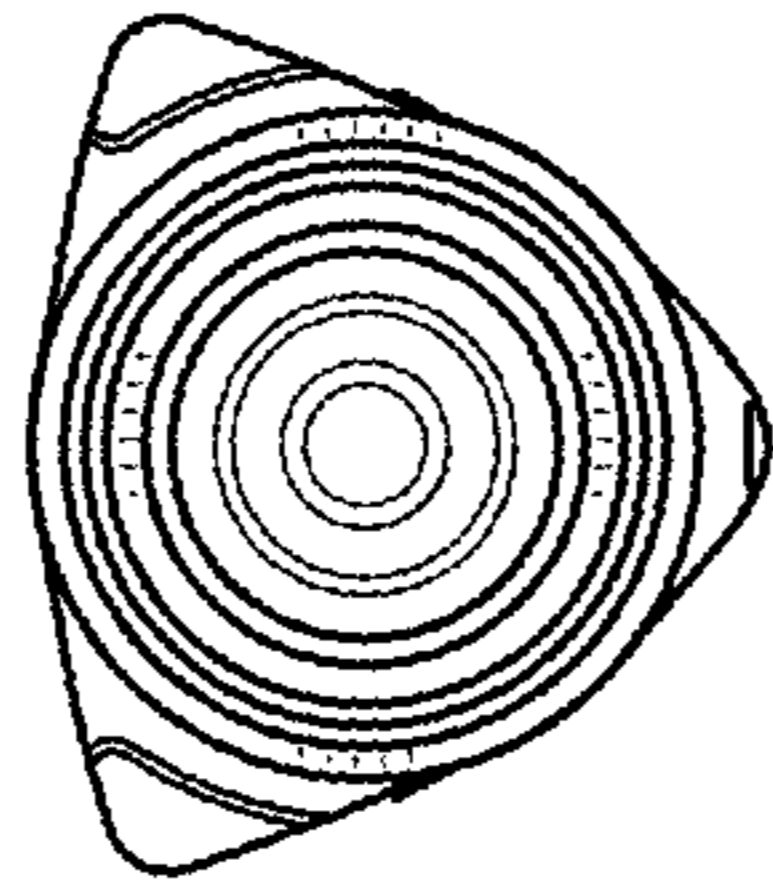

FIG. 3

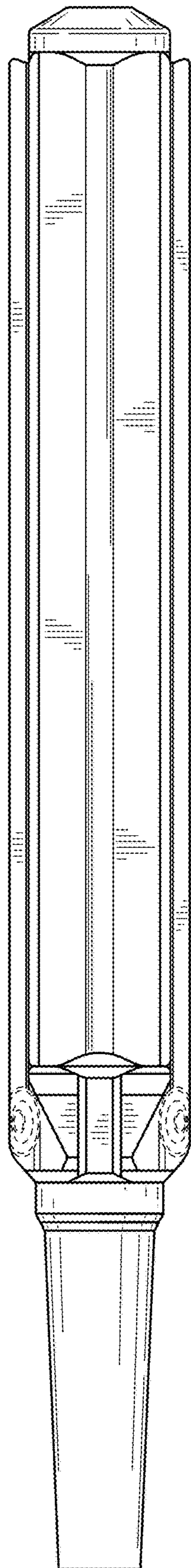

FIG. 5

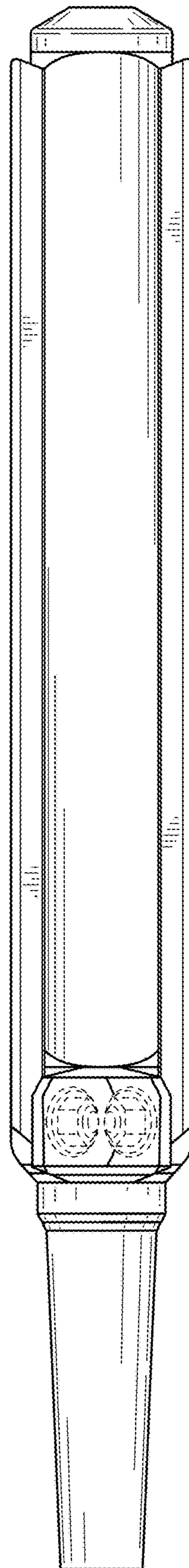

FIG. 6

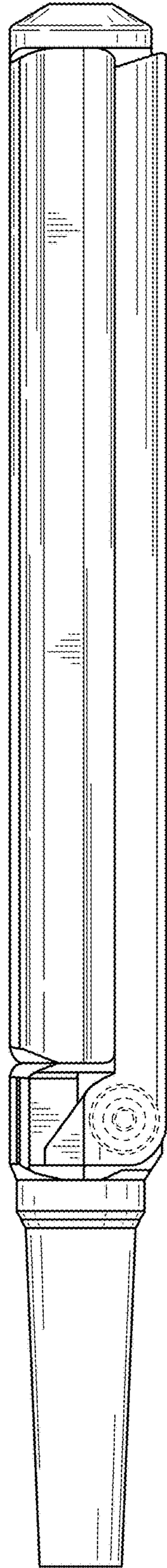

FIG. 7

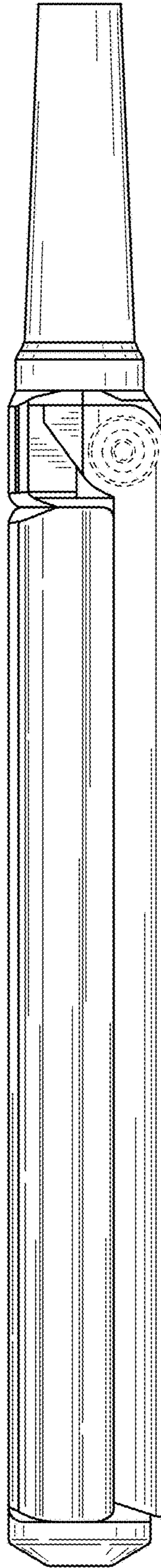

FIG. 8