



US00D776960S

(12) **United States Design Patent** (10) **Patent No.:** **US D776,960 S**  
**Suzuki et al.** (45) **Date of Patent:** **\*\* Jan. 24, 2017**

(54) **MATTRESS**  
(71) Applicant: **Casper Sleep Inc.**, New York, NY (US)  
(72) Inventors: **Gen Suzuki**, Kanagawa (JP); **Jeffrey Chapin**, Providence, RI (US); **Neil Parikh**, Toms River, NJ (US)  
(73) Assignee: **CASPER SLEEP INC.**, New York, NY (US)  
(\*\*) Term: **14 Years**  
(21) Appl. No.: **29/524,231**  
(22) Filed: **Apr. 17, 2015**  
(51) **LOC (10) Cl.** ..... **06-09**  
(52) **U.S. Cl.**  
USPC ..... **D6/605**  
(58) **Field of Classification Search**  
USPC ..... D6/582-583, 587-592, 595-609,  
D6/617-622; D21/803-809; D24/183  
(Continued)

(56) **References Cited**  
U.S. PATENT DOCUMENTS  
4,962,546 A \* 10/1990 Vitale ..... D04H 13/003  
5/497  
5,809,593 A \* 9/1998 Edwards ..... A47G 9/0246  
40/299.01  
(Continued)

*Primary Examiner* — Mary Ann Calabrese  
*Assistant Examiner* — Jennifer L Rempfer  
(74) *Attorney, Agent, or Firm* — Wilson, Sonsini,  
Goodrich & Rosati

(57) **CLAIM**  
The ornamental design for a mattress, as shown and described.

**DESCRIPTION**

FIG. 1 is a top front perspective view of a first embodiment of a twin size mattress showing our new design;

FIG. 2 is a front elevational view thereof (back elevational view is identical);  
FIG. 3 is a left side elevational view thereof;  
FIG. 4 is a right side elevational view thereof;  
FIG. 5 is a top plan view thereof;  
FIG. 6 is a bottom plan view thereof;  
FIG. 7 is a top front perspective view of an alternate embodiment of a twin XL size mattress, showing our new design;  
FIG. 8 is a front elevational view thereof (back elevational view is identical);  
FIG. 9 is a left side elevational view thereof;  
FIG. 10 is a right side elevational view thereof;  
FIG. 11 is a top plan view thereof;  
FIG. 12 is a bottom plan view thereof;  
FIG. 13 is a top front perspective view of an alternate embodiment of a full size mattress, showing our new design;  
FIG. 14 is a front elevational view thereof (back elevational view is identical);  
FIG. 15 is a left side elevational view thereof;  
FIG. 16 is a right side elevational view thereof;  
FIG. 17 is a top plan view thereof;  
FIG. 18 is a bottom plan view thereof;  
FIG. 19 is a top front perspective view of an alternate embodiment of a queen size mattress, showing our new design;  
FIG. 20 is a front elevational view thereof (back elevational view is identical);  
FIG. 21 is a left side elevational view thereof;  
FIG. 22 is a right side elevational view thereof;  
FIG. 23 is a top plan view thereof;  
FIG. 24 is a bottom plan view thereof;  
FIG. 25 is a top front perspective view of an alternate embodiment of a king size mattress, showing our new design;  
FIG. 26 is a front elevational view thereof (back elevational view is identical);  
FIG. 27 is a left side elevational view thereof;  
FIG. 28 is a right side elevational view thereof;  
FIG. 29 is a top plan view thereof;  
FIG. 30 is a bottom plan view thereof;  
FIG. 31 is a top front perspective view of an alternate embodiment of a California king size mattress, showing our new design;

(Continued)

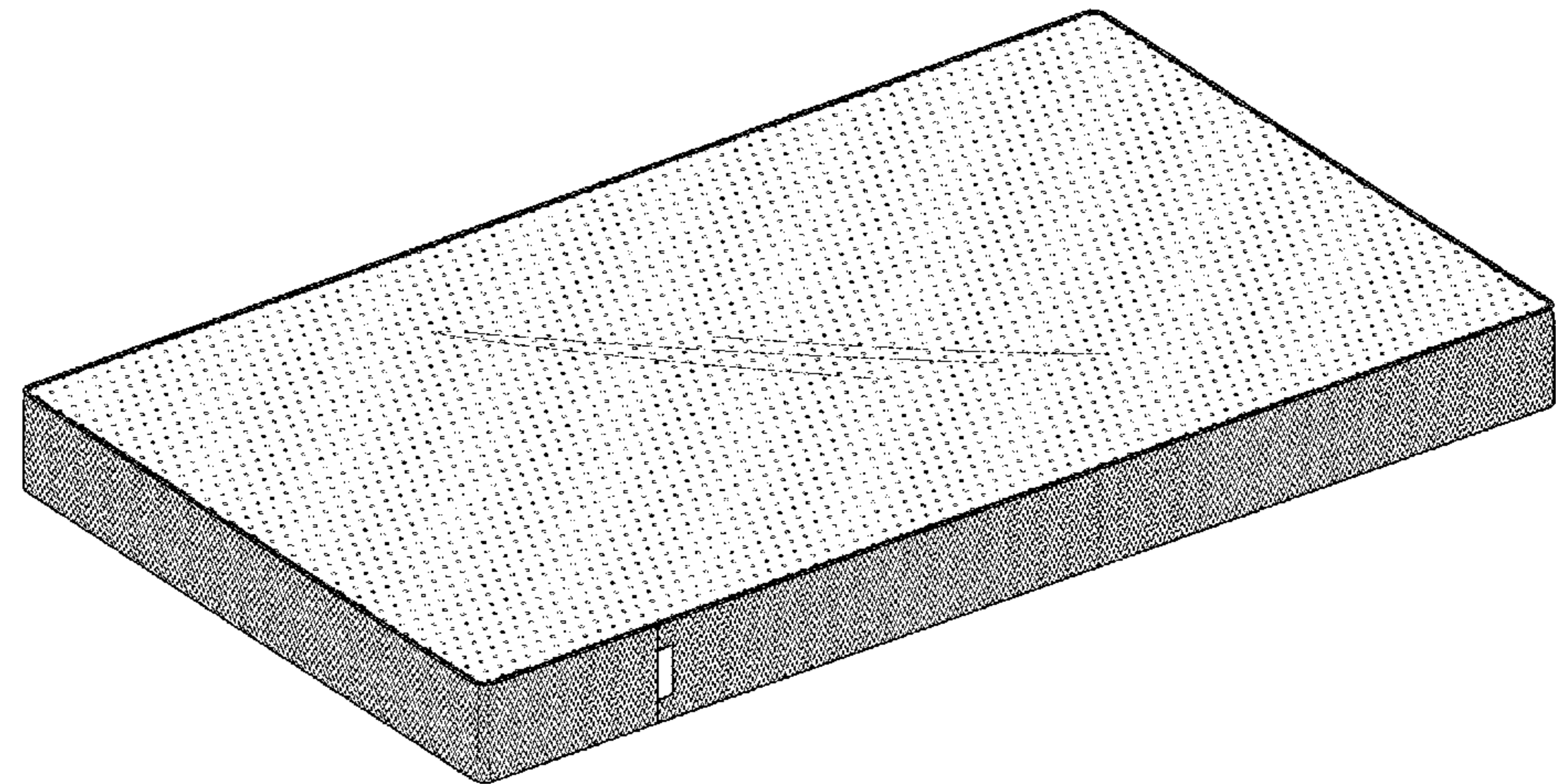

FIG. 32 is a front elevational view thereof (back elevational view is identical);  
 FIG. 33 is a left side elevational view thereof;  
 FIG. 34 is a right side elevational view thereof;  
 FIG. 35 is a top plan view thereof; and,  
 FIG. 36 is a bottom plan view thereof.  
 Pattern on top surface is intended to show dimpled pattern on mattress and pattern on side surfaces is intended to show fabric texture and pattern.

**1 Claim, 24 Drawing Sheets**

(58) **Field of Classification Search**

CPC ..... A47G 9/00; A47G 2009/001; A47G 2009/002; A47G 2009/003; A47G 2009/005; A47G 2009/006; A47G 9/02; A47G 9/0207; A47G 9/0215; A47G 9/0223; A47G 9/023; A47G 9/0238; A47G 9/0246; A47G 9/0253; A47G 9/0261; A47G 9/06; A47G 9/062; A47G 9/066; A47G 9/068; A47G 9/08; A47G 2009/0276; A47G 9/0284; A47G 9/0292; A47G 9/04; A47G 9/10

See application file for complete search history.

(56) **References Cited**

U.S. PATENT DOCUMENTS

6,360,390 B1 \* 3/2002 Bonaddio ..... A47C 27/053 5/717  
 6,393,640 B1 \* 5/2002 Dalis ..... A47C 27/005 5/497  
 D488,661 S \* 4/2004 Barman ..... D6/596  
 7,334,280 B1 \* 2/2008 Swartzburg ..... A47C 21/046 5/652.1  
  
 D616,236 S 5/2010 Morrison  
 D621,197 S 8/2010 Gladney et al.  
 D622,088 S 8/2010 Morrison  
 D622,531 S 8/2010 Morrison et al.  
 D622,996 S 9/2010 Morrison et al.  
 D633,322 S 3/2011 Morrison  
 D634,148 S 3/2011 Morrison  
 D640,082 S 6/2011 Morrison  
 D642,847 S 8/2011 Rinehart  
 D649,385 S 11/2011 Freese et al.  
 D649,386 S 11/2011 Freese et al.  
 D649,387 S 11/2011 Jung et al.  
 D651,443 S 1/2012 Wightman  
 D659,459 S 5/2012 Jung et al.  
 D662,751 S 7/2012 Morrison et al.  
 D662,752 S 7/2012 Morrison et al.  
 D662,753 S 7/2012 Shive  
 D662,754 S 7/2012 Shive

D663,152 S 7/2012 Shive  
 D666,448 S 9/2012 Morrison et al.  
 D666,449 S 9/2012 Morrison et al.  
 D667,671 S 9/2012 Rinehart  
 D669,726 S 10/2012 Wightman  
 D670,126 S 11/2012 Price  
 D673,411 S 1/2013 Roberts et al.  
 D673,412 S 1/2013 Roberts et al.  
 D674,229 S 1/2013 Roberts et al.  
 D679,931 S 4/2013 Itzkovitz  
 D683,992 S \* 6/2013 Gladney ..... D6/605  
 D688,491 S 8/2013 Wightman  
 D690,134 S 9/2013 Nielsen et al.  
 D690,538 S 10/2013 Nielsen et al.  
 D690,962 S 10/2013 Danileson  
 D691,399 S \* 10/2013 Jalan ..... D6/602  
 D691,831 S 10/2013 Jorgensen et al.  
 D693,143 S 11/2013 Nielsen et al.  
 D693,604 S 11/2013 Asklof  
 D696,048 S 12/2013 Morrison  
 D696,530 S 12/2013 Bradford  
 D701,712 S 4/2014 Nielsen et al.  
 D703,977 S 5/2014 Roberts et al.  
 D704,477 S 5/2014 Jorgensen et al.  
 D704,478 S 5/2014 Arnold  
 D704,964 S 5/2014 Gatto et al.  
 D704,965 S 5/2014 Arnold  
 D705,580 S 5/2014 Jorgensen et al.  
 D707,060 S \* 6/2014 Tjoflat ..... D6/605  
 D707,061 S 6/2014 Tjoflat  
 D707,469 S 6/2014 Wightman  
 D707,983 S 7/2014 Hughes  
 D707,986 S 7/2014 Arnold  
 D711,160 S 8/2014 Arnold  
 D713,175 S 9/2014 Roberts et al.  
 D715,075 S 10/2014 Hughes  
 D717,077 S 11/2014 Arnold  
 D717,078 S 11/2014 Arnold  
 D717,079 S 11/2014 Bradford  
 D731,820 S \* 6/2015 Lechantre ..... D6/605  
 D737,076 S \* 8/2015 Wightman ..... D6/605  
 D744,768 S \* 12/2015 Morrison ..... D6/605  
 D746,083 S \* 12/2015 Jensen ..... D6/606  
 D746,085 S \* 12/2015 Jensen ..... D6/606  
 D753,935 S \* 4/2016 Driffield ..... D6/606  
 2003/0019043 A1 \* 1/2003 Bryant ..... A47C 23/0522 5/719  
 2005/0091750 A1 \* 5/2005 Radice ..... A47C 27/144 5/655.9  
 2007/0261173 A1 \* 11/2007 Schlusssel ..... A47C 31/006 5/725  
 2007/0277323 A1 \* 12/2007 Bain ..... A47C 27/006 5/699  
 2008/0028522 A1 \* 2/2008 Atwood ..... A47G 9/0246 5/496  
 2013/0125305 A1 \* 5/2013 Fazio ..... A47C 21/003 5/400  
 2013/0219627 A1 \* 8/2013 Myers ..... A47C 31/00 5/694

\* cited by examiner

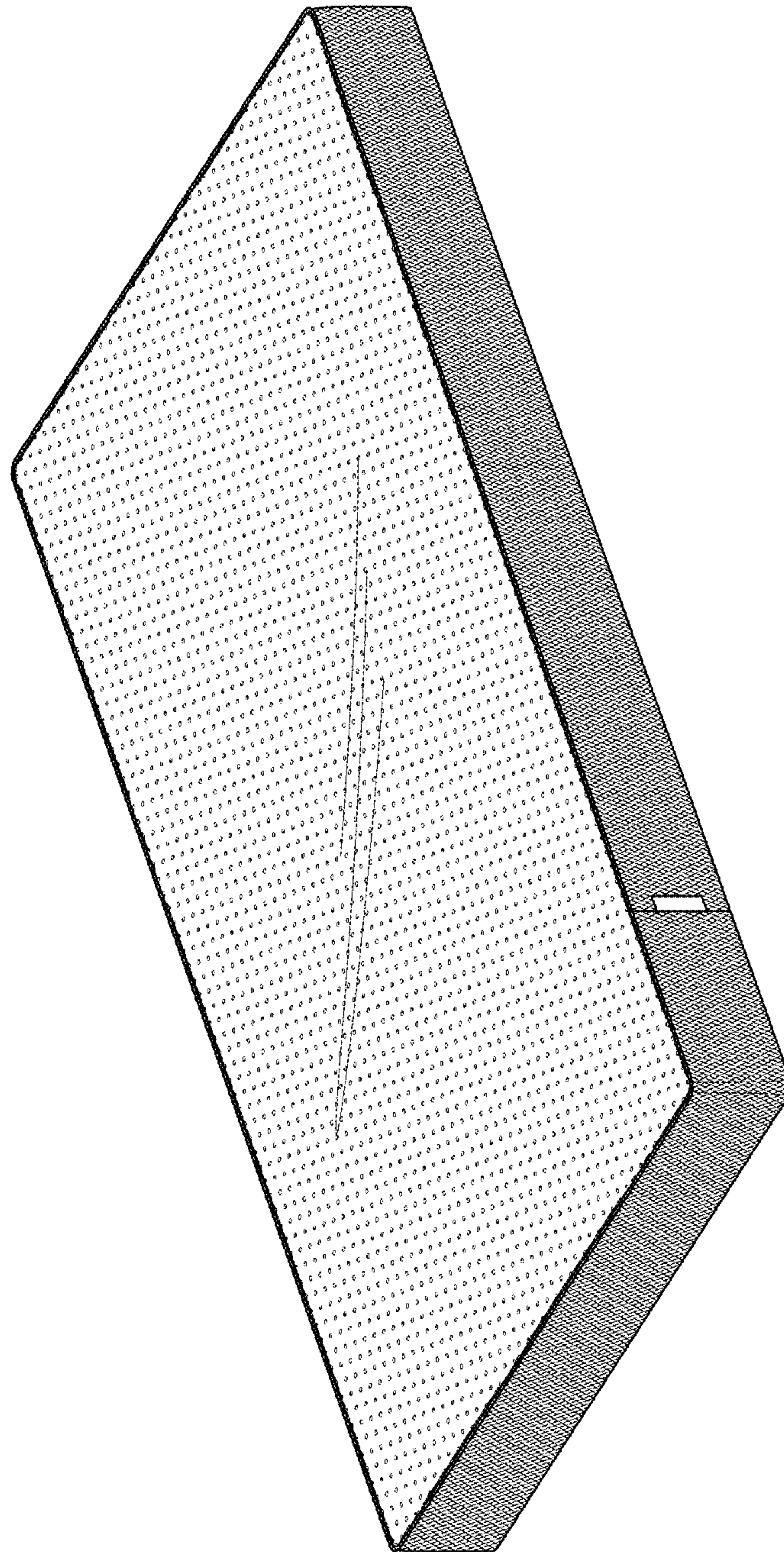

FIG. 1

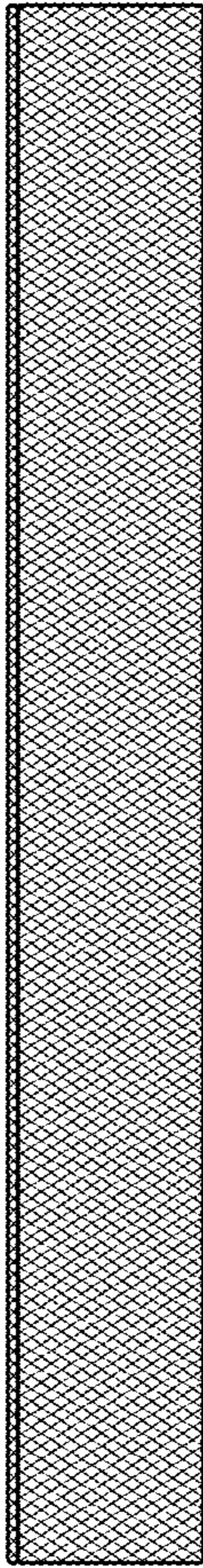

FIG. 2

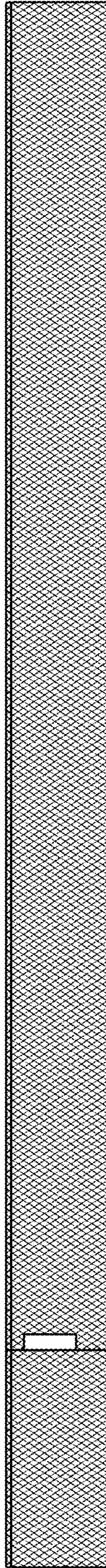

FIG. 3

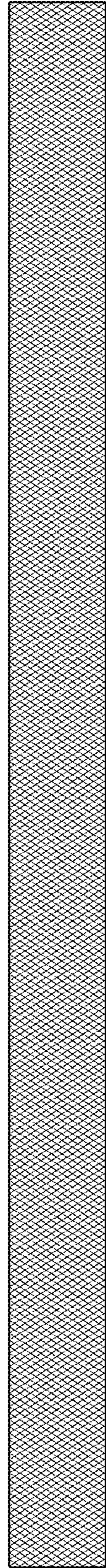

FIG. 4

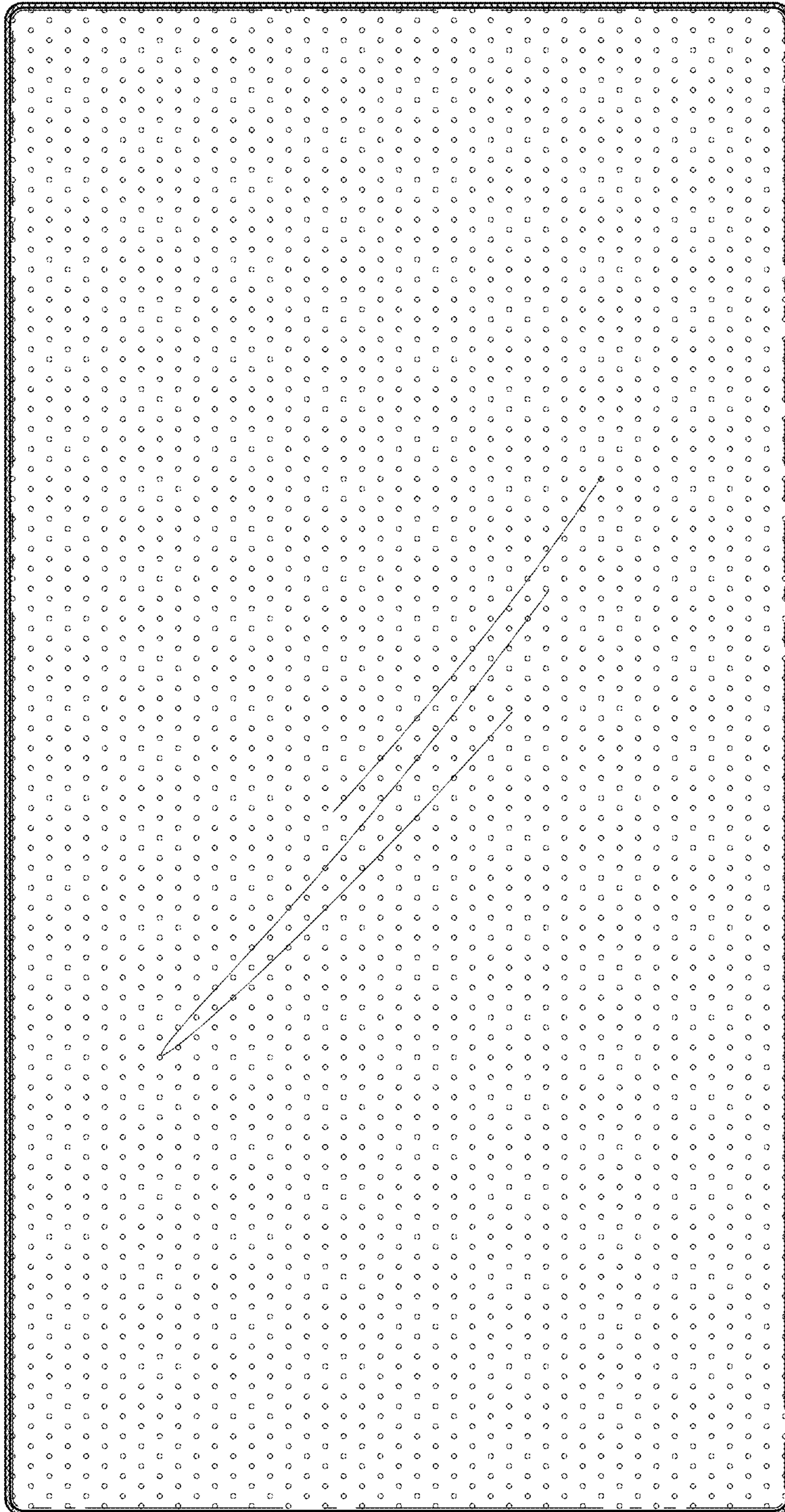

FIG. 5

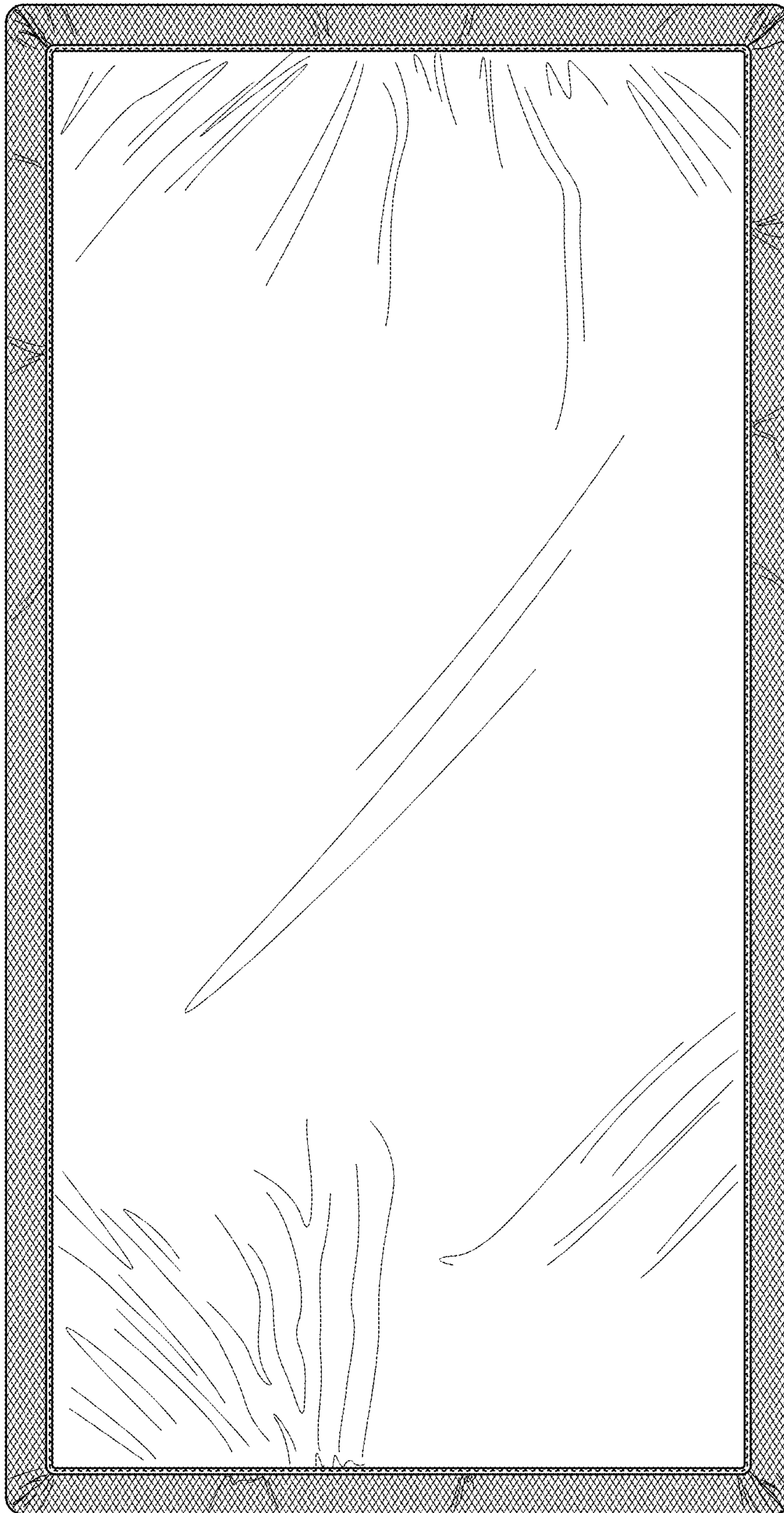

FIG. 6

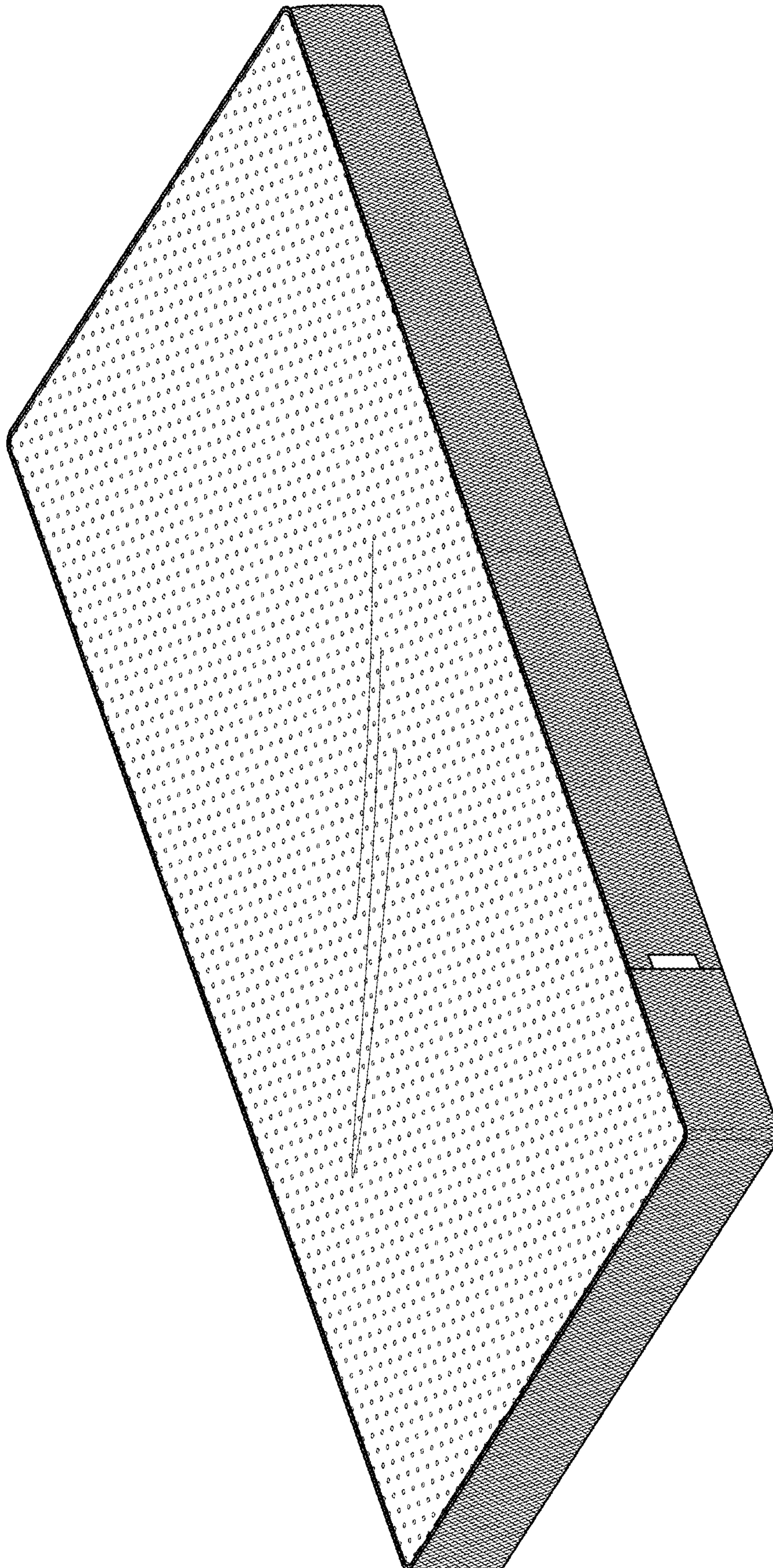

FIG. 7

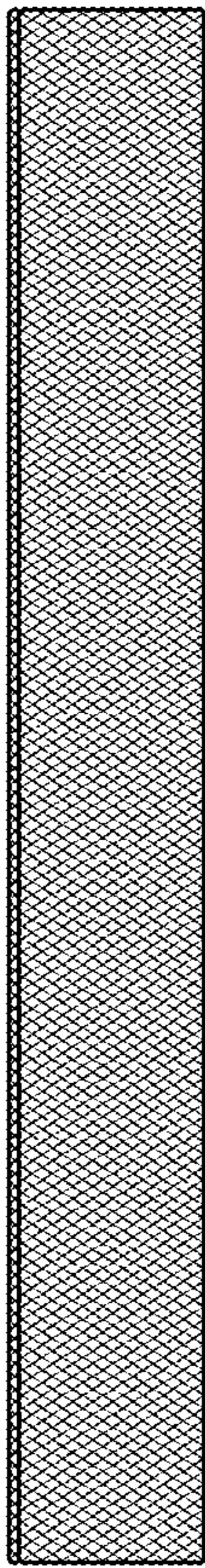

FIG. 8

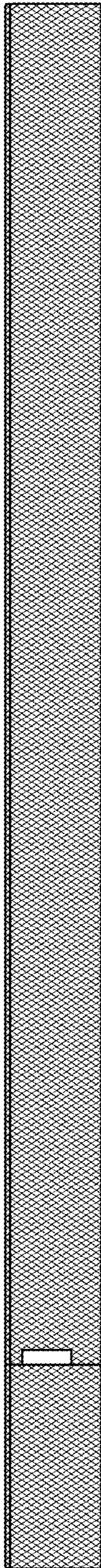

FIG. 9

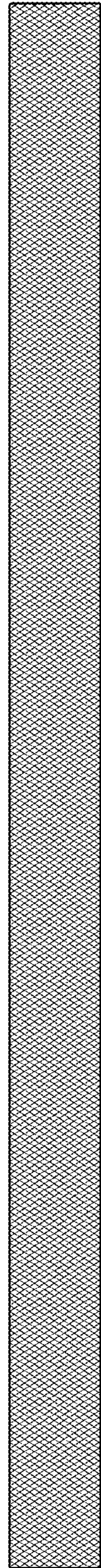

FIG. 10



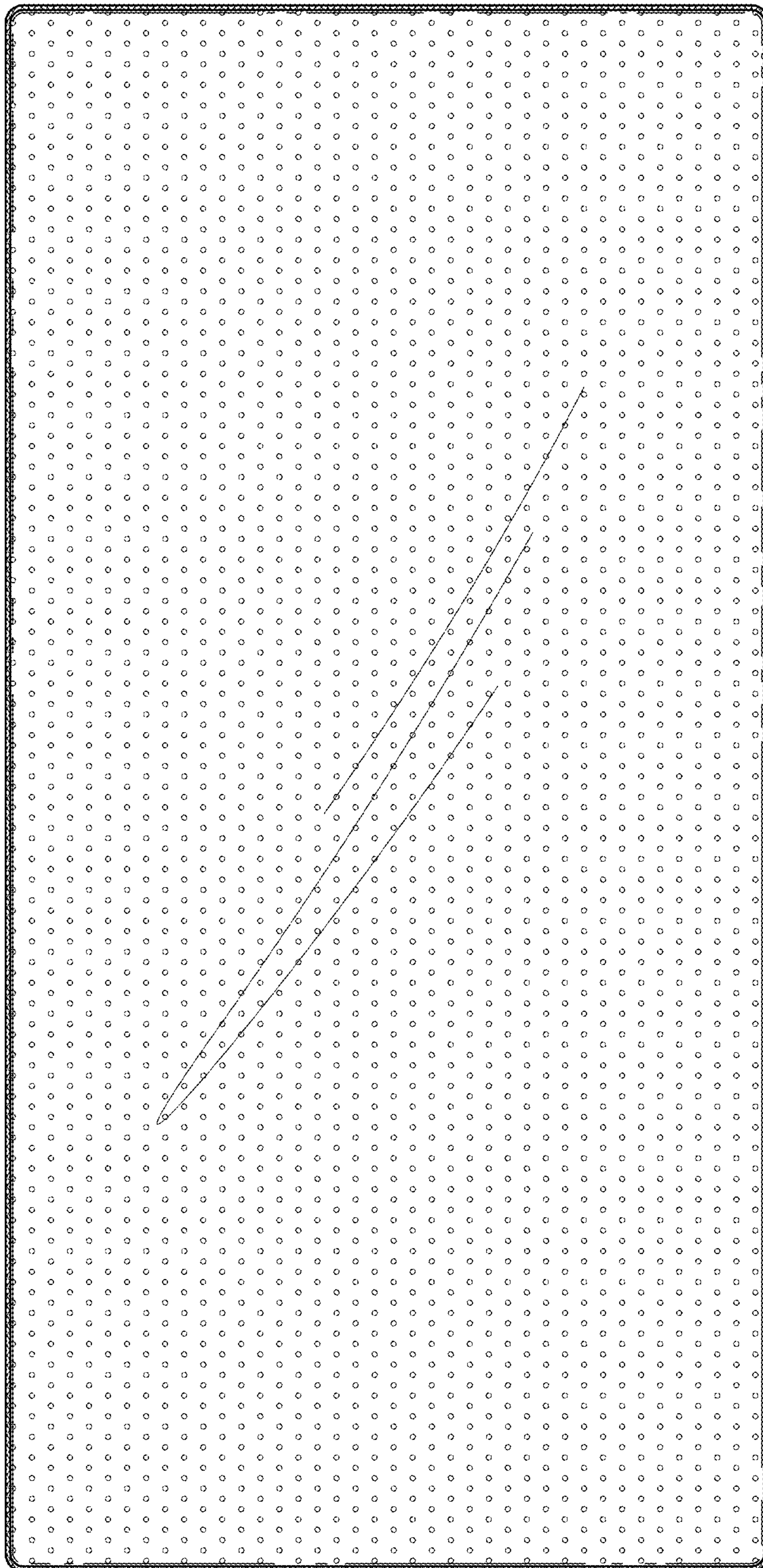

FIG. 11

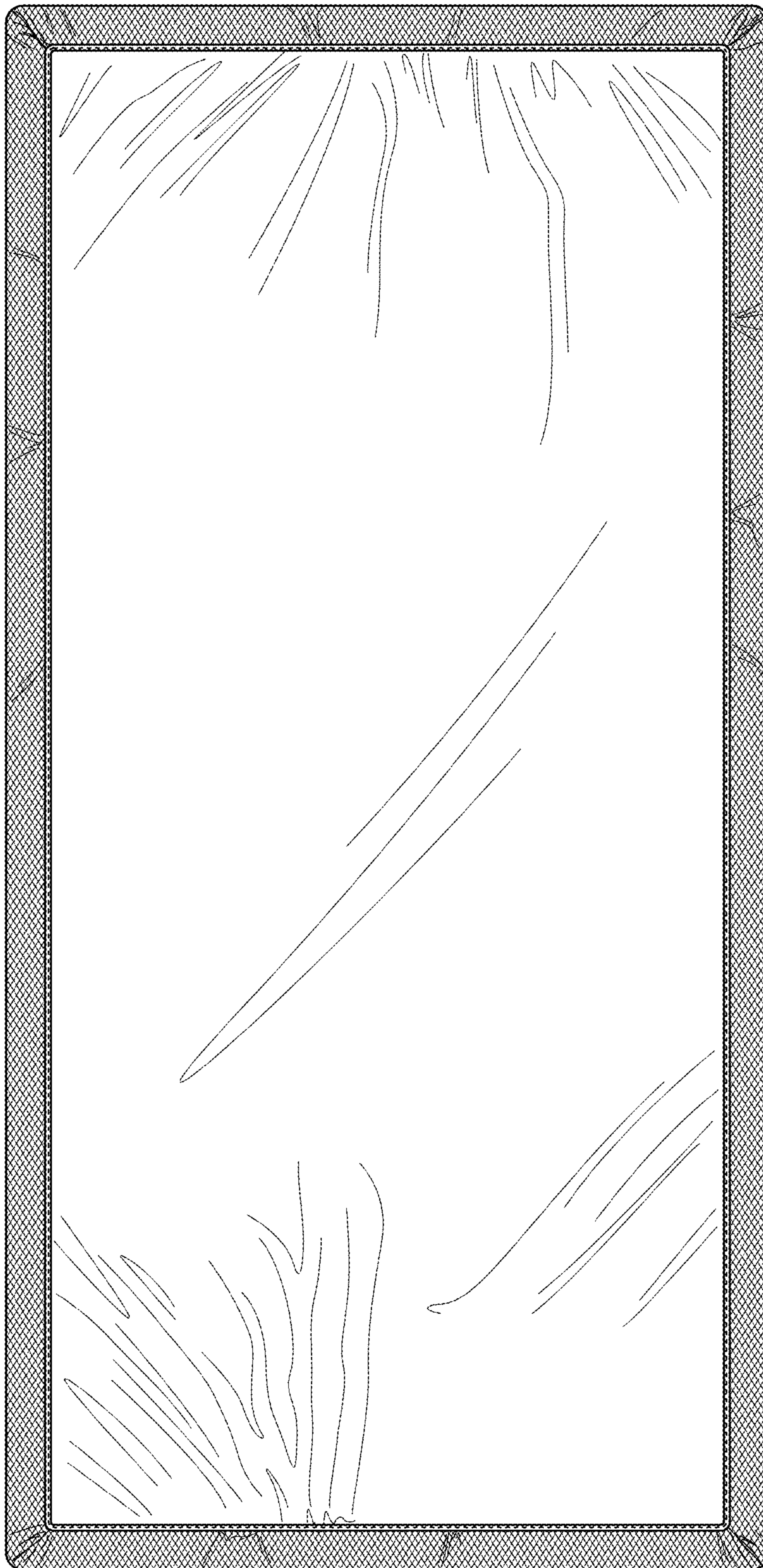

FIG. 12

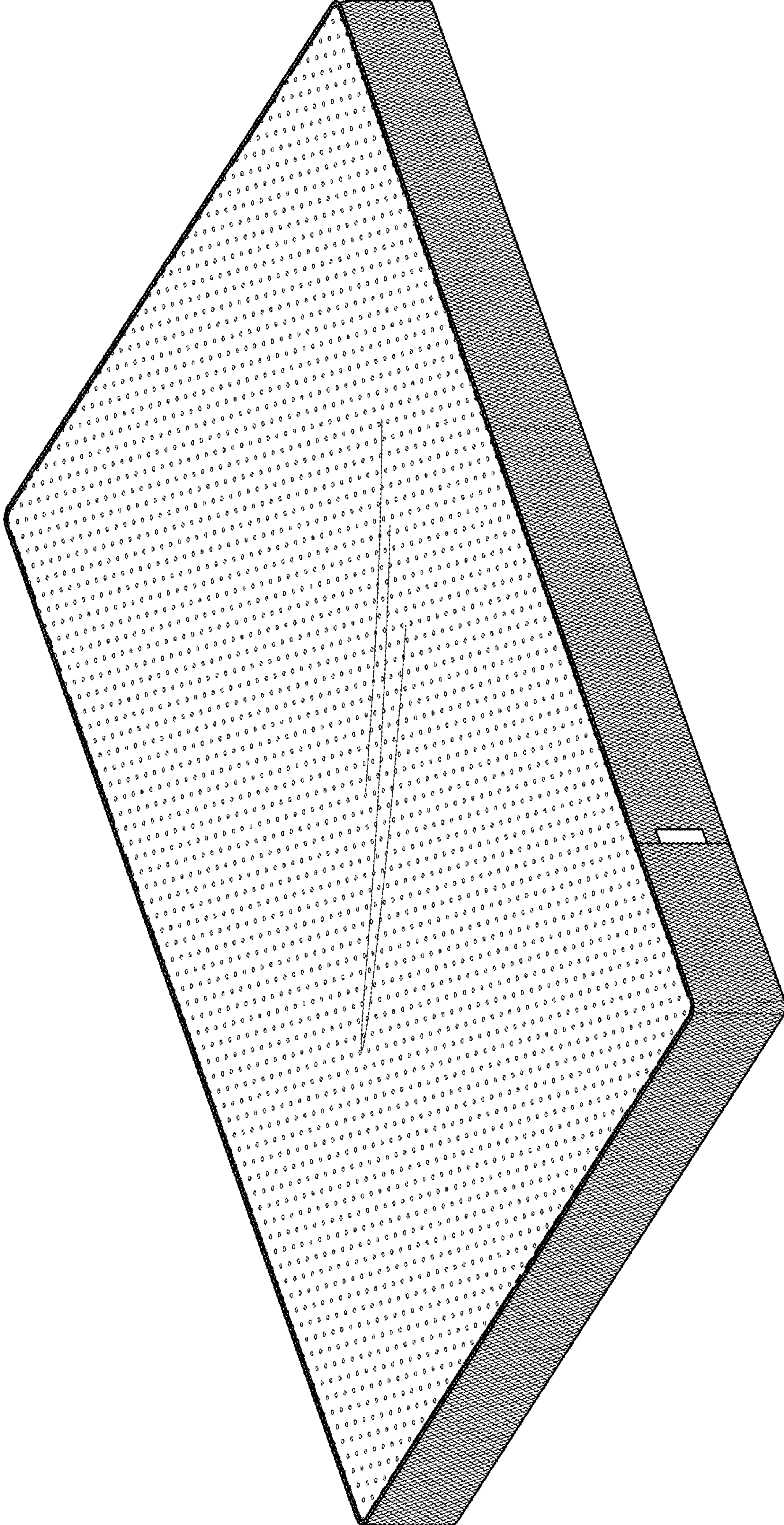

FIG. 13

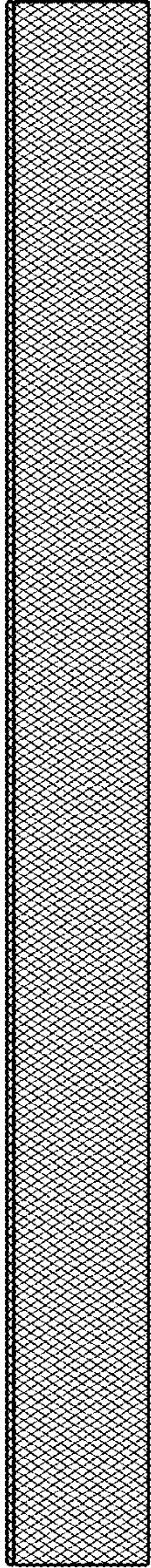

FIG. 14

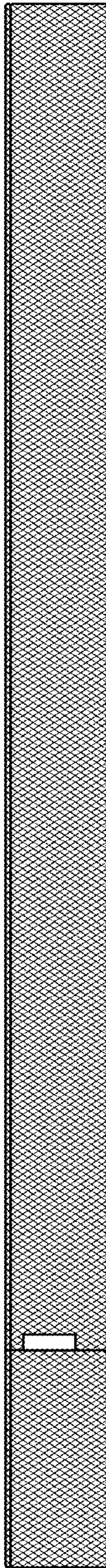

FIG. 15

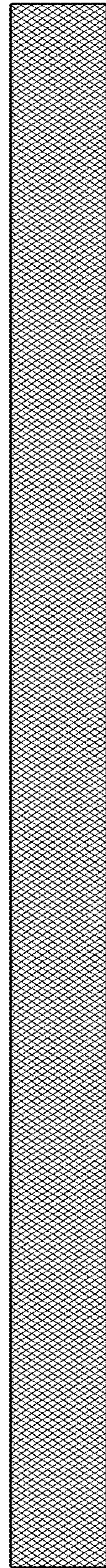

FIG. 16

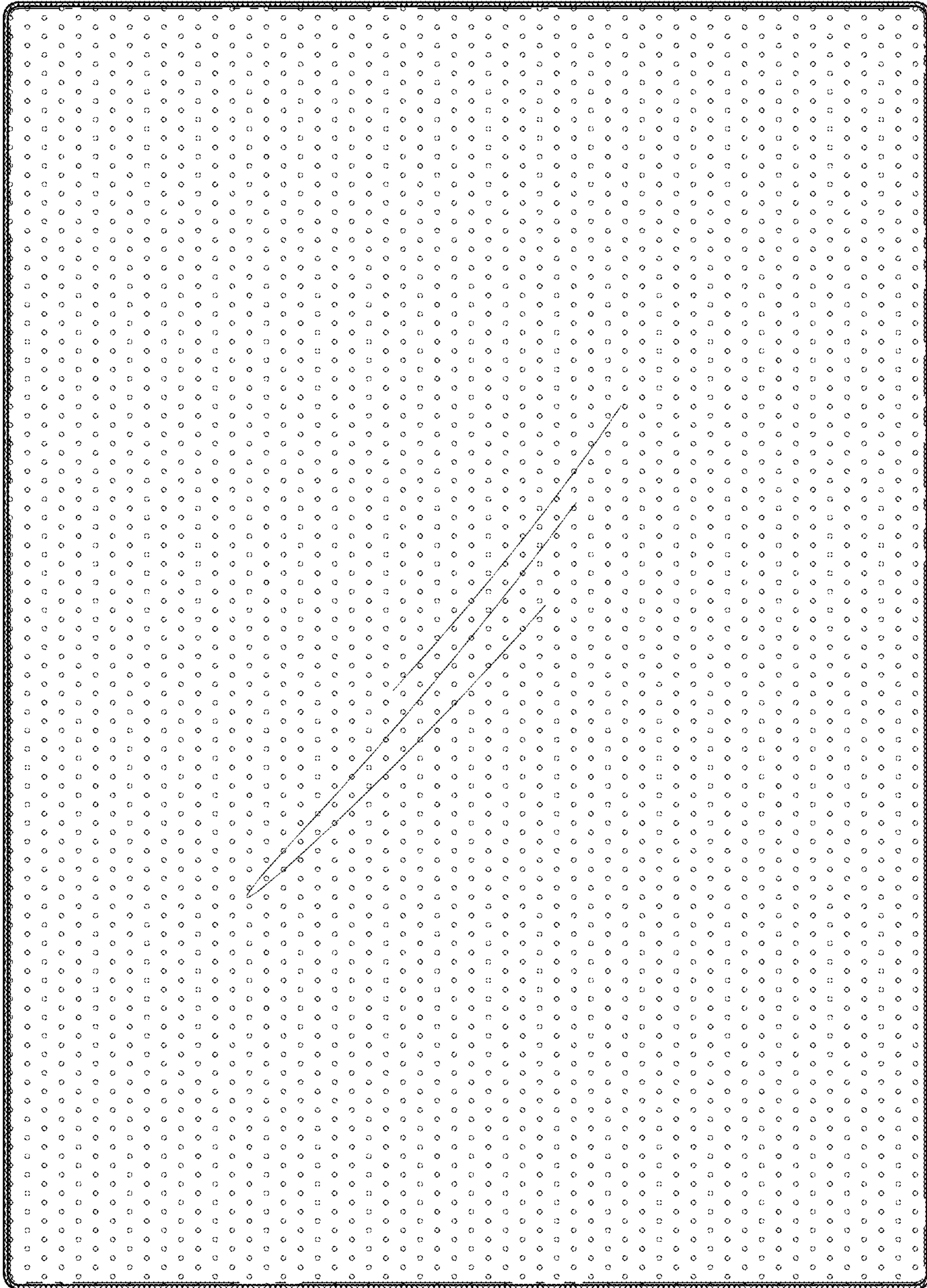

FIG. 17



FIG. 18

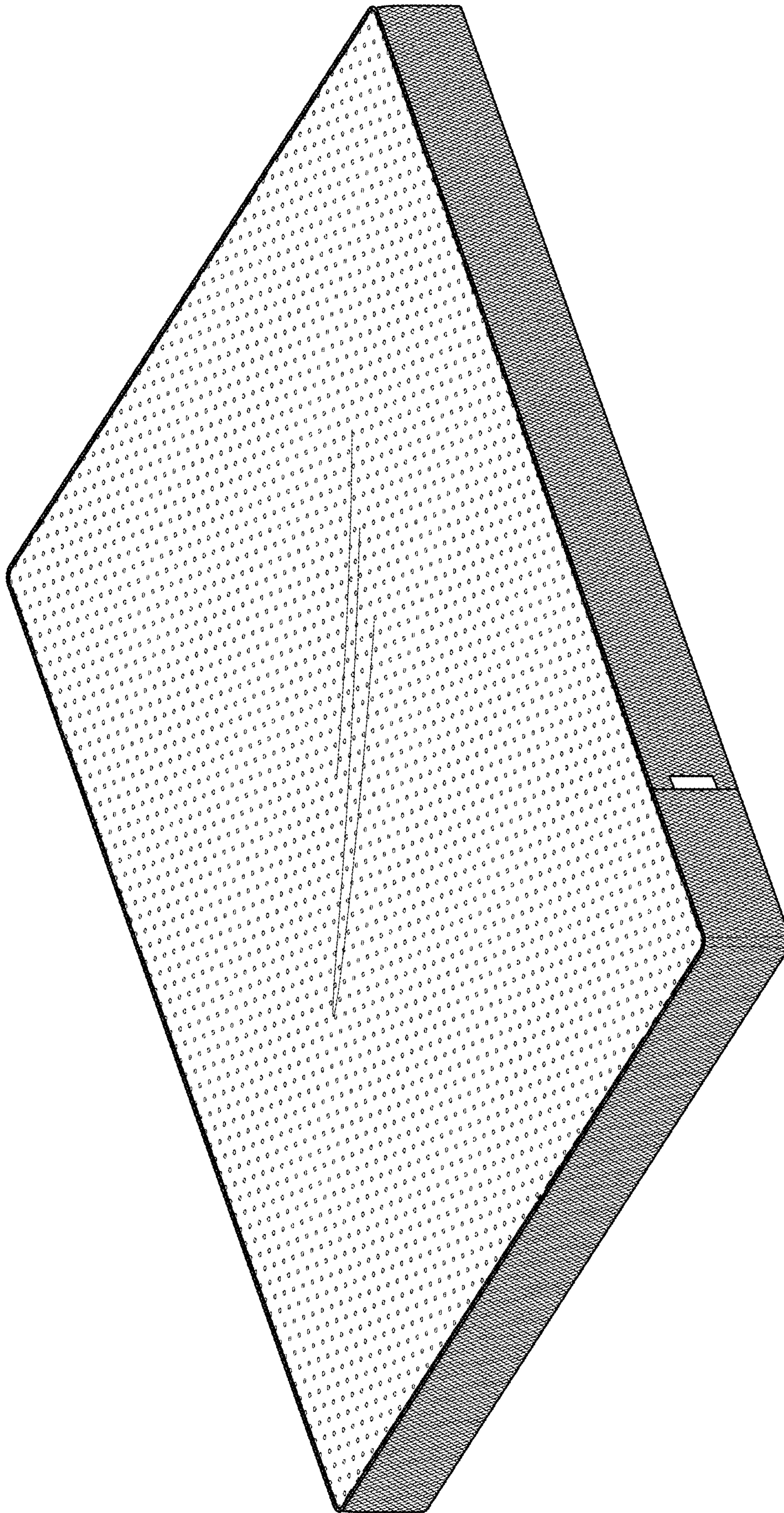

FIG. 19

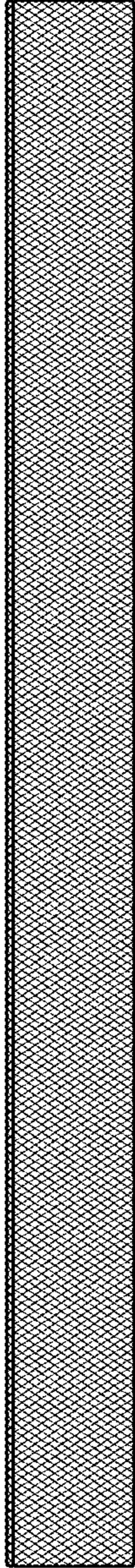

FIG. 20

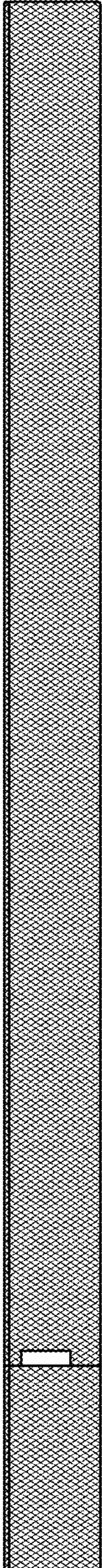

FIG. 21

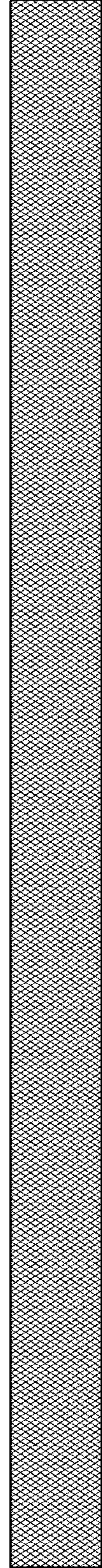

FIG. 22



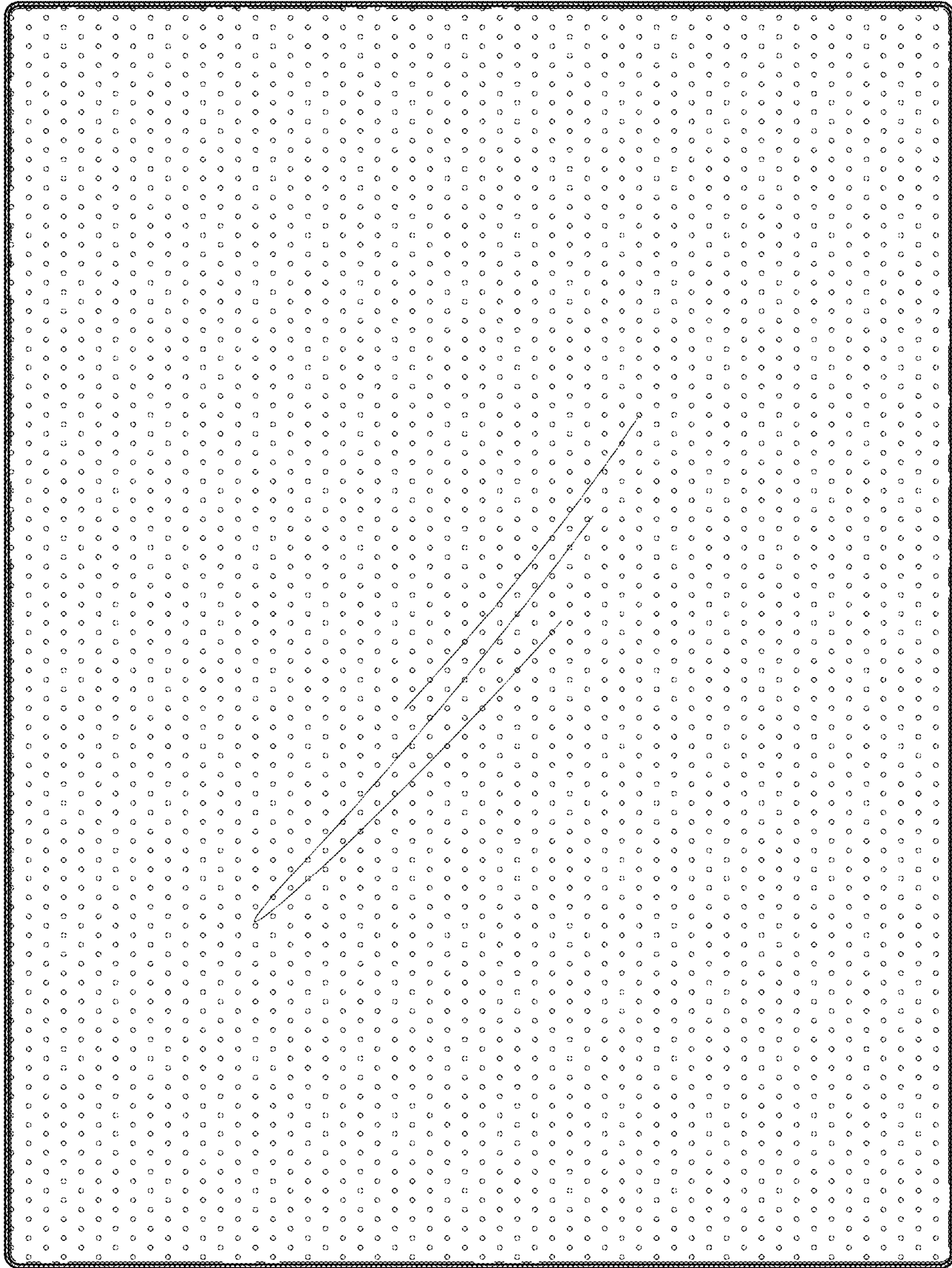

FIG. 23



FIG. 24

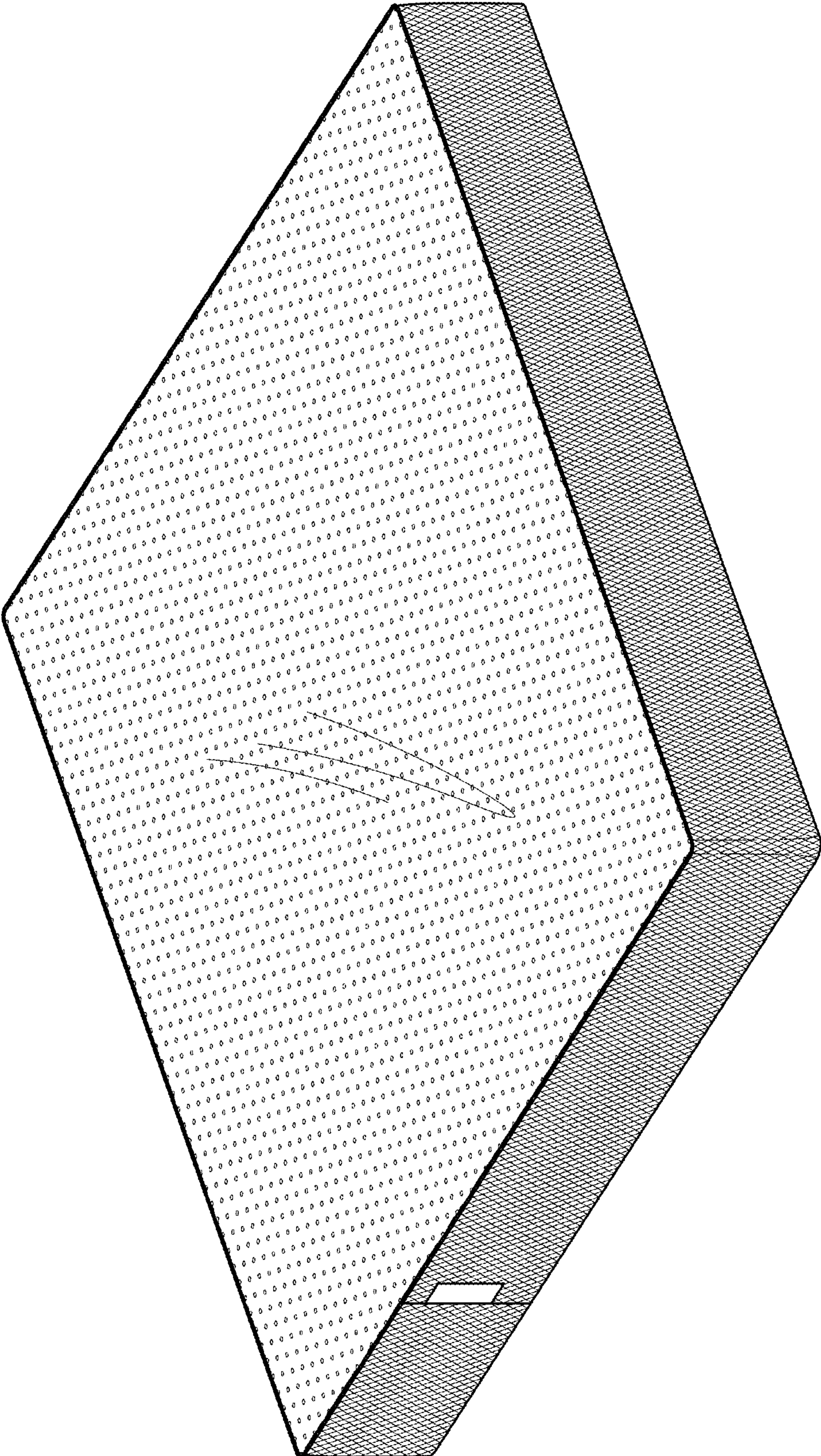

FIG. 25

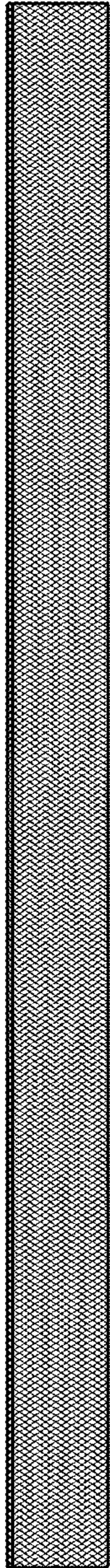

FIG. 26

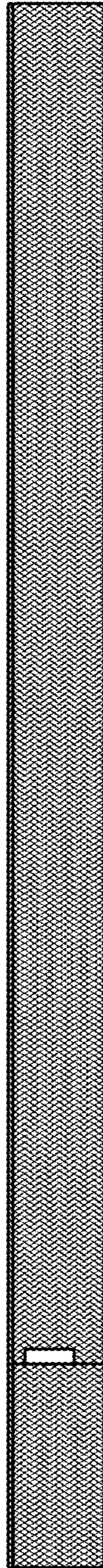

FIG. 27

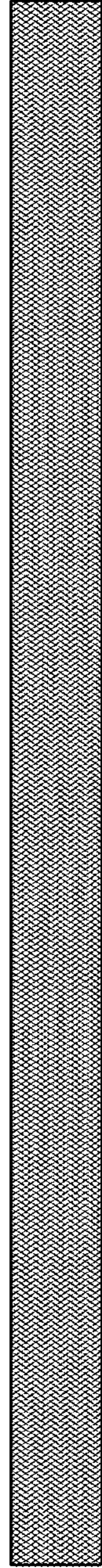

FIG. 28

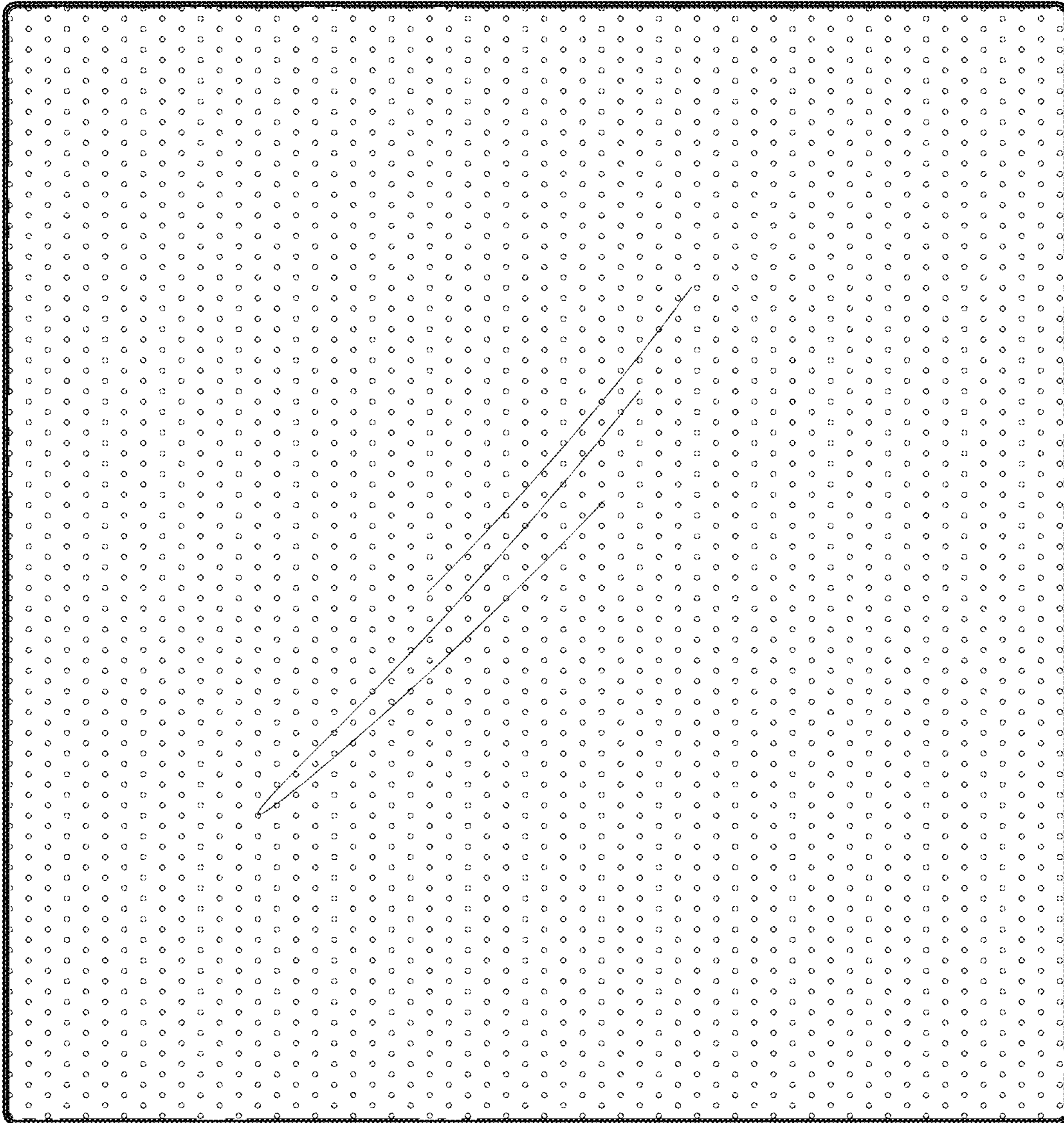

FIG. 29

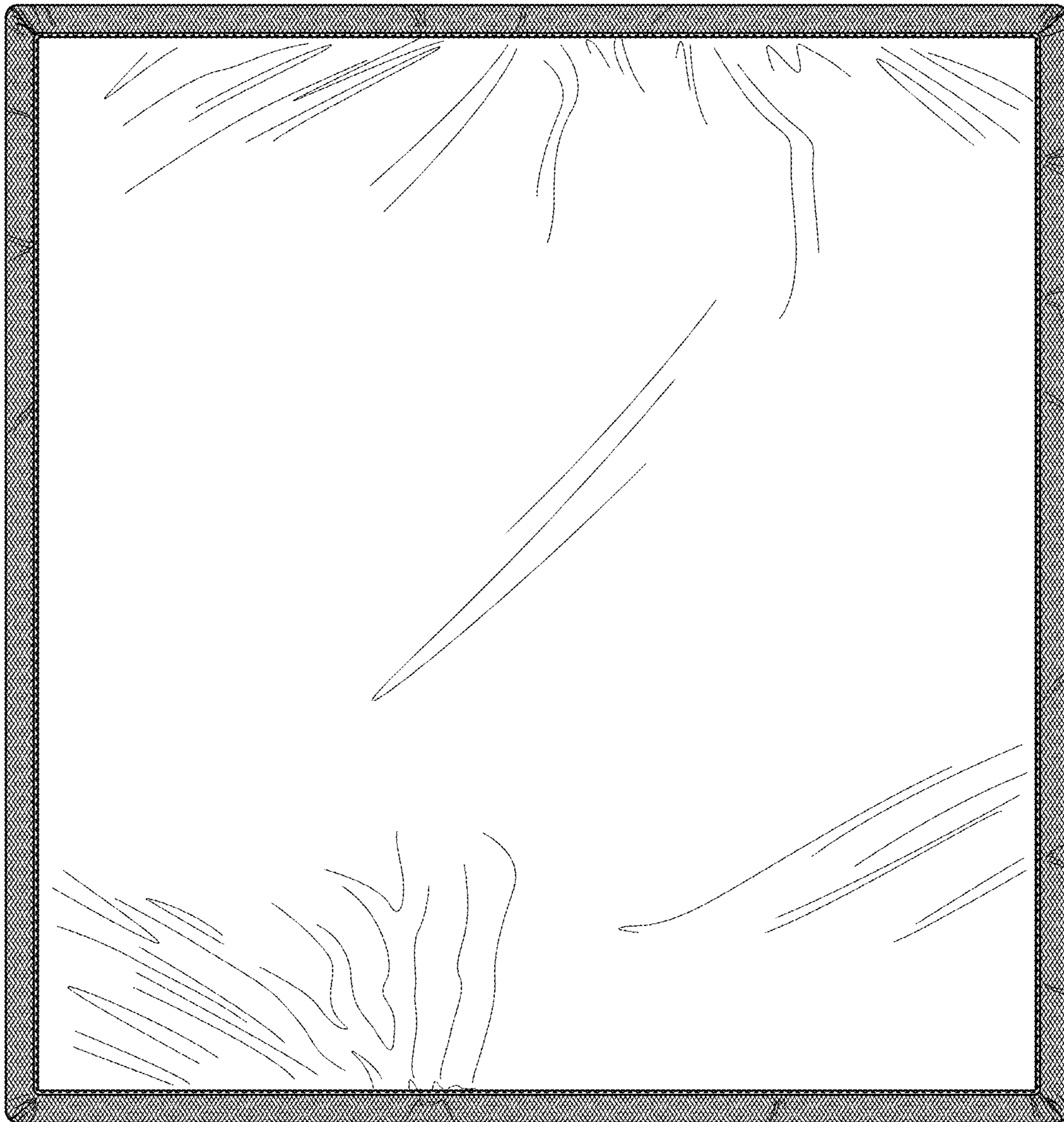

FIG. 30

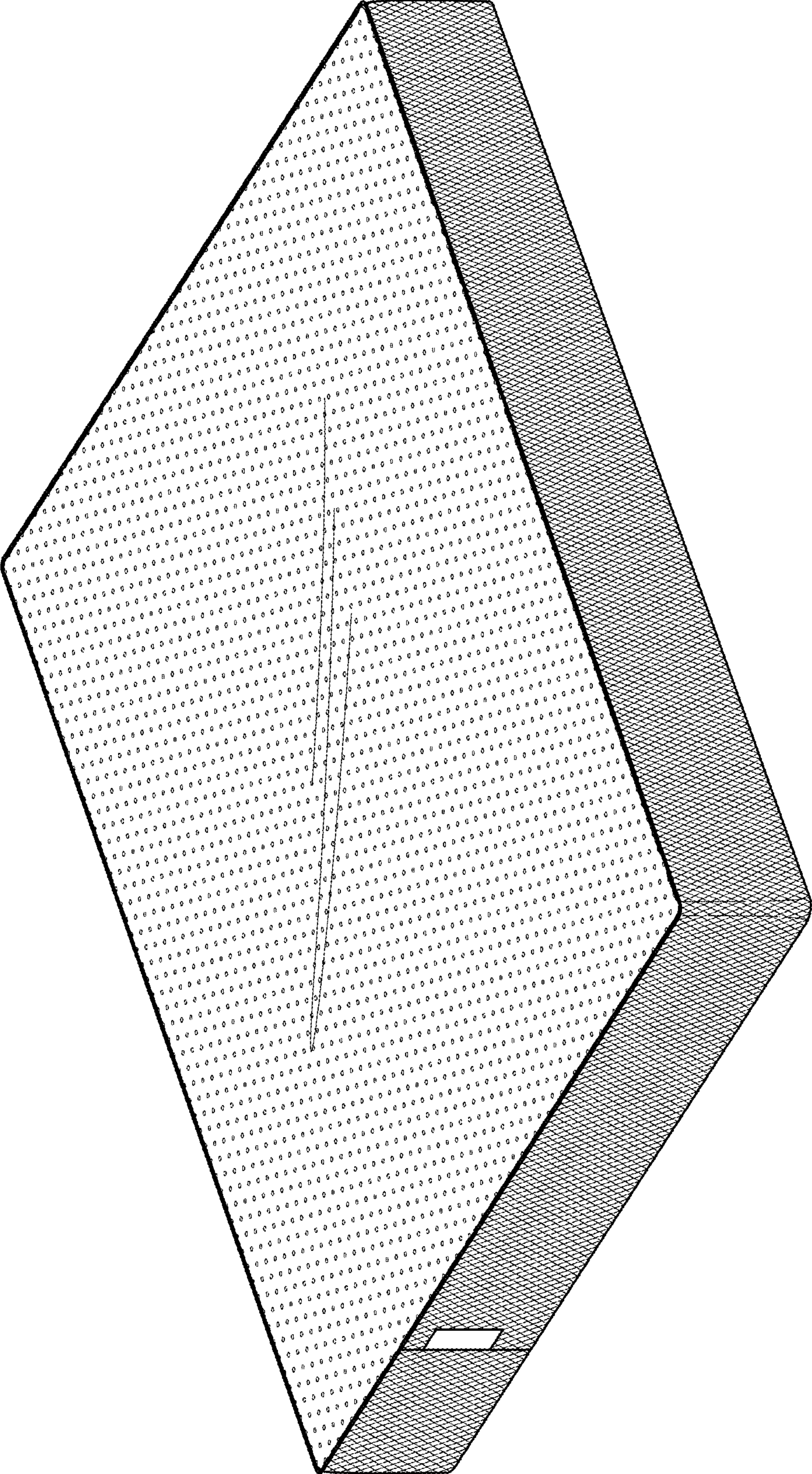

FIG. 31

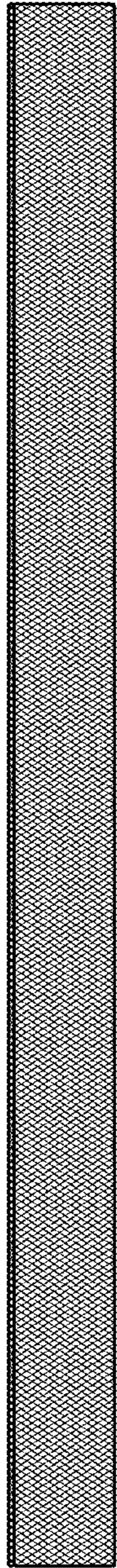

FIG. 32

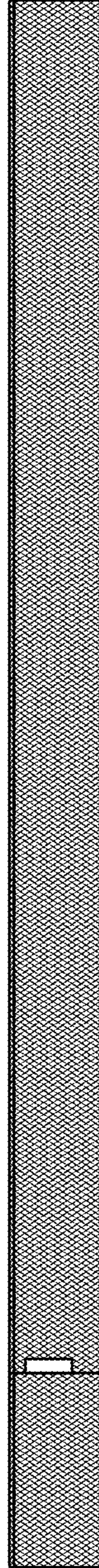

FIG. 33

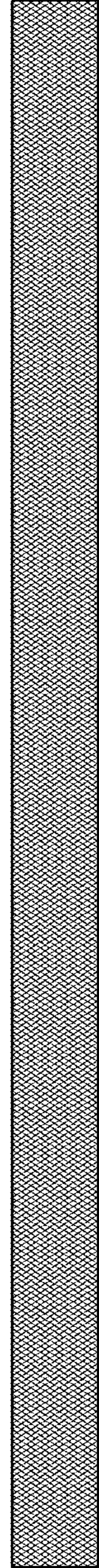

FIG. 34



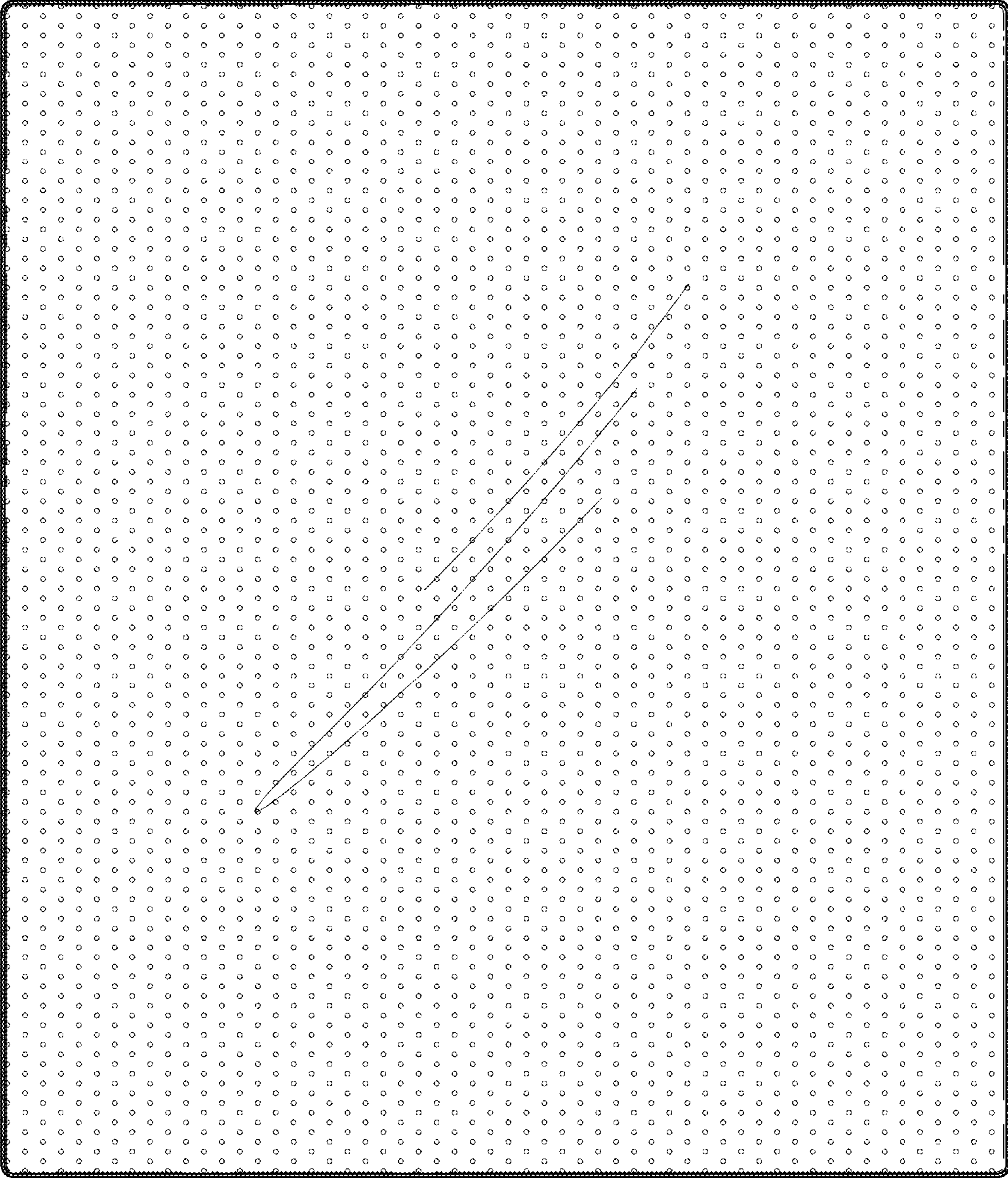

FIG. 35

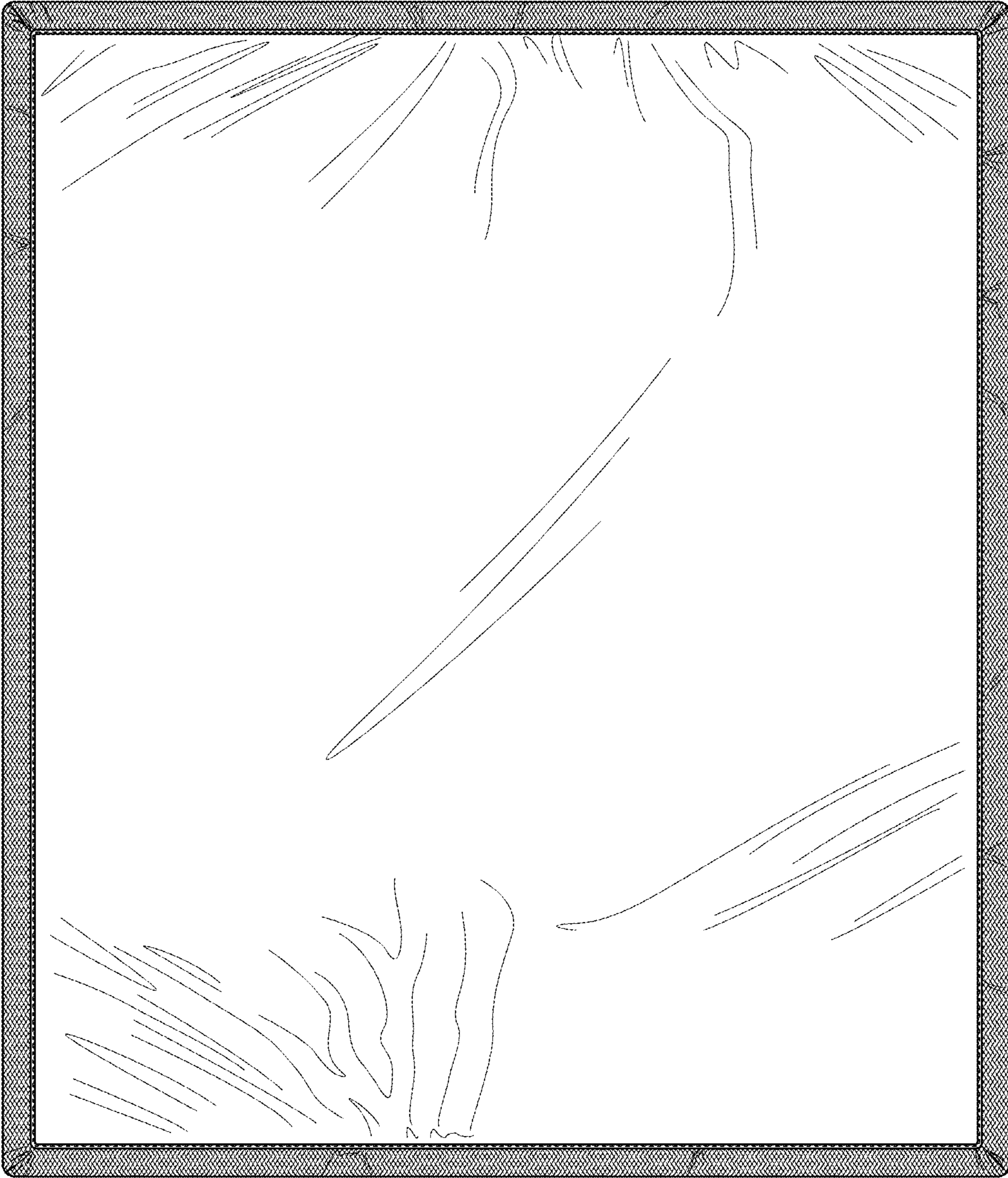

FIG. 36